

Picus[®] & Picus[®] NxT Electronic Pipette



Table of Contents

1. Introduction.....	3
1.1. Intended Use.....	4
1.2. Product Overview.....	4
1.2.1. Display.....	5
1.2.2. Optifit Tips and Safetyspace® Filter Tips.....	5
1.3. Contents of Delivery Package.....	6
2. Getting Started.....	6
2.1. Charging.....	7
2.2. Power Up.....	7
3. Operation.....	8
3.1. Operating Principles.....	8
3.2. Pipetting Modes.....	9
3.2.1. Pipetting (Forward Pipetting).....	10
3.2.2. Reverse Pipetting.....	10
3.2.3. Multi-Dispensing.....	11
3.2.4. Manual Pipetting.....	12
3.2.5. Diluting.....	13
3.2.6. Sequential Dispensing.....	14
3.2.7. Multi-Aspirating.....	14
3.2.8. Titration.....	15
3.2.9. Protocols (Only in Picus® Nxt).....	16
3.2.10. Advanced Functions.....	18
3.3. Saving Pipetting Programs to Memory.....	20
3.4. Setup.....	21
3.4.1. Adjustment.....	21
3.4.2. Sound.....	23
3.4.3. Backlight.....	23
3.4.4. User ID.....	24
3.4.5. GLP Info (only in Picus®).....	25
3.4.6. Reset.....	25
3.4.7. Information.....	25
3.4.8. Languages.....	26
3.4.9. Pipette Lock (only in Picus® Nxt).....	26
3.4.10. Passwords (only in Picus® Nxt).....	27
3.4.11. Date and Time (only in Picus® Nxt).....	28
3.4.12. Reminders (only in Picus® Nxt).....	28
3.4.13. Tip ejection.....	30
4. Maintaining the Pipette.....	30
4.1. Cleaning the Outer Surface of the Pipette (daily).....	31
4.1.1. Cleaning the Lower Part of a Single Channel Pipette (every three months).....	31
4.1.2. Multichannel Pipettes.....	33
4.2. Sterilizing.....	33
4.2.1. Autoclaving.....	33
4.2.2. UV Sterilization.....	34
4.3. Performance Testing.....	34
4.4. Replacing the Battery.....	35
4.5. Replacement Parts.....	35
4.6. Storage.....	35
5. Warranty.....	35
6. Hazardous Substances (RoHS II).....	36
7. Disposal (WEEE).....	36
8. Troubleshooting.....	36
8.1. Hardware Reset.....	36
8.2. Troubleshooting Guide.....	36
9. Technical Data.....	37
9.1. Performance Specifications.....	38
9.2. Speed Table.....	39

1. Introduction

The Sartorius Picus®|Picus® Nxt electronic pipette brings ergonomics to a completely new level with its exceptionally lightweight and compact design, and its ease of operation. This versatile air displacement pipette has been designed by an experienced R&D team in cooperation with laboratory personnel and ergonomists to ensure safe and comfortable pipetting.

The Picus®|Picus® Nxt is available in single and multichannel models (8 and 12-channel). Tips can be attached and ejected safely and comfortably using the Optiload tip-loading feature and the electronic tip ejection function. To improve safety by reducing the risk of contamination, replaceable Safe-Cone Filters can be used in all Picus®|Picus® Nxt models greater than 10 µl.

The fully electronic operation, unique DC motor, and the electronic brake and piston control system guarantee excellent accuracy and precision. The desired volume can be quickly selected using the light and easy-to-use adjustment wheel on top of the pipette.

Picus® Nxt offers advanced safety and efficiency features for highly regulated laboratories. These features include a certificate of accredited 3-point calibration, user-definable pipetting protocols, and calibration and service reminders.

Congratulations on becoming a new Picus®|Picus® Nxt owner!



reddot design award
winner 2012

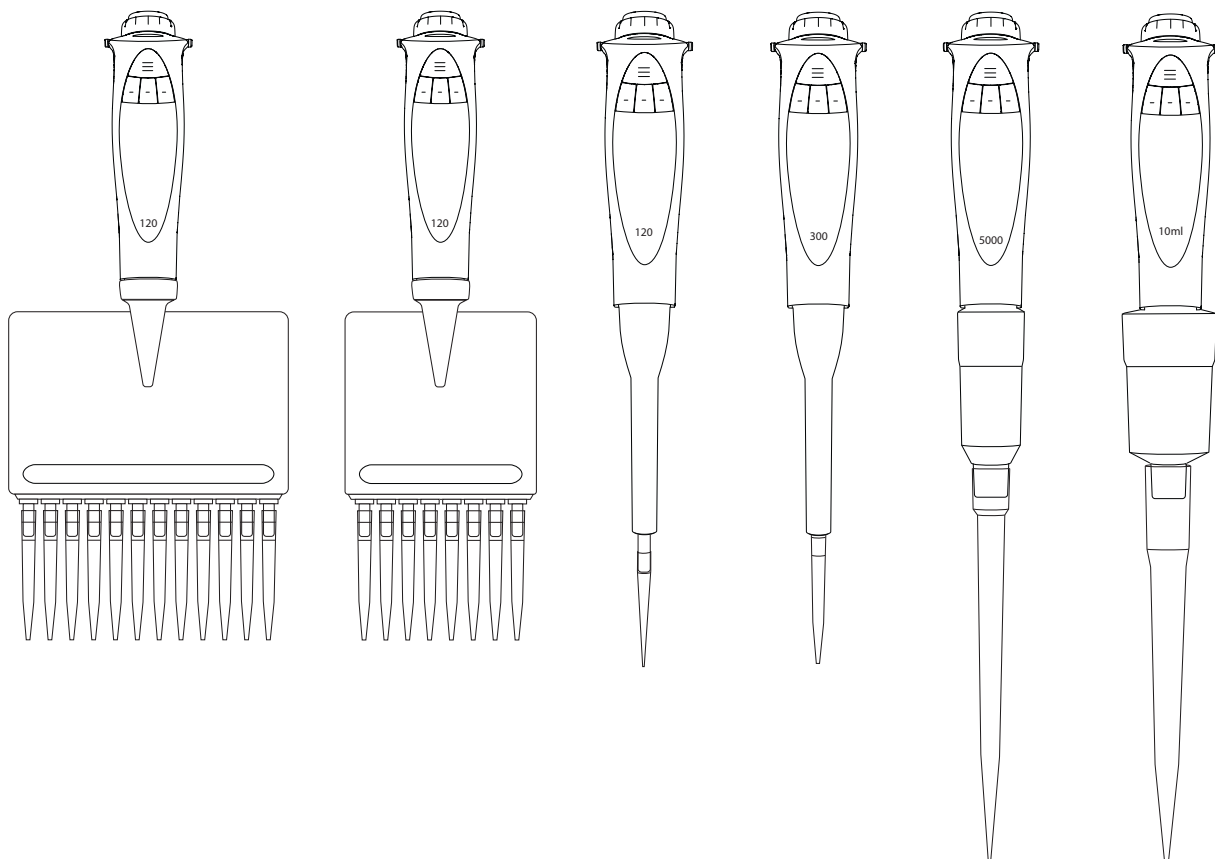

1.1. Intended Use

The Picus®|Picus® Nxt pipette is intended, designed and manufactured for dispensing liquids in a variety of applications, and to be used in combination with Sartorius Optifit Tips or Safetyspace® Filter Tips.

The Picus®|Picus® Nxt product range covers a volume range of 0.2 µl to 10,000 µl. It is recommended that Sartorius Optifit Tips or Safetyspace® Filter Tips are used with Sartorius pipettes to ensure optimum compatibility and performance.

The Sartorius Picus®|Picus® Nxt pipette is a general purpose laboratory device that is developed and manufactured according to ISO 9001 and ISO 13485 standards.

Read this user manual carefully before using the pipette for the first time. Additional copies can be downloaded from www.sartorius.com or by email from lhinfo.finland@sartorius.com.

Note: Prolonged pipetting can cause Work Related Upper Limb Disorder (WRULD). The manufacturer is not responsible for WRULD or any related injuries caused by using pipettes.

1.2. Product Overview

1. Electronic tip ejector
2. Charging contacts
3. On/off button
4. USB-charging port
5. Operating button & volume range colour-code
6. Adjustment wheel
7. Hotkey for memory places (black in Picus® Nxt)
8. Softkeys for programming (black in Picus® Nxt)
9. Dot-matrix display
10. Maximum volume
11. Dispensing head (tip ejector collar and tip-cone), autoclavable (excl. 8/12-ch 1,200 µl)
12. Optiload, spring-loaded tip-cones in multichannel pipettes
13. Safe-Cone Filters (excl. <10 µl pipettes)
14. Pipette tip
15. Tip ejector collar. (When using non-Sartorius tips, it can be adjusted for suitable tip ejection, in 10 µl, 120 µl, 300 µl and 1,000 µl single-channel models)

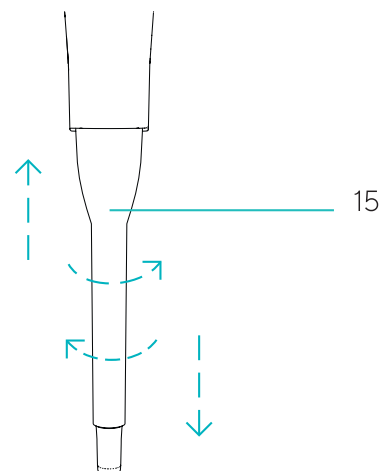
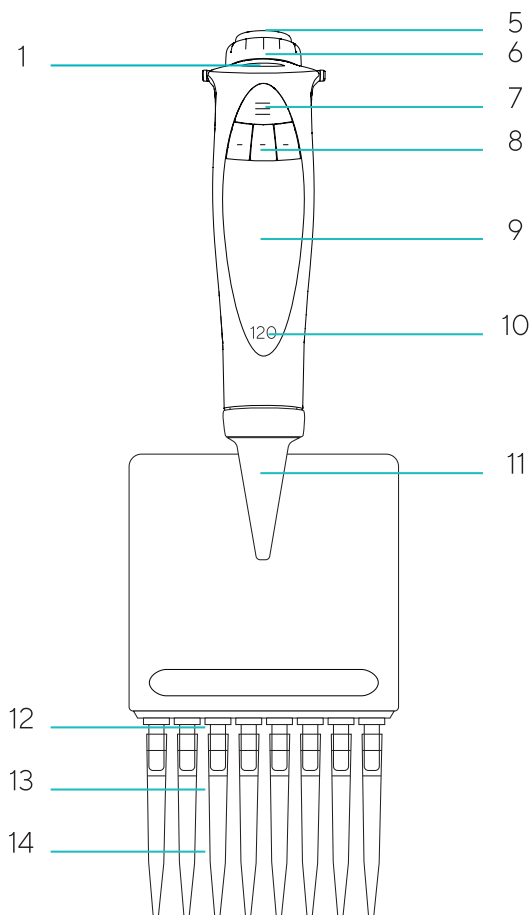
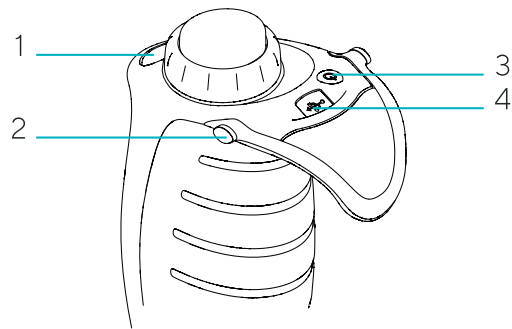

1.2.1. Display

The multi-colour backlit dot-matrix display is clear and is logically structured.

1. Softkey functions
2. Current mode
3. Pipetting volume and aliquots in multi-dispensing mode
4. Advanced Function (ADV), if selected
5. Speed
6. Battery indicator
7. Arrow indicating pipetting direction

1.2.2. Optifit Tips and Safetyspace® Filter Tips

We recommend using Sartorius Optifit Tips or Safetyspace® Filter Tips. These tips are designed for Sartorius pipettes and therefore ensure optimal compatibility, accuracy, and precision.

For optimum results you should also:

- Ensure that the liquid and the pipette|tip combination are at approximately the same temperature
- Choose the right tip volume for your pipette: the colour of the tip tray should match the colour code on the pipette
- Use Optifit Tips in rack, refill, or bulk packaging, and choose the purity level your application requires: free of DNase, RNase, human DNA and endotoxin, and/or sterilized
- If aerosol contamination needs to be avoided, choose Safe-Cone Filters, which are attached to the tip-cone and should be changed daily, or Safetyspace® Filter Tips, which are discarded after each pipetting
- Safetyspace® Filter Tips should also be chosen when you want to avoid sample loss due to the sample reaching the filter. The extra space between the sample and the filter ensures that even foaming or viscous liquids don't reach the filter in reverse pipetting or repetitive|multiple dispensing modes
- Pre-rinse the tip three to five times before pipetting (this is especially important in the forward pipetting mode)
- Wipe the tip against the receiving vessel's wall to catch the last droplet after dispensing
- Change the tip after every pipetting

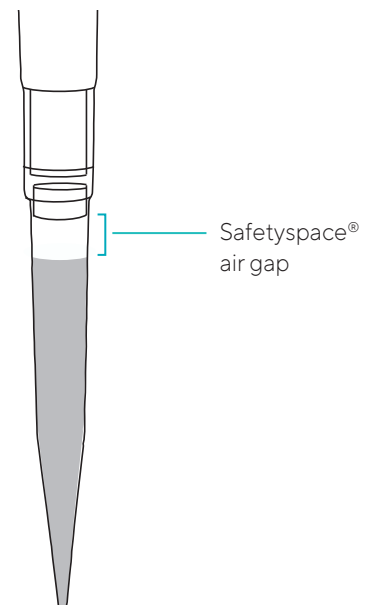
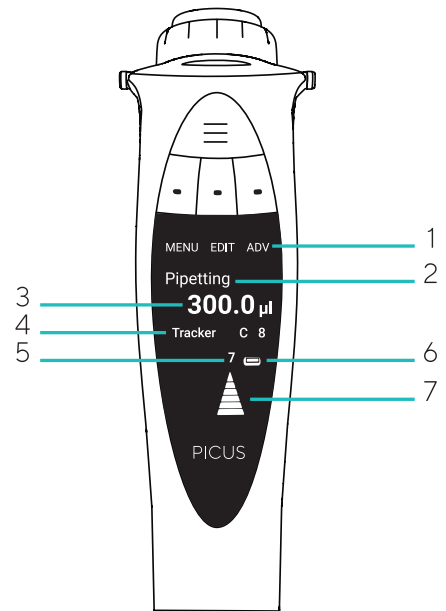

1.3. Contents of Delivery Package

- Picus®|Picus® Nxt electronic pipette
- Universal USB charger (EU, UK, US, JPN, KOR, AUS, and CHN plugs)
- Sartorius tip rack (10x96 tips) of corresponding volume with up to 1,000 µl single-channel models / 1,200 µl multichannel models
- One tip with 5,000 µl and 10,000 µl single-channel models
- Safe-Cone Filters and tweezers with >10 µl models
- Autoclavable grease with the single-channel models
- QC-certificate (Picus®), certificate of accredited 3-point calibration (Picus® Nxt)
- Quick Start Guide

If any item in this delivery package is missing or damaged, please contact your local Sartorius representative.

2. Getting Started

Please read this manual before using your Picus®|Picus® Nxt electronic pipette.

1. Picus®|Picus® Nxt pipettes are delivered ready for use, with the battery partially charged. However, for the best results we recommend fully charging the pipette for approximately one hour before first use.
2. Using the USB Charger: connect the charger to the pipette's USB socket, and plug the charger adapter into a power outlet (mains).
3. Using the charging stand or carousel: make sure the charging stand is connected to a power outlet (mains), and insert the pipette into the grooves on the charging stand so that the charging contacts meet.
4. Insert the replaceable Safe-Cone Filter(s) into the tip cone(s) before use, to reduce the possible risk of the pipette becoming contaminated. Alternatively, you may use filter tips.
5. Press the on|off button on top of the pipette to turn the power on.
6. Press the tip ejector when indicated by the display.
7. The pipette is now ready for programming and use.

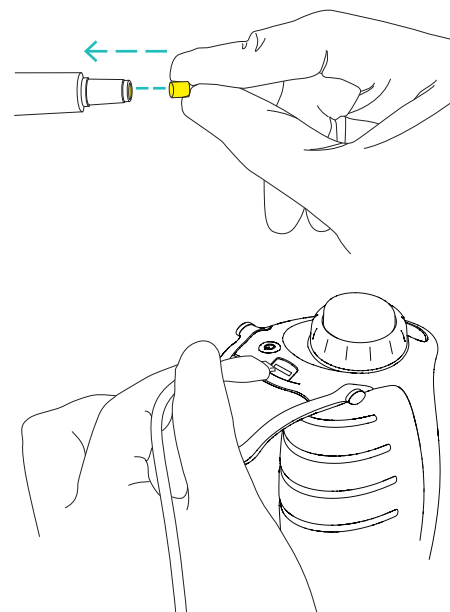

2.1. Charging

It is recommended that you charge the pipette before first use for one (1) hour.

- **Charging via USB:**
Connect the USB cable to the pipette and plug the charger into the mains power outlet.
- **Charging using charging stand or carousel:**
Make sure that the charging stand is connected to the mains power outlet via the AC charger, and that the charging contacts of the pipette are properly in contact with the charging grooves of the charging stand.

Charging options for Sartorius electronic pipettes:

- USB charger, universal, included in the package
Sartorius Charging Stand for one pipette, order code: 730981
- Sartorius Charging Carousel for four pipettes, order code: 730991

The battery sign in the bottom right corner of the display indicates the battery's level of charge. When the battery is low, the indicator blinks **Low** and the pipette needs to be charged.

Note: Before connecting the AC charger to the charging stand and the mains electrical outlet, make sure that the power supply output voltage level and power capacity are correct. The use of incorrect power supplies may damage the device. Only use the power supplies recommended by the manufacturer.

2.2. Power Up

1. Press **on|off** button: pipette will turn on.
2. Press the tip ejector button as advised on the display. The pipette is now ready to be programmed and used.
3. While being used and/or charged, the pipette is in active mode, all the processor functions are activated and the display backlight is on.
4. One minute after last activity the pipette will switch to power saving mode and the backlight will dim. The pipette returns to active mode when any buttons are pressed or if the adjustment wheel is turned.
5. 10 minutes after last activity the backlight turns off, but the display is still visible. The pipette returns to active mode when any buttons are pressed or if the adjustment wheel is turned.
6. 60 minutes after last activity the pipette turns off. To power up the pipette again, press either operating button or the **on|off** button. The pipette will also turn on when charged.

If the pipette is turned off from the **on|off** button, it can only be turned on by again using the same button.

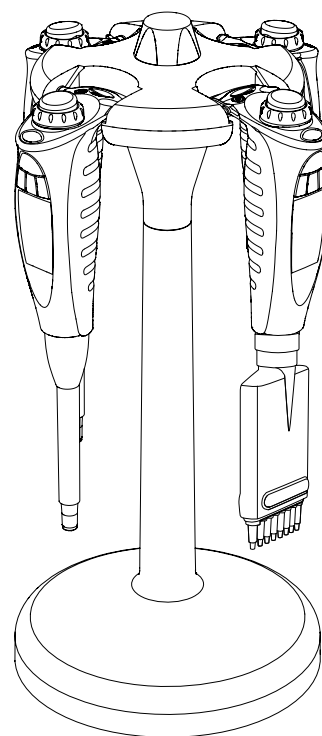
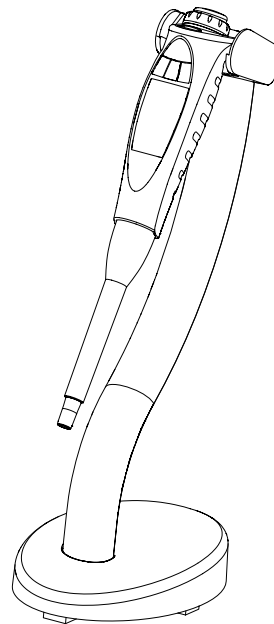

3. Operation

3.1. Operating Principles

Pipetting functions are controlled using the operating button, adjustment wheel, and Softkeys. The Hotkey is used to store or activate programs.

Operating button

- Confirms settings (can be used as an alternative to the Softkey for OK) and initiates piston movement for aspiration, dispensing and repeated blow-out.

Adjustment wheel

- Scrolls the menu and adjusts volume settings.
- Moves the piston in manual and titrating modes for aspiration and dispensing.
- Unlocks volume adjustment for editing when turned fully in one direction.

Electronic tip ejector

- Ejects the tip(s) with the light touch of a finger

Left Softkey

- Menu: Displays the main mode selection.
- Back: Exits the currently displayed, menu, edit, or ADV functions, without saving changes.
- Quit: Quits the pipetting task.
- Lock: Shown when reminders are triggered. Locks the pipette.

Middle Softkey

- Edit: Activates the editing mode so that settings can be changed.
- Next: Active in editing mode. Confirms a setting and moves to the next one.
- Save: Active in memory settings. Saves the current program to the selected memory place.
- ABC|abc|123|#@|clear: Active in memory settings and setup settings. Allows you to select letters, numbers, or symbols, or clear existing text.
- Reset: Active in the reminders menu. Resets the date and cycle counters.
- Prev: Active in editing mode. Moves back to the previous setting.
- Snooze: Shown when reminders are triggered. Snoozes the reminder.
- Unlock: Active when pipette is locked. Unlocks the pipette. If password protection is enabled, the administrator password is required.

Right Softkey

- ADV: Displays available advanced functions for the activated main mode.
- OK: Confirms the setting or selection and exits.

Hotkey

- 10 memory places to save and activate frequently used or favorite pipette settings.

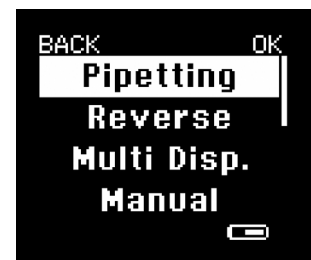

3.2. Pipetting Modes

The Picus® Nxt electronic pipette has nine (9) main pipetting modes, while the Picus® has eight (8). The Picus® Nxt has seven (7) advanced functions and the Picus® has six (6).

Pipetting Modes	Advanced Functions (ADV)*						
	Plate Tracker	Mixing	Counter	Excess Volume Adjustment	Auto-Dispensing	Fast Dispensing	Repeated Blow-out
Pipetting	■	■	■				■
Reverse Pipetting	■		■	■			
Manual Pipetting							■
Multi-Dispensing	■			■	■		
Diluting		■					■
Sequential Dispensing				■			
Multi-Aspiration							■
Titration						■	
Protocols**		■		■	■	■	■

* Advanced functions are used in conjunction with the pipetting modes.

** The availability of advanced functions varies according to the pipetting mode selected. Highlighted available in Picus® Nxt models.

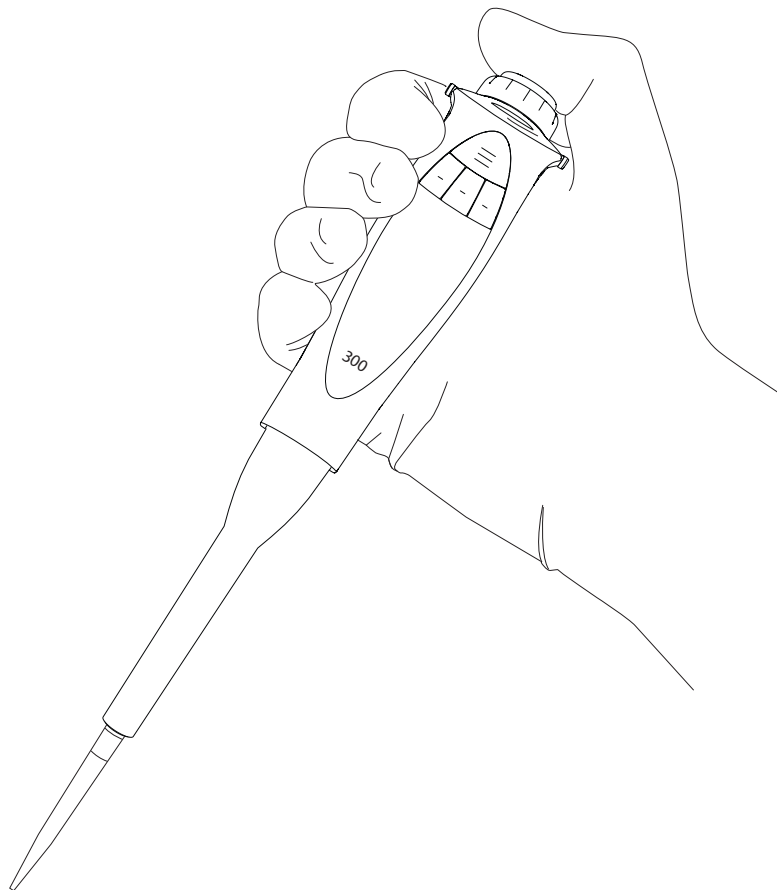

3.2.1. Pipetting (Forward Pipetting)

Pipetting mode aspirates and then dispenses the selected volume of liquid. It is recommended for aqueous liquids, liquids containing small amounts of detergent or proteins, and solvents.

To select Pipetting mode:

1. Select **menu** by pressing the left Softkey.
2. Confirm Pipetting mode by pressing the operating button or the right Softkey for OK. The latest settings used will then be displayed.

To edit the volume and speed settings:

1. Press the middle Softkey for **edit** or turn the adjustment wheel all the way to the right or left. The first setting to be edited is now highlighted.
2. Turn the adjustment wheel to set the desired value.
3. Confirm the setting by pressing
 - a. the operating button or the right Softkey for **OK**, which will exit the editing mode.

Or

 - b. the middle Softkey for **next**, to move on to edit the next highlighted setting.
4. Repeat steps 2 and 3 for all the settings you wish to edit.
5. To exit the editing mode without saving changes, press the left Softkey for **back**.

To use the pipette with the selected program:

1. Press the operating button to aspirate the liquid.
2. Press the operating button again to dispense the liquid.
3. Eject the tip by pressing the electronic tip ejector button.

Advanced Functions

Counter, Mixing, and Tracker can be used in conjunction with Pipetting mode. In Picus® Nxt, Repeated Blow-out can also be used. Repeated Blow-out helps to remove residual liquid from the tip, for liquids where normal dispensing does not empty it sufficiently.

- Counter counts the number of times a liquid is dispensed. Counting can be set to start at any number.
- Mixing mixes liquids manually or automatically. The mixing volume can be adjusted according to the pipette's maximum volume.
- Tracker displays the location to next dispense liquid in a microplate.

For more information on using advanced functions [see section 3.2.10](#).

Note: Only one advanced function can be selected at a time. Repeated Blow-out can be combined with other advanced functions.

3.2.2. Reverse Pipetting

Reverse Pipetting aspirates the selected volume as well as an excess volume. It is recommended for biological, foaming, and viscous liquids. In Reverse Pipetting mode the excess is left inside the tip and then discarded.

To select Reverse Pipetting mode:

1. Select **menu** by pressing the left Softkey.
2. Use the adjustment wheel to select Reverse and confirm by pressing the operating button or the right Softkey for **OK**. The latest settings used will then be displayed.

To edit the volume and speed settings:

1. Press the middle Softkey for **edit** or turn the adjustment wheel all the way to the right or left. The first setting to be edited is now highlighted.



Press the Softkey for menu

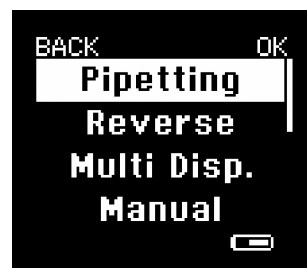

Choose the mode



Press the Softkey for edit



Change settings and press OK or next

2. Turn the adjustment wheel to set the desired value.
3. Confirm the setting by pressing
 - a. the operating button or the right Softkey for **OK**, which will exit the editing mode.
 Or
 - b. the middle Softkey for **next**, to move on to edit the next highlighted setting.
4. Repeat steps 2 and 3 for all settings you wish to edit.
5. To exit the editing mode without saving changes, press the left Softkey for **back**.

To use the pipette with the selected program:

1. Press the operating button to aspirate the liquid (selected volume + excess).
2. Press the operating button again to dispense the selected volume.
3. To continue reverse pipetting without discarding the excess volume, press the left Softkey for **no** and return to step 1.
4. To discard the excess volume and empty the tip, press the operating button twice.
5. Eject the tip by pressing the electronic tip ejector button.

Advanced Functions

Counter, Excess Adjustment, and Tracker can be used in conjunction with Reverse Pipetting.

- Counter counts the number of times a liquid is dispensed. Counting can be set to start at any number.
- Excess Adjustment can be used to set the excess volume. Otherwise a default value is used.
- Tracker displays the location to next dispense liquid in a microplate.

For more information on using advanced functions [see section 3.2.10](#).

Note: Only one advanced function can be selected at a time.

3.2.3. Multi-Dispensing

Multi-Dispensing aspirates the total volume as well as an excess volume, then repetitively dispenses equal volumes of liquid. It is recommended for long pipetting series and microplate dispensing.

To select Multi-Dispensing mode:

1. Select **menu** by pressing the left Softkey.
2. Use the adjustment wheel to select Multi-Disp and confirm by pressing the operating button or the right Softkey for **OK**. The latest settings used will then be displayed.

To edit the settings for volume, speed, and number of dispensings:

1. Press the middle Softkey for **edit** or turn the adjustment wheel all the way to the right or left. The first setting to be edited is now highlighted.
2. Turn the adjustment wheel to set the desired value.
3. Confirm the setting by pressing
 - a. the operating button or the right Softkey for **OK**, which will exit the editing mode.
 Or
 - b. the middle Softkey for **next**, to the next highlighted setting.
4. Repeat steps 2 and 3 for all settings you wish to edit.
5. To exit the editing mode without saving changes, press the left Softkey for **back**.



Dispensing 10 µl twelve times.

To use the pipette with the selected program:

1. Press the operating button to aspirate the liquid (selected volume + excess).
2. Press the operating button again to discard the prime excess.
3. Press the operating button repeatedly until all aliquots have been dispensed.
4. To continue repetitive dispensing without discarding the excess volume, press the left Softkey for **no** and return to step 1.
5. To discard the excess volume and to empty the tip, press the operating button twice.
6. Eject the tip by pressing the electronic tip ejector button.

Advanced Functions

Excess Adjustment, timed Automated Dispensing, and Tracker can be used in conjunction with Multi-Dispensing.

- Excess Adjustment can be used to set the excess volume.
- Timed Automated Dispensing dispenses automatically without needing the operating button to be pushed each time.
- Tracker displays the location to next dispense liquid in microplate dispensing.

For more information on using advanced functions [see section 3.2.10](#).

Note: Only one advanced function can be selected at a time.

3.2.4. Manual Pipetting

In Manual Pipetting the piston movement in aspiration and dispensing is controlled manually by turning the adjustment wheel. It is ideal for measuring reagents, and for applications in which the pipetting speed needs to be controlled manually.

To select Manual Pipetting mode:

1. Select **menu** by pressing the left Softkey.
2. Use the adjustment wheel to select Manual and confirm by pressing the operating button or the right Softkey for **OK**.

To edit the volume and speed settings:

1. Press the middle Softkey for **edit** or turn the adjustment wheel all the way to the right or left. The first setting to be edited is now highlighted.
2. Turn the adjustment wheel to set the desired value.
3. Confirm the setting by pressing
 - a. the operating button or the right Softkey for **OK**, which will exit the editing mode.

Or

 - b. the middle Softkey for **next**, to move on to edit the next highlighted setting.
4. Repeat steps 2 and 3 for all settings you wish to edit.
5. To exit the editing mode without saving changes, press the left Softkey for **back**.

To use the pipette with the selected program:

1. Press the operating button to begin aspiration.
2. To aspirate the liquid, press the operating button again and hold it down, or turn the adjustment wheel to the right. The aspiration speed can be adjusted by how far the adjustment wheel is turned. To pause aspiration, briefly release the operating button or adjustment wheel.
3. To begin dispensing, turn the adjustment wheel to the left. Hold the adjustment wheel to the left or press the operating button down to continue dispensing.

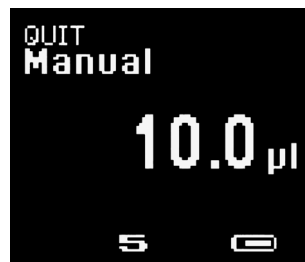

Manual pipetting

4. When the entire volume is dispensed, press the operating button to empty the tip or press the left Softkey for **no** to continue with aspiration.
5. Eject the tip by pressing the electronic tip ejector button.

Advanced Functions

Repeated Blow-out, available with Picus® Nxt, can be used in conjunction with Manual Pipetting mode for liquids where normal dispensing does not completely empty the tip.

For more information on using advanced functions [see section 3.2.10](#).

3.2.5. Diluting

In Dilution mode liquids separated by an air gap are aspirated and then dispensed simultaneously. Diluting can be used to dilute samples and reagents. The diluent is aspirated first followed by an air gap, then the sample or reagent to avoid contamination.

To select Diluting mode:

1. Select **menu** by pressing the left Softkey.
2. Use the adjustment wheel to select Diluting and confirm by pressing the operating button or the right Softkey for **OK**.

To edit the volume and speed settings:

1. Press the middle Softkey for **edit** or turn the adjustment wheel all the way to the right or left. The first setting to be edited is now highlighted.
 2. Turn the adjustment wheel to set the desired value.
 3. Confirm the setting by pressing
 - a. the operating button or the right Softkey for **OK**, which will exit the editing mode.
- Or
- b. the middle Softkey for **next**, to move on to edit the next highlighted setting.
4. Repeat steps 2 and 3 for all settings you wish to edit.
 5. To exit the editing mode without saving changes, press the left Softkey for **back**.

To use the pipette with the selected program:

1. Press the operating button to aspirate the diluent.
2. Press the operating button again to aspirate the air gap.
3. Press the operating button a third time to aspirate the sample.
4. Dispense the entire volume by pressing the operating button.
5. Empty the tip by pressing the operating button again.
6. Eject the tip by pressing the electronic tip ejector button.

Advanced Functions

Repeated Blow-out (Picus® Nxt only) and Mixing can be used in conjunction with Diluting.

- Mixing mixes liquids manually or automatically. The mixing volume can be adjusted according to the pipette's maximum volume.
- Repeated Blow-out helps to remove residual liquid from the tip, for liquids where normal dispensing does not empty it sufficiently.

For more information on using advanced functions [see section 3.2.10](#).

3.2.6. Sequential Dispensing

Sequential Dispensing repeatedly dispenses selected volumes in any desired order. This is a useful mode for diluting series and making calibration curves.

To select Sequential Dispensing mode:

1. Select **menu** by pressing the left Softkey.
2. Use the adjustment wheel to select Seq. Disp. and confirm by pressing the operating button or the right Softkey for **OK**. The latest settings used will then be displayed.

To edit the settings for speed, number of aliquots, and aliquot volumes:

1. Press the middle Softkey for **edit** or turn the adjustment wheel all the way to the right or left. The first setting to be edited is now highlighted.
2. Turn the adjustment wheel to set the desired value.
3. Confirm the setting by pressing
 - a. the operating button or the right Softkey for **OK**, which will exit the editing mode.

Or

 - b. the middle Softkey for **next**, to move on to edit the next highlighted setting.
4. Repeat steps 2 and 3 for all settings you wish to edit.
5. To exit the editing mode without saving changes, press the left Softkey for **back**.

To use the pipette with the selected program:

1. Press the operating button to aspirate the selected volume.
2. Press the operating button again for pre-out to make sure that the first aliquot will be of the correct volume.
3. Dispense the set aliquots by pressing the operating button each time.
4. After the last aliquot has been dispensed, press the operating button to empty the tip or press **no** to start aspirating without emptying the remaining liquid.
5. Eject the tip by pressing the electronic tip ejector button.

Advanced Functions

Repeated Blow-out (Picus® Nxt only) and Excess Adjustment can be used in conjunction with Sequential Dispensing.

- Excess Adjustment can be used to set the excess volume.
- Repeated Blow-out helps to remove residual liquid from the tip, for liquids where normal dispensing does not empty it sufficiently.

For more information on using advanced functions [see section 3.2.10.](#)

3.2.7. Multi-Aspirating

Multi-Aspiration aspirates a selected volume a set number of times. Multi-Aspirating is useful for sample pooling and microplate washing. Select the volume and the number of aspirations, aspirate until the series is completed, then discard the full aspirated volume in a single step.

To select Multi-Aspiration mode:

1. Select **menu** by pressing the left Softkey.
2. Use the adjustment wheel to select Multi-Aspiration and confirm by pressing the operating button or the right Softkey for **OK**. The latest settings used will then be displayed.

To edit the settings for speed, volume, and number of aspirations:

1. Press the middle Softkey for **edit** or turn the adjustment wheel all the way to the right or left. The first setting to be edited is now highlighted.
2. Turn the adjustment wheel to set the desired value.
3. Confirm the setting by pressing
 - a. the operating button or the right Softkey for **OK**, which will exit the editing mode.

Or

 - b. the middle Softkey for **next**, to move on to edit the next highlighted setting.
4. Repeat steps 2 and 3 for all settings you wish to edit.
5. To exit the editing mode without saving changes, press the left Softkey for **back**.

To use the pipette with the selected program:

1. Press the operating button repeatedly until all the set volumes are aspirated.
2. To dispense the liquid and empty the tip, press the operating button again.
3. Eject the tip by pressing the electronic tip ejector button.

Advanced Functions

Repeated Blow-out, available with Picus® Nxt, can be used in conjunction with Multi-Aspiration mode, for liquids where normal dispensing does not completely empty the tip.

For more information on using advanced functions [see section 3.2.10](#).

3.2.8. Titration

In Titration mode, the full volume is aspirated and then dispensing speed is manually controlled. The display shows the dispensed volume in real time during dispensing. Titration is used to determine the unknown concentration of an identified analyte.

To select Titration mode:

1. Select **menu** by pressing the left Softkey.
2. Use the adjustment wheel to select Titration and confirm by pressing the operating button or the right Softkey for **OK**. The latest settings used will then be displayed.



Titration mode

To edit the settings for speed, volume, and volume for Fast Dispensing (if enabled):

1. Press the middle Softkey for **edit** or turn the adjustment wheel all the way to the right or left. The first setting to be edited is now highlighted.
2. Turn the adjustment wheel to set the desired value.
3. Confirm the setting by pressing
 - a. the operating button or the right Softkey for **OK**, which will exit the editing mode.

Or

 - b. the middle Softkey for **next**, to move on to edit the next highlighted setting.
4. Repeat steps 2 and 3 for all settings you wish to edit.
5. To exit the editing mode without saving changes, press the left Softkey for **back**.

To use the pipette with the selected program:

1. Press the operating button to aspirate the set volume.
2. Press the operating button again and hold it down, or turn the adjustment wheel to the left to dispense the liquid. The dispensing

speed can be adjusted by how far the adjustment wheel is turned. To pause dispensing, briefly release the operating button or adjustment wheel.

3. To finish titrating, empty the tip by pressing the operating button twice.
4. When the titration cycle is completed, eject the tip by pressing the electronic tip ejector button.

Advanced Functions

Fast Dispensing can be used with the Titration mode. Fast Dispensing dispenses the first volume automatically, then subsequent volumes are dispensed manually.

For more information on using advanced functions [see section 3.2.10](#).

3.2.9. Protocols (Only in Picus® Nxt)

User-definable protocols speed up routine pipetting sequences. A maximum of ten pipetting and advanced function combinations can be used within a protocol. For example, pipetting with mixing counts as one combination. For operating buttons, [see 1.2. Product Overview](#).

To set up or edit a pipetting protocol:

1. Select **menu** by pressing the left Softkey.
2. Use the adjustment wheel to select Protocols and confirm by pressing the operating button or the Softkey for **OK**.
3. Use the adjustment wheel to select the desired protocol to set up or edit (P1-P3).
4. Press the middle Softkey for **edit**.
 - a. If the protocol has not yet been set up, you are first asked to enter a protocol name.
 - b. If the protocol already exists either:
 - i. Continue editing by pressing the Softkey for **edit**. Then go to step 6. When editing an existing protocol, it is not possible to edit the protocol name.

Or

 - ii. Clear the existing protocol by pressing the operating button or the Softkey for **OK**.
5. Edit the name of the protocol by pressing the Softkey for **edit**, or accept the name with the Softkey for **OK**.
 - a. When entering editing mode, the first character becomes highlighted and can be edited.
 - b. Capital letters are used by default. Use the middle Softkey to change the character type: ABC for capital letters, abc for lower case letters, 123 for numbers and #@! for other characters.
 - c. Turn the adjustment wheel to select your chosen character and confirm by pressing the operating button or the right Softkey for **OK**.
 - d. The next character to be edited is then highlighted. Repeat steps b and c until you have entered the name.
 - e. Press the operating button or the softkey for **OK** to accept the changes and exit the editing mode.
6. To add a step into a protocol:
 - a. Select Add step with the adjustment wheel and confirm with the operating button or Softkey for **OK**.
 - b. Select the desired pipetting mode with the adjustment wheel and confirm with the operating button or Softkey for **OK**.
 - i. You can select all main pipetting modes and the timer. The timer alerts the user when a defined period of time has elapsed.
 - ii. Each main pipetting mode, optionally combined with an

- advanced function and the timer, counts as one step in a protocol. A maximum of 10 steps can be included in a protocol.
- c. If needed, edit the mode settings. Move from one setting to the next (including additional modes) using the Softkey for **next**. Change settings using the adjustment wheel.
 - i. Settings order: basic mode settings (volume|number of dispenses|number of aspirations) – speed settings – advanced function settings.
 - ii. Advanced function settings can be changed using the adjustment wheel.
 - d. When in basic mode settings or speed settings, you can save the step using the operating button or the Softkey for **save**. When the Softkey for **save** is pressed, all settings in the step are saved.
 - e. Repeat the process from 6. a. to 6. d. until the protocol is ready.
7. To edit a step:
- a. Use the adjustment wheel to select the step you wish to edit and confirm by pressing the operating button or the Softkey for **edit**.
 - b. Follow the steps in 6. c. to 6. d. until the editing is completed.
8. To remove a step:
- a. Use the adjustment wheel to select Delete step and confirm with the operating button or the Softkey for **OK**. The pipette then lists the available steps.
 - b. Use the adjustment wheel to select the step to be deleted and confirm with the operating button or the Softkey for **OK**.
9. To save the protocol, press the Softkey for **save**.
Or
Press the Softkey for **back** to discard your changes and return to the Protocols menu. You will be asked to confirm if you want to discard your changes: press the appropriate Softkey for **yes** or **no**. If you select **no** you will be returned to the editing menu.



Titration has been programmed as the first step out of five.



The protocol has run through all its steps.

To activate a pipetting protocol:

1. Select **menu** by pressing the left Softkey.
2. Use the adjustment wheel to select Protocols and confirm by pressing the operating button or the Softkey for **OK**.
3. Use the adjustment wheel to select the desired protocol (P1-P3). Confirm by pressing the operating button or the Softkey for **OK**. The selected Protocol is now active. You can only activate a protocol that has been set up. To set up protocols please go to the start of [section 3.2.9](#).

To use a pipetting protocol:

1. When a pipetting protocol is activated, you automatically start on the first step.
2. Operate the pipette by pressing the operating button.
 - a. On the screen, next to the mode name, you can see the number of the current step and the total number of steps, e.g. 1|3 means that you are on the first step of three.
 - b. The pipette automatically takes you to the next step after each one is completed.
 - c. Alternatively you can navigate through the steps by using the Softkeys for **next** (next) and **prev** (previous).
3. When all the steps in the protocol are completed, the pipette will notify you with a sound (if enabled) and the text "Protocol completed!".
 - a. To restart the protocol, press the operating button or the Softkey for **next**.
 - b. To return to the last step, use the Softkey for **prev**.
 - c. To finish using the protocol, press the Softkey for **menu** and choose the next pipetting mode you wish to use.

Mode Settings and Advanced Functions

In Protocols, the mode settings and advanced functions are defined based on the modes selected inside the protocol. Please see main mode settings in sections 3.2.1 - 3.2.8 and advanced functions in section 3.2.10.

3.2.10. Advanced Functions

Advanced functions can be optionally used in conjunction with the main pipetting modes as shown on the table on [page 9](#) of this manual.

To activate or deactivate advanced functions, once you have already selected the main mode:

1. Press the right Softkey for **ADV**. All available advanced functions are listed and their current status (**on|off**) is displayed.
2. Scroll through the list of advanced functions using the Softkey for **next**.
3. Turn the selected highlighted advanced function on or off by turning the adjustment wheel.
4. Press the operating button or the Softkey for **OK** to accept the changes, or press the Softkey for **back** to discard.

Not all advanced functions can be used together. Tracker, Mixing, Auto Dispensing, and Counter cannot be active at the same time, but Repeated Blow-out (only in Picus® Nxt) can be used together with all other advanced functions. Excess Volume Adjustment doesn't affect other advanced functions.

Tracker

Tracker helps users to dispense into the correct microplate wells. It is only available on Picus® and Picus® Nxt pipettes and can be used with the following main modes: Pipetting, Reverse Pipetting, and Multi-Dispensing.

Once Tracker is activated, continue choosing the related settings.

Single-channel pipettes:

1. Select the microplate size (96 or 384 well plate) and the pipetting direction (rows or columns) by scrolling the adjustment wheel.
2. Press the operating button or the right Softkey for **OK** to activate Tracker.
3. The well to dispense into is shown on the display:
 - a. If pipetting in rows: A1 - A2 - A3... B1 - B2 - B3... C1 - C2 - C3... is displayed.
 - b. If pipetting in columns: 1A - 1B - 1C... 2A - 2B - 2C... 3A - 3B - 3C... is displayed.
4. The first dispensing location can be selected using the **edit** function of each main mode.

8-channel pipettes:

1. Select the microplate size (96 or 384 well plate). Only pipetting in columns is supported.
2. Press the operating button or the right Softkey for **OK** to activate Tracker.
3. The wells to dispense into are shown on the display:

For 96 well plates, columns 1, 2, 3... are shown.

For 384 well plates, columns are shown as follows:

 1. pipetting: A1 - C1 - E1...
 2. pipetting: B1 - D1 - F1...
 3. pipetting: A2 - C2 - E2...
 4. pipetting: B2 - D2 - F2...

etc.

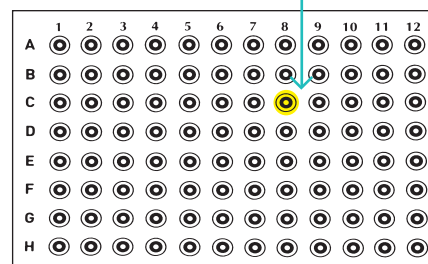
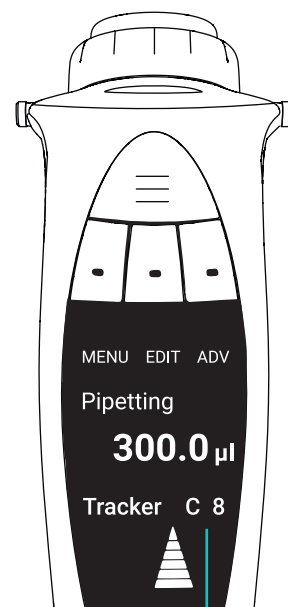

4. The first dispensing column can be selected using the **edit** function of each main mode.

12-channel pipettes:

1. Select the microplate size (96 or 384 well plate). Only pipetting in rows is supported.
2. Press the operating button or the right Softkey for **OK** to activate Tracker.
3. The wells to dispense into are shown on the display:
For 96 well plates, rows are shown as A, B, C...
For 384 well plates, rows are shown as follows:
 1. pipetting: A1 – A3 – A5...
 2. pipetting: A2 – A4 – A6...
 3. pipetting: B1 – B3 – B5...
 4. pipetting: B2 – B4 – B6...etc.
4. The first dispensing column can be selected using the **edit** function of the main mode.

Counter

Counter counts the number of pipetting cycles up to 384 and can be used in conjunction with Pipetting and Reverse Pipetting modes. You can start counting from any number up to 384. The starting number can be set with the adjustment wheel directly after the advanced function has been activated, or using the **edit** function in the main mode.

Mixing

With the Mixing mode the pipette mixes the liquids either manually when the operating button is held down or automatically a set number of times. The Mixing mode can be used in conjunction with Pipetting and Diluting modes. The volume for mixing can be selected freely up to the maximum volume of the pipette.

To edit the volume settings and select manual or automatic:

1. Select Mixing mode. The display shows the volume used for mixing (80% of the volume to be dispensed).
2. Turn the adjustment wheel to set the desired volume for mixing.
3. Confirm the setting by pressing either:
 - a. the operating button or the right Softkey for **OK**. This also exits the editing mode.

Or

 - b. the middle Softkey for **next**, to move on to select manual or automatic mixing and the number of mixing cycles.
4. If you chose 3.b, either turn the adjustment wheel to select Manual or choose the number of automatic dispensings.
5. Confirm the setting by pressing the operating button or the right Softkey for **OK**, which will also exit the editing mode.

To activate|deactivate mixing:

1. Start your chosen main mode and when the display tells you to “Start mixing”, either:
 - a. press and hold down the operating button for the duration of manual mixing.

Or

 - b. press the operating button once to activate the automatic dispensing cycles.

Or

 - c. press the left Softkey for **no** to exit Mixing.
2. You may pause mixing by pressing the operating button during the mixing cycle. By pressing it again, mixing continues.
3. You may also exit mixing during the mixing cycle by pressing the left Softkey for **quit**.
4. Continue by emptying the tip.

Excess Adjustment

Excess Adjustment can be used to set the excess volume in Reverse Pipetting, Multi-Dispensing, and Sequential Dispensing modes, where excess volume is being used. The excess volume varies according to the volume range of the pipette.

To set the excess volume:

1. Turn the adjustment wheel to select the desired volume after the advanced function has been activated. You may also press the middle Softkey for **default** to choose the default excess volume.
2. Confirm the selection by pressing the operating button or the right Softkey for **OK**.

Automated Dispensing

Automated Dispensing dispenses aliquots automatically, in timed intervals, in Multi-Dispensing mode. The user does not need to press the operating button each time liquid is dispensed. The dispensing interval can be set from 0,1 to 9,9 seconds.

To set the interval:

1. Turn the adjustment wheel to set the interval immediately after the advanced function has been activated.
2. Confirm by pressing the operating button or the right Softkey for **OK**.

Fast Dispensing

Fast Dispensing can only be used in Titration mode. In Fast Dispensing, the first selected portion of the total volume is dispensed automatically, and the remaining volume is dispensed manually.

To set the volume for Fast Dispensing:

1. Turn the adjustment wheel to set the desired volume immediately after the advanced function has been activated.
2. Confirm by pressing the operating button or the right Softkey for **OK**.

Repeated Blow-out (only in Picus® Nxt)

Repeated Blow-out allows the user to activate and repeat the blowout of remaining liquid droplets, for dispensing liquids that would normally leave a residue in the tip. Repeated Blow-out is available with Pipetting, Manual Pipetting, Diluting, and Multi-Aspiration modes.

To activate|deactivate Blow-out:

1. Start your chosen main mode.
2. Once the pipetting cycle has ended, you may repeat the blowout by pressing the operating button as many times as necessary.
3. To exit Blow-out, turn the adjustment wheel or eject the tip by pressing the tip ejector button.

3.3. Saving Pipetting Programs to Memory

All Picus® and Picus® Nxt models allow 10 programs to be saved in the pipette memory. In the Picus® Nxt, sequences of pipetting modes can be stored as protocols (see section 3.2.9). For operating buttons, see 1.2. Product Overview.

To save a program:

1. Choose the pipetting mode and edit the settings (see previous section), then press the Hotkey to see available memory places.
2. Choose a memory place by turning the adjustment wheel.
3. Press the middle Softkey for **save**.
 - a. In Picus® Nxt models, if the password feature has been activated, only the administrator profile can save programs.



To exit Blow-out, turn the adjustment wheel or eject the tip by pressing the tip ejector button.



M10 indicates that the pipetting program shown has been saved in memory place 10.

4. Next the pipette asks for a name for the memory place. Activate the name editor by pressing the operating button.
5. With the middle Softkey you can switch between characters, numbers and symbols. Turn the adjustment wheel to change the characters and press the operating button or the right Softkey for **OK** to confirm the selection and to move on to the next character. If you want to cancel the character change, you can press the left Softkey for **back**.
6. Repeat the sequence for all characters. Confirm the last character with **OK** or the operating button, and the pipette will exit the editing mode.
7. If you want to clear any of the characters in the name, turn the adjustment wheel until the character is underlined and press the right Softkey for **clear**. Repeat this until the desired characters are cleared.
8. Save the program name by pressing the middle Softkey for **save** and the pipette will return to the list of memory places.
9. If you wish to exit without saving the latest change, press the left Softkey for **back** at any time.

To activate the program from a memory place:

1. Press the Hotkey to see the list of memory.
2. Choose a memory place by turning the adjustment wheel.
3. Press the operating button or the right Softkey for **OK** to activate the saved program.
4. The pipette is now ready to run the program. The memory place is displayed next to the main mode name.

3.4. Setup

The pipette settings can be changed through the Setup menu. The following sections explain the various settings and how to modify them.

In Picus® Nxt models, if password protection is enabled, some settings can only be modified using the administrator profile ([see section 3.4.10](#)).

3.4.1. Adjustment

The default length of the piston stroke in Picus® and Picus® Nxt pipettes is defined by the manufacturer. This factory setting should be used in normal circumstances: with aqueous liquids, at standard atmospheric pressure, and with the pipette, tip, and liquid at standard room temperature.

When these circumstances change, the accuracy of the dispensed volume may be affected. To maintain accuracy, the Adjustment function can be used to change the default settings to take into account environmental factors or the type of liquid being used.

Adjustment is needed to correct the dispensed volumes in the following cases:

- when pipetting liquids with characteristics that greatly differ from water (for example viscous or volatile liquids)
- when the temperature between the pipette, pipette tip, and liquid differs greatly
- when the ambient air pressure differs from that of standard atmospheric pressure

Note: When factory settings are replaced with adjusted settings, the pipette's stated performance specifications (random and systematic error) are no longer applicable. However, when the factory settings are reactivated, the performance specifications will once again apply.

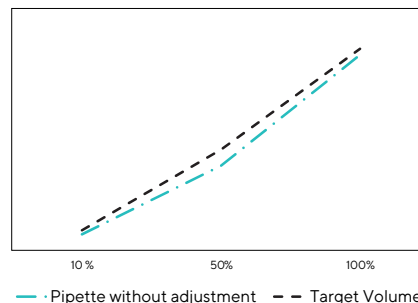

Theoretical comparison of target and actual values without adjustment

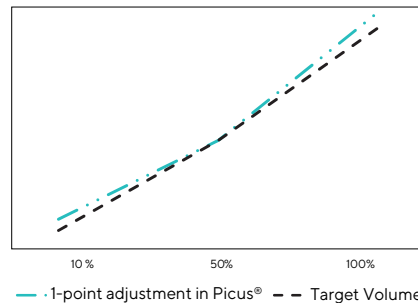

In this 1-point adjustment, 50% of maximum volume is being used to match actual and target results

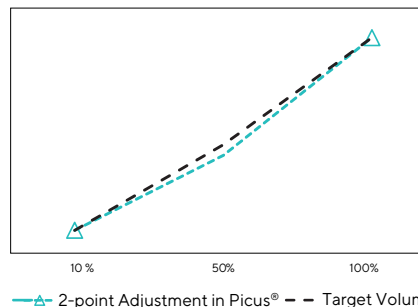

In 2-point adjustment, 10% and 100% of maximum volume are used to match actual and target results

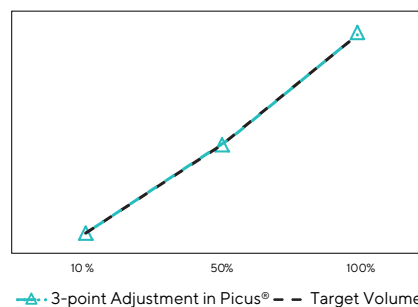

In 3-point adjustment, 10%, 50% and 100% of maximum volume are used to match actual and target results

The Adjustment function enables the user to adjust the pipette at one, two or three calibration points. The more measurement points selected, the greater accuracy is reached over the whole volume range of the pipette. Single-point adjustment is recommended when pipetting a constant volume within a range, and two or three point adjustment if performance over the whole range is required.

The adjustment options are:

- 1-point adjustment: adjustment at one point only, the user can choose the desired adjustment point|volume
- 2-point adjustment: adjustment at 10% and 100% of the nominal volume
- 3-point adjustment: adjustment at 10%, 50%, and 100% of the nominal volume

When adjusting for accuracy, the actual volumes delivered should be measured in Pipetting mode. Once the adjustment has been made it is applied to, all modes and an ADJ symbol is displayed on the screen.

It is possible to store three (3) adjustments in the adjustment memory: ADJ1, ADJ2, ADJ3. These can be activated at any time when specific uses require accuracy adjustments of the pipette.

To change the accuracy adjustment settings:

1. If password protection is enabled, log in using the administrator profile, (only in Picus® Nxt).
2. Select **menu** by pressing the left Softkey.
3. Use the adjustment wheel to select Setup and confirm by pressing the operating button or the Softkey for OK.
4. Highlight Adjustment by turning the adjustment wheel. Confirm the selection by pressing the operating button or the Softkey for OK.
5. Use the adjustment wheel to select ADJ1, ADJ2, or ADJ3. Press the middle Softkey to edit.
6. Use the adjustment wheel to select 1 Point, 2 Points, or 3 Points. Confirm your selection by pressing the operating button or the Softkey for OK.
7. For 1-point adjustment, first set the target volume for accuracy adjustment by turning the adjustment wheel and confirm by pressing the operating button or the Softkey for OK.
8. For 2 or 3-point adjustment, the target volumes are already set. Just confirm them by pressing the operating button or the Softkey for OK.
9. After setting or accepting the target volume, insert the actual volume delivered as per your measurement result by turning the adjustment wheel. Confirm by pressing the operating button or the Softkey for OK. If the difference between the target volume and the actual volume exceeds the limits for calibration, then the display will show "Calibration values out of range".
10. Repeat steps 7 and 8 for 2 or 3-point adjustment, until all volumes are set.
11. When the pipette asks if you want to save the adjustment data, confirm by pressing the operating button or the right Softkey for yes. If you do not wish to save the data, press the left Softkey for no.
12. Note that you may exit the editing mode at any time, without saving any changes by pressing the left Softkey for back.

To activate saved adjustment settings:

1. If password protection is enabled, log in using the administrator profile (only in Picus® Nxt).
2. Select **menu** by pressing the left Softkey.
3. Use the adjustment wheel to select Setup and confirm by pressing the operating button or the Softkey for OK.
4. Highlight Adjustment by turning the adjustment wheel. Confirm the



Choose the desired target volume



Enter the volume actually measured

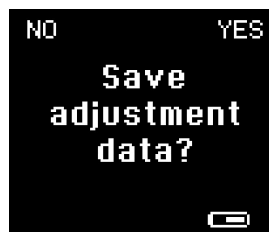

To save the adjustment, press either the Softkey for yes or the operating button.

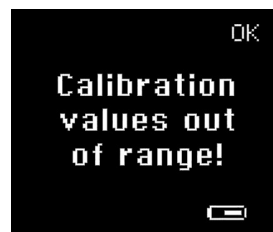

The difference between the target volume and the actual volume exceeds the limit that can be calibrated.



The pipette is set to use the adjustment values saved to ADJ1.

- selection by pressing the operating button or the Softkey for **OK**.
- Use the adjustment wheel to select ADJ1, ADJ2, or ADJ3. Confirm the selection by pressing the operating button or the Softkey for **OK**.
 - When the pipette asks if you wish to set the custom adjustment values, confirm by pressing either the operating button or the right Softkey for **OK**. If you do not wish to set the adjustment, press the left Softkey for **no**.
 - If you confirmed the setting, ADJ1, ADJ2, or ADJ3 is now displayed on the lower left corner of your screen, and the pipette has returned to the Setup menu. Press the left Softkey for **back** two times to get back to the main display.

To reset the pipette to factory adjustment settings:

- If password protection is enabled, log in using the administrator profile (only in Picus® Nxt).
- Select **menu** by pressing the left Softkey.
- Use the adjustment wheel to select Setup and confirm by pressing the operating button or the Softkey for **OK**.
- Highlight Adjustment function with the adjustment wheel and confirm by pressing the operating button or the Softkey for **OK**.
- Use the adjustment wheel to select Factory and confirm by pressing the operating button or the Softkey for **OK**.
- When the pipette asks if you want to set factory adjustment values, confirm by pressing the operating button or the right Softkey for **yes**. If you do not wish to reset to factory adjustment values, press the left Softkey for **no**.
- Once you have reset to factory adjustment settings you will no longer see the ADJ text in the lower left corner of the main display.

3.4.2. Sound

Sound effects when turning the adjustment wheel and for messages are on by default, but can be switched off.

To change the sound settings:

- Select **menu** by pressing the left Softkey.
- Use the adjustment wheel to select Setup and confirm by pressing the operating button or the Softkey for **OK**.
- Use the adjustment wheel again to select Sound. Confirm by pressing the operating button or the Softkey for **OK**.
- The Adj. Wheel setting is highlighted and listed as **on** or **off**.
 - If you wish to change the setting, turn the adjustment wheel and press the operating button or the right Softkey to confirm the change.

Or

 - Leave the setting as it is by pressing the operating button or the right Softkey to accept the setting.
- The Messages setting is then highlighted and listed as **on** or **off**. Repeat step 4.a or 4.b.
- Press the left Softkey for **back** to exit the editing mode at any time without saving changes.
- Once you are back in the Setup menu, press the left Softkey for **back** two times to return to the main display.

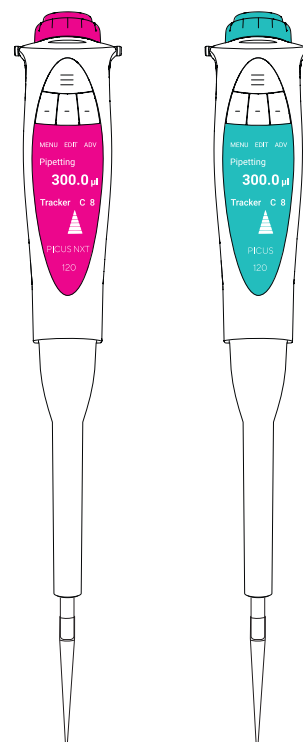

3.4.3. Backlight

The backlight colour of the display can be changed. By default it is white-gray while the pipette is in use and matches the volume colour code while charging. The operating button and matching tips are similarly colour coded to aid tip selection. If the backlight colour is changed by the user, the selected colour is applied both while the pipette is in use and while it is charging.

Colour code matching backlights

To change the display backlight colour:

1. Select **menu** by pressing the left Softkey.
 2. Use the adjustment wheel to select Setup and confirm by pressing the operating button or the Softkey for **OK**.
 3. Use the adjustment wheel again to select Backlight and confirm by pressing the operating button or the Softkey for **OK**.
 4. All colour options are listed. Choose a colour with the adjustment wheel.
 - a. Confirm your selection by pressing the operating button or the Softkey for **OK**.
- Or
- b. Press the left Softkey for **back** to exit the list without saving any changes.
5. Once you are back in the Setup menu, press the left Softkey for **back** two times to return to the main display.

3.4.4. User ID

The pipette can be named to help with identification. For example, users can add their name to their pipette so laboratory technicians know whose pipette is whose. When the pipette is turned on, the name is displayed on the screen.

To change the ID|name:

1. Select **menu** by pressing the left Softkey.
2. Use the adjustment wheel to select Setup and confirm by pressing the operating button or the Softkey for **OK**.
3. Use the adjustment wheel again to select User ID and confirm by pressing the operating button or the Softkey for **OK**.
4. The current name is displayed on the screen.
5. To edit the name press the Softkey for **edit**. The first character becomes highlighted and can be edited.
6. Capital letters are used by default. Use the middle Softkey to change the character type: ABC for capital letters, abc for lower case letters, 123 for numbers and #@! for other characters.
7. Turn the adjustment wheel to select your chosen character and confirm by pressing the right Softkey for **OK** or the operating button.
8. The next character to be edited is highlighted. Repeat steps 6 and 7 until you have finished your chosen ID, then press the middle Softkey to **save**. If you do not want to save your new ID, press the left Softkey for **back**.
9. Once you are back in the Setup menu, press the left Softkey for **back** two more times to return to the main display.

To delete characters:

1. Follow steps 1 to 4 above to see the current ID.
2. Turn the adjustment wheel to highlight the character to be deleted and press the middle Softkey for **edit**.
3. Press the middle Softkey four times until it shows **clear**. Press the operating button or the right Softkey for **OK** to move on to the next character.
4. Repeat step 2 for every character to be deleted.
5. Press the middle Softkey for **save** to return to the Setup menu, or continue editing the ID. Please note that not all characters can be deleted.
6. If you do not want to save your changes, press the left Softkey for **back**.
7. Once you are back in the Setup menu, press the left Softkey for **back** two more times to return to the main display.



Setting the user ID

3.4.5. GLP Info (only in Picus®)

The GLP (Good Laboratory Practice) Info function allows dates to be saved to show when the pipette was last serviced or calibrated and when the next service or calibration is due.

In Picus® Nxt pipettes, service, calibration, and check reminders can all be programmed. Please [see section 3.4.12](#).

To change the dates:

1. Select **menu** by pressing the left Softkey.
2. Use the adjustment wheel to select Setup and confirm by pressing the operating button or the Softkey for OK.
3. Use the adjustment wheel again to select GLP Info and confirm by pressing the operating button or the Softkey for OK.
4. The previously used dates are displayed on the screen. Turn the adjustment wheel to edit the date|month|year and confirm by pressing the operating button or the Softkey for OK. The next field then becomes editable.
5. When you have finished editing, confirm the last field with the operating button or the Softkey for OK and you will be returned to the Setup menu.
6. To exit without saving any changes, press the left Softkey for **back** at any time.
7. Once you are back in the Setup menu, press the left Softkey for **back** two more times to return to the main display.



Resetting the pipette to factory settings

3.4.6. Reset

The Reset function allows you to overwrite all personal settings including stored programs and revert to factory settings.

To reset pipette settings:

1. If password protection is enabled, log in using the administrator profile, (only in Picus® Nxt).
2. Select **menu** by pressing the left Softkey.
3. Use the adjustment wheel to select Setup and confirm by pressing the operating button or the Softkey for OK.
4. Use the adjustment wheel again to select Reset and confirm by pressing the operating button or the Softkey for OK.
5. The pipette will ask if you want to reset all settings.
 - a. If yes, press the right Softkey or the operating button. Follow the instructions on the screen and press the tip ejection button. The settings are now reset to factory defaults.
- Or
- b. To cancel the reset, press the left Softkey for **no**. The settings will not be reset and you will be returned to the Setup menu.
6. Once you are back in the Setup menu, press the left Softkey for **back** two times to return to the main display.

3.4.7. Information

Information displays the current software version of the pipette and the level of charge in the battery. This information cannot be edited.

To view Information:

1. Select **menu** by pressing the left Softkey.
2. Use the adjustment wheel to select Setup and confirm by pressing the operating button or the Softkey for OK.
3. Use the adjustment wheel again to select Information and confirm by pressing the operating button or the Softkey for OK.

4. The display shows the current software version and the battery charge level.
5. To exit, press the operating button or the right Softkey for OK and you'll be returned to the Setup menu.
6. Once you are back in the Setup menu, press the left Softkey for back two times to return to the main display.

3.4.8. Languages

The user interface language can be changed using the Language setting. The available languages are English, French, German, Chinese, and Russian (available from software version 1.07 onwards).

To change the language:

1. Select **menu** by pressing the left Softkey.
 2. Use the adjustment wheel to select Setup and confirm by pressing the operating button or the Softkey for OK.
 3. Use the adjustment wheel again to select Languages and confirm by pressing the operating button or the Softkey for OK.
 4. The list of available languages is shown on the display.
 - a. Use the adjustment wheel to select a language and confirm by pressing the operating button or the right Softkey for OK. Confirming will return you to the Setup menu.
- Or
- b. If you do not wish to change the language, press the left Softkey for **back** to return to the Setup menu.
5. Once you are back in the Setup menu, press the left Softkey for back two times to return to the main display.



French



German

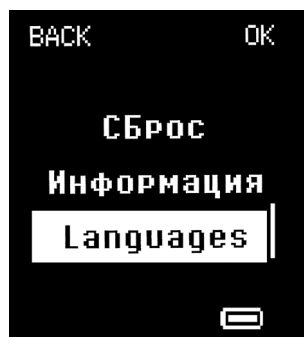

Russian



Chinese



Pipette locked for service

3.4.9. Pipette Lock (only in Picus® Nxt)

Pipette lock allows the pipette to be locked so that it cannot be used. When Pipette lock is enabled "Pipet locked. Service required!" is shown on the display and the pipette's functions are disabled. This can be used when something is wrong with the pipette or it has become contaminated, preventing it from being used until it is next serviced or cleaned.

Pipette lock can be activated from Setup by any user. The pipette can be unlocked by pressing the Softkey for unlock. If password protection is enabled, the administrator password is needed to unlock the pipette.

To activate Pipette lock:

1. Select **menu** by pressing the left Softkey.
2. Use the adjustment wheel to select Setup and confirm by pressing the operating button or the Softkey for OK.
3. Use the adjustment wheel again to select Pipette lock and confirm by pressing the operating button or the Softkey for OK.
4. The pipette shows "Lock pipette?"
 - a. To lock, press the operating button or the Softkey for yes.
 - b. To leave the pipette unlocked, press the Softkey for no.

To unlock the pipette:

1. The pipette shows "Pipet locked. Service required!"
2. To unlock press the Softkey for unlock.
 - a. If password protection is enabled, the pipette asks for a password. The administrator password is required to unlock the pipette.

3.4.10. Passwords (only in Picus® Nxt)

Picus® Nxt pipette has two-level password protection. The first level is administrator level, with unrestricted permissions, and the second is the user level, which is restricted. In password settings, password protection can be activated, deactivated, and both passwords set.

If password protection is enabled, only the administrator can access Adjustment, Passwords, Date & Time, and Reminders, save programs under the Hotkey feature, and edit and save protocols. The user profile can use all modes, and can access Sound, Backlight, User ID, Information, Languages, and Pipette lock. The user profile can use saved programs and protocols, but cannot edit or save them.

To log out if password protection is enabled, press the power button briefly. To log in, enter the administrator password or a user password.

To set the administrator or user password:

1. Select **menu** by pressing the left Softkey.
2. Use the adjustment wheel to select Setup and confirm by pressing the operating button or the Softkey for OK.
3. Use the adjustment wheel to select Passwords and confirm by pressing the operating button or the Softkey for OK.
4. Use the adjustment wheel to select Set Admin or Set User. Confirm by pressing the operating button or the Softkey for OK.
5. Enter a new password by selecting numbers with the adjustment wheel and confirming them by pressing the operating button or the Softkey for OK. Four numbers (0-9) are required.
6. Once you have confirmed the fourth digit, the new password is set, and the pipette display shows “New password set!”

Note: If password protection has already been enabled, log in using the administrator profile, to set and edit passwords.

To turn password protection on:

1. Select **menu** by pressing the left Softkey.
2. Use the adjustment wheel to select Setup and confirm by pressing the operating button or the Softkey for OK.
3. Use the adjustment wheel to select Passwords and confirm by pressing the operating button or the Softkey for OK.
4. Use the adjustment wheel to select Login. This also shows whether password protection is currently **on** or **off**.
5. Switch from **off** to **on** by pressing the operating button or the Softkey for OK.
6. The pipette will ask for a password. Either:
 - a. Enter the administrator password
 - Or
 - b. If no password has yet been set, enter the default administrator password 0000
7. The word **on** next to Login confirms that password protection is enabled.

To log in using an administrator or user profile:

1. The pipette will ask for a password.
2. Use the adjustment wheel to select the first number of the administrator or user password. Confirm by pressing the operating button or the Softkey for OK.
3. Repeat step 2 for the next three digits. Once the last number of the password is confirmed, the user is logged in.

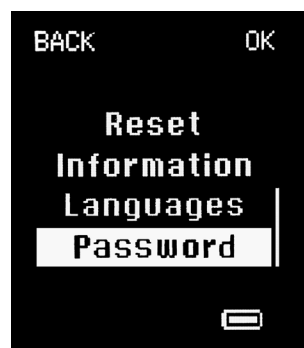

Password



Entering the password

To log out:

1. Password protection must be enabled and administrator|user passwords set (see above).
2. Press the power button briefly to log out. This cannot be done while using any of the modes.

To turn off password protection:

1. Log in using the administrator profile (only in Picus® Nxt).
2. Select **menu** by pressing the left Softkey.
3. Use the adjustment wheel to select Setup and confirm by pressing the operating button or the Softkey for OK.
4. Use the adjustment wheel to select Passwords and confirm by pressing the operating button or the Softkey for OK.
5. Use the adjustment wheel to select Login. On will be displayed next to Login if password protection is enabled.
6. Switch password protection to **off** by pressing the operating button or the Softkey for OK.

3.4.11. Date and Time (only in Picus® Nxt)

The Picus® Nxt pipette has a calendar and clock that are used for reminders and timers. The date and time are asked for during the initial setup of the pipette, but can also be modified later.

To change the date and time:

1. If password protection is enabled, log in using the administrator profile.
2. Select **menu** by pressing the left Softkey.
3. Use the adjustment wheel to select Setup and confirm by pressing the operating button or the Softkey for OK.
4. Use the adjustment wheel to select Date & time. Confirm by pressing the operating button or the Softkey for OK.
5. Use the adjustment wheel to change the highlighted digit. Confirm the change and move to the next digit by pressing the operating button or the Softkey for OK. To return to the previous digit, use the Softkey for **prev**.
6. Once the final digit has been selected, save the changes by pressing the operating button or the Softkey for **save**. To discard your changes at any point, press the Softkey for **back**.

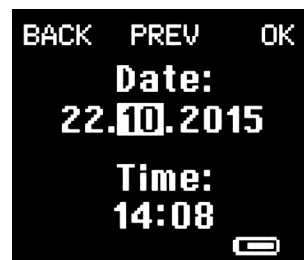

Setting the date and time

3.4.12. Reminders (only in Picus® Nxt)

Picus® Nxt has built in reminders for Maintenance, Calibration, and Pipette checking. The reminders help the user to remember important service dates. Having the pipettes maintained and calibrated at regular intervals is an important factor in ensuring the quality and accuracy of results.

Reminders can be set to time and/or cycle intervals. For example, a calibration reminder can be set for six months or 5,000 pipetting cycles, whichever comes first. When the criteria is reached, the pipette notifies the user with a message and sound.

With time-based reminders for maintenance and calibration, the pipette also alerts the user 14 days before the set date.

To set a reminder:

1. If password protection is enabled, log in using the administrator profile.
2. Select **menu** by pressing the left Softkey.



Information when the last calibration has been made

3. Use the adjustment wheel to select Setup and confirm by pressing the operating button or the Softkey for **OK**.
4. Use the adjustment wheel to select Reminders and confirm by pressing the operating button or the Softkey for **OK**.
5. Use the adjustment wheel to select the reminder type. Confirm the selection by pressing the operating button or the Softkey for **OK**.
6. Use the Softkeys for **next** and **prev** to move forward and backward in the menu.
 - a. **Last**: shows the last time that the pipette was maintained, calibrated, and/or checked. This date needs to be reset manually, by pressing the Softkey for **reset**.
 - b. **Months|Weeks**: shows the interval between maintenance and between calibration in months and between checks in weeks. This interval can be modified with the adjustment wheel. The options available are off and from 1 to 12. Confirm the change and move to the next setting by pressing the Softkey for **next**.
 - c. **Cycles**: shows the number of pipetting cycles between maintenance, calibration, and/or checks. The number options are off and from 100 to 20,000. Use the adjustment wheel to change the number of cycles. Confirm the change and move to the next setting by pressing the Softkey for **next**.
 - d. **Snooze dd**: shows the number of days a reminder can be snoozed. If enabled, users can snooze reminders for the set number of days. The options available are off and from 1 to 30.
 - e. Press the Softkey for **save**. This saves all reminder settings.

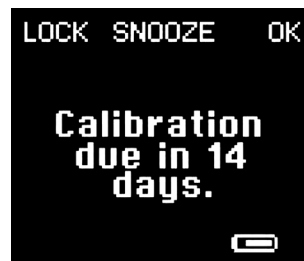

Calibration pre-reminder

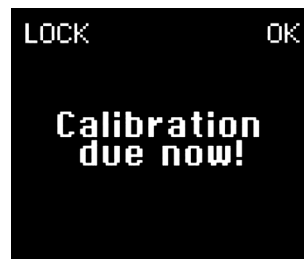

Calibration reminder

Note: If both time intervals and number of cycles are set, the reminder will alert you when the first one is reached.

To turn off a reminder:

1. If password protection is enabled, log in using the administrator profile.
2. Select **menu** by pressing the left Softkey.
3. Use the adjustment wheel to select Setup and confirm by pressing the operating button or the Softkey for **OK**.
4. Use the adjustment wheel to select Reminders and confirm by pressing the operating button or the Softkey for **OK**.
5. Use the adjustment wheel to select the reminder to turn off. Confirm by pressing the operating button or the Softkey for **OK**.
6. Use the Softkeys for **next** and **prev** to move in the menu.
7. Use the adjustment wheel to set the date and cycle intervals to **off**.
8. Confirm changes with the Softkey for **save**.

When a Reminder Occurs

Reminders are shown as a text alert on the screen accompanied by a sound, if it has been enabled in the setup.

Options for reacting to the reminder:

1. **Lock**: Lock the pipette from being used. The user can lock the pipette by pressing the Softkey for **lock**. If password protection is enabled, the administrator password is required to unlock the pipette (see section 3.4.9).
2. **Snooze**: If the snooze feature is **on** in Reminders, users can snooze reminders by pressing the Softkey for **snooze**. This snoozes the reminder for the number of days specified in Reminders.
3. **OK**: Users can dismiss reminders by pressing the Softkey for **OK**. The reminder will pop up again after the next pipetting cycle. This allows users to complete a pipetting series before locking the pipette for maintenance, calibration, or checking.

To reset a reminder:

1. If password protection is enabled, log in using the administrator profile.

2. Select **menu** by pressing the left Softkey.
3. Use the adjustment wheel to select Setup and confirm by pressing the operating button or the Softkey for **OK**.
4. Use the adjustment wheel to select Reminders and confirm by pressing the operating button or the Softkey for **OK**.
5. Use the adjustment wheel to select the reminder to reset (maintenance, calibration, or check). Confirm by pressing the operating button or the Softkey for **OK**.
6. Use the Softkeys for **next** and **prev** to highlight the last date.
7. Press the Softkey for **reset** to reset both date and cycle intervals.
8. Confirm by pressing the operating button or the Softkey for **yes**, or cancel by pressing the Softkey for **no**.

3.4.13. Tip ejection

With the Tip ejection double-click setting, you can select whether the tip ejector needs to be pressed once or twice to eject the tip.

To select how the tip is ejected:

1. Select **menu** by pressing the left Softkey.
2. Use the adjustment wheel to select Setup, and confirm by pressing the operating button or the right Softkey for **OK**.
3. Use the adjustment wheel to select Tip ejection, and confirm by pressing the operating button or the right Softkey for **OK**. The latest setting used is then displayed.
4. Turn the adjustment wheel to set Double-click **on** or **off**.
5. Confirm the setting by pressing the operating button or the right Softkey for **OK**.

To use the pipette with the selected setting:

- If you set the double-click setting **on**, eject the tip by pressing the electronic tip ejector button twice.
- If you set the double-click setting **off**, eject the tip by pressing the electronic tip ejector button once.

4. Maintaining the Pipette

As with any precision instrument, pipettes have many mechanical and electronic parts that are subject to wear and tear. By taking care of your pipette and carrying out regular maintenance and adjustment, its functionality and performance can be ensured. Cleaning is always recommended after possible contamination or after dispensing corrosive or aggressive chemicals.

To avoid pipette and sample contamination and to extend the pipette's lifetime, Sartorius Safe-Cone Filters (available for pipettes >10 µl) or Sartorius Safetyspace® Filter Tips should be used.

Sartorius provides service, maintenance, and calibration services through its global network of service centres. Please contact your nearest service centre for assistance.

The warranty will be voided if the pipette is disassembled or assembled by an unauthorized person.

Note: Make sure the pipette has been decontaminated before you send it for repair or calibration. Be sure to note any hazardous material that the pipette has been exposed to. For more information [see 4.2, Sterilizing the pipette](#).

Note: Turn off the pipette prior to cleaning.

Note: It is recommended that gloves are always worn when cleaning the pipette.

4.1. Cleaning the Outer Surface of the Pipette (daily)

To clean and decontaminate the outer surface of the pipette, use a disinfectant liquid or mild detergent, for example 70% ethanol, and a soft, lint-free cloth. Gently clean the surface of the pipette with the moistened cloth and wipe it dry. Pay special attention to the tip cone.

Always check the chemical compatibility between the pipette materials and the disinfectant or decontaminant liquid.

Change the Safe-Cone Filter regularly with the tweezers provided with the pipette.

Do not let liquids enter the inner parts of the pipette.

4.1.1. Cleaning the Lower Part of a Single Channel Pipette (every three months)

If the pipette is in daily use, it is recommended to clean, decontaminate, and grease it every three months.

Note: We recommend sending multichannel pipettes to your local Sartorius service center for cleaning and greasing.

Parts and materials:

1. Tip ejector collar (polyvinylidene fluoride (PVDF)) in 10 µl, 120 µl, 300 µl and 1,000 µl pipettes, (polypropylene (PP)) in 5,000 µl and 10,000 µl pipettes.
2. Locking ring (polyetherimide (PEI) in 10,000 µl pipettes, polyamide (PA) in all other pipettes)
3. Tip cone (polyvinylidene fluoride (PVDF) in 10 µl pipettes, polyetherimide (PEI) in 200 and 300 µl pipettes, polyphenylenesulphide (PPS) in 1,000 µl, 5,000 µl, and 10,000 µl pipettes)
4. Piston (stainless steel (SS) in 10 µl pipettes, polyphenylenesulphide (PPS) in 120 µl, 5,000 µl and 10,000 µl pipettes, polyetherimide (PEI) in 300 µl and 1,000 µl pipettes)
5. Piston seal (fluoroelastomer (FKM) in 10 µl and 10,000 µl pipettes, ethylene propylene diene monomer (EPDM) in 120 µl, 300 µl, 1,000 µl and 5,000 µl pipettes)
6. Spring (stainless steel (SS) in 10 µl, 120 µl, 300 µl and 1,000 µl pipettes)

To clean and decontaminate the lower parts of a single-channel pipette, follow the steps below:

To disassemble and clean the pipette:

1. Remove the tip cone filter using the tweezers provided.
 2. Unscrew the tip ejector collar (1) counterclockwise and remove it.
 3. Depending on the pipette volume:
 - a. With all pipettes other than the 5,000 µl or 10,000 µl models, unscrew the locking ring (2) counter clockwise and carefully remove it together with the tip cone (3).
- Or
- b. With a 5,000 µl pipette, hold the locking ring (2) firmly with your fingers and turn the tip cone cylinder counter clockwise with the other hand (see image below). Do not turn the locking ring as you turn the tip cone (3) as this will break the pipette.

10 and 120 µl pipettes

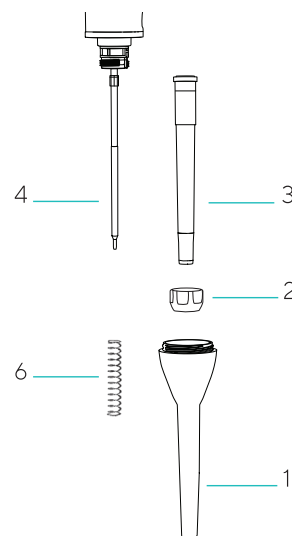

300 and 1,000 µl pipettes

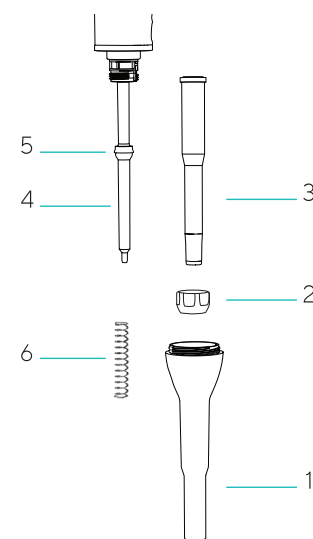

5,000 µl and 10,000 µl pipettes

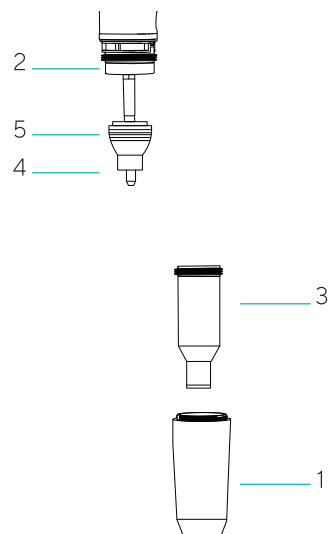

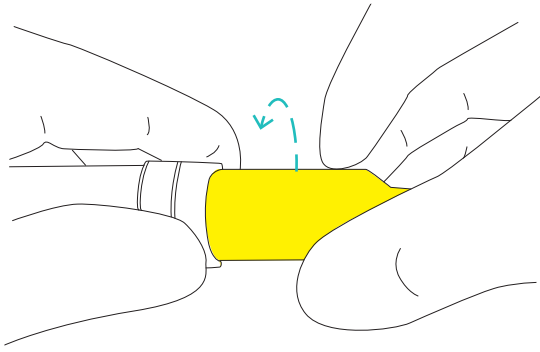

Or

- c. With a 10,000 μl pipette hold the tip cone cylinder firmly and turn the locking ring (2) clockwise with your fingers (see image below). Do not turn the tip cone (3) as this will break the pipette.

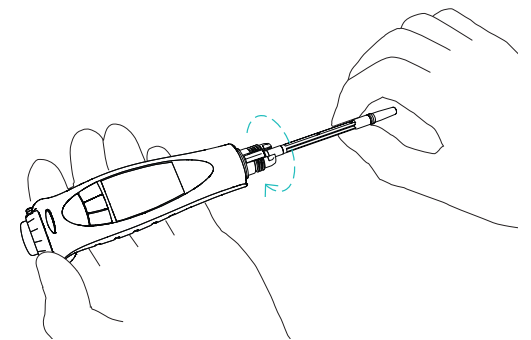
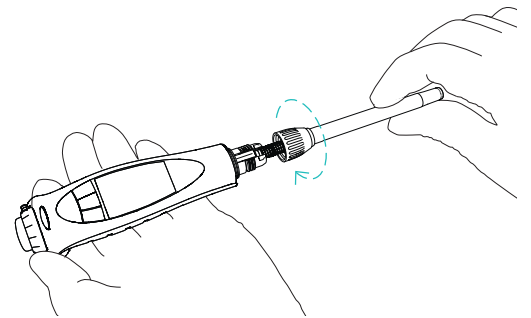
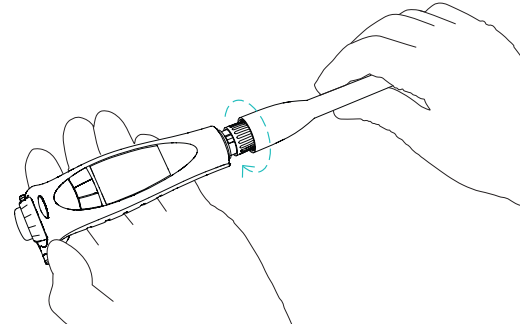
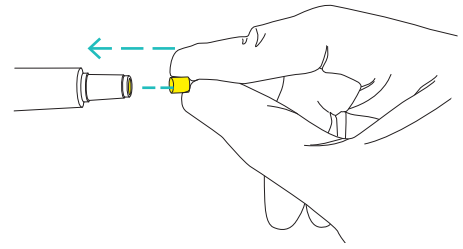
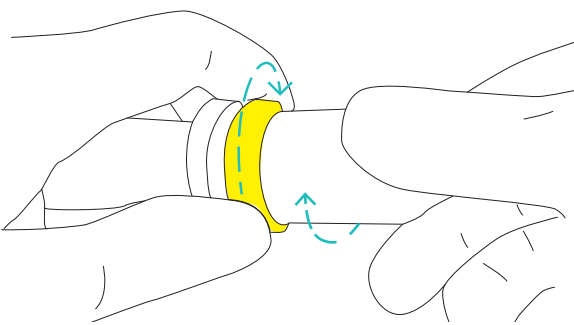

4. Clean the tip ejector collar (1), the tip cone holder, the tip cone cylinder, and the piston (4) with a disinfectant liquid or mild detergent and a soft, lint-free cloth.
 5. Clean the interior of the tip ejector collar (1) and the tip cone cylinder with a cotton swab. Be careful with 10 μl and 120 μl pipettes to ensure the seal inside the tip cone is not damaged.
 6. Rinse the parts with distilled water if necessary and allow them to dry.
 7. Depending on the pipette volume:
 - a. With a 10 μl or 120 μl pipette, apply a thin layer of grease on the piston (4).
- Or
- b. With a 300 or 1,000 μl pipette, apply a thin layer of grease around the seal (5).
- Or
- c. With a 5,000 μl or 10,000 μl pipette, apply a thin layer of grease on the interior of the tip cone cylinder and around the seal (5).

Note: Avoid excess grease. Only use the grease provided with the pipette.

Note: Before reassembly, check that there is no lint or particles on the surface of the piston.

Note: Always check the performance of the pipette after cleaning or maintenance.

To reassemble the pipette:

1. Depending on the pipette volume:
 - a. With a 10, 120, 300, or 1,000 μl pipette, carefully place the tip cone (3) on the piston (4) and attach it by screwing the tip cone holder clockwise.
- Or
- b. With a 5,000 μl pipette, carefully place the tip cone cylinder

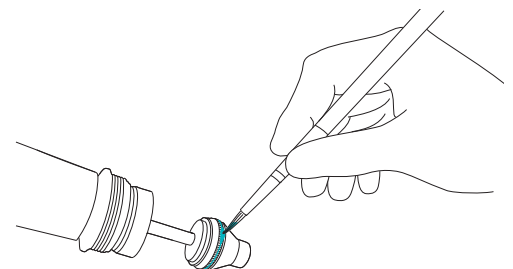
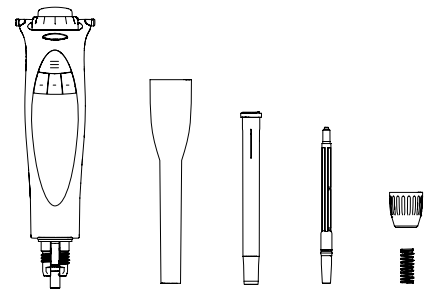

on the piston (4) and screw clockwise. Make sure the tip cone cylinder is properly tightened. Avoid over-tightening.

Or

- c. With a 10,000 µl pipette, carefully place the tip cone cylinder on the piston (4) and screw the locking ring (2) counterclockwise. Make sure the tip cone cylinder is properly tightened. Avoid over-tightening.
2. Attach the tip ejector collar (1) by screwing it clockwise.
3. Insert a new tip cone filter.
4. Press the operating button several times to ensure that the grease has spread evenly.
5. Check the performance of the pipette.

Note: Always check the performance of the pipette after in-house service or maintenance.

4.1.2. Multichannel Pipettes

Cleaning the outer surface (all models):

Clean any visible dirt with cleaning solution and a lint-free cloth.

Wipe dry.

Cleaning and maintaining the lower parts of all models:

Opening the lower part of a multichannel pipette should only be done by an authorized Sartorius service provider. Please contact your nearest Sartorius service provider or distributor.

4.2. Sterilizing

The lower parts of Sartorius electronic pipettes can be sterilized by autoclaving, with UV or by using disinfectant or decontaminant liquids such as 70% ethanol, 60% isopropanol, mild detergent, or similar. Always make sure the materials of the pipette and the disinfectant or decontaminant liquid are chemically compatible.

Always follow the autoclaving instructions below.

4.2.1. Autoclaving

The lower parts of Sartorius electronic pipettes are autoclavable, excluding the 1,200 µl multichannel model. Please see the autoclaving symbol printed on the lower part of your pipette to ensure the section is autoclavable.

Autoclaving Instructions:

1. Remove the Safe-Cone Filter if attached.
 2. Disassemble the lower part:
 - a. with single channel pipettes, unscrew the tip ejector collar, tip cone and piston by turning them counter-clockwise. Place these parts in a sterilisation bag
- Or
- b. with multichannel pipettes, unscrew the connecting collar counter-clockwise to remove the tip cone housing, and place it in a sterilisation bag.
3. Sterilize the parts at 121°C and 1 bar overpressure for 20 minutes.
 4. Let the parts cool and dry before reassembling.

4.2.2. UV Sterilization

Sartorius electronic pipettes are made of UV-resistant materials. Sartorius pipettes tolerate temporary exposure to UV radiation. Take note that prolonged or frequent exposure to UV radiation may cause yellowing and brittling of the pipette.

4.3. Performance Testing

It is recommended that the performance of Sartorius pipettes is checked regularly (e.g. every three months) and always after in-house maintenance. A regular testing routine should be established by users, taking into consideration the accuracy requirements of the application, frequency of use, number of operators using the pipette, nature of the liquid dispensed, and the acceptable maximum permissible errors (ISO 8655-1).

Performance tests should take place in a draught-free room at 15–30°C, kept constant within $\pm 0.5^\circ\text{C}$ and with relative humidity above 50%. The pipette, tips, and test water should have stood in the test room for long enough to reach equilibrium with the room conditions (at least two hours). Use distilled or de-ionised water (ISO 3696, grade 3) and an analytical balance that conforms to ISO 8655-6.

Weighing

1. Adjust the desired test volume (V_S).
2. Carefully fit the tip onto the tip-cone.
3. Fill the tip with test water and empty it five times to achieve humidity equilibrium in the dead air volume.
4. Replace the tip. Pre-wet the tip by filling it once with the test water and emptying.
5. Aspirate the test water, immersing the tip only 2-3 mm below the surface of the water. Keep the pipette vertical.
6. Withdraw the pipette vertically and touch the tip against the side wall of the test water container.
7. Pipette the water into the weighing vessel, touching the tip against the inside wall of the vessel just above the liquid surface at an angle of 30° to 45° . Withdraw the pipette by drawing the tip 8-10 mm along the inner wall of the weighing vessel.
8. Read the weight in mgs (m_i).
9. Repeat the test cycle until 10 measurements have been recorded.
10. Convert the recorded masses (m_i) to volumes (v_i) by multiplying the mass with the correction factor Z (Z-values in the table below): $V_i = m_i \cdot Z$
11. Calculate the mean volume (V) delivered: $V = (V_i)/10$
12. For conformity evaluation calculate the systematic error e_s of the measurement:
 in μl : $e_s = V - V_S$ $V_S =$ selected test volume
 or in %: $e_s = 100 (V - V_S)/V_S$
13. And calculate the random error of the measurement as standard deviation:

$$s = \sqrt{\frac{\sum(V_i - \bar{V})^2}{n - 1}} \quad n = \text{number of measurement (10)}$$

or as coefficient of variation $CV = 100s/V$

14. Compare the systematic error (inaccuracy) and random error (imprecision) to the performance specification values of your own laboratory.

Table 1: Z-values ($\mu\text{l}/\text{mg}$)

Temp. ($^\circ\text{C}$)	Air Pressure (kPa)			
	95	100	101.3	105
20.0	1.0028	1.0028	1.0029	1.0029
20.5	1.0029	1.0029	1.0030	1.0030
21.0	1.0030	1.0031	1.0031	1.0031
21.5	1.0031	1.0032	1.0032	1.0032
22.0	1.0032	1.0033	1.0033	1.0033
22.5	1.0033	1.0034	1.0034	1.0034
23.0	1.0034	1.0035	1.0035	1.0036
23.5	1.0036	1.0036	1.0036	1.0037

Note: Systematic error is the difference between the dispensed volume and the target volume. Random error is the scatter of the dispensed volumes around the mean of the dispensed volume (ISO 8655-1).

Note: Sartorius specifications are achieved in strictly controlled conditions (ISO 8655-1). Users should establish acceptable maximum permissible errors based on the field of use and the accuracy requirements placed on the pipette (ISO 8655-1).

4.4. Replacing the Battery

We recommend that the Picus®|Picus® Nxt battery is replaced only by an authorized Sartorius service provider. Please contact your nearest Sartorius representative.

4.5. Replacement Parts

Sartorius offers a full range of replacement parts. Always contact Sartorius or an authorized representative for original spare parts for your Sartorius pipette.

4.6. Storage

We recommend storing Picus®|Picus® Nxt electronic pipettes on the charging stand when not in use. During storage periods of several months or more, we recommend disconnecting the charging stand from the mains power outlet, and turning the pipette off by pressing the power button on the top of the pipette.

5. Warranty

Sartorius products are meant to be used as described in this user manual.

Picus®|Picus® Nxt electronic pipettes are covered by a two-year warranty against defects in workmanship and materials. The battery is not covered by our warranty.

ANY WARRANTY WILL, HOWEVER, BE DEEMED AS VOID IF THE FAULT IS FOUND TO HAVE BEEN CAUSED BY MISTREATMENT, MISUSE, UNAUTHORIZED MAINTENANCE OR SERVICE, NEGLIGENCE OF REGULAR MAINTENANCE AND SERVICE, ACCIDENTAL DAMAGE, INCORRECT STORAGE, OR USE OF THE PRODUCT FOR OPERATIONS OUTSIDE THEIR SPECIFIED LIMITATIONS, OUTSIDE THEIR SPECIFICATIONS, CONTRARY TO THE INSTRUCTIONS GIVEN IN THIS MANUAL, OR WITH TIPS OTHER THAN THE MANUFACTURER'S ORIGINAL ONES.

Each Picus®|Picus® Nxt electronic pipette is tested before shipping by the manufacturer. The Sartorius Quality Assurance Procedure guarantees that the Picus®|Picus® Nxt electronic pipette you have purchased is ready for use. Each Picus®|Picus® Nxt electronic pipette is CE marked, fulfilling the requirements of EN 55014, 1993|EN 55104, 1995| ISO 13485:2003, and Directive (98|79 EC).

6. Hazardous Substances (RoHS II)

This product is in compliance with the European Directive RoHS II (2011/65/EC) on the restriction of hazardous substances in electrical and electronic equipment. The compliance is based on information provided by our supplier. Confirmation of compliance by our suppliers means that either the product does not contain any of the restricted substance(s), or the used concentrations are below the given threshold levels.

7. Disposal (WEEE)

In compliance with European Directive WEEE (2012/19/EU) on waste and reduction of hazardous substances of electrical and electronic equipment, it must not be disposed of as unsorted municipal waste. Instead this device must be collected separately in accordance with local recycling regulations. Batteries should also be disposed of in accordance with local legal regulations.

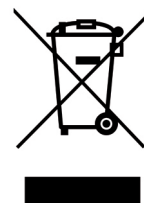

8. Troubleshooting

8.1. Hardware Reset

If the pipette becomes unresponsive it is possible to force a reset. This will not affect saved settings such as adjustments or memory. To turn off an unresponsive pipette, simultaneously press the on/off button and the right Softkey for a few seconds. The pipette will turn off and can then be turned on again by pressing the on/off button.

Note: Make sure the pipette is not on the charging unit or connected to the USB cable while being reset.

8.2. Troubleshooting Guide

Problem	Possible Cause	Solution
Leakage	<ul style="list-style-type: none">▪ Incompatible tip▪ Tip is loose▪ Pipette is dirty▪ Pipette is broken	<ul style="list-style-type: none">▪ Use original Sartorius tips▪ Attach the tip firmly▪ Clean the pipette▪ Replace the broken parts or send the pipette for service
Inaccuracy	<ul style="list-style-type: none">▪ Pipette is dirty▪ Pipette is broken	<ul style="list-style-type: none">▪ Clean the pipette▪ Replace the broken parts or send the pipette for service
Pipette is turned off	<ul style="list-style-type: none">▪ Pipette is in off mode▪ Empty battery	<ul style="list-style-type: none">▪ Turn the pipette on by pressing the on/off button▪ Connect the pipette to the charger
Piston is jammed	<ul style="list-style-type: none">▪ Inner lower parts are loose▪ Pipette is dirty▪ Pipette is broken	<ul style="list-style-type: none">▪ Open the bottom of the pipette and tighten the parts▪ Clean the pipette▪ Replace the broken parts or send the pipette for service
Pipette does not aspirate liquid properly	<ul style="list-style-type: none">▪ Safe-Cone Filter is dirty▪ Pipette is dirty▪ Pipette is broken	<ul style="list-style-type: none">▪ Replace the Safe-Cone Filter▪ Clean the pipette▪ Replace the broken parts or send the pipette for service

9. Technical Data

Rechargeable battery	
Type	Li-Polymer battery with protection circuit
Capacity	3.7 V 350 mAh
Charging time	Approx. 1 hour
Chargers, charging stands	
USB charger for Picus® Picus® Nxt pipette	
	For indoor and office equipment use only
Input voltage	100 – 240 V ~ 50 60 Hz, 125 mA
Output voltage	5 V DC, 1,400 mA
Output connector type	Micro-USB
Universal charger for charging stand for 1 pipette*	
Input voltage	According to local requirements
Output voltage	7.5 V DC, 800 mA
Universal charger for charging stand for 4 pipettes*	
Input voltage	According to local requirements
Output voltage	9 V DC, 2,000 mA
Picus® Picus® Nxt electronic pipette	
Operating temperature	+15°C to +40°C
Air humidity	Max. 80%
Weight	
Single-channel 10-300 µl	100 g
Single-channel 50-1,000 µl	110 g
8-channel 10-300 µl	160 g
Length	
Single-channel 10-300 µl	21.0 cm
Single-channel 50-1,000 µl	21.6 cm
8-channel 10-300 µl	21.6 cm
Pipetting force for single and multichannel models	1.3 N
Tip ejecting force for single and multichannel models	3.1 N

* All pipettes are supplied with a universal charger (EU, UK, US, JPN, AUS, KOR, and CHN plugs).

9.1. Performance Specifications

Picus® Nxt	Picus®	Channels		Volume Range	Increment	Test Volume	Mode P/D	Systematic Error ^N Limit ±	Random Error ^N Limit		
Order Code	Order Code			(µl)	(µl)	(µl)		(%)	(µl)	(%)	(µl)
LH-745021	735021	1	■	0.2 – 10	0.01	10	P	1.0	0.100	0.4	0.040
						5	P	1.2	0.060	0.7	0.035
						1	P	3.0	0.030	2.0	0.020
						0.2	P	17.5	0.035	10	0.020
						1	D	6.0	0.060	7.0	0.070
LH-745041	735041	1	■	5 – 120	0.10	120	P	0.5	0.60	0.15	0.18
						60	P	0.7	0.42	0.2	0.12
						12	P	2.0	0.24	1.0	0.12
						5	P	5.5	0.275	2.5	0.125
						12	D	4.0	0.48	4.0	0.48
LH-745061	735061	1	■	10 – 300	0.20	300	P	0.5	1.50	0.15	0.45
						150	P	0.6	0.90	0.2	0.30
						30	P	1.5	0.45	0.8	0.24
						10	P	5.0	0.50	2.4	0.24
						30	D	3.0	0.90	3.0	0.90
LH-745081	735081	1	■	50 – 1,000	1.00	1,000	P	0.45	4.5	0.15	1.5
						500	P	0.6	3.0	0.2	1.0
						100	P	2.0	2.0	0.5	0.5
						50	P	4.0	2.0	1.0	0.5
						100	D	2.5	2.5	2.0	2.0
LH-745101	735101	1	■	100 – 5,000	5.00	5,000	P	0.5	25	0.15	7.5
						2,500	P	0.7	17.5	0.2	5
						500	P	1.6	8	0.4	2
						100	P	8.0	8	2.0	2
						500	D	2.4	12	2.4	12
LH-745111	735111	1	■	500 – 10,000	10.00	10,000	P	0.6	60	0.2	20
						5,000	P	0.9	45	0.3	15
						1,000	P	3.0	30	0.6	6
						500	P	7.0	35	1.2	6
						1,000	D	4.0	40	2.4	24
LH-745321	735321	8	■	0.2 – 10	0.01	10	P	1.2	0.120	0.5	0.050
LH-745421	735421	12				5	P	1.5	0.075	0.8	0.040
						1	P	4.0	0.040	3.0	0.030
						0.2	P	25.0	0.050	15.0	0.030
						1	D	12.0	0.120	15.0	0.150
LH-745341	735341	8	■	5 – 120	0.10	120	P	0.6	0.72	0.3	0.36
LH-745441	735441	12				60	P	0.8	0.48	0.4	0.24
						12	P	2.5	0.30	1.67	0.20
						5	P	6.0	0.30	4.0	0.20
						12	D	4.5	0.54	8.0	0.96
LH-745361	735361	8	■	10 – 300	0.20	300	P	0.6	1.80	0.2	0.60
LH-745461	735461	12				150	P	0.8	1.20	0.3	0.45
						30	P	2.33	0.70	1.0	0.30
						10	P	8.0	0.80	3.0	0.30
						30	D	3.33	1.00	6.0	1.80
LH-745391	735391	8	■	50 – 1,200	1.00	1,200	P	0.6	7.2	0.2	2.4
LH-745491	735491	12				600	P	1.0	6.0	0.3	1.8
						120	P	2.5	3.0	1.0	1.2
						50	P	8.0	4.0	2.4	1.2
						120	D	3.33	4.0	3.33	4.0

^N Note: The listed systematic and random error values can be achieved only under strictly controlled conditions during type test per ISO 8655.

The best compatibility is achieved when combining Sartorius pipettes and Sartorius tips. The systematic error and random error results, in tests, have been achieved using Sartorius Optifit tips at factory default speed settings. Due to the continuous product development by Sartorius, the systematic and random error values are subject to change without prior notice.

^P P = Pipetting Mode

^D D = Multi-dispensing mode. The listed systematic and random error values are of 10 measurements at 10% of the nominal volume.

All pipettes are supplied with a universal charger (EU, UK, US | JPN, KOR, AUS and CHN plugs)

9.2. Speed Table

Speed is measured in Pipetting mode using the maximum volume.

In all main pipetting modes, speed can be adjusted separately for aspiration and dispensing.

The speed ranges from 1 (slow) to 9 (fast).

Single-channel pipettes (speed in seconds)						
Speed	10 µl	120 µl	300 µl	1,000 µl	5,000 µl	10,000 µl
1	2.5	6.0	7.7	10.1	10.2	10.2
2	1.8	4.2	5.3	7.4	7.4	7.4
3	1.3	2.9	3.7	5.4	5.4	5.4
4	1.0	2.1	2.7	3.8	3.8	3.8
5	0.8	1.5	1.9	2.8	2.7	2.9
6	0.6	1.1	1.4	1.9	1.8	2.2
7	0.5	0.9	1.1	1.2	1.1	1.7
8	0.4	0.7	0.9	0.8	0.8	1.3
9	0.3	0.6	0.8	0.6	0.6	0.9

Multichannel pipettes (speed in seconds)				
Speed	10 µl	120 µl	300 µl	1,200 µl
1	2.5	6.1	5.4	6.1
2	1.8	4.4	3.9	4.4
3	1.3	3.3	2.9	3.3
4	1.0	2.4	2.1	2.5
5	0.8	1.8	1.6	1.9
6	0.6	1.4	1.2	1.4
7	0.5	1.1	1.0	1.1
8	0.4	0.9	0.8	0.9
9	0.3	0.7	0.7	0.7

Sales and Service Contacts

For further contacts, visit
www.sartorius.com



Finland

Sartorius Biohit Liquid Handling
Laippatie 1
00880 Helsinki
Phone +358 9 755 951

Germany

Sartorius Lab Instruments
GmbH & Co. KG
Otto-Brenner-Strasse 20
37079 Goettingen
Phone +49 551 308 0

USA

Sartorius Corporation
5 Orville Drive, Suite 200
Bohemia, NY 11716
Phone +1 631 254 4249
Toll-free +1 800 635 2906