

---

# Waveform Generator

Trueform Series

This manual contains operating instruction, programming and service information. Always refer to the English version for latest edition.

# Safety and Regulatory Information

## Notices

© Keysight Technologies, Inc. 2013 - 2023

No part of this manual may be reproduced in any form or by any means (including electronic storage and retrieval or translation into a foreign language) without prior agreement and written consent from Keysight Technologies, Inc. as governed by United States and international copyright laws.

## Manual Information

Part Number: 33500-90901, Edition 6, December 2023

## Manufacturer Address

Keysight Technologies, Inc  
900 S. Taft Ave.  
Loveland, CO 80537 USA

## Software and Documentation Updates and Licenses

Keysight releases software updates to fix defects and incorporate product enhancements. For the latest firmware and documentation, see [www.keysight.com/find/trueform](http://www.keysight.com/find/trueform).

A portion of the software in this product is licensed under terms of the General Public License Version 2 ("GPLv2"). The text of the license and source code can be found at [www.keysight.com/find/GPLV2](http://www.keysight.com/find/GPLV2).

This product uses Microsoft Windows CE. Keysight highly recommends that all Windows-based computers connected to Windows CE instruments use current anti-virus software. For more information, see [www.keysight.com/find/trueform](http://www.keysight.com/find/trueform).

## Warranty

The material contained in this document is provided "as is," and is subject to being changed, without notice, in future editions. Further, to the maximum extent permitted by applicable law, Keysight disclaims all warranties, either express or implied, with regard to this manual and any information contained herein, including but not limited to the implied warranties of merchantability and fitness for a particular purpose. Keysight shall not be liable for errors or for incidental or consequential damages in connection with the furnishing, use, or performance of this document or of any information contained herein. Should Keysight and the user have a separate written agreement with warranty terms covering the material in this document that conflict with these terms, the warranty terms in the separate agreement shall control.

## Technology Licenses

The hardware and/or software described in this document are furnished under a license and may be used or copied only in accordance with the terms of such license.

## Restricted Rights Legend

If software is for use in the performance of a U.S. Government prime contract or subcontract, Software is delivered and licensed as "Commercial computer software" as defined in DFAR 252.227-7014 (June 1995), or as a "commercial item" as defined in FAR 2.101(a) or as "Restricted computer software" as defined in FAR 52.227-19 (June 1987) or any equivalent agency regulation or contract clause. Use, duplication or disclosure of Software is subject to Keysight Technologies' standard commercial license terms, and non-DOD Departments and Agencies of the U.S. Government will receive no greater than Restricted Rights as defined in FAR 52.227-19(c)(1-2) (June 1987). U.S. Government users will receive no greater than Limited Rights as defined in FAR 52.227-14 (June 1987) or DFAR 252.227-7015 (b)(2) (November 1995), as applicable in any technical data.

## Safety Notices

### CAUTION

A CAUTION notice denotes a hazard. It calls attention to an operating procedure, practice, or the like that, if not correctly performed or adhered to, could result in damage to the product or loss of important data. Do not proceed beyond a CAUTION notice until the indicated conditions are fully understood and met.

### WARNING

A WARNING notice denotes a hazard. It calls attention to an operating procedure, practice, or the like that, if not correctly performed or adhered to, could result in personal injury or death. Do not proceed beyond a WARNING notice until the indicated conditions are fully understood and met.

## Safety Symbols



Alternating current

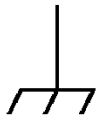

Frame or chassis terminal



Standby supply. Unit is not completely disconnected from AC mains when switch is off.



**WARNING** Risk of electric shock



**CAUTION** Refer to accompanying documents



Protective Earth ground terminal (safety ground)



The CE mark is a registered trademark of the European Community.



The ETL mark is a registered trademark of Intertek. Applies to 33500 Series instruments only.



The CSA mark with the 'c' and 'us' subscript indicates the instrument is certified to the applicable Canadian and United States of America standards respectively. Applies to 33600 Series instruments only.



N10149

The C-tick mark is a registered trademark of the Spectrum Management Agency of Australia. This signifies compliance with the Australian EMC Framework regulations under the terms of the Radio Communications Act of 1992.



Contains one or more of the 6 hazardous substances above the maximum concentration value (MCV), 40 Year EPUP.

1SM 1-A

This text indicates that the instrument is an Industrial Scientific and Medical Group 1 Class A product (CISPR 11, Clause 4).

ICES/NMB-001

This ISM device complies with Canadian ICES-001. Cet appareil ISM est conforme à la norme NMB-001 du Canada.



This product complies with the WEEE Directive (2002/96/EC) marking equipment. The affixed product label indicates that you must not discard this electrical/electronic product in domestic household waste.

To return unwanted products, contact your local Keysight office, or see [www.keysight.com/environment/product/](http://www.keysight.com/environment/product/) for more information.



This equipment is Class A suitable for professional use and is for use in electromagnetic environments outside of the home.

이 기기는 업무용 (A 급) 전자파적합기기로서 판매자 또는 사용자는 이 점을 주의하시기 바라며, 가정외의 지역에서 사용하는 것을 목적으로 합니다.

## Product Regulatory and Compliance

The Trueform Series waveform generator complies with safety and EMC requirements.

Refer to Declaration of Conformity at <http://www.keysight.com/go/conformity> for the latest revision.

## Additional Safety Notices

The following general safety precautions must be observed during all phases of operation of this instrument. Failure to comply with these precautions or with specific warnings or instructions elsewhere in this manual violates safety standards of design, manufacture, and intended use of the instrument. Keysight Technologies assumes no liability of the customer's failure to comply with the requirements.

### General

Do not use this product in any manner not specified by the manufacturer. The protective features of this product may be impaired if it is used in a manner not specified in the operation instructions.

### Before Applying Power

Verify that all safety precautions are taken. Make all connections to the unit before applying power.

### Ground the Instrument

This product is provided with protective earth terminals. To minimize shock hazard, the instrument must be connected to the AC power mains through a grounded power cable, with the ground wire firmly connected to an electrical ground (safety ground) at the power outlet. Any interruption of the protective (grounding) conductor or disconnection of the protective earth terminal will cause a potential shock hazard that could result in personal injury.

- Do not operate in an explosive atmosphere.
- Do not operate the instrument in the presence of flammable gases or fumes, and wet environments.
- Only qualified, service-trained personnel who are aware of the hazards involved should remove instrument covers. Always disconnect the power cable and any external circuits before removing the instrument cover.

### Do Not Modify the Instrument

Do not install substitute parts or perform any unauthorized modification to the product. Return the product to an Keysight Sales and Service Office for service and repair to ensure that safety features are maintained.

### In Case of Damage

Instruments that appear damaged or defective should be made inoperative and secured against unintended operation until they can be repaired by qualified service personnel.

#### **CAUTION**

Unless otherwise noted in the specifications, this instrument or system is intended for indoor use in an installation category II, pollution degree 2 environment per IEC 61010-1 and 664 respectively. It is

designed to operate at a maximum relative humidity of 80% RH at 40 °C and decrease linearly to 37.5% RH at 55 °C. At temperature between 40 and 55 °C, the maximum relative humidity follows the line of constant dew point. This instrument or system is designed to operate at altitudes up to 3000 meters, and at temperatures between 0 and 55 °C.

## Technical Support

If you have questions about your shipment, or if you need information about warranty, service, or technical support, **contact Keysight Technologies.**

## Declaration of Conformity

Declarations of Conformity for this product and for other Keysight products may be downloaded from the Keysight Regulatory Web site:

<http://regulations.products.keysight.com/DoC/search.htm>

<b>Safety and Regulatory Information</b> .....	<b>2</b>
<b>Notices</b> .....	<b>2</b>
Manual Information .....	2
<b>Manufacturer Address</b> .....	<b>2</b>
Software and Documentation Updates and Licenses .....	2
Warranty .....	2
Technology Licenses .....	2
Restricted Rights Legend .....	3
<b>Safety Notices</b> .....	<b>3</b>
<b>Safety Symbols</b> .....	<b>3</b>
<b>Product Regulatory and Compliance</b> .....	<b>4</b>
<b>Additional Safety Notices</b> .....	<b>5</b>
General .....	5
Before Applying Power .....	5
Ground the Instrument .....	5
Do Not Modify the Instrument .....	5
In Case of Damage .....	5
Technical Support .....	6
Declaration of Conformity .....	6
<b>Keysight Trueform Series Waveform Generator Operation and Service Guide</b> .....	<b>14</b>
<b>Keysight BenchVue Software</b> .....	<b>15</b>
Use BenchVue to: .....	15
Save time with: .....	15
From anywhere: .....	15
<b>Preliminary Information</b> .....	<b>16</b>
<b>Operating Information</b> .....	<b>16</b>
<b>SCPI Programming Reference</b> .....	<b>16</b>
<b>Service and Repair Information</b> .....	<b>17</b>
<b>IO Libraries and Instrument Drivers</b> .....	<b>17</b>
<b>Web Interface</b> .....	<b>18</b>
<b>Example Programs</b> .....	<b>18</b>
<b>Contacting Keysight Technologies</b> .....	<b>19</b>
<b>Models and Options</b> .....	<b>20</b>
<b>Instrument Models</b> .....	<b>20</b>
<b>One- and two-channel upgrades for 33500 Series</b> .....	<b>21</b>
<b>One- and two-channel upgrades for 33600 Series</b> .....	<b>22</b>
<b>Models and Options</b> .....	<b>22</b>
Instrument Models .....	22
One- and two-channel upgrades for 33500 Series .....	24
One- and two-channel upgrades for 33600 Series .....	24
<b>Maximum Waveform Frequencies by Model</b> .....	<b>24</b>
33500 Series, Lower Frequency Models .....	24
33500 Series, Higher Frequency Models .....	25
33600 Series, Lower Frequency Models .....	25
33600 Series, Higher Frequency Models .....	26
<b>Operating Information</b> .....	<b>28</b>
<b>Introduction to Instrument</b> .....	<b>28</b>
Instrument at a Glance .....	28
Front Panel at a Glance .....	30
Front Panel Display at a Glance .....	31
Front Panel Number Entry .....	32

Rear Panel at a Glance .....	33
<b>Quick Start</b> .....	<b>35</b>
Prepare Instrument for Use .....	36
Adjust the Carrying Handle .....	37
Set Output Frequency .....	38
Set Output Amplitude .....	40
Set DC Offset Voltage .....	42
Set High-Level and Low-Level Values .....	44
Output a DC Voltage .....	45
Set Duty Cycle of a Square Wave .....	46
Configure a Pulse Waveform .....	47
Select a Stored Arbitrary Waveform .....	48
Use Built-in Help System .....	49
Rack Mount the Instrument .....	51
<b>Front Panel Menu Operation</b> .....	<b>52</b>
Select Output Termination .....	53
Reset the Instrument .....	53
Output a Modulated Waveform .....	54
Output an FSK Waveform .....	55
Output a PWM Waveform .....	56
Output a Frequency Sweep .....	58
Output a Burst Waveform .....	60
Trigger a Sweep or Burst .....	62
Store or Retrieve the Instrument State .....	63
Front Panel Menu Reference .....	65
LAN Configuration Procedure .....	71
Set Up an Arbitrary Waveform .....	74
<b>Features and Functions</b> .....	<b>86</b>
Output Configuration .....	86
Pulse Waveforms .....	101
Amplitude Modulation (AM) and Frequency Modulation (FM) .....	107
Phase Modulation (PM) .....	115
Frequency-Shift Keying (FSK) Modulation .....	121
Pulse Width Modulation (PWM) .....	123
Sum Modulation .....	128
Frequency Sweep .....	132
Burst Mode .....	140
Triggering .....	148
Dual Channel Operations .....	152
IQ Player (Optional) .....	155
System-Related Operations .....	158
Remote Interface Configuration .....	164
External Timebase Reference .....	171
Embedded Waveform Editor .....	173
<b>Waveform Generation Tutorial</b> .....	<b>190</b>
Arbitrary Waveforms .....	191
Quasi-Gaussian Noise .....	193
PRBS .....	194
Modulation .....	195
Burst .....	199
Frequency Sweep .....	200
Attributes of AC Signals .....	201
Signal Imperfections .....	203



Ground Loops .....	204
<b>SCPI Programming Reference .....</b>	<b>206</b>
<b>Introduction to the SCPI Language .....</b>	<b>206</b>
Syntax Conventions .....	206
Command Separators .....	207
Using the MIN, MAX, and DEF Parameters .....	207
Querying Parameter Settings .....	208
SCPI Command Terminators .....	208
IEEE-488.2 Common Commands .....	208
SCPI Parameter Types .....	209
Using Device Clear .....	210
<b>Internal Function Waveforms .....</b>	<b>210</b>
See Also .....	212
<b>Alphabetical List of SCPI Commands and Queries .....</b>	<b>212</b>
ABORt .....	214
AM Subsystem .....	214
APPLy Subsystem .....	221
BPSK Subsystem .....	231
BURSt Subsystem .....	236
CALibration Subsystem .....	242
[SOURce[1 2]:]COMBine:FEED {CH1 CH2 NONE}[SOURce[1 2]:]COMBine:FEED? .....	246
DATA Subsystem .....	247
DISPlay Subsystem .....	257
FM Subsystem .....	261
FORMat:BORDer {NORMal SWAPped}FORMat:BORDer? .....	268
FREQuency Subsystem .....	268
FSKey Subsystem .....	274
FUNCTion Subsystem .....	279
HCOPy Subsystem .....	303
IEEE-488 Common Commands .....	304
INITiate Subsystem .....	316
INPut:ATTenuation[:STATe] {ON OFF 0}INPut:ATTenuation[:STATe]? .....	318
LIST Subsystem .....	318
LXI Subsystem .....	319
MARKer Subsystem .....	322
MEMory Subsystem .....	324
MMEMory Subsystem .....	327
OUTPut Subsystem .....	339
PHASe Subsystem .....	347
PM Subsystem .....	351
PWM Subsystem .....	358
RATE Subsystem .....	365
ROSCillator Subsystem .....	367
SOURce Subsystem .....	370
STATus Subsystem Introduction .....	372
SUM Subsystem Introduction .....	379
SWEep Subsystem Introduction .....	385
SYSTem Subsystem .....	387
[SOURce[1 2]:]TRACK {ON OFF INVERTed}TRACK? .....	408
TRIGger Subsystem Introduction .....	410
UNIT:ANGLE {DEGREE RADIan SECOnd DEFAULT}UNIT:ANGLE? .....	414
UNIT:ARbitrary:ANGLE {DEGREE RADIan SECOnd SAMPLE DEFAULT}UNIT:ARbitrary:ANGLE? .....	416

VOLTage Subsystem Introduction .....	416
<b>Programming Examples .....</b>	<b>425</b>
Configure a Sine Wave .....	425
Configure a Square Wave .....	426
Configure a Ramp Wave .....	427
Configure a Pulse Wave .....	428
Create a List of Frequencies .....	429
Configure an arbitrary waveform .....	429
<b>Keysight Trueform Series Command Quick Reference .....</b>	<b>431</b>
<b>Factory Reset State .....</b>	<b>448</b>
<b>SCPI Error Messages .....</b>	<b>454</b>
<b>Service and Repair - Introduction .....</b>	<b>470</b>
<b>Types of Service Available .....</b>	<b>470</b>
Extended Service Contracts .....	470
Obtaining Repair Service (Worldwide) .....	470
Repackaging for Shipment .....	471
<b>Cleaning .....</b>	<b>471</b>
<b>Electrostatic Discharge (ESD) Precautions .....</b>	<b>471</b>
<b>Introduction to Calibration - 33500 Series .....</b>	<b>472</b>
Keysight Technologies Calibration Services .....	472
Calibration Table of Contents .....	472
Calibration Overview - 33500 Series .....	474
Calibration Security - 33500 Series .....	477
Verification - 33500 Series .....	479
Performance Verification Tests - 33500 Series .....	479
Internal Timebase Verification - 33500 Series .....	481
AC Amplitude (high-impedance) Verification - 33500 Series .....	482
DC Offset Voltage Verification - 33500 Series .....	483
-8 dB Range Flatness Verification - 33500 Series .....	484
-24 dB Range Flatness Verification - 33500 Series .....	486
General Calibration/Adjustment Procedure - 33500 Series .....	488
Aborting a Calibration in Progress - 33500 Series .....	488
Sequence of Adjustments - 33500 Series .....	489
Self-Test - 33500 Series .....	489
Frequency (Internal Timebase) Adjustment - 33500 Series .....	489
Internal ADC Adjustment - 33500 Series .....	490
Self Calibration Adjustment - 33500 Series .....	491
Output Impedance Adjustment - 33500 Series .....	492
AC Amplitude (high-impedance) Adjustment - 33500 Series .....	493
-24 dB Range Flatness Adjustment - 33500 Series .....	495
-8 dB Range Flatness Adjustment - 33500 Series .....	497
Channel 2 Adjustments - 33500 Series .....	498
Calibration Errors - 33500 Series .....	505
<b>Introduction to Calibration - 33600 Series .....</b>	<b>507</b>
Keysight Technologies Calibration Services .....	507
Calibration Table of Contents .....	507
Calibration Overview - 33600 Series .....	508
Calibration Security - 33600 Series .....	512
Verification - 33600 Series .....	513
Performance Verification Tests - 33600 Series .....	514
Internal Timebase Verification - 33600 Series .....	515
AC Amplitude (high-impedance) Verification - 33600 Series .....	516

DC Offset Voltage Verification - 33600 Series .....	516
1 Vpp Range Flatness Verification - 33600 Series .....	517
4 Vpp Range Flatness Verification - 33600 Series .....	521
8 Vpp Range Flatness Verification - 33600 Series .....	525
General Calibration/Adjustment Procedure - 33600 Series .....	530
Aborting a Calibration in Progress - 33600 Series .....	530
Sequence of Adjustments - 33600 Series .....	531
Self-Test - 33600 Series .....	531
Frequency (Internal Timebase) Adjustment - 33600 Series .....	531
Internal ADC Adjustment - 33600 Series .....	532
Self Calibration Adjustment - 33600 Series .....	533
Output Impedance Adjustment - 33600 Series .....	534
AC Amplitude (high-impedance) Adjustment - 33600 Series .....	535
1 Vpp Flatness Adjustment - 33600 Series .....	538
4 Vpp Flatness Adjustment - 33600 Series .....	540
8 Vpp Flatness Adjustment - 33600 Series .....	542
Channel 2 Adjustments - 33600 Series .....	544
Calibration Errors - 33600 Series .....	555
<b>Block Diagram - 33500 Series .....</b>	<b>556</b>
Block Diagram - 33500 Series .....	558
<b>Block Diagram - 33600 Series .....</b>	<b>558</b>
Block Diagram - 33600 Series .....	561
<b>Power Supplies - 33500 Series .....</b>	<b>561</b>
<b>Power Supplies - 33600 Series .....</b>	<b>562</b>
<b>Troubleshooting - 33500 Series .....</b>	<b>562</b>
Unit is Inoperative .....	563
Unit Fails Self-Test .....	563
Power Supplies .....	563
Self-Test Errors 605 - 609 .....	564
10 MHz Out .....	566
<b>Troubleshooting - 33600 Series .....</b>	<b>566</b>
Unit is Inoperative .....	567
Unit Fails Self-Test .....	567
Power Supplies .....	567
Self-Test Errors 607 through 611 .....	569
10 MHz Out .....	571
<b>Self-Test Procedures .....</b>	<b>571</b>
Power-On Self-Test .....	571
Full Self-Test .....	572
To Run Self-Test .....	572
Self-Test Error Numbers and Messages (33500 Series) .....	572
Self-Test Error Numbers and Messages (33600 Series) .....	575
<b>Replaceable Parts .....</b>	<b>579</b>
<b>Disassembly - 33500 Series .....</b>	<b>580</b>
Tools Required .....	580
General Disassembly Procedure .....	581
Main Component Disassembly .....	583
Front Panel Disassembly .....	586
<b>Disassembly - 33600 Series .....</b>	<b>587</b>
Tools Required .....	588
General Disassembly Procedure .....	588
Main Component Disassembly .....	590
To remove the main board .....	590

---

<b>Battery Replacement</b> .....	<b>591</b>
Tools Required .....	592
Procedure .....	593
<b>Installing the Optional GPIB Interface</b> .....	<b>594</b>
Tools Required .....	594
Installation Procedure .....	594
Retain GPIB Cover Plate .....	594
<b>Index</b> .....	<b>596</b>



# Keysight Trueform Series Waveform Generator Operation and Service Guide

This document includes user, service, and programming information for the Keysight Trueform Series waveform generators.

For the latest firmware and documentation, see [www.keysight.com/find/trueform](http://www.keysight.com/find/trueform).

For the latest datasheet with all specifications and typical characteristics, see [literature.cdn.keysight.com/litweb/pdf/5991-3272EN.pdf](http://literature.cdn.keysight.com/litweb/pdf/5991-3272EN.pdf).

Keysight welcomes your comments and suggestions to improve our documentation. You can give feedback on this document at [www.keysight.com/find/trueformdocfeedback](http://www.keysight.com/find/trueformdocfeedback).

## Keysight BenchVue Software

The Keysight Trueform Series waveform generators work with BenchVue software, which provides easy multi-instrument control. For more information, go to [www.keysight.com/find/benchvue](http://www.keysight.com/find/benchvue).



Use BenchVue to:

- View and control all of your bench instruments from a single screen
- Save/recall the state of your entire bench
- Acquire data and screenshots from multiple instruments

Save time with:

- Time aligned multi-instrument export to Excel, Word, MATLAB
- Export of waveform generator data to Word
- Drag and drop waveforms between your waveform generator and oscilloscope
- Integrated library capability for downloading instrument documentation, software drivers, firmware updates, FAQs, videos, and more

From anywhere:

- Mobile companion apps to monitor and control your bench

## Preliminary Information

[Safety and Regulatory Information](#)

[Models and Options](#)

[Maximum Waveform Frequencies by Model](#)

## Operating Information

[Introduction to Instrument](#)

[Quick Start](#)

[Front Panel Menu Operation](#)

[Front Panel Menu Reference](#)

[LAN Configuration Procedure](#)

[Set Up Arbitrary Waveform](#)

[Features and Functions](#)

[Waveform Generation Tutorial](#)

## SCPI Programming Reference

[Introduction to SCPI Language](#)

[Internal Function Waveforms](#)

[Alphabetical List of SCPI Commands and Queries](#)

[Programming Examples](#)

[Command Quick Reference](#)

[Factory Reset State](#)

[SCPI Error Messages](#)



## Service and Repair Information

[Service and Repair Introduction](#)

[Calibration and Adjustment: 33500 Series](#)

[Calibration and Adjustment: 33600 Series](#)

[Block Diagram - 33500 Series](#)

[Block Diagram - 33600 Series](#)

[Power Supplies - 33500 Series](#)

[Power Supplies - 33600 Series](#)

[Troubleshooting - 33500 Series](#)

[Troubleshooting - 33600 Series](#)

[Self-Test Procedures](#)

[Replaceable Parts](#)

[Disassembly - 33500 Series](#)

[Disassembly - 33600 Series](#)

[Battery Replacement](#)

[Installing the Optional GPIB Interface](#)

## IO Libraries and Instrument Drivers

The Keysight IO Libraries can be downloaded from [www.keysight.com/find/iosuite](http://www.keysight.com/find/iosuite). For information about connecting instruments to USB, LAN and GPIB interfaces and how to configure and troubleshoot these interfaces, refer to Keysight IO Libraries help.

## Web Interface

The instrument includes a built-in Web Interface. You can use this interface over LAN for remote instrument access and control via a Java™-enabled Web browser, such as Microsoft Internet Explorer.

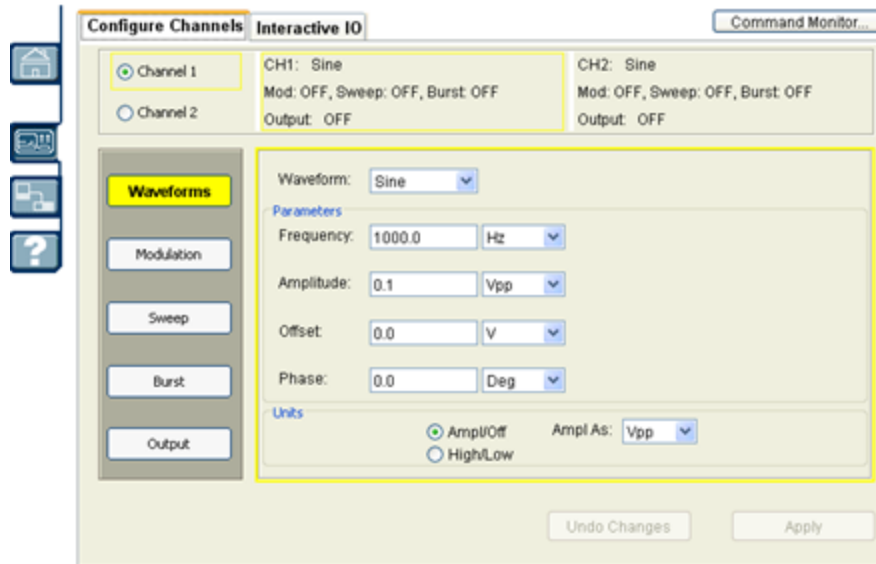

To use the Web Interface:

1. Establish a LAN connection from your PC to the instrument.
2. Open your PC's Web browser.
3. Launch the instrument's Web Interface by entering the instrument's IP address or fully-qualified hostname in the browser address field.
4. Follow the instructions in the Web Interface's on-line help.

## Example Programs

There are several example programs on the product page Web site ([www.keysight.com/find/trueform](http://www.keysight.com/find/trueform)). These are application-focused programs that demonstrate different programming environments. This document also includes [programming examples](#) to help get you started.

## Contacting Keysight Technologies



You can contact Keysight Technologies for warranty, service, or technical support.

In the United States: (800) 829-4444

In Europe: 31 20 547 2111

In Japan: 0120-421-345

Use [www.keysight.com/find/assist](http://www.keysight.com/find/assist) for information on contacting Keysight worldwide, or contact your Keysight Technologies representative.

## Models and Options

This section describes the models and options in the Trueform Series of instruments. For information on loading licenses for options via the front panel, see [License Installation](#). For information on loading licenses via SCPI, see the [SYSTEM:LICense commands](#).

### Instrument Models

Instrument models with numbers of the form 335XXA or 335XXB are referred to as the 33500 Series, and instrument models with numbers of the form 336XXA are referred to as the 33600 Series. Collectively, the 33500 Series and 33600 Series instruments comprise the Trueform Series of waveform generators. Unless specified otherwise, all manual topics apply to all instruments in the Trueform Series.

To determine the model number of your instrument, read the label on the instrument's front panel. You can also either execute the \*IDN? query over the remote interface or press **[System] > Help > About** on the front panel.

The Trueform Series model numbers and option numbers are shown and described in the table below.

Model	Description	Options
33521A	30 MHz One channel Arbitrary waveforms NISPOM Security 1 MSa Memory per channel	002 - 16MSa Arb Memory 004 - GPIB Interface 010 - High-stability OCXO Timebase
33522A	30 MHz Two channels Arbitrary waveforms NISPOM Security 1 MSa memory per channel	002 - 16MSa Arb Memory 004 - GPIB Interface 010 - High-stability OCXO Timebase
33509B	20 MHz One channel No arbitrary waveforms	OCX - Add High-stability OCXO Timebase SEC - Enable NISPOM & File Security
33510B	20 MHz Two channels No arbitrary waveforms	OCX - Add High-stability OCXO Timebase SEC - Enable NISPOM & File Security
33511B	20 MHz One channel Arbitrary waveforms	MEM - 16 MSa Memory per channel OCX - Add High-stability OCXO Timebase SEC - Enable NISPOM & File Security
33512B	20 MHz Two channels Arbitrary waveforms	MEM - 16 MSa Memory per channel OCX - Add High-stability OCXO Timebase SEC - Enable NISPOM & File Security IQP - IQ Baseband signal player
33519B	30 MHz One channel No arbitrary waveforms	OCX - Add High-stability OCXO Timebase SEC - Enable NISPOM & File Security

## Models and Options

Model	Description	Options
33520B	30 MHz Two channels No arbitrary waveforms	OCX - Add High-stability OCXO Timebase SEC - Enable NISPOM & File Security
33521B	30 MHz One channel Arbitrary waveforms	MEM - 16 MSa Memory per channel OCX - Add High-stability OCXO Timebase SEC - Enable NISPOM & File Security
33522B	30 MHz Two channels Arbitrary waveforms	MEM - 16 MSa Memory per channel OCX - Add High-stability OCXO Timebase SEC - Enable NISPOM & File Security IQP - IQ Baseband signal player
33611A	80 MHz One channel Arbitrary waveforms	MEM - 64 MSa Memory per channel OCX - Add High-stability OCXO Timebase SEC - Enable NISPOM & File Security
33612A	80 MHz Two channels Arbitrary waveforms	MEM - 64 MSa Memory per channel OCX - Add High-stability OCXO Timebase SEC - Enable NISPOM & File Security IQP - IQ Baseband signal player
33621A	120 MHz One channel Arbitrary waveforms	MEM - 64 MSa Memory per channel OCX - Add High-stability OCXO Timebase SEC - Enable NISPOM & File Security GPB - GPIB interface module – factory installed
33622A	120 MHz Two channels Arbitrary waveforms	MEM - 64 MSa Memory per channel OCX - Add High-stability OCXO Timebase SEC - Enable NISPOM & File Security IQP - IQ Baseband signal player GPB - GPIB interface module – factory installed

## One- and two-channel upgrades for 33500 Series

Model	Description
335BW1U	Increase bandwidth to 30 MHz for one-channel models
335BW2U	Increase bandwidth to 30 MHz for two-channel models
335ARB1U	Add arbitrary waveforms to one-channel models
335ARB2U	Add arbitrary waveforms to two-channel models
335MEM1U	16 MSa per channel memory for one-channel models
335MEM2U	16 MSa per channel memory for two-channel models
33500U-OCX	Add high-stability OCXO timebase
335SECU	Add NISPOM and File security
33522B-DST	Enable all software options for demonstration

## One- and two-channel upgrades for 33600 Series

Model	Description
336BW1U	Increase bandwidth to 120 MHz for one-channel models
336BW2U	Increase bandwidth to 120 MHz for two-channel models
336MEM1U	64 MSa per channel memory for one-channel models
336MEM2U	64 MSa per channel memory for two-channel models
33600U-OCX	Add high-stability OCXO timebase
336SECU	Add NISPOM and File security
33622A-DST	Enable all software options for demonstration
3446GPBU	GPIB user installable interface module

## Models and Options

This section describes the models and options in the Trueform Series of instruments. For information on loading licenses for options via the front panel, see [License Installation](#). For information on loading licenses via SCPI, see the [SYSTEM:License commands](#).

### Instrument Models

Instrument models with numbers of the form 335XXA or 335XXB are referred to as the 33500 Series, and instrument models with numbers of the form 336XXA are referred to as the 33600 Series. Collectively, the 33500 Series and 33600 Series instruments comprise the Trueform Series of waveform generators. Unless specified otherwise, all manual topics apply to all instruments in the Trueform Series.

To determine the model number of your instrument, read the label on the instrument's front panel. You can also either execute the \*IDN? query over the remote interface or press **[System] > Help > About** on the front panel.

The Trueform Series model numbers and option numbers are shown and described in the table below.

Model	Description	Options
33521A	30 MHz One channel Arbitrary waveforms NISPOM Security 1 MSa Memory per channel	002 - 16MSa Arb Memory 004 - GPIB Interface 010 - High-stability OCXO Timebase
33522A	30 MHz Two channels Arbitrary waveforms NISPOM Security 1 MSa memory per channel	002 - 16MSa Arb Memory 004 - GPIB Interface 010 - High-stability OCXO Timebase

## Models and Options

<b>Model</b>	<b>Description</b>	<b>Options</b>
33509B	20 MHz One channel No arbitrary waveforms	OCX - Add High-stability OCXO Timebase SEC - Enable NISPOM & File Security
33510B	20 MHz Two channels No arbitrary waveforms	OCX - Add High-stability OCXO Timebase SEC - Enable NISPOM & File Security
33511B	20 MHz One channel Arbitrary waveforms	MEM - 16 MSa Memory per channel OCX - Add High-stability OCXO Timebase SEC - Enable NISPOM & File Security
33512B	20 MHz Two channels Arbitrary waveforms	MEM - 16 MSa Memory per channel OCX - Add High-stability OCXO Timebase SEC - Enable NISPOM & File Security IQP - IQ Baseband signal player
33519B	30 MHz One channel No arbitrary waveforms	OCX - Add High-stability OCXO Timebase SEC - Enable NISPOM & File Security
33520B	30 MHz Two channels No arbitrary waveforms	OCX - Add High-stability OCXO Timebase SEC - Enable NISPOM & File Security
33521B	30 MHz One channel Arbitrary waveforms	MEM - 16 MSa Memory per channel OCX - Add High-stability OCXO Timebase SEC - Enable NISPOM & File Security
33522B	30 MHz Two channels Arbitrary waveforms	MEM - 16 MSa Memory per channel OCX - Add High-stability OCXO Timebase SEC - Enable NISPOM & File Security IQP - IQ Baseband signal player
33611A	80 MHz One channel Arbitrary waveforms	MEM - 64 MSa Memory per channel OCX - Add High-stability OCXO Timebase SEC - Enable NISPOM & File Security
33612A	80 MHz Two channels Arbitrary waveforms	MEM - 64 MSa Memory per channel OCX - Add High-stability OCXO Timebase SEC - Enable NISPOM & File Security IQP - IQ Baseband signal player
33621A	120 MHz One channel Arbitrary waveforms	MEM - 64 MSa Memory per channel OCX - Add High-stability OCXO Timebase SEC - Enable NISPOM & File Security GPB - GPIB interface module – factory installed
33622A	120 MHz Two channels Arbitrary waveforms	MEM - 64 MSa Memory per channel OCX - Add High-stability OCXO Timebase SEC - Enable NISPOM & File Security IQP - IQ Baseband signal player GPB - GPIB interface module – factory installed

## One- and two-channel upgrades for 33500 Series

Model	Description
335BW1U	Increase bandwidth to 30 MHz for one-channel models
335BW2U	Increase bandwidth to 30 MHz for two-channel models
335ARB1U	Add arbitrary waveforms to one-channel models
335ARB2U	Add arbitrary waveforms to two-channel models
335MEM1U	16 MSa per channel memory for one-channel models
335MEM2U	16 MSa per channel memory for two-channel models
33500U-OCX	Add high-stability OCXO timebase
335SECU	Add NISPOM and File security
33522B-DST	Enable all software options for demonstration

## One- and two-channel upgrades for 33600 Series

Model	Description
336BW1U	Increase bandwidth to 120 MHz for one-channel models
336BW2U	Increase bandwidth to 120 MHz for two-channel models
336MEM1U	64 MSa per channel memory for one-channel models
336MEM2U	64 MSa per channel memory for two-channel models
33600U-OCX	Add high-stability OCXO timebase
336SECU	Add NISPOM and File security
33622A-DST	Enable all software options for demonstration
3446GPBU	GPIB user installable interface module

## Maximum Waveform Frequencies by Model

## 33500 Series, Lower Frequency Models

**33509B 33510B 33511B 33512B**

Waveform	Maximum Frequency
Sine	20 MHz



## Models and Options

Waveform	Maximum Frequency
Square/Pulse	20 MHz
Noise	20 MHz
Ramp/Triangle	200 kHz
PRBS	50 Mbps
Arbitrary	160 MSa/s

## 33500 Series, Higher Frequency Models

**33521A 33522A 33519B 33520B 33521B 33522B** or other 33500 Series models with option **335BW1U** or **335BW2U**.

Waveform	Maximum Frequency
Sine	30 MHz
Square/Pulse	30 MHz
Noise	30 MHz
Ramp/Triangle	200 kHz
PRBS	50 Mbps
Arbitrary	250 MSa/s

## 33600 Series, Lower Frequency Models

**33611A 33612A**

Waveform	Maximum Frequency
Sine	60 MHz up to 10 Vpp 80 MHz up to 8 Vpp
Square/Pulse	50 MHz up to 10 Vpp
Noise	60 MHz up to 10 Vpp 80 MHz up to 8 Vpp
Ramp/Triangle	800 kHz
PRBS	100 Mbps
Arbitrary	660 MSa/s

## 33600 Series, Higher Frequency Models

33621A 33622A or other 33600 Series models with option 336BW1U or 336BW2U.

Waveform	Maximum Frequency
Sine	60 MHz up to 10 Vpp 80 MHz up to 8 Vpp 120 MHz up to 4 Vpp
Square/Pulse	50 MHz up to 10 Vpp 100 MHz up to 4 Vpp
Noise	60 MHz up to 10 Vpp 80 MHz up to 8 Vpp 120 MHz up to 4 Vpp
Ramp/Triangle	800 kHz
PRBS	100 Mbps up to 10 Vpp 200 Mbps up to 4 Vpp
Arbitrary	1 GSa/s



# Operating Information

[Introduction to Instrument](#)

[Quick Start](#)

[Front Panel Menu Operation](#)

[Front Panel Menu Reference](#)

[LAN Configuration Procedure](#)

[Set Up Arbitrary Waveform](#)

[Features and Functions](#)

[Waveform Generation Tutorial](#)

## Introduction to Instrument

The Keysight Technologies Trueform Series is a series of synthesized waveform generators with built-in arbitrary waveform and pulse capabilities.

[Instrument at a Glance](#)

[Front Panel at a Glance](#)

[Front Panel Display at a Glance](#)

[Front Panel Number Entry](#)

[Rear Panel at a Glance](#)

## Instrument at a Glance

The instrument's combination of bench-top and system features makes it a versatile solution now and in the future.

### Convenient bench-top features

- 16 standard waveforms
- Built-in 16-bit (33500 Series) or 14-bit (33600 Series) arbitrary waveform capability
- Precise pulse waveform capabilities with adjustable edge time
- LCD display with numeric and graphical views
- Easy-to-use knob and numeric keypad
- Instrument state storage with user-defined names
- Portable, ruggedized case with non-skid feet
- Isolated outputs to break ground loops

### Flexible system features

- Downloadable waveform memory of 1MSa (33500 Series) or 4 MSa (33600 Series). This can be **upgraded to 16 MSa (33500 Series) or 64 MSa (33600 Series)**.
- USB, GPIB, and LAN remote interfaces (GPIB is optional on some models; see **Models and Options** for details.)
- LXI Class C Compliant
- SCPI (Standard Commands for Programmable Instruments) compatibility

## Front Panel at a Glance

**WARNING**

The BNC connectors, both the shell and center pin, on the front panel of the instrument are isolated up to  $\pm 42$  Vpk from chassis. The shells of these BNC connectors are connected to each other, and internal circuitry will attempt to keep the isolated voltage to within  $\pm 42$  Vpk to chassis. Exceeding the isolation voltage beyond  $\pm 42$  Vpk from chassis may destroy the instrument and cause a hazard that could result in personal injury or death.

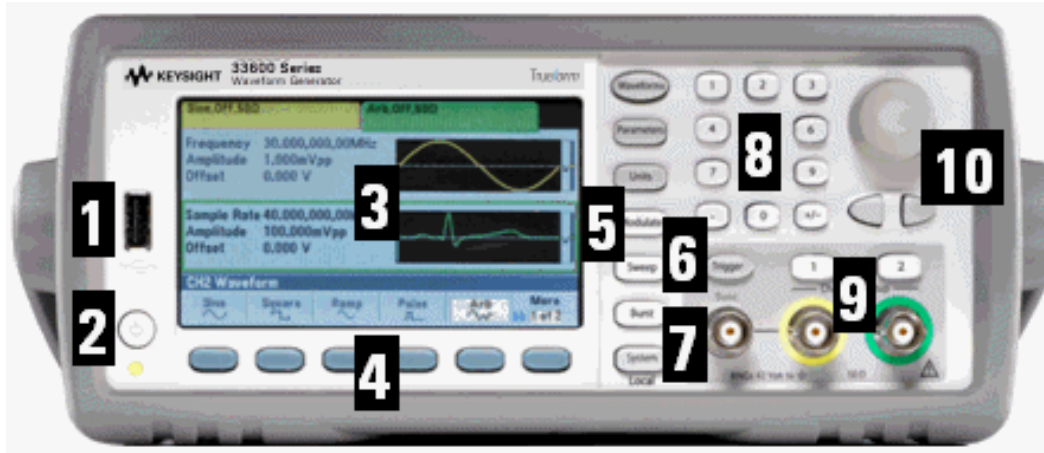

Item	Description
1	USB Port
2	On/Off Standby Switch
3	Display
4	Menu Softkeys
5	Fixed Function Buttons (column of seven keys)
6	Manual Trigger Button
7	Sync Connector
8	Numeric Keypad
9	Channel 1 and Channel 2 (depending on model)
10	Knob and cursor arrows

**NOTE**

Press and hold any front panel key or softkey to get context-sensitive help.

## Front Panel Display at a Glance

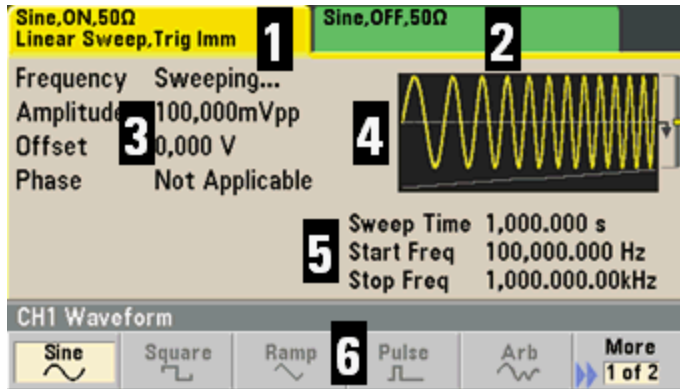

Item	Description
1	Channel 1 information
2	Channel 2 information (depends on model)
3	Waveform parameters
4	Waveform display
5	Sweep, modulation, or burst parameters
6	Softkey labels

## Front Panel Number Entry

You can enter numbers from the front panel in two ways:

- Use the knob and cursor keys to modify the number. Rotate the knob to change a digit (clockwise increases). The arrows below the knob move the cursor.

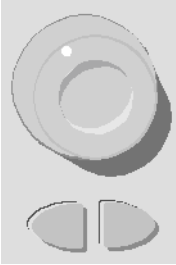

- Use the keypad to enter numbers and the softkeys to select units. The [+/-] key changes the number's sign.





## Operating Information

### Rear Panel at a Glance

The rear panels on the 33500 Series and 33600 Series instruments have similar features, but their locations vary, as shown below.

#### 33500 Series



#### 33600 Series

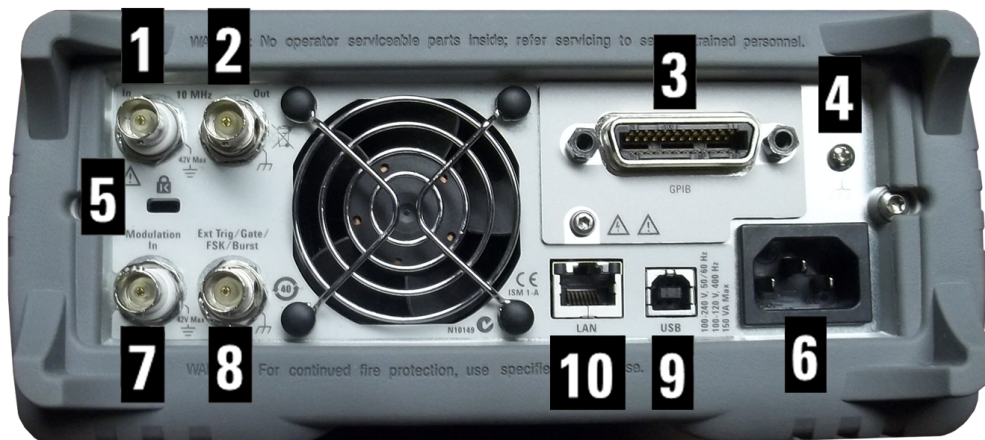

Item	Description
1	External 10 MHz Reference Input
2	Internal 10 MHz Reference Output
3	GPIB Connector
4	Chassis Ground
5	Instrument Cable Lock
6	AC Power

Item	Description
7	External Modulation Input
8	External Trig/Gate/FSK/Burst (Input and Output)
9	USB Interface Connector
10	Local Area Network (LAN) Connector

**WARNING**

The external 10 MHz reference input BNC connector, both the shell and center pin, on the rear panel of the instrument is isolated up to  $\pm 42$  Vpk from chassis. The shell of this BNC connector is isolated from the rest of the instrument. Internal circuitry will attempt to keep the isolated voltage to within  $\pm 42$  Vpk to chassis. Attempts to float this input beyond  $\pm 42$  Vpk from chassis may destroy the instrument and cause a hazard that could result in personal injury or death.

**WARNING**

The external modulation input BNC connector, both the shell and center pin, on the rear panel of the instrument is isolated up to  $\pm 42$  Vpk from chassis. The shell of this BNC connector is connected to the shells of the front panel BNC connectors. Internal circuitry will attempt to keep the isolated voltage to within  $\pm 42$  Vpk to chassis. Attempts to float the outputs beyond  $\pm 42$  Vpk from chassis may destroy the instrument and cause a hazard that could result in personal injury or death.

**WARNING**

This is a Protection Class 1 equipment (chassis must be connected to a protective earth ground). The mains plug shall only be inserted in an outlet provided with a Protective Earth Terminal.

### Quick Start

This section describes basic procedures to help you get started quickly with the instrument.

- [Prepare Instrument for Use](#)
- [Adjust the Carrying Handle](#)
- [Set Output Frequency](#)
- [Set Output Amplitude](#)
- [Set DC Offset Voltage](#)
- [Set High-Level and Low-Level Values](#)
- [Output a DC Voltage](#)
- [Set Duty Cycle of a Square Wave](#)
- [Configure a Pulse Waveform](#)
- [Select a Stored Arbitrary Waveform](#)
- [Use Built-in Help System](#)
- [Rack Mount the Instrument](#)

## Prepare Instrument for Use

Verify that you received the following items. If anything is missing, please contact your nearest Keysight sales office or Keysight authorized reseller.

- Power cord (for country of destination)
- Certificate of Calibration
- USB 2.0 cable

Note: For the latest firmware and documentation, see [www.keysight.com/find/trueform](http://www.keysight.com/find/trueform).

The instrument may be used with mains power of either 100–240 V, 50/60 Hz or 100–120 V, 400 Hz. The maximum power usage is 150 VA. Mains supply voltage fluctuations are not to exceed 10% of the nominal supply voltage. Ensure that you are using the correctly rated mains cord based on the instrument's rating and your country's electrical codes. Connect the power cord and LAN, GPIB, or USB cable as desired. Turn the instrument on by pressing the power switch in the lower left corner of front panel. The instrument runs a power-on self test and then displays a message about how to obtain help, along with the current IP address. It also displays the GPIB address if the GPIB option is installed and enabled.

Power Switch:



The instrument's default function is a 1 kHz, 100 mVpp sine wave (into a 50  $\Omega$  termination). At power-on, the channel output connectors are disabled. To enable output on a channel connector, press the key above the channel connector and then press the **Output Off / On** softkey.

If the instrument does not turn on, verify that the power cord is firmly connected. Also make sure that the instrument is connected to an energized power source. If the LED below the power switch is off, there is no AC power connected. If the LED is amber, the instrument is in standby mode with AC power connected, and if it is green, the instrument is on.

If the power-on self test fails, the display shows **ERR** in the upper right corner. It also prominently displays "**Check for error messages in the error queue.**"

See [SCPI Error Messages](#) for information on error codes. See [Service and Repair - Introduction](#) for instructions on returning the instrument for service.

To turn off the instrument, hold the power switch down for about 500 ms. This prevents you from turning the instrument off by accidentally brushing the power switch.

## Operating Information

### Adjust the Carrying Handle

Grasp the sides of the handle, pull outward, and rotate the handle.

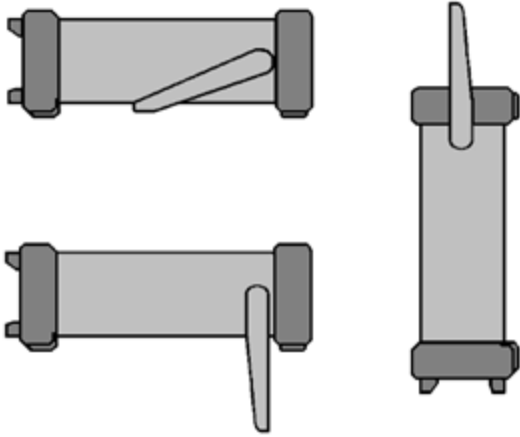

## Set Output Frequency

The default frequency is 1 kHz. You can change the frequency, and you can specify frequency in units of period instead of Hz.

To change frequency with the knob:

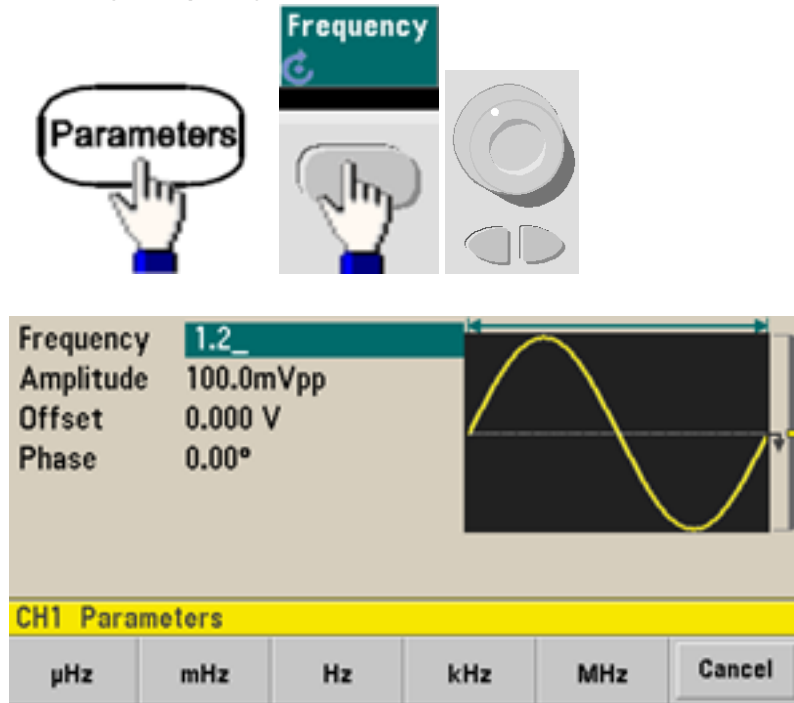

To change frequency with the numeric keypad:



Finish by selecting frequency units:



To change the units to period instead of frequency:

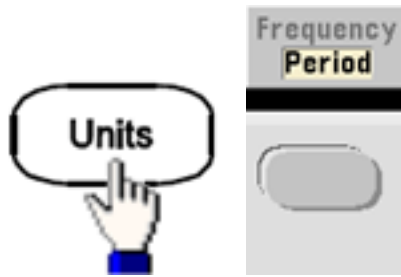

## Set Output Amplitude

The instrument's default function is a 1 kHz, 100 mVpp sine wave (into a 50  $\Omega$  termination).

The following steps change the amplitude to 50 mVpp.

1. Press **[Units]** > **Amp/Offs** or **High/Low** to make sure that you are in **Amp/Offs**.

The displayed amplitude is either the power-on value or the amplitude previously selected. When you change functions, the same amplitude is used if it is valid for the new function. To choose whether you want to specify voltage as amplitude and offset or high and low values, press **[Units]** and then the second softkey. In this case, we will highlight **Amp/Offs**.

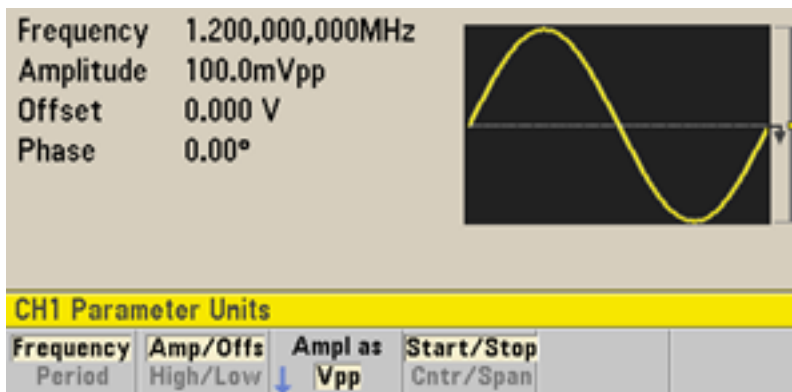

2. Enter the magnitude of the desired amplitude.

Press **[Parameters]** > **Amplitude**. Using the numeric keypad, enter the number 50.

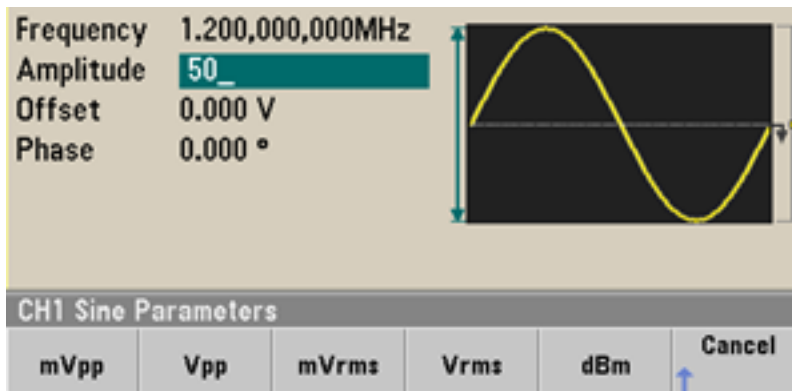



3. **Select the desired units.**

Press the softkey that corresponds to the desired units. When you select the units, the instrument outputs the waveform with the displayed amplitude (if the output is enabled). For this example, press **mVpp**.

You can also enter the desired value using the knob and arrows. If you do so, you do not need to use a units softkey. You can easily convert unit types. Simply press **[Units] > Ampl As** and select the desired units.

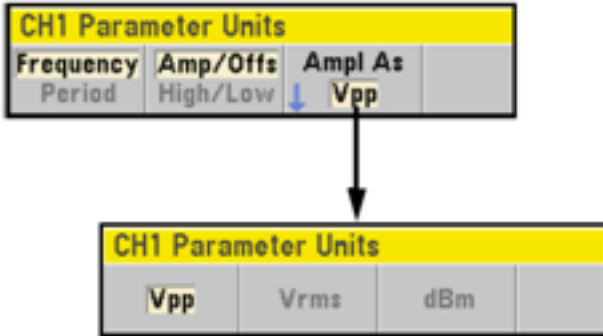

## Set DC Offset Voltage

At power-on, the DC offset is 0 V. The following steps change the offset to -1.5 VDC.

1. Press **[Parameters]** > **Offset**.

The displayed offset voltage is either the power-on value or the offset previously selected. When you change functions, the same offset is used if the present value is valid for the new function.

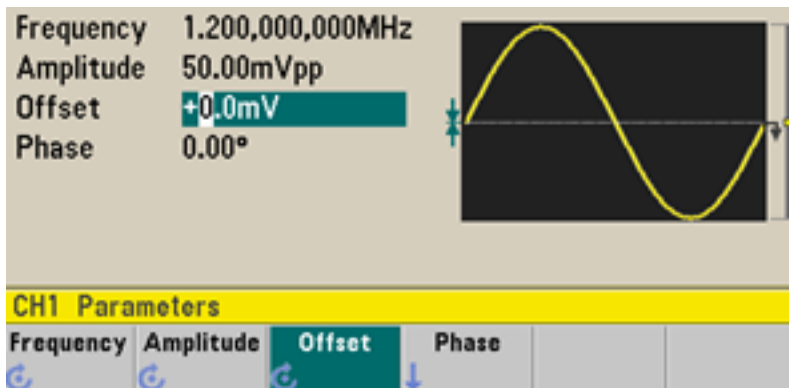

2. Enter the desired offset.

In this case we will use the numeric keypad to enter -1.5.

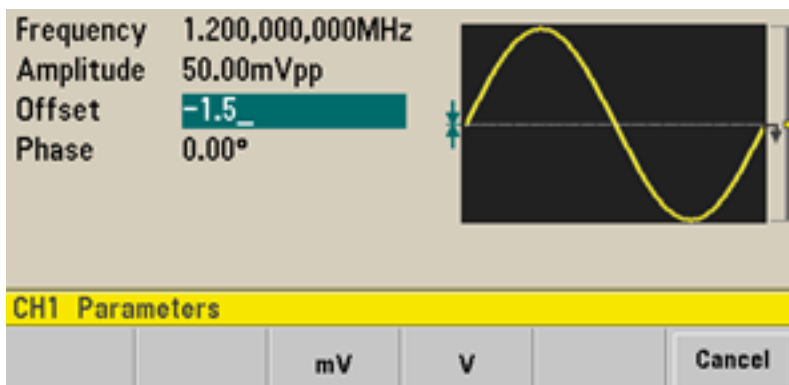

## Operating Information

### 3. Select the desired units.

Press the softkey for the desired units. When you select the units, the instrument outputs the waveform with the displayed offset (if the output is enabled). For this example, press **V**. The voltage will be set as shown below.

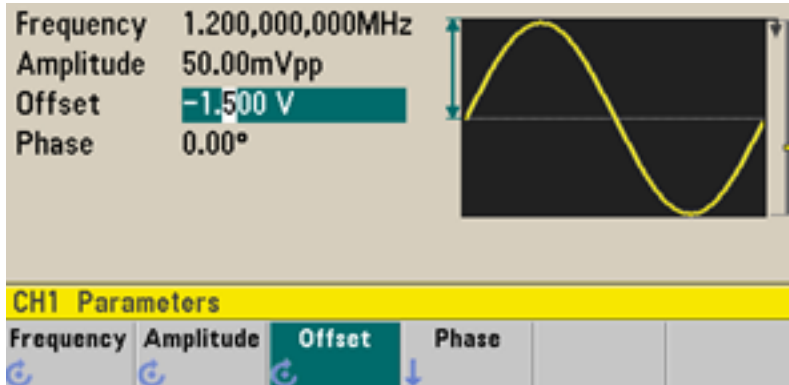

You can also enter the desired value using the knob and arrows.

## Set High-Level and Low-Level Values

You can specify a signal by setting its amplitude and DC offset, described above. You can also specify the signal as high (maximum) and low (minimum) values. This is typically convenient for digital applications. In the following example, we will set the high level to 1.0 V and the low level to 0.0 V.

1. Press **[Units]** > **Ampl/Offs** to toggle to **High/Low** as shown below.

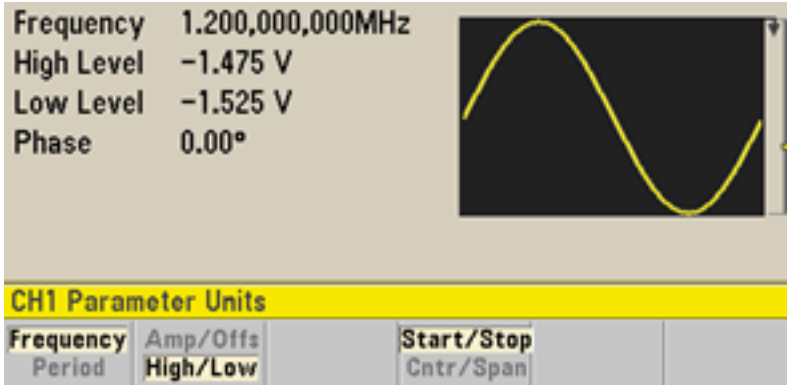

2. Press the **[Parameters]** > **High Level**. Using the numeric keypad or knob and arrows, select a value of 1.0 V. (If you are using the keypad, you will need to select the **V** unit softkey to enter the value.)

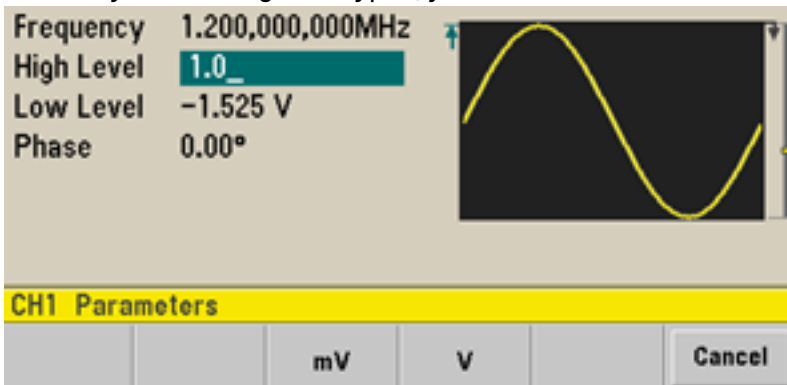

3. Press the **Low Level** softkey and set the value. Again, use the numeric keypad or the knob to enter a value of 0.0 V.

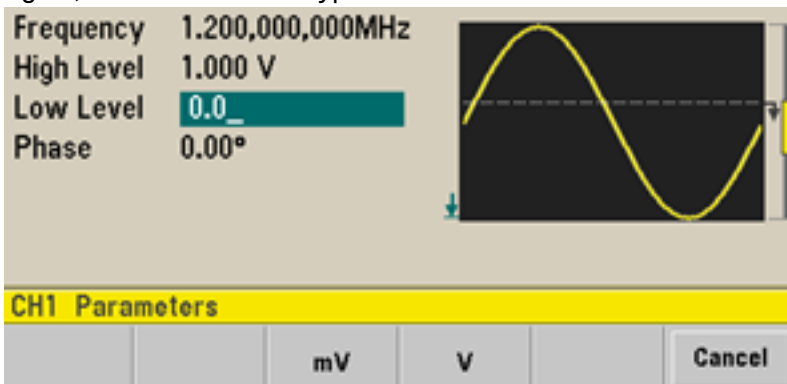

These settings (high-level = 1.0 V and low-level = 0.0 V) are equivalent to setting an amplitude of 1.0 Vpp and an offset of 500 mV.

## Output a DC Voltage

You can output a constant DC voltage, from -5 V to +5 V into 50  $\Omega$ , or -10 V to +10 V into a high impedance load.

1. Press **[Waveforms]** > **More** > **DC**.  
The **Offset** value becomes selected.

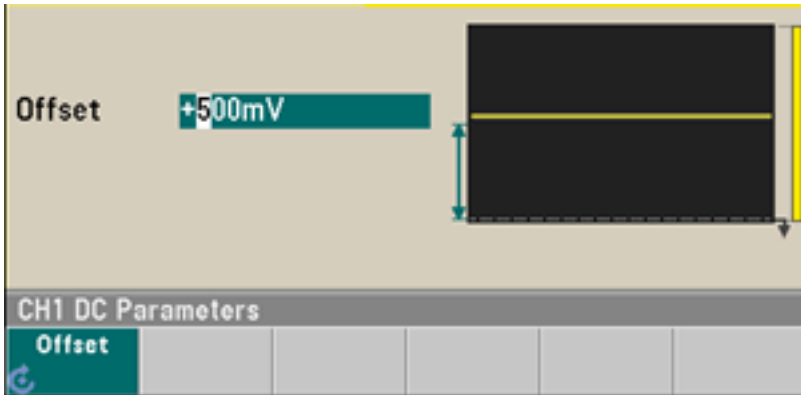

2. Enter the desired voltage offset.  
Enter 1.0 with the numeric keypad or knob, and press the **V** softkey if you used the keypad.

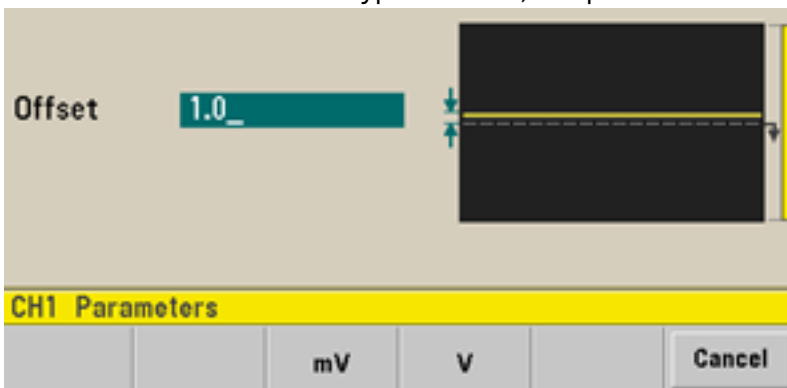

## Set Duty Cycle of a Square Wave

The power-on default for square wave duty cycle is 50%. The duty cycle is limited by the minimum pulse width specification of 16 ns on the 33500 Series, or 5 ns up to 4 Vpp and 8 ns up to 10 Vpp on the 33600 Series. The following procedure changes the duty cycle to 75%.

1. **Select the square wave function.**

Press [Waveforms] > Square.

2. Press the **Duty Cycle** softkey.

The displayed duty cycle is either the power-on value or the percentage previously selected. The duty cycle represents the amount of time per cycle that the square wave is at a high level.

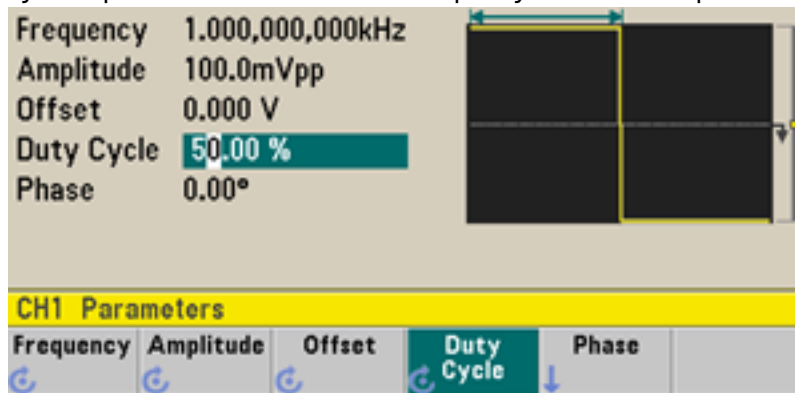

3. **Enter the desired duty cycle.**

Using the numeric keypad or the knob and arrows, select a duty cycle value of 75. If you are using the numeric keypad, press **Percent** to finish the entry. The instrument adjusts the duty cycle immediately and outputs a square wave with the specified value (if the output is enabled).

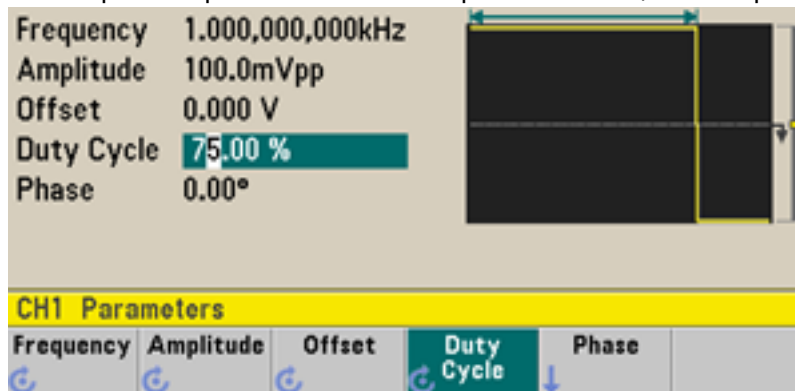

## Configure a Pulse Waveform

You can configure the instrument to output a pulse waveform with variable pulse width and edge time. The following steps configure a 500 ms periodic pulse waveform with a pulse width of 10 ms and edge times of 50 ns.

1. **Select the pulse function.**

Press [Waveforms] > Pulse to select the pulse function.

2. **Set the pulse period.**

Press the [Units] key and then press **Frequency/Period** to choose **Period**. Then press [Parameters] > **Period**. Set the period to 500 ms.

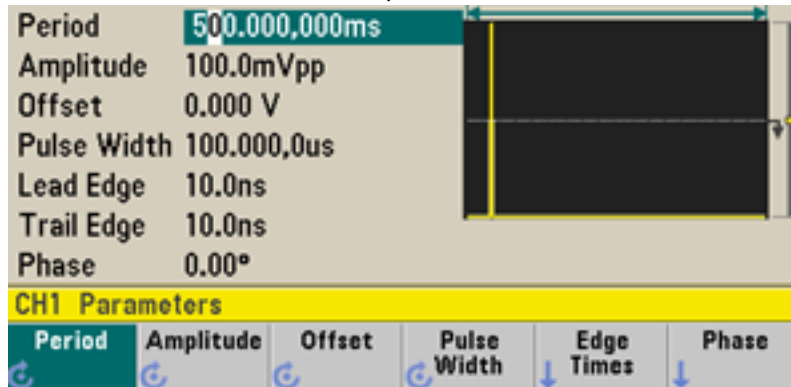

3. **Set the pulse width.**

Press [Parameters] > **Pulse Width**. Then set the pulse width to 10 ms. The pulse width represents the time from the 50% threshold of the rising edge to the 50% threshold of the next falling edge.

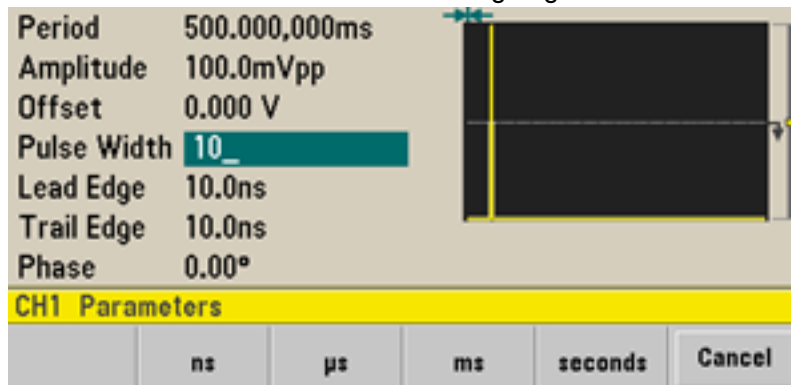

4. **Set the edge time for both edges.**

Press the **Edge Times** softkey and then set the edge time for both the leading and trailing edges to 50 ns. The edge time represents the time from the 10% threshold to the 90% threshold of each edge.

## Select a Stored Arbitrary Waveform

There are nine built-in arbitrary waveforms stored in non-volatile memory. They are Cardiac, D-Lorentz, Exponential Fall, Exponential Rise, Gaussian, Haversine, Lorentz, Negative Ramp, and Sinc.

This procedure selects the built-in "exponential fall" waveform from the front panel. For information on creating a custom arbitrary waveform, refer to [Set Up Arbitrary Waveform](#).

1. Press **[Waveforms]** > **Arb** > **Arbs**.
2. Choose **Select Arb** and use the knob to select **Exp\_Fall**. Press **Select**.

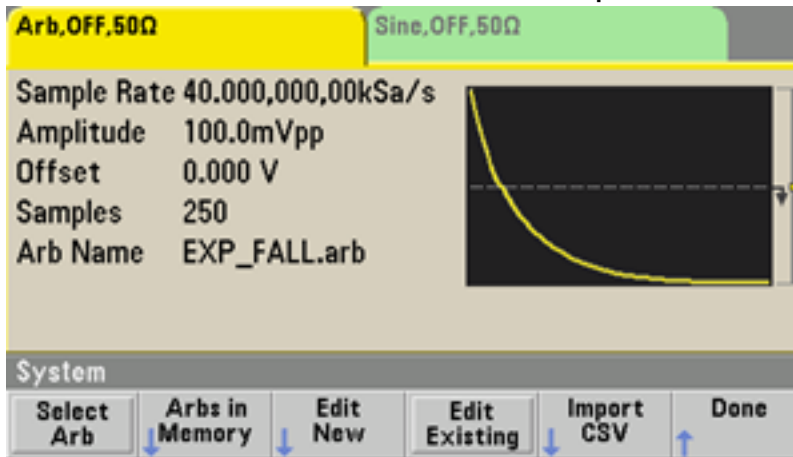



## Use Built-in Help System

The built-in help system provides context-sensitive help on any front panel key or menu softkey. A list of help topics is also available to assist you with several front panel operations.

### View the help information for a function key

Press and hold any softkey or front panel key, such as **[Waveforms]**. If the message contains more information than will fit on the display, press the down arrow softkey or use the knob to view the remaining information.

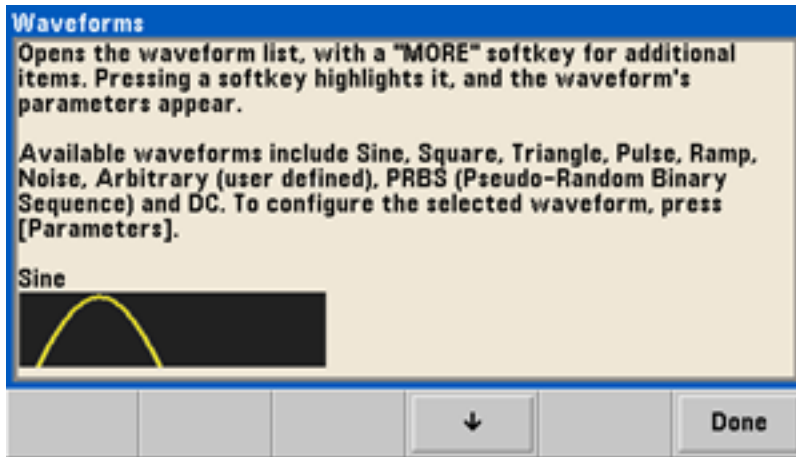

Press **Done** to exit Help.

### View the list of help topics.

Press **[System] > Help** to view the list of available help topics. To scroll through the list, press the up and down arrow softkeys or use the knob. Select the topic **Get HELP on any key** and then press **Select**. Note that the topics may vary from the list shown below, depending on model and firmware version.

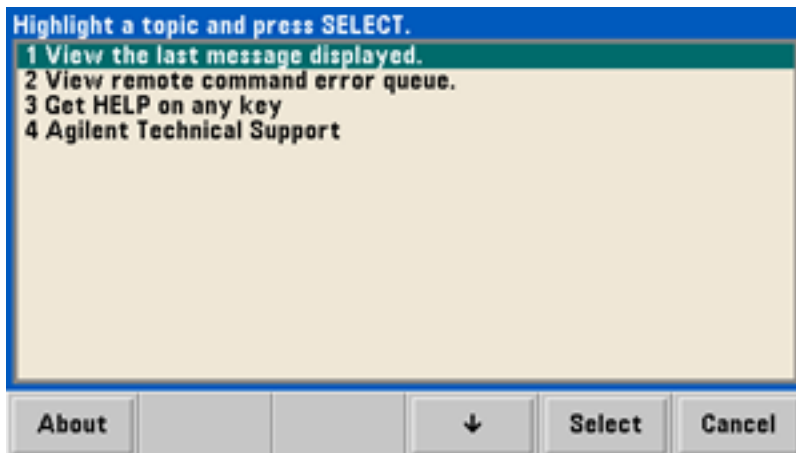

Press **Done** to exit Help.

### View the help information for displayed messages.

Whenever a limit is exceeded or any other invalid configuration is found, the instrument displays a message. The built-in help system provides additional information on the most recent message. Press **[System]** > **Help**. Then select the topic **View the last message displayed**, and press **Select**.

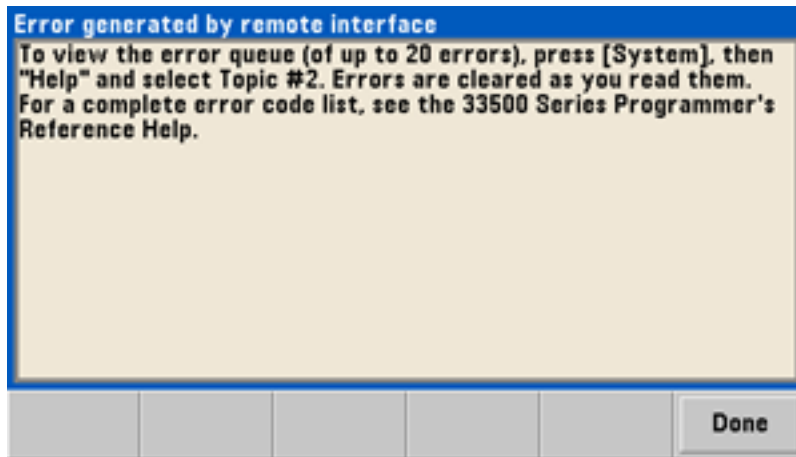

Press **Done** to exit Help.

#### NOTE

#### Local Language Help

All messages, context-sensitive help, and help topics are available in English, Chinese, French, German, Japanese, Korean, and Russian. Softkey labels and status line messages are not translated. To select the language, press **[System]** > **System Setup** > **User Settings** > **Help Lang**. Then select the desired language.

## Rack Mount the Instrument

You can mount the instrument in a standard 19-inch rack cabinet using one of two optional kits, each of which includes instructions and mounting hardware. Any Keysight System II instrument of the same size can be rack-mounted beside the instrument.

**NOTE**

Remove the carrying handle, and the front and rear rubber bumpers, before rack-mounting the instrument.

To remove the handle, rotate it to vertical and pull the ends outward.

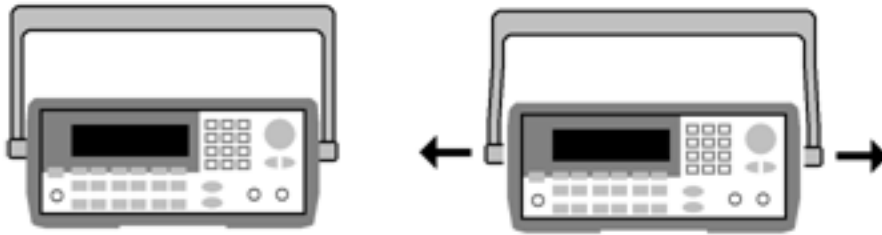

To remove the rubber bumper, stretch a corner and then slide it off.

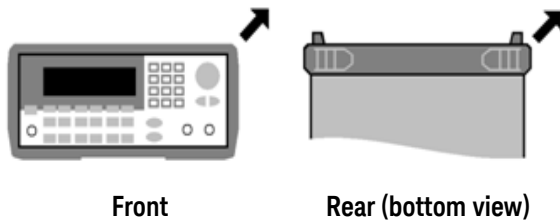

Front

Rear (bottom view)

To rack mount a single instrument, order adapter kit 1CM124A.

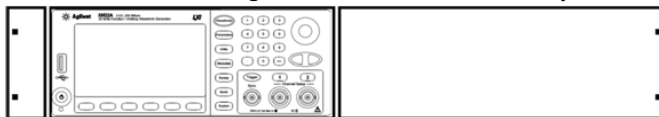

To rack mount two instruments side-by-side, order lock-link kit 34194A and flange kit 1CM107A. Be sure to use the support rails in the rack cabinet.

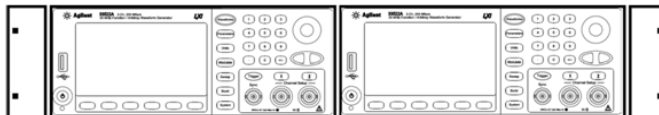

**CAUTION**

To prevent overheating, do not block airflow to or from the instrument. Air enters at the rear of the instrument and exits at both sides and the bottom. Ensure that at least one side is unblocked to allow the ventilation air to exhaust freely. Do not block the fan on the instrument rear panel.

The 33600 Series instrument's fan speed runs at a constant speed up to an ambient temperature of 28 °C and increases when the ambient temperature goes above 28 °C.

The 33600 Series instruments monitor critical internal temperatures and will shut down if limits are exceeded. Failure of ventilation could result in shutdown.

## Front Panel Menu Operation

This section introduces front panel keys and menus. See [Features and Functions](#), [Front Panel Menu Reference](#), [LAN Configuration Procedure](#), and [Set Up an Arbitrary Waveform](#) for additional front panel operation information.

- [Select Output Termination](#)
- [Reset the Instrument](#)
- [Output a Modulated Waveform](#)
- [Output an FSK Waveform](#)
- [Output a PWM Waveform](#)
- [Output a Frequency Sweep](#)
- [Output a Burst Waveform](#)
- [Trigger a Sweep or Burst](#)
- [Store or Retrieve the Instrument State](#)

## Select Output Termination

The instrument has a fixed series output impedance of 50  $\Omega$  to the front panel channel connectors. If the actual load impedance differs from the value specified, the displayed amplitude and offset levels will be incorrect. The load impedance setting is simply a convenience to ensure that the displayed voltage matches the expected load.

1. Press a channel output key to open the channel configuration screen. Note that the current output termination values (both 50  $\Omega$  in this case) appear on the tabs at the top of the screen.
2. Begin specifying the output termination by pressing **Output Load**.

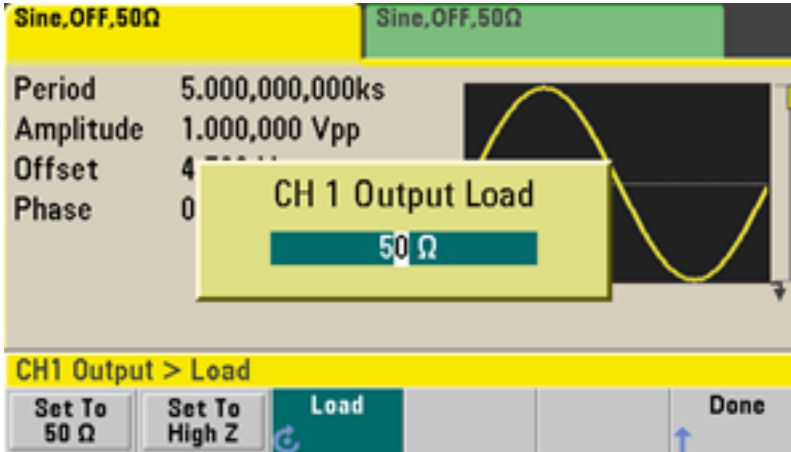

3. Select the desired output termination either by using the knob or numeric keypad to select the desired load impedance or by pressing **Set to 50  $\Omega$**  or **Set to High Z**.

## Reset the Instrument

To reset the instrument to its **factory default state**, press [System] > **Set to Defaults** > **Yes**.

## Output a Modulated Waveform

A modulated waveform consists of a carrier waveform and a modulating waveform. In AM (amplitude modulation), the carrier amplitude is varied by the modulating waveform. For this example, you will output an AM waveform with 80% modulation depth. The carrier will be a 5 kHz sine wave and the modulating waveform will be a 200 Hz sine wave.

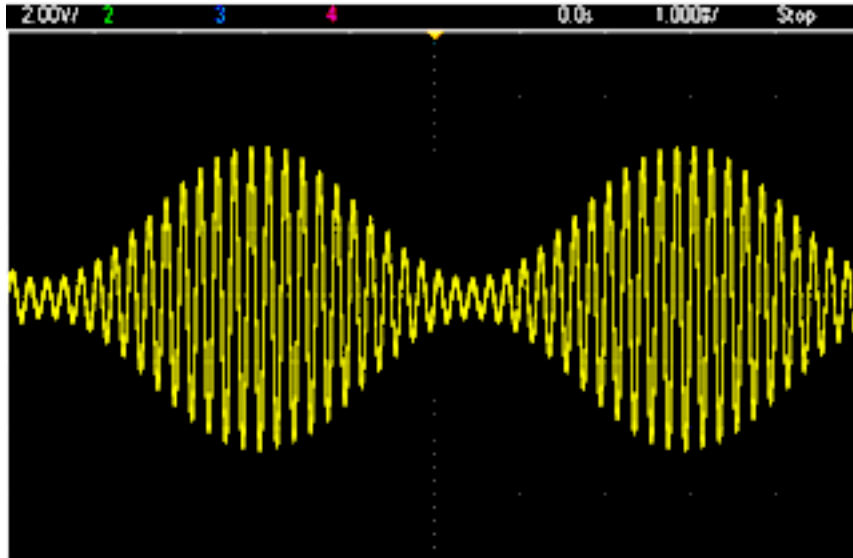

1. **Select the function, frequency, and carrier amplitude.**

Press **[Waveforms]** > **Sine**. Press the **Frequency**, **Amplitude**, and **Offset** softkeys to configure the carrier waveform. For this example, select a 5 kHz sine wave with an amplitude of 5 Vpp, with 0 V offset.

Note that you may specify amplitude in Vpp, Vrms or dBm.

2. **Select AM.**

Press **[Modulate]** and then select **AM** using the **Type** softkey. Then press the **Modulate** softkey to turn modulation on. Notice that the **[Modulate]** key is illuminated, and the status message "AM Modulated by Sine" appears at the top left of the display.

3. **Set the modulation depth.**

Press the **AM Depth** softkey and then set the value to 80% using the numeric keypad or the knob and arrows.

4. **Select the modulating waveform shape.**

Press **Shape** to select the modulating waveform's shape. For this example, select a sine wave.

5. **Press AM Freq.** On the 33500 Series, you will first have to press the **More** softkey to get to the correct menu. Set the value to 200 Hz using the numeric keypad or the knob and arrows. Press **HZ** to finish entering the number if you are using the numeric keypad.

## Output an FSK Waveform

You can configure the instrument to "shift" its output frequency between two preset values (called the "carrier frequency" and the "hop frequency") using **FSK modulation**. The rate at which the output shifts between these two frequencies is determined by the internal rate generator or the signal level on the rear-panel **Ext Trig** connector. For this example, you will set the "carrier" frequency to 5 kHz and the "hop" frequency to 500 Hz, with an FSK rate of 100 Hz.

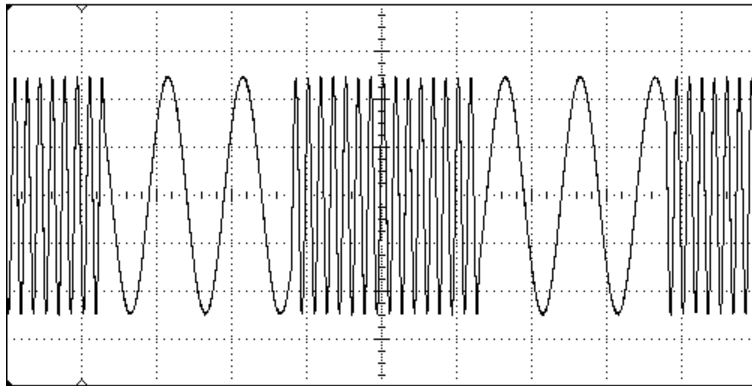

1. **Select the function, frequency, and carrier amplitude.**

Press **[Waveforms]** > **Sine**. Press the **Frequency**, **Amplitude**, and **Offset** softkeys to configure the carrier waveform. For this example, select a 5 kHz sine wave with an amplitude of 5 Vpp, with 0 V offset.

2. **Select FSK.**

Press **[Modulate]** and then select FSK using the **Type** softkey. Then press the **Modulate** softkey to turn modulation on. Notice the status message "FSK Modulated" at the top left of the display.

3. **Set the "hop" frequency.**

Press the **Hop Freq** softkey and then set the value to 500 Hz using the numeric keypad or the knob and arrows. If you use the numeric keypad, be sure to finish the entry by pressing **Hz**.



4. **Set the FSK "shift" rate.**

Press the **FSK Rate** softkey and then set the value to 100 Hz using the numeric keypad or the knob and arrows.



At this point, the instrument outputs an FSK waveform if the channel output is enabled.

## Output a PWM Waveform

You can configure the instrument to output a pulse width modulated (PWM) waveform. PWM is only available for the Pulse waveform, and the pulse width varies according to the modulating signal. The amount by which the pulse width varies is called the width deviation, and it can be specified as a percentage of the waveform period (that is, duty cycle) or in units of time. For example, if you specify a pulse with 20% duty cycle and then enable PWM with a 5% deviation, the duty cycle varies from 15% to 25% under control of the modulating signal.

To change from pulse width to pulse duty cycle, press **[Units]**.

For this example, you will specify a pulse width and pulse width deviation for a 1 kHz pulse waveform with a 5-Hz sine wave modulating waveform.

### 1. Select the carrier waveform parameters.

Press **[Waveforms]** > **Pulse**. Use the **Frequency**, **Amplitude**, **Offset**, **Pulse Width** and **Edge Times** softkeys to configure the carrier waveform. For this example, select a 1 kHz pulse waveform with an amplitude of 1 Vpp, zero offset, a pulse width of 100  $\mu$ s, and an edge time of 50 ns (both leading and trailing).



### 2. Select PWM.

Press **[Modulate]** > **Type** > **PWM**. Then press the first softkey (**Modulate**) to turn modulation on. Notice the status message "PWM Modulated by Sine" in the upper-left corner of the display.

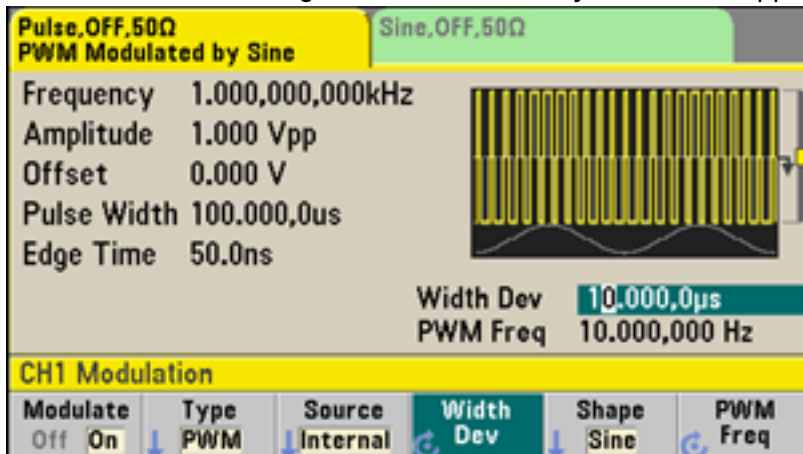



3. **Set the width deviation.**

Press the **Width Dev** softkey and set the value to 20  $\mu$ s using the numeric keypad or the knob and arrows.



4. **Set the modulating frequency.**

Press the **PWM Freq** softkey and then set the value to 5 Hz using the numeric keypad or the knob and arrows.



5. **Select the modulating waveform shape.**

Press **Shape** to select the modulating waveform's shape. For this example, select a sine wave.

To view the actual PWM waveform, you would need to output it to an oscilloscope. If you do this, you will see how the pulse width varies, in this case, from 80 to 120  $\mu$ s. At a modulation frequency of 5 Hz, the deviation is easily visible.

## Output a Frequency Sweep

In the frequency sweep mode, the instrument moves from the start frequency to the stop frequency at a sweep rate, which you specify. You can sweep up or down in frequency, and with either linear or logarithmic spacing, or using a list of frequencies. For this example, you will output a swept sine wave from 50 Hz to 5 kHz.

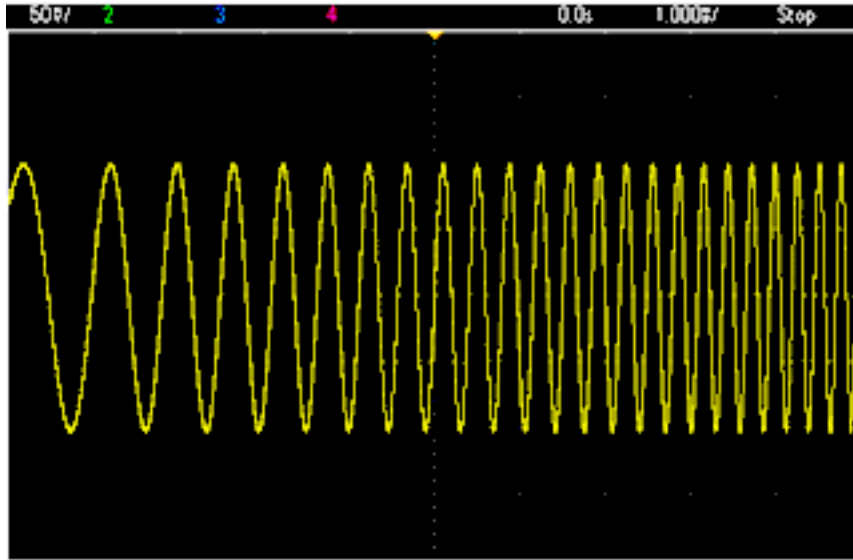

### 1. Select the function and amplitude for the sweep.

For sweeps, you can select sine, square, ramp, pulse, triangle, PRBS waveforms, or arbitrary waveforms (noise and DC are not allowed). For this example, select a sine wave with an amplitude of 5 Vpp.

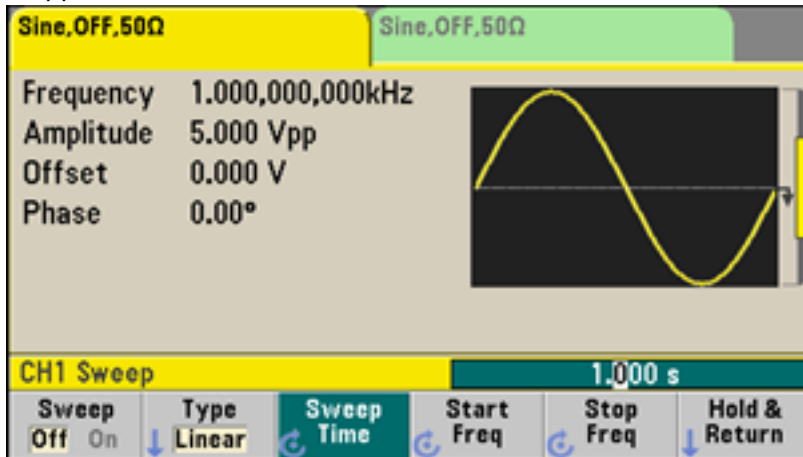

### 2. Select the sweep mode.

Press **[Sweep]** and verify that the linear sweep mode is currently selected on the second softkey. Press the **Sweep** softkey to turn sweep on. Notice the **Linear Sweep** status message at the top of the tab for the current channel. The button is also illuminated.

3. Set the start frequency.

Press **Start Freq** and then set the value to 50 Hz using the numeric keypad or the knob and arrows.



4. Set the stop frequency.

Press **Stop Freq** and set the value to 5 kHz using the numeric keypad or the knob and arrows.

At this point, the instrument outputs a continuous sweep from 50 Hz to 5 kHz if output is enabled.

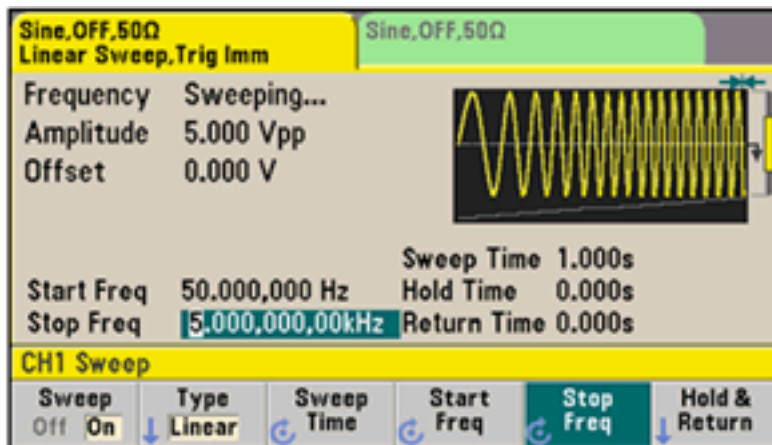

You can also set the sweep frequency boundaries of the sweep using a center frequency and frequency span. These parameters are similar to the start frequency and stop frequency (above) and they provide added flexibility. To achieve the same results, set the center frequency to 2.525 kHz and the frequency span to 4.950 kHz.



To generate a frequency sweep, press **[Trigger]** twice. The first press puts the trigger in manual mode, and the second one sends a trigger. For more information, see [Trigger Sweep or Burst](#).

## Output a Burst Waveform

You can configure the instrument to output a waveform for a specified number of cycles, called a burst. You can control the amount of time that elapses between bursts with the internal timer or the signal level on the rear-panel **Ext Trig** connector. For this example, you will output a three-cycle sine wave with a 20 ms burst period.

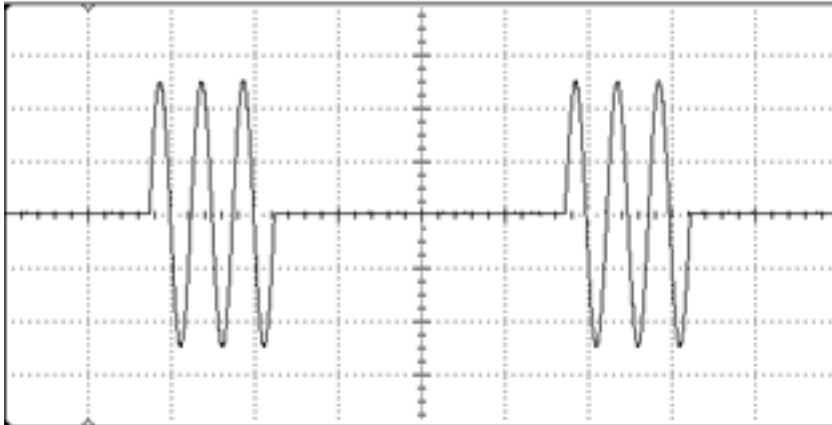

### 1. Select the function and amplitude for the burst.

For burst waveforms, you can select sine, square, ramp, pulse, arbitrary waveforms, triangle, or PRBS. Noise is allowed only in the "gated" burst mode and DC is not allowed. For this example, select a sine wave with an amplitude of 5 Vpp.

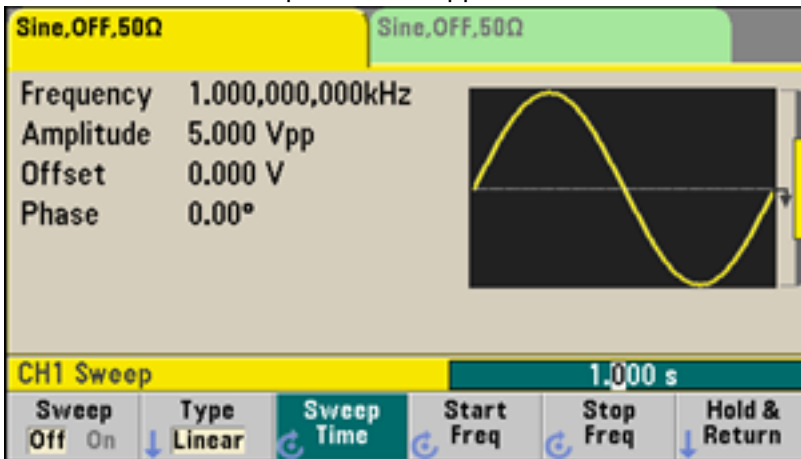

2. **Select the burst mode.**

Press **[Burst]** > **Burst Off/On**. Notice that a status message **N Cycle Burst, Trig Imm** is shown in the tab of the current channel.

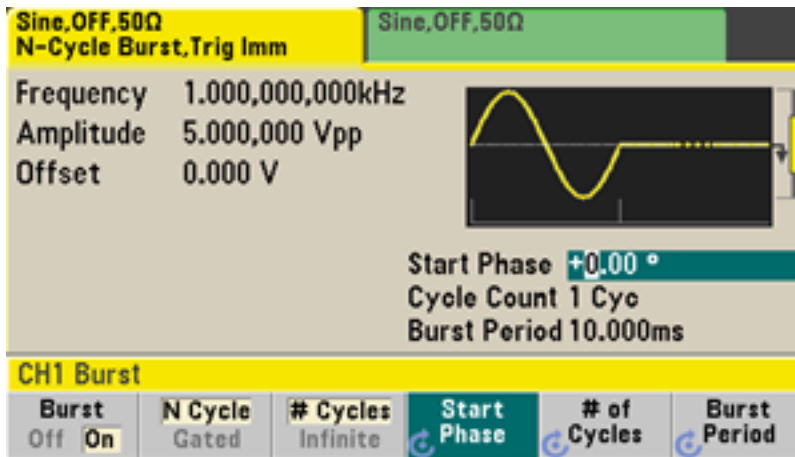

3. **Set the burst count.**

Press **# of Cycles** and set the count to "3" using the numeric keypad or knob. Press **Enter** to finish data entry if you are using the numeric keypad.

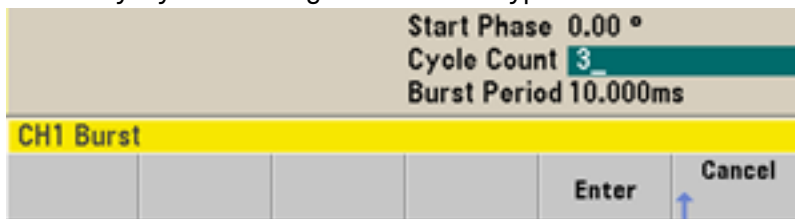

4. **Set the burst period.**

Press **Burst Period** and set the period to 20 ms using the numeric keypad or the knob and arrows. The burst period sets the time from the start of one burst to the start of the next burst. At this point, the instrument outputs a continuous three-cycle burst at 20 ms intervals.

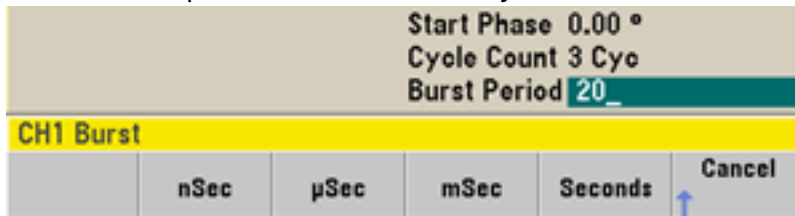

You can generate a single burst (with the specified count) by pressing the **[Trigger]** key. For more information, see [Trigger Sweep or Burst](#).

You can also use the external gate signal to create gated bursts, where a burst is produced while a gate signal is present on the input.

## Trigger a Sweep or Burst

You can select one of four different types of triggers from the front panel for sweeps and bursts:

- Immediate or "automatic" (default): instrument outputs continuously when sweep or burst mode is selected.
- External: triggering controlled by rear panel **Ext Trig** connector.
- Manual: initiates one sweep or burst each time you press **[Trigger]**. Continue pressing **[Trigger]** to re-trigger instrument.
- Timer: issues one or more triggers a fixed time amount apart.

If sweep or burst is on, pressing **[Trigger]** displays the trigger menu. An illuminated **[Trigger]** key (solid or blinking) indicates that one or both channels are awaiting a manual trigger. Solid illumination occurs when the trigger menu is selected, and flashing illumination occurs when the trigger menu is not selected. The **[Trigger]** key is disabled when the instrument is in remote.

Pressing **[Trigger]** when it is solidly illuminated causes a manual trigger. Pressing **[Trigger]** when it is flashing selects the trigger menu; a second press causes a manual trigger.

## Store or Retrieve the Instrument State

You can store instrument states in any number of state files, (extension .sta). You can do this for backup purposes, or you can save your state to a USB drive and load it on another instrument to have instruments with matching configurations. A stored state contains the selected function, frequency, amplitude, DC offset, duty cycle, symmetry, and any modulation or burst parameters in use. The instrument does not store volatile arbitrary waveforms.

1. Select the desired storage location.

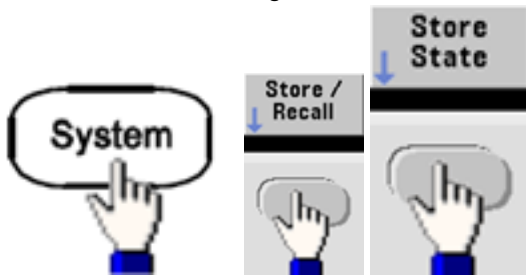

2. Press **Name** and specify the name for the selected location.



### 33500 Series

To add characters, press the right-cursor key until the cursor is to the right of the existing name and then turn the knob. To delete a character, rotate the knob until you get to the blank character before the capital A. To delete all characters from the cursor position to the end of the line, press [+/-]. You can enter numbers directly from the numeric keypad.

### 33600 Series

Use the front panel right and left arrows (under the knob) to select the characters to edit. You can go past the final character to add a new character to the end. Then use the knob to select the desired character and use the arrows to move to the next character to edit.

You can delete one or more characters with the **Delete Char** and **Clear Entry** softkeys.

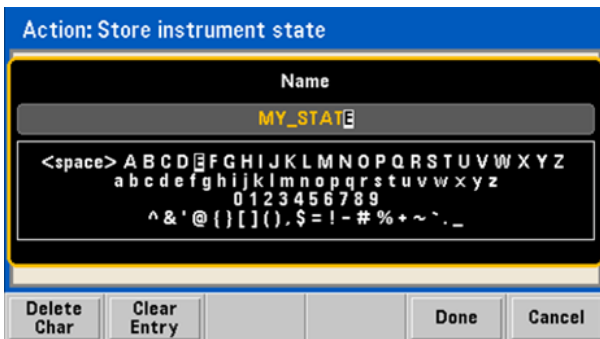

Press **Done** when you have finished entering the name.

3. Store the instrument state.





To restore (retrieve) a stored state:

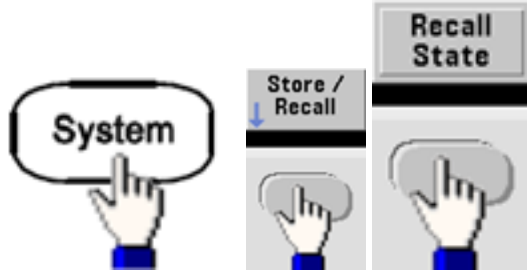

## Front Panel Menu Reference

This chapter begins with an overview of the front panel menus. The remainder of this chapter contains examples of using the front panel menus.

---



### Selects waveform

- Sine
  - Square
  - Ramp
  - Pulse
  - Arbitrary
  - Triangle
  - Noise
  - PRBS
  - DC
- 



**Configures waveform-specific parameters**

- Period/Frequency
  - Amplitude or High and Low Voltage
  - Offset
  - Phase
  - Duty Cycle
  - Symmetry
  - Pulse Width
  - Edge Times
  - Arbitrary Waveform
  - Sample Rate
  - Filter
  - Arb Phase
  - Bandwidth
  - PRBS Data
  - Bit Rate
- 

**Specifies unit and parameter preferences**

- Arb Rate: Sa/s, Freq or Period
  - Voltage as Amplitude/Offset or High/Low
  - Voltage units as Vpp, Vrms, or dBm
  - Pulse Width or Duty Cycle
  - Burst Phase as Degrees, Radians, or Seconds
  - Arb Phase as Degrees, Radians, Seconds, or Samples
  - Frequency sweep as Center/Span or Start/Stop
-



**Configures modulation parameters**

- Modulation on or off
  - Modulation type: AM, FM, PM, PWM, BPSK, FSK, or Sum
  - Modulation source
  - Modulation parameters (vary by modulation type)
- 



**Configures frequency sweep parameters**

- Sweep on or off
  - Sweep type: Linear, logarithmic or frequency list
  - Sweep time
  - Start/stop frequencies or center/span frequencies
  - Dwell, hold, and return times
- 



**Configures burst parameters**

- Burst on or off
  - Burst mode: triggered (N Cycle) or externally-gated
  - Cycles per burst (1 to 100,000,000 or infinite)
  - Starting phase angle of burst ( $-360^\circ$  to  $+360^\circ$ )
  - Burst period
-

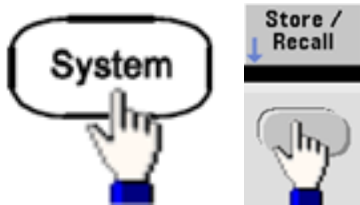

#### Stores and recalls instrument states

- Store instrument states in non-volatile memory.
  - Assign custom names to storage locations.
  - Recall stored instrument states.
  - Delete stored instrument states.
  - Select the instrument's power-on configuration (last power-down or **factory default**).
- 

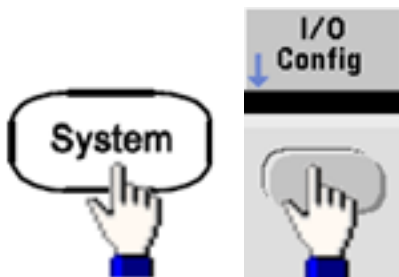

#### Configures instrument I/O interfaces

- Turn LAN on and off
  - Configure LAN (IP address and network configuration)
  - Reset the LAN
  - Specify USB settings
  - Select GPIB address
-

## Operating Information

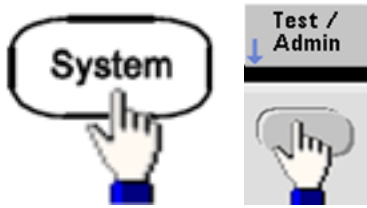

### Performs system administration tasks

- Perform self-test
  - Calibrate instrument
  - Clear instrument memory (NISPOM secure)
  - Install licensed features
  - Update firmware
- 

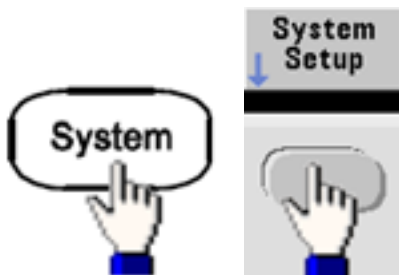

### Configures system-related parameters

- Set screen layout
  - Select local language for front panel messages and help text
  - Select how periods and commas are used in numbers on display
  - Turn display on and off
  - Enable or disable error beeper
  - Enable or disable keypad click
  - Enable or disable screen saver
  - Adjust display brightness
  - Set date and time
  - Manage files and folders (copy, rename, delete, screen capture, and so on)
  - Configure 10 MHz reference oscillator
-

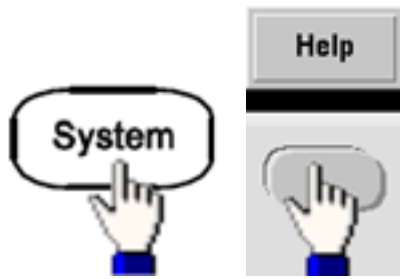

**Shows list of Help topics**

- View last message displayed
  - View remote command error queue
  - Get help on any key
  - Learn how to obtain technical support
  - View "about" data - serial number, IP address, firmware version, and so on
- 



**Enables and configures channels**

- Turn channel on and off
  - Specify which channel is the focus of the menus
  - Select output termination (1  $\Omega$  to 10 k $\Omega$ , or Infinite)
  - Enable / disable amplitude autoranging
  - Select waveform polarity (normal or inverted)
  - Specify voltage limits
  - Specify whether output is normal or gated
  - Configure dual channel operation (coupling, tracking, and combine)
-



**Configures trigger settings and sync output signal**

- Perform a manual trigger, when illuminated
- Specify the trigger source for sweep, burst or arbitrary waveform advance
- Specify the trigger voltage level, count, and delay
- Specify the slope (rising or falling edge) for an external trigger source
- Specify the slope (rising or falling edge) of the trigger output signal
- Enable / disable the signal output from the "Sync" connector
- Specify the Sync source, polarity, mode, marker point, and so on

## LAN Configuration Procedure

There are several parameters that you might need to set to establish network communication using the LAN interface. Primarily, you will need to establish an IP address. You might need to contact your network administrator for help in establishing communication with the LAN interface.

1. **Select the "I/O" menu.**  
Press [System] > I/O Config.

## 2. Select the LAN Settings menu.

Press the **LAN Settings** softkey.

You can select **Modify Settings** to change the LAN settings, or you can turn LAN Services on and off or restore the LAN settings to default values.



### NOTE

This screen reflects the 33500 Series display. The 33600 Series also includes a LAN Status indicator in the upper right corner to indicate whether the LAN connection is good or faulty.

## 3. Press **Modify Settings**.



To access most items on this screen, use the first softkey to switch from **DHCP** to **Manual**. With DHCP on, an IP address will automatically be set by DHCP (Dynamic Host Configuration Protocol) when you connect the instrument to the network, provided the DHCP server is found and is able to do so. DHCP also automatically deals with the subnet mask and gateway address, if required. This is typically the easiest way to establish LAN communication for your instrument. All you need to do is leave DHCP on. Contact your LAN administrator for details.



4. **Establish an "IP Setup."**

If you are not using DHCP (if the first softkey is set to **Manual**), you must establish an IP setup, including an IP address, and possibly a subnet mask and gateway address. The **IP Address** and **Subnet Mask** buttons are on the main screen, and you press **More** to configure the Gateway.

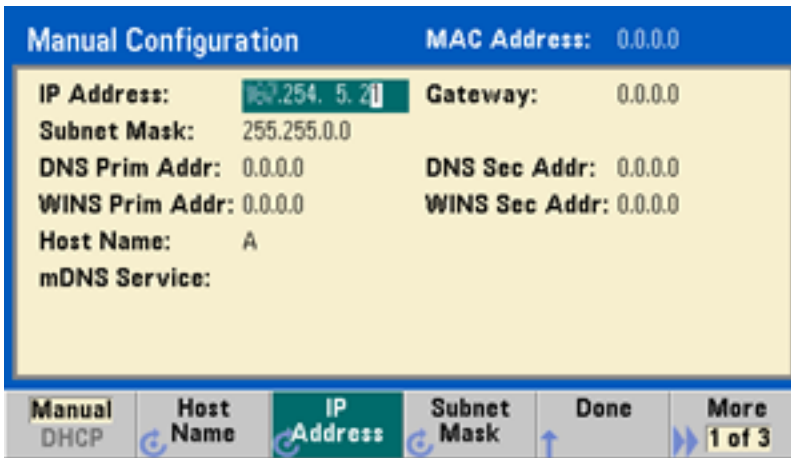

Contact your network administrator for the IP address, subnet mask, and gateway to use. All IP addresses take the dot-notation form "nnn.nnn.nnn.nnn" where "nnn" in each case is a byte value in the range 0 through 255. You can enter a new IP address using the numeric keypad (not the knob). Just type in the numbers and the period delimiters using the keypad. Use the left cursor key as a backspace key. **Do not enter leading zeros.**

5. **Configure the "DNS Setup" (optional)**

DNS (Domain Name Service) is an Internet service that translates domain names into IP addresses. Ask your network administrator whether DNS is in use, and if it is, for the host name, domain name, and DNS server address to use.

- a. Set the "hostname." Press **Host Name** and enter the hostname. A hostname is the host portion of the domain name, which is translated into an IP address. The hostname is entered as a string using the knob and cursor keys to select and change characters. The hostname may include letters, numbers, and dashes ("-"). You can use the keypad for the numeric characters only.

- b. Set the "DNS Server" addresses. From the LAN configuration screen, press **More** to go to the second of three sets of softkeys.

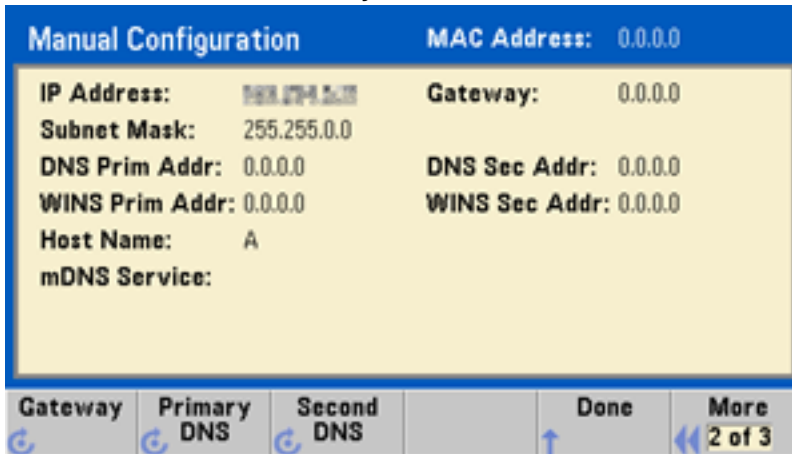

Enter the Primary DNS and Second DNS. See your network administrator for details.

### More about IP Addresses and Dot Notation

Dot-notation addresses ("nnn.nnn.nnn.nnn" where "nnn" is a byte value from 0 to 255) must be expressed with care, as most PC web software interprets byte values with leading zeros as octal (base 8) numbers. For example, "192.168.020.011" is actually equivalent to decimal "192.168.16.9" because ".020" is interpreted as "16" expressed in octal, and ".011" as "9". To avoid confusion, use only decimal values from 0 to 255, with no leading zeros.

### Set Up an Arbitrary Waveform

The instrument includes an embedded waveform editor that allows you to create and edit arbitrary waveforms. You can create these waveforms by editing voltage values directly or by using a combination of up to 12 different kinds of standard waveforms.

The following tutorial creates and edits a basic waveform.

### Insert Built-in Waveforms

1. Start the embedded waveform editor by pressing **[Waveforms]** > **Arb** > **Arbs**. Press **Edit New**, accept the default file name, and then **Start Editor**. You now have a 0 VDC waveform of exactly 8 points (33500 Series) or 32 points (33600 Series).

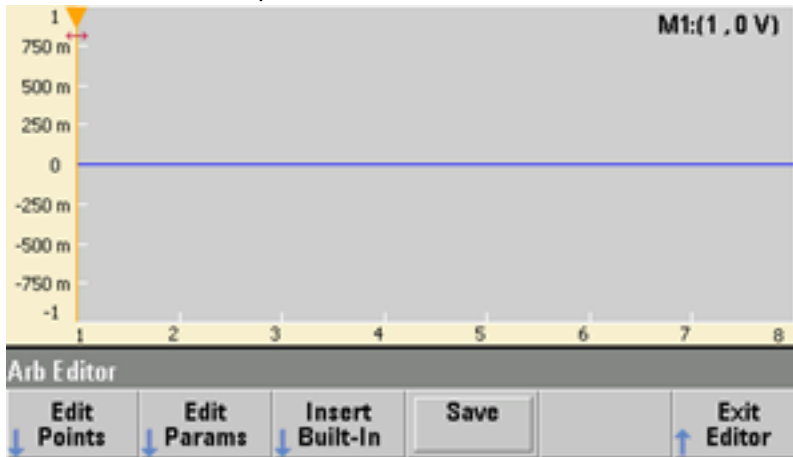

**NOTE**

The rest of this tutorial is based on the embedded waveform editor in a 33500 Series instrument, which has a minimum waveform size of 8 points. If you are using this tutorial on a 33600 Series instrument, please note that the minimum waveform size for the embedded waveform editor is 32 points.

2. Press **Insert Built-in** > **Choose Wave**. Use the knob or the arrows below the knob to select **D-Lorentz** and press **OK**. Use the keypad and the **V** softkey that appears when you start typing on the keypad to set the **Amplitude** to 2 V, and then press **OK**. The waveform now has 100 additional points, as the D-Lorentz waveform of 100 points was inserted in front of the initial waveform.



- Suppose that you want to undo the change that you just made. Press **[System]** > **Undo**. You are now back to the original 0 V waveform.

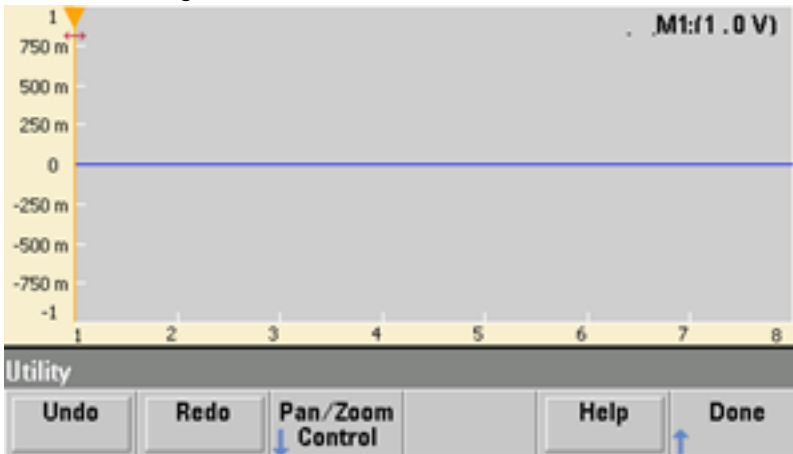

- To put the D-Lorentz waveform back, press **Redo**. Then press **Done** to exit.

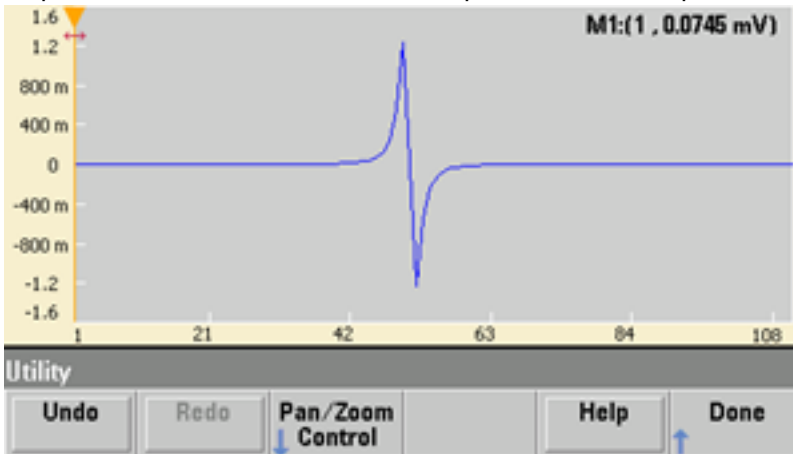

- Now we will insert a sine wave. Begin by pressing **Choose Wave**. Make sure Sine (the default) is highlighted, and press **OK**. For help in understanding the various parameters on the screen, press **Parameter Help**. Then press **Done** to exit the help screen.

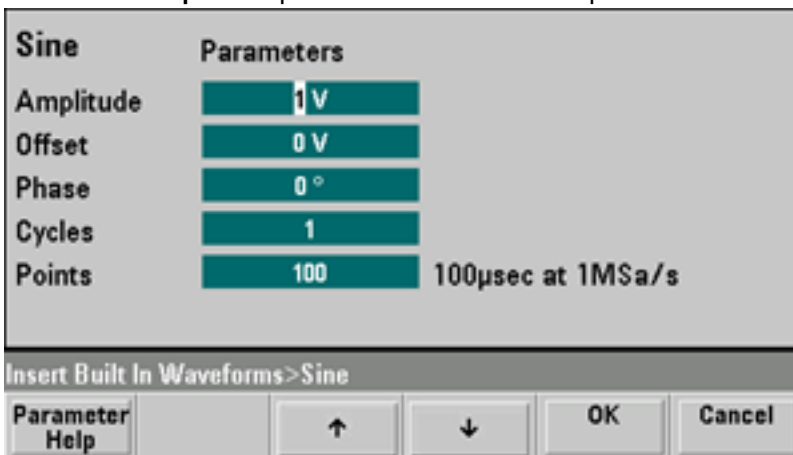

## Operating Information

- Using the numeric keypad and the up and down arrow softkeys, set the **Amplitude** to 3.5 V, the **Cycles** to 4, and the **Points** to 200. Leave all other settings at their default values and press **OK**.

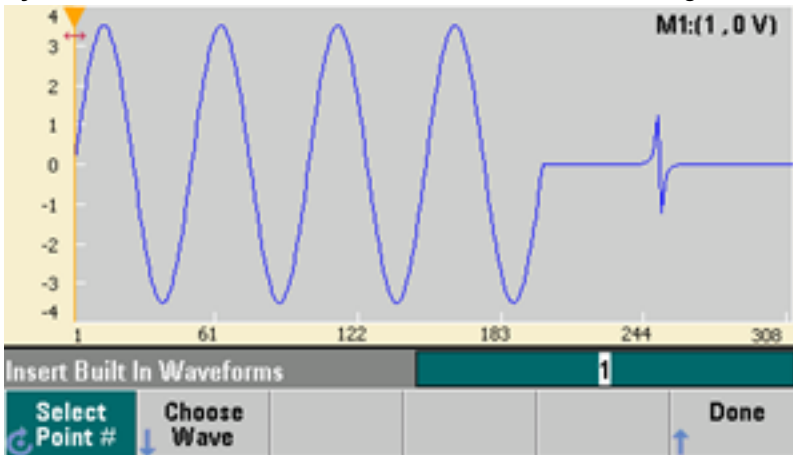

- Notice that the first softkey, **Select Point #** is highlighted. Put the marker on the 270th waveform point by using the numeric keypad to enter the number 270 and pressing **Enter**.

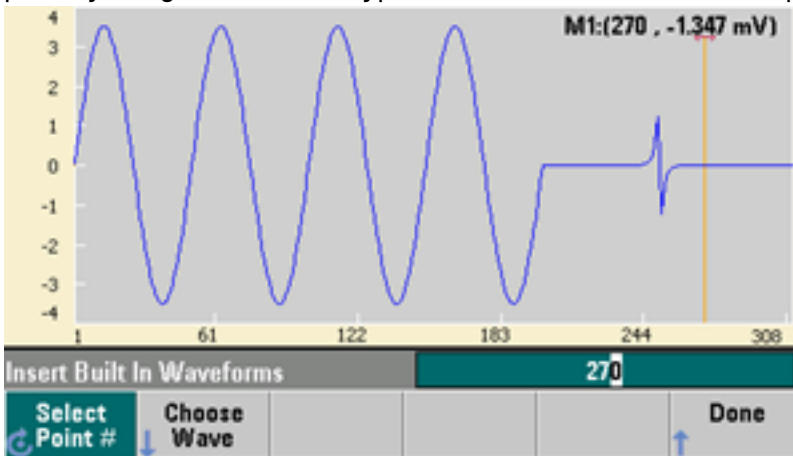

- Press **Choose Wave**, select **Square**, and then press **OK**. Set the Amplitude to 3 V, the Offset to -2 V, the Cycles to 8, and the Points to 100. Press **OK**. Notice that the 8 square wave cycles have been inserted, beginning at the marker. Press **Done**.

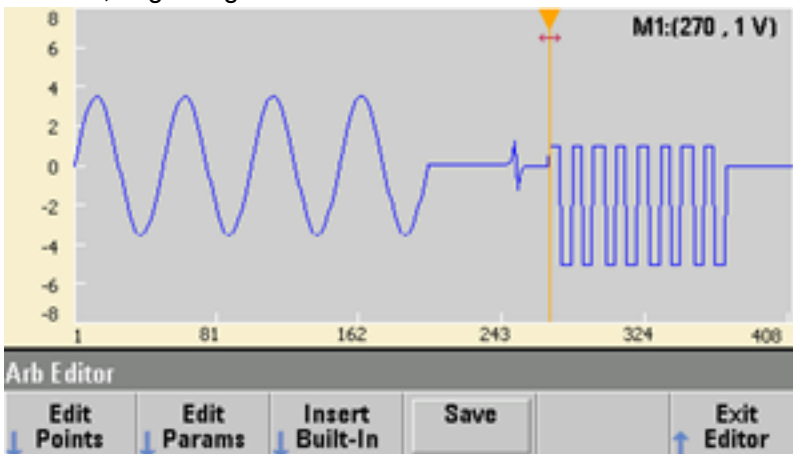

### Edit Waveform Characteristics

1. Press **Edit Params** and then set the **Sampling Rate** to 100 Sa/s. Press **Cycle Period** and notice that it has been set to 4.08 seconds. This is because you have 408 sample points in the waveform, and the sample rate is 100 Sa/s.

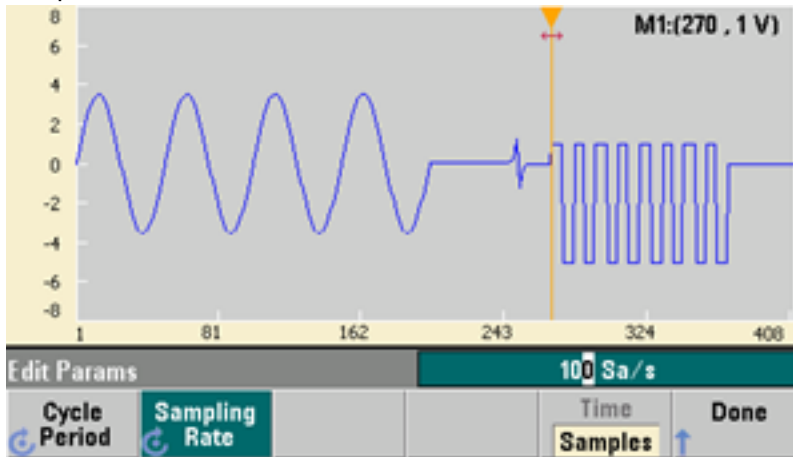

2. Change the **Cycle Period** to 2.04 seconds and then press **Sampling Rate**. It will now be set to 200 Sa/s in order to play the 408 point waveform in 2.04 seconds.

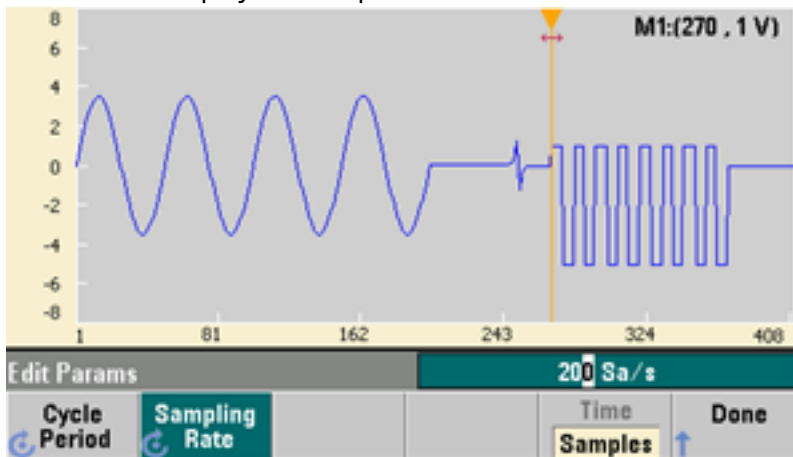

3. Press **Done** to exit the parameter editing screen. Press **Edit Points** and notice that the **Point #** softkey is highlighted. Enter the number 160 and press **Enter** to move the marker.



## Operating Information

4. Press **Voltage** and change the voltage of the selected point to 4.2 V. Press **Point #** and change the point marker to 150 to move the marker off the point. When you press **Enter** to finish entering point 150, you will see the 4.2 V anomaly in the wave that you just created at point 160.



## Zoom and Pan

1. To see the point in detail, press **[System]** > **Pan/Zoom Control**. Notice that the first softkey is set to **Horizontal**, meaning that the zooming that we are about to do will be along the horizontal (time) axis. Change the **Zoom** to 500%, and the sine wave anomaly will be more obvious.

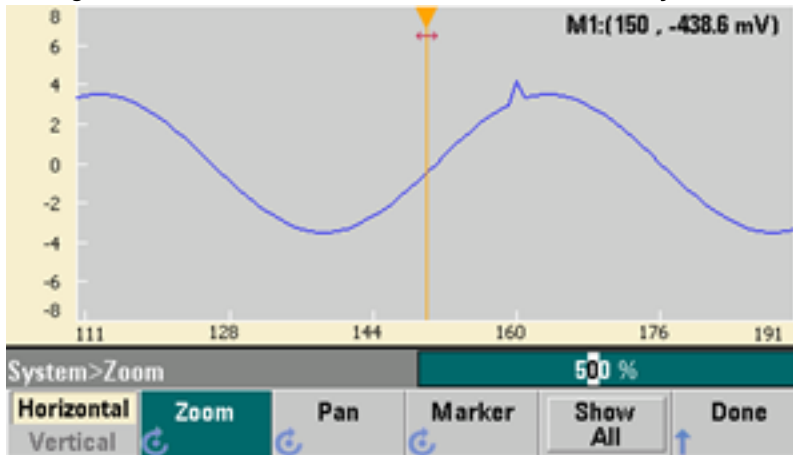

2. Now set the first softkey to **Vertical** to zoom vertically. Set the **Zoom** to 500%. Notice that we have zoomed in on the voltage axis, but we are too low to see the 4.2 V anomaly in the sine wave.

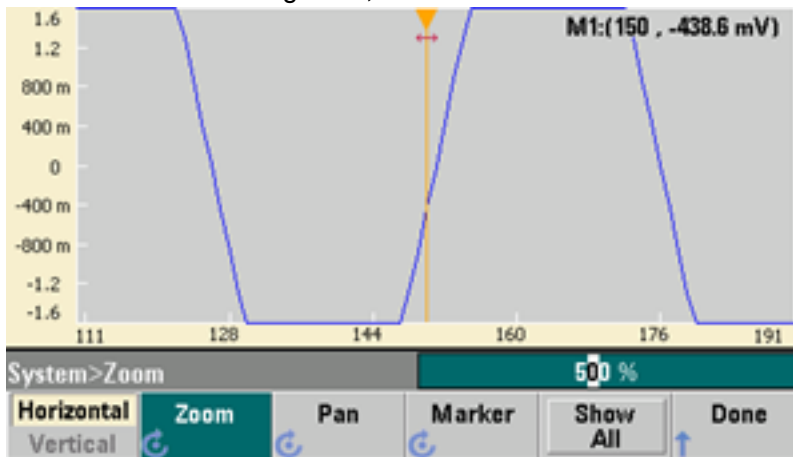

3. Press **Pan** and set the **Pan** to 3 V in order to move higher on the waveform. The 4.2 V point is now clearly visible.

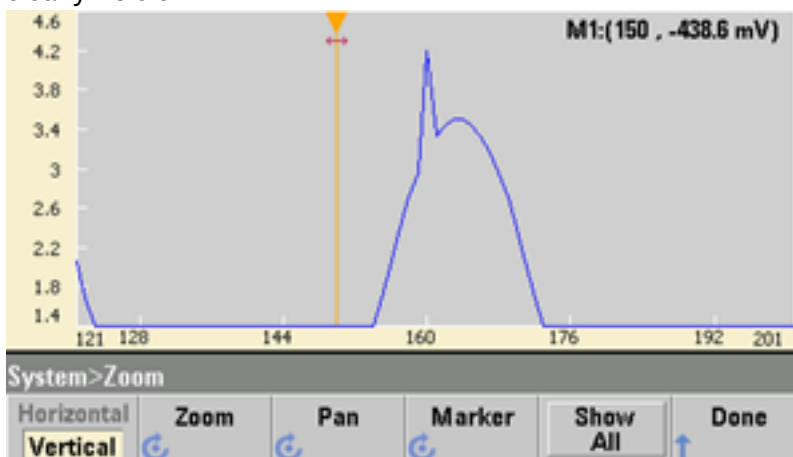



## Operating Information

- To see the entire waveform again, press **Show All**. Then press **Done** and **Done** again to return to the **Edit Points** screen.



## Insert, Remove, Copy and Paste Points

- Press **Insert Point** 15 times and watch the display carefully. You will see 15 new waveform points at the same voltage level.



- Change the **Point #** to 220 and press **Remove Point** 20 times, watching the display carefully as you do so in order to see the points being removed from the waveform.



- You can also edit points by using a table of voltages. Press **Advanced Edit > Edit Via Table**. Set **Point #** to 200, and then set the **Voltage** for point 200 to 3 V. Use the knob to move between rows and set the **Voltage** for points 205 and 210 to 3 V. Press **Done**.

Point No. (Max 403)	Voltage Value (Volts)
203	-3.49309
204	-3.49309
205	3.00000
206	-3.32870
207	-3.16690
208	-2.95515
209	-2.69680
210	3.00000

Edit Points>Table 210

Point # Voltage Insert Point Remove Point Done

- Notice the three 3 V spikes that you just made in the waveform at points 200, 205, and 210.

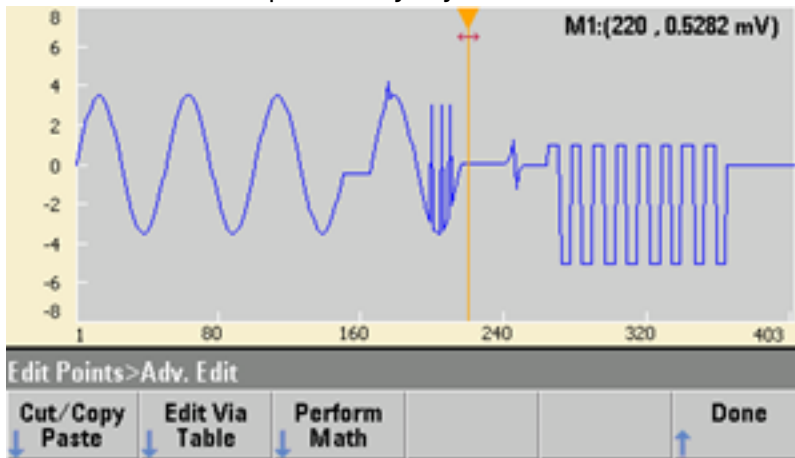

- Press **Cut/Copy Paste**, and set **Marker 1** to 150. Then press the first softkey and change the **Marker** to **Marker 2**. Set **Marker 2** to 300. The range defined by the markers is now highlighted in black.



## Operating Information

6. Press **Copy**, then **Paste**, and then **At Start**. Notice that section you copied is now duplicated at the beginning of the waveform.

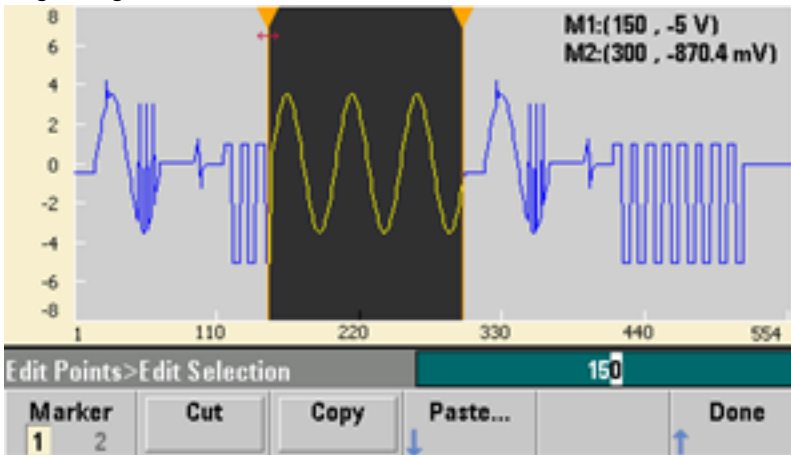

7. Now press **Paste > At End**. The same section of the waveform now also appears at the very end.

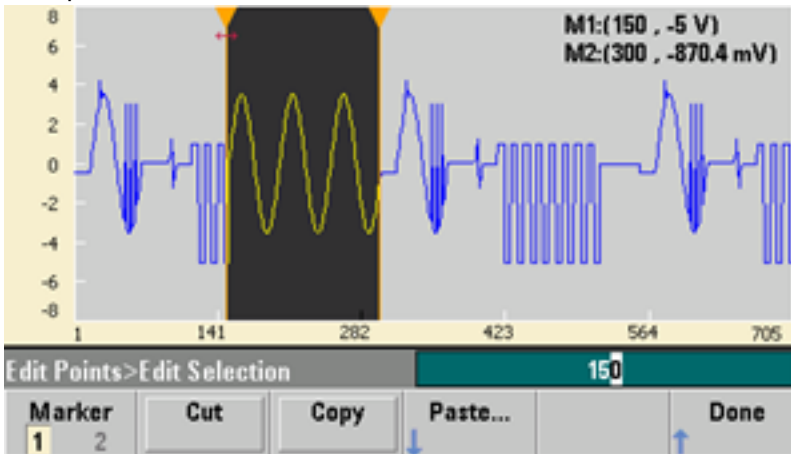

8. Now press **Paste** and change the **Point #** to 500. Then press **OK**, and the same portion of the waveform will be pasted in at point 500. Press **Done** to leave the **Cut/Copy Paste** menu.

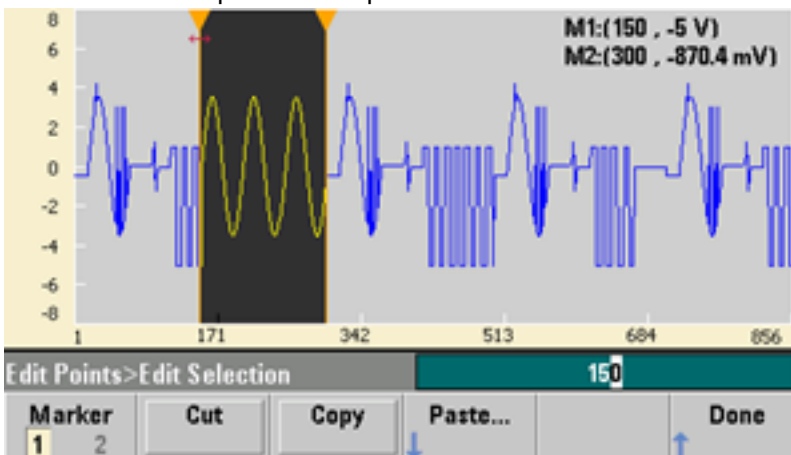

## Perform Math

The embedded waveform editor allows you to perform mathematical operations on the waveform. First you set markers to define the range of the waveform that you want to modify. You can then add, subtract or multiply that portion of the waveform by another waveform, or you can transform the waveform in ways that do not involve other waveforms.

1. Press **Perform Math**. Set **Marker 1** to 400 and **Marker 2** to 500.

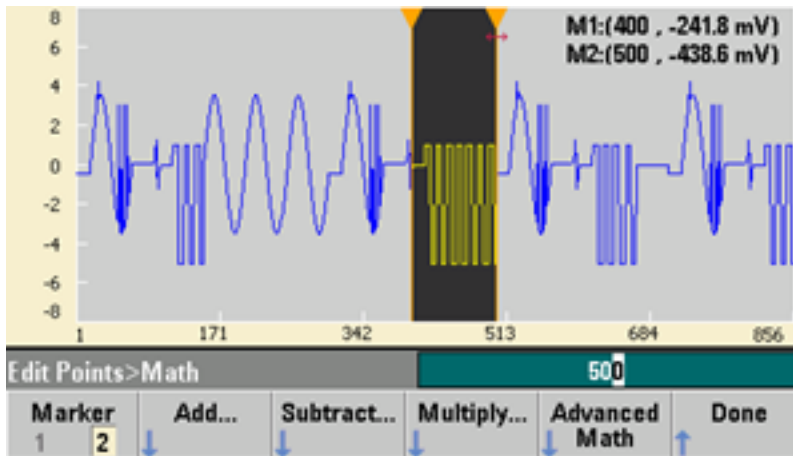

2. Press **Add**, then select **Haversine** and **OK**. Set the **Amplitude** to 3 V, the **Offset** to 0 V, and press **OK**. Notice that the highlighted section now rises in the middle as a result of the **Haversine** addition.

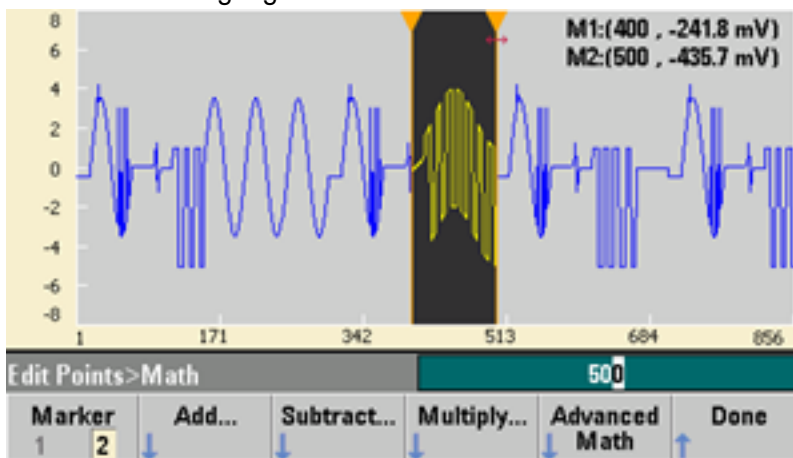

## Operating Information

- Now press **Multiply** and select the **Sine** wave (press **OK**). Set the **Cycles** to 2 and press **OK**.

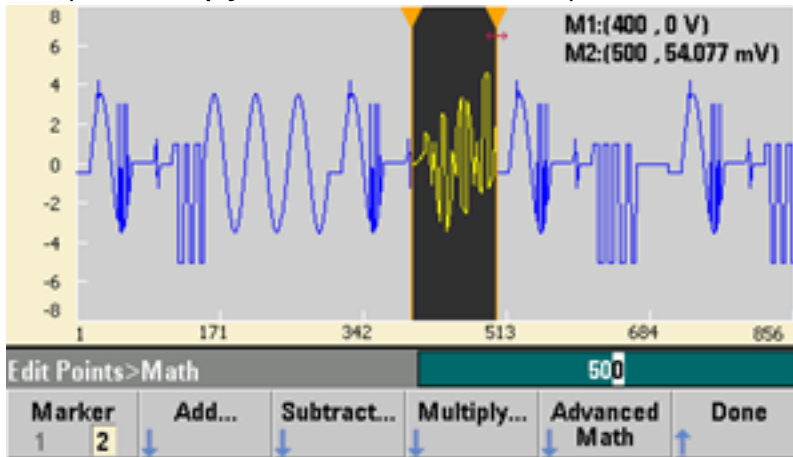

- Now set **Marker 1** to 200 and **Marker 2** to 600.

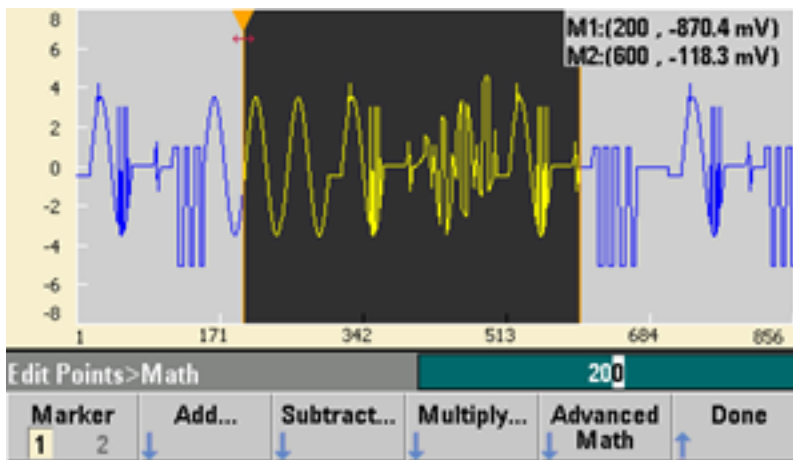

- Press **Advanced Math > Mirror > OK**.

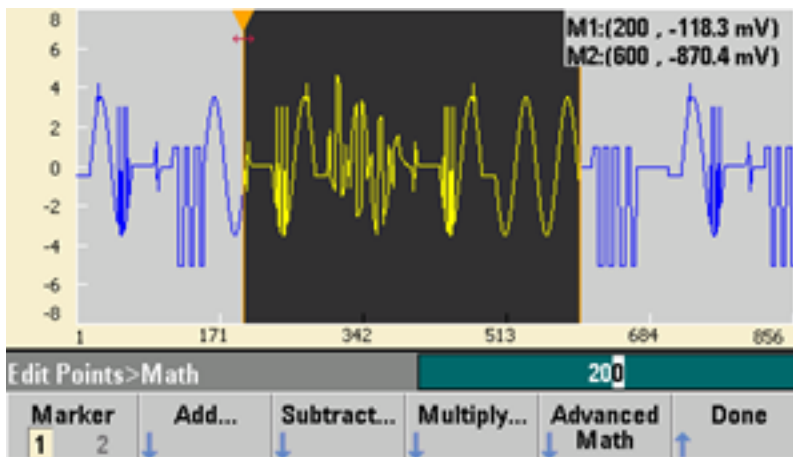

- Continue learning about the interface by trying other **Advanced Math** features, such as **Invert**, **Absolute**, **Scale**, and so on. Press **Operation Help** for more information.

## Features and Functions

This section contains details on instrument features, including front panel and remote interface operation. You may want to read [Front Panel Menu Reference](#) first. See [SCPI Programming Reference](#) for details on SCPI commands and queries. This section covers:

- [Output Configuration](#)
- [Pulse Waveforms](#)
- [Amplitude Modulation \(AM\) and Frequency Modulation \(FM\)](#)
- [Phase Modulation \(PM\)](#)
- [Frequency-Shift Keying \(FSK\) Modulation](#)
- [Pulse Width Modulation \(PWM\)](#)
- [Sum Modulation](#)
- [Frequency Sweep](#)
- [Burst Mode](#)
- [Triggering](#)
- [Dual Channel Operations](#)
- [IQ Player \(Optional\)](#)
- [System-Related Operations](#)
- [Remote Interface Configuration](#)
- [External Timebase Reference](#)
- [Embedded Waveform Editor](#)

Throughout this document, "default" states and values are identified. These are the [power-on default states](#) provided you have not enabled the power-down recall mode (see [Instrument State Storage](#)).

### Output Configuration

This section describes output channel configuration. Many commands associated with output configuration start with SOURce1: or SOURce2: to indicate a certain channel. If omitted, the default is channel 1. For example, [VOLT 2.5](#) sets the output on channel 1 to 2.5 V, and [SOUR2:VOLT 2.5](#) does the same for channel 2.

The instrument's display includes a "tab" for each channel that summarizes various aspects of each channel's output configuration:



```
Square, ON, 50Ω
Linear Sweep, Trig Imm
```

On a two-channel instrument, the tab for channel 1 will be yellow, and the tab for channel 2 will be green.

### Output Function

The instrument includes eight standard waveforms: sine, square, ramp, pulse, triangle, noise, PRBS (pseudo-random binary sequence), and DC. There are also nine built-in arbitrary waveforms, and you can create custom waveforms with the embedded waveform editor.

The table below shows which functions are allowed (·) with modulation, sweep, and burst. Selecting a function that is not allowed with a modulation or mode disables the modulation or mode.

Carrier	AM	FM	PM	FSK	BPSK	PWM	Sum	Burst	Sweep
Sine and Square	·	·	·	·	·		·	·	·
Pulse	·	·	·	·	·	·	·	·	·
Triangle and Ramp	·	·	·	·	·		·	·	·
Gaussian Noise	·						·	· <sup>a</sup>	
PRBS	·	·	·				·	·	
Arbitrary Waveform	·	·	· <sup>b</sup>		· <sup>b</sup>		·	·	·
Sequence	·						·		

(a) Gated burst only

(b) Applies to sample clock, not whole waveform

- Frequency Limitations: Changing functions may change the frequency to meet the new function's frequency limits.
- Amplitude Limitations: When the output units are Vrms or dBm, changing functions may lower the amplitude to the maximum for the new function due to variation in waveform shapes. For example, a 5 Vrms square wave (into 50 Ω) changed to a sine will decrease to 3.536 Vrms (sine's upper limit).
- Amplitude and offset cannot combine to exceed the instrument's capability. The one you set last may be changed to stay within limits.
- You may protect a device under test (DUT) by specifying upper and lower output voltage limits.

- Front Panel:

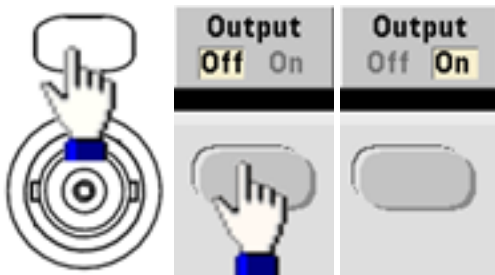

To select another waveform:



- For example, to specify a DC signal:



To produce the DC output:

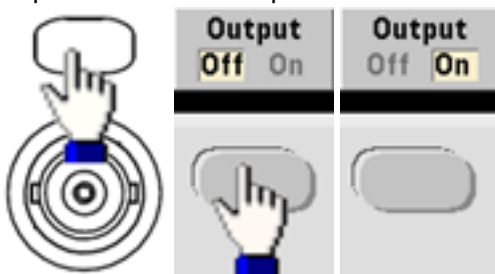

- **SCPI:** `[SOURCE[1|2]:]FUNCTION <function>`

The **APPLY** command configures a waveform with one command.



## Output Frequency

The output frequency range depends on the function, model, and output voltage, as shown [here](#). The default frequency is 1 kHz for all functions, and the minimum frequencies are shown in the table below.

Function	Minimum Frequency
Sine	1 $\mu$ Hz
Square	1 $\mu$ Hz
Ramp/Tri.	1 $\mu$ Hz
Pulse	1 $\mu$ Hz
PRBS	1 $\mu$ bps
Arbitrary	1 $\mu$ Sa/s

- **Frequency Limitations:** Changing functions may change the frequency to meet the new function's frequency limits. Arbitrary waveforms retain their last frequency setting.
- **Burst Limitation:** For internally-triggered bursts, the minimum frequency is 126  $\mu$ Hz.
- **Duty Cycle Limitations:** For Square and Pulse, Duty Cycle on the 33500 Series is limited by the 16-ns minimum pulse width specification. For example, at 1 kHz, Duty Cycle may be set as low as 0.01%, because that would result in a pulse width of 100 ns. At 1 MHz, the minimum Duty Cycle is 1.6%, and at 10 MHz it is 16%. Changing to a frequency that cannot produce the current duty cycle will adjust the duty cycle to meet the minimum pulse width specification.

On the 33500 Series, the minimum pulse width is 16 ns. On the 33600 Series, the minimum pulse width is 5 ns up to 4 Vpp and 8 ns up to 10 Vpp.

- **Front Panel:**

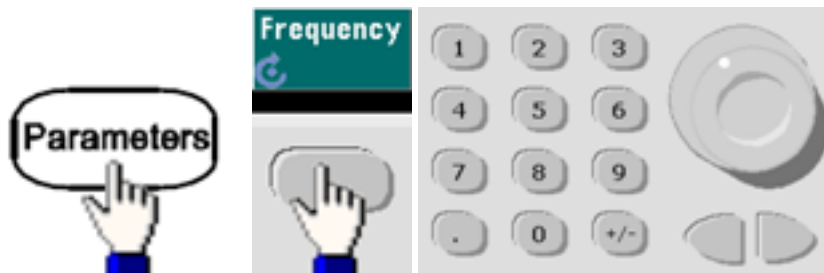

- **SCPI:** `[SOURCE[1|2]:]FREQUENCY {<frequency>|MINimum|MAXimum|DEFault}`

The **APPLY** command configures a waveform with one command.

## Output Amplitude

The default amplitude is 100 mVpp (into 50  $\Omega$ ) for all functions.

- **Offset Voltage Limitations:** The relationship between amplitude and offset is shown below.  $V_{max}$  is  $\pm 5$  V for a 50  $\Omega$  load or  $\pm 10$  V for a high-impedance load.

$$V_{pp} < 2(V_{max} - |V_{offset}|)$$

- **Limits Due to Output Termination:** If the amplitude is 10 Vpp and you change the output termination setting from 50  $\Omega$  to "high impedance" (**OUTPut[1|2]:LOAD INF**), the displayed amplitude doubles to 20 Vpp. Changing from "high impedance" to 50  $\Omega$  halves the displayed amplitude. The output termination setting does not affect the actual output voltage; it only changes the values displayed and queried from the remote interface. Actual output voltage depends on the connected load.
- **Limits Due to Units Selection:** Amplitude limits are sometimes determined by the output units selected. This may occur when the units are Vrms or dBm due to the differences in various functions' crest factors. For example, if you change a 5 Vrms square wave (into 50  $\Omega$ ) to a sine wave, the instrument will adjust the amplitude to 3.536 Vrms (the upper limit for sine in Vrms). The remote interface will also generate a "Settings conflict" error.
- You can set the output amplitude in Vpp, Vrms, or dBm. You cannot specify output amplitude in dBm if output termination is set to high impedance. See **Output Units** for details.
- **Arbitrary Waveform Limitations:** For arbitrary waveforms, amplitude is limited if the waveform data points do not span the full range of the output DAC (Digital-to-Analog Converter). For example, the built-in "Sinc" waveform does not use the full range of values, so its maximum amplitude is limited to 6.087 Vpp (into 50  $\Omega$ ).
- Changing amplitude may briefly disrupt output at certain voltages due to output attenuator switching. The amplitude is controlled, however, so the output voltage will never exceed the current setting while switching ranges. To prevent this disruption, disable voltage autoranging using **VOLTage:RANGe:AUTO OFF**. The **APPLY** command automatically enables autoranging.
- Setting the high and low levels also sets the waveform amplitude and offset. For example, if you set the high level to +2 V and the low level to -3 V, the resulting amplitude is 5 Vpp, with a -500 mV offset.
- A DC signal's output level is controlled by the offset voltage (**DC Offset Voltage**). The DC level may be between  $\pm 5$  V into a 50  $\Omega$  load or  $\pm 10$  V with a high-impedance load.

## Operating Information

- Front Panel:



To use a high level and low level instead:



- SCPI:

`[SOURCE[1|2]:]VOLTage {<amplitude>|MINimum|MAXimum|DEFAULT}`

`[SOURCE[1|2]:]VOLTage:HIGH {<voltage>|MINimum|MAXimum|DEFAULT}`

`[SOURCE[1|2]:]VOLTage:LOW {<voltage>|MINimum|MAXimum|DEFAULT}`

The **APPLY** command configures a waveform with one command.

## DC Offset Voltage

The default offset is 0 V for all functions.

- **Limits Due to Amplitude:** The relationship between offset voltage and output amplitude is shown below. The peak output voltage (DC plus AC) cannot exceed the instrument output rating ( $\pm 5$  V into 50  $\Omega$  load, or  $\pm 10$  V into an open circuit).
- The relationship between offset voltage and output amplitude is shown below.  $V_{max}$  is the maximum peak voltage for the selected output termination (5 V for a 50  $\Omega$  load or 10 V for a high-impedance load).

$$|V_{offset}| < V_{max} - V_{pp}/2$$

If the specified offset voltage is not valid, the instrument will adjust it to the maximum DC voltage allowed with the specified amplitude. From the remote interface, a "Data out of range" error will also be generated.

- **Limits Due to Output Termination:** The offset range depends on the output termination setting. For example, if you set offset to 100 mVDC and then change output termination from 50  $\Omega$  to "high impedance," the offset voltage displayed on the front panel doubles to 200 mVDC (no error is generated). If you change from "high impedance" to 50  $\Omega$ , the displayed offset voltage will be halved. See **OUTPut[1|2]:LOAD** for details. Changing the output termination setting does not change the voltage present at the output terminals of the instrument. This only changes the displayed values on the front panel and the values queried from the remote interface. The voltage present at the instrument's output depends on the load connected to the instrument. See **OUTPut[1|2]:LOAD** for details.
- **Arbitrary Waveform Limitations:** For arbitrary waveforms, amplitude is limited if the waveform data points do not span the full range of the output DAC (Digital-to-Analog Converter). For example, the built-in "Sinc" waveform does not use the full range of values, so its maximum amplitude is limited to 6.087 Vpp (into 50  $\Omega$ ).
- Setting the high and low levels also sets the waveform amplitude and offset. For example, if you set the high level to +2 V and the low level to -3 V, the resulting amplitude is 5 Vpp, with a -500 mV offset.
- To output a DC voltage level, select the DC voltage function (**FUNCTion DC**) and then set the offset voltage (**VOLTage:OFFSet**). Valid values are between  $\pm 5$  VDC into 50  $\Omega$  or  $\pm 10$  VDC into an open circuit. While the instrument is in DC mode, setting amplitude has no effect.

- **Front Panel:**

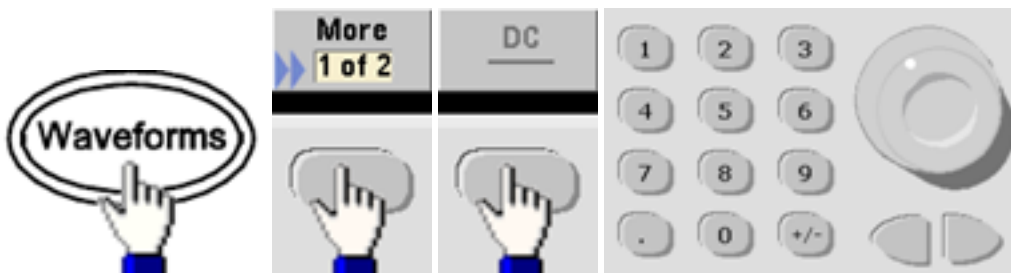

## Operating Information

- **SCPI:**  
`[SOURCE[1|2]:]VOLTage:OFFSet {<offset>|MINimum|MAXimum|DEFAULT}`  
`[SOURCE[1|2]:]VOLTage:HIGh {<voltage>|MINimum|MAXimum|DEFAULT}`  
`[SOURCE[1|2]:]VOLTage:LOW {<voltage>|MINimum|MAXimum|DEFAULT}`

The **APPLY** command configures a waveform with one command.

## Output Units

Applies to output amplitude only.

- Output units: Vpp (default), Vrms, or dBm.
- Setting is volatile.
- Units selection applies to front panel and remote interface operations. For example, if you select "VRMS" remotely, the units are displayed as "VRMS" on the front panel.
- Amplitude units cannot be dBm if output termination set to high impedance. Calculating dBm requires finite load impedance. In this case, units are converted to Vpp.
- You can convert between units. For example, to convert 2 Vpp to Vrms equivalent:

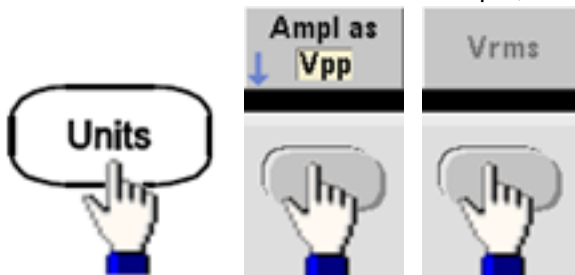

The converted value is 707.1 mVrms for a sine wave.

- **Front Panel:**

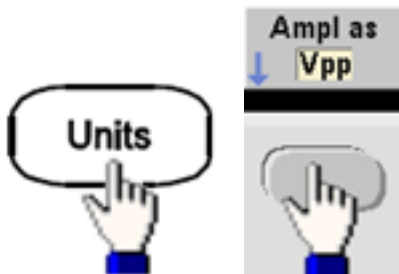

- **SCPI:** `[SOURCE[1|2]:]VOLTage:UNIT {VPP|VRMS|DBM}`

## Output Termination

The instrument has a fixed series output impedance of 50 Ω to the front panel channel connectors. If the actual load impedance differs from the value specified, the displayed amplitude and offset levels will be incorrect. The load impedance setting is simply a convenience to ensure that the displayed voltage matches the expected load.

- Output termination: 1 Ω to 10 kΩ, or infinite. The default is 50 Ω. The tab at the top of each channel indicates the value of this setting.

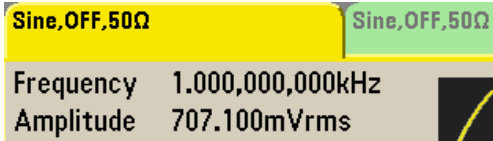

- If you specify a 50 Ω termination but actually terminate into an open circuit, the output will be twice the value specified. For example, if you set the DC offset to 100 mVDC (and specify a 50 Ω load) but terminate into an open circuit, the actual offset will be 200 mVDC.
- Changing output termination setting, adjusts displayed output amplitude and offset (no error is generated). If the amplitude is 10 Vpp and you change the output termination setting from 50 Ω to "high impedance" (OUTPut[1|2]:LOAD INF), the displayed amplitude doubles to 20 Vpp. Changing from "high impedance" to 50 Ω halves the displayed amplitude. The output termination setting does not affect the actual output voltage; it only changes the values displayed and queried from the remote interface. Actual output voltage depends on the connected load.

**NOTE** The output load can affect signal quality for pulse or other functions with high-speed transitions. High load resistance can produce reflections.

- Units are converted to Vpp if output termination is high impedance.
- You cannot change output termination with voltage limits enabled, because instrument cannot know which termination setting the limits apply to. Instead, disable voltage limits, set the new termination value, adjust voltage limits, and re-enable voltage limits.

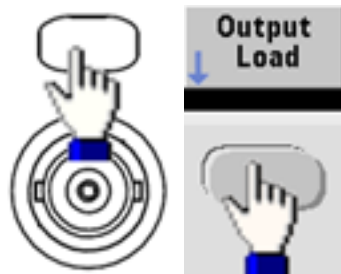

Front Panel:

- **SCPI:** `OUTPut[1|2]:LOAD {<ohms>|INFinity|MINimum|MAXimum|DEFault}`

### Duty Cycle (Square Waves)

A square wave's duty cycle is the fraction of time per cycle that the waveform is at a high level (assuming the waveform is not inverted). (See [Pulse Waveforms](#) for pulse duty cycle details.)

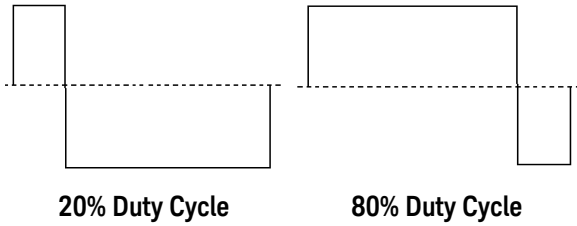

- Duty Cycle: 0.01% to 99.99% at low frequencies; range reduced at higher frequency. Stored in volatile memory; default 50%.
- This setting is remembered when you change to another function. A 50% duty cycle is always used for a modulating square waveform; the duty cycle setting applies only to a square wave carrier.
- **Front Panel:**



If you use the keypad, press **Percent** to finish:



- **SCPI:** `[SOURce[1|2]:]FUNction:SQUare:DCYcle {<percent>|MINimum|MAXimum}`

The **APPLY** command sets the duty cycle to 50%.

### Symmetry (Ramp Waves)

Applies to ramp waves only. Symmetry represents the fraction of each cycle that the ramp wave is rising (assuming waveform is not inverted).

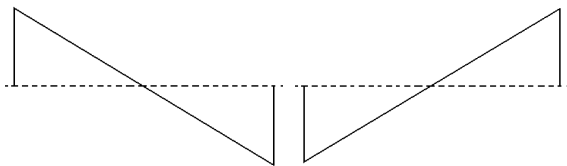

0% Symmetry

100% Symmetry

- The symmetry (default 100%) is stored in volatile memory; and is remembered when you change to and from other waveforms.
- When ramp is the modulating waveform for AM, FM, PM, or PWM, the symmetry setting does not apply.

- **Front Panel:**

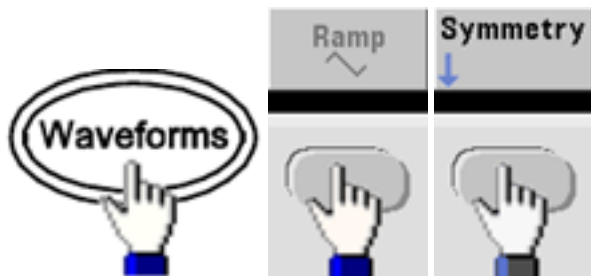

Then choose one of the following options. The **Symmetry** option allows you to use the knob or keypad to specify a value.

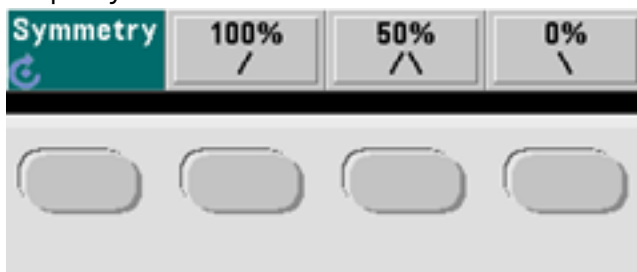

If you use the keypad, press **Percent** to finish:

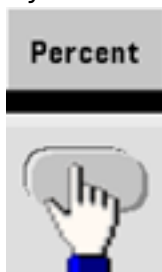

- **SCPI:** `[SOURCE[1|2]:]FUNCTION:RAMP:SYMMetry {<percent>|MINimum|MAXimum|DEFAULT}`

The **APPLY** command sets the symmetry to 100%.



## Voltage Autoranging

Autoranging is enabled by default and the instrument selects optimal attenuator settings. With autoranging disabled, the instrument uses the current attenuator settings and does not switch attenuator relays.

- You can disable autoranging to eliminate momentary disruptions caused by attenuator switching while changing amplitude. However:
- The amplitude and offset accuracy and resolution (and waveform fidelity) may be adversely affected when reducing the amplitude below a range change that would occur with autoranging on.
- You may not achieve minimum amplitude with autoranging on.
- Some instrument specifications do not apply with autoranging off.

- **Front Panel:**

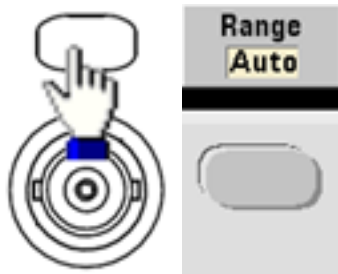

or

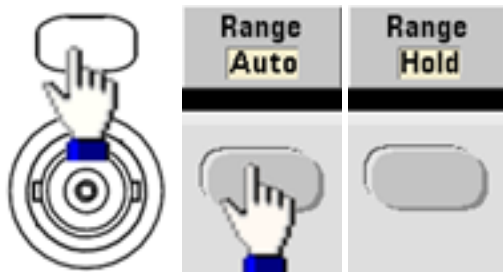

- **SCPI:** `[SOURce[1|2]:]VOLTage:RANGe:AUTO {OFF|0|ON|1|ONCE}`

The **APPLY** command always enables autoranging.

## Output Control

By default, channel output is disabled at power on to protect other equipment. To enable a channel's output, see below. When channel output is enabled, the corresponding channel button is lit.

- If an external circuit applies excessive voltage to a channel output connector, the instrument generates an error message and disables the output. To re-enable output, remove the overload and turn the channel on again.
- **Front Panel:**

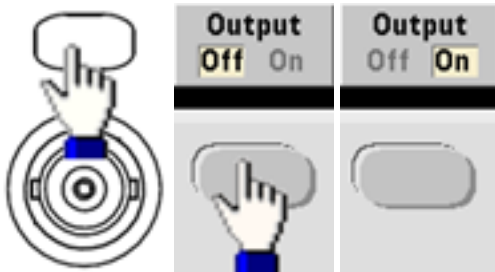

- **SCPI:** `OUTPut[1|2] {ON|1|OFF|0}`

The **APPLY** command always enables the channel output connector.

### Waveform Polarity

In normal mode (default), the waveform goes positive at the beginning of the cycle. Inverted mode does the opposite.

- As shown below, the waveform is inverted relative to the offset voltage. The offset voltage remains unchanged when the waveform is inverted.

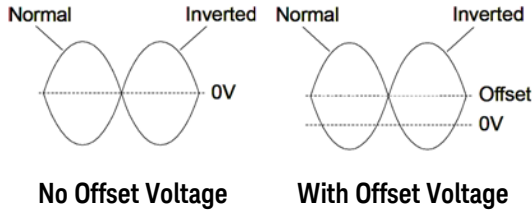

- The **Sync** signal associated with an inverted waveform is not inverted.
- **Front Panel:**

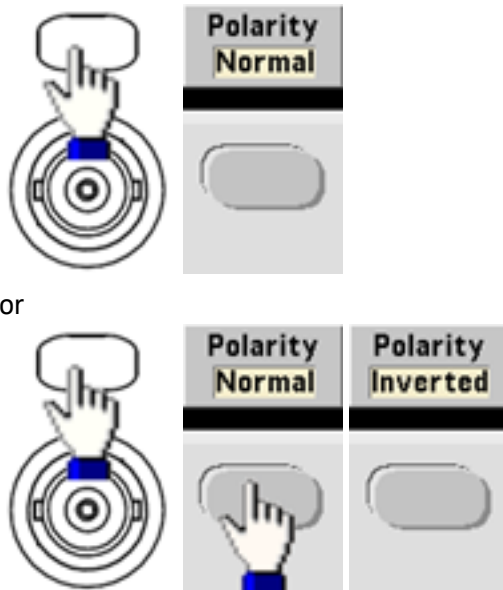

- **SCPI:** `OUTPut[1|2]:POLarity {NORMal|INVerted}`

## Sync Output Signal

A sync output is provided on the front panel **Sync** connector. All of the standard output functions (except DC and noise) have an associated **Sync** signal. For applications where you may not want to output the **Sync** signal, you can disable the **Sync** connector. The **Sync** signal may be derived from either output channel in a two-channel instrument.

### General Behavior

- By default, the **Sync** signal is derived from channel 1 and is routed to the **Sync** connector (enabled).
- When the **Sync** signal is disabled, the output level on the **Sync** connector is at a logic "low."
- The polarity of the **Sync** signal is specified by `OUTPut:SYNC:POLarity {INVerted|NORMal}`.
- Inverting a waveform (see [Waveform Polarity](#)), does not invert the associated **Sync** signal .
- For sine, pulse, ramp, square, and triangle waves, the **Sync** signal is a square wave that is "high" in the first half of the cycle and "low" in the last half. The **Sync** signal's voltages are TTL-compatible when its load impedance exceeds 1 k $\Omega$ .
- For arbitrary waveforms, the **Sync** signal rises at the beginning of the waveform and falls at the middle of the arbitrary waveform. You can override this default behavior by using `MARKer:POINT` to specify the point within the arbitrary waveform at which the **Sync** signal transitions to "low."

### Modulation

- For internally-modulated AM, FM, PM, and PWM, the **Sync** signal is normally referenced to the modulating waveform (not the carrier) and is a square waveform with a 50% duty cycle. The **Sync** signal is a TTL "high" during the first half of the modulating waveform. You can set up the **Sync** signal to follow the carrier waveform by using the command `OUTPut:SYNC:MODE {CARRier|NORMal|MARKer}` when modulating with internal modulation.
- For externally-modulated AM, FM, PM, and PWM, the **Sync** signal is referenced to the carrier waveform (not the modulating waveform) and is a square waveform with a 50% duty cycle.
- You can override normal sync behavior to force **Sync** to always follow the carrier waveform (`OUTPut [1|2]:SYNC:MODE CARRier`).
- For FSK, the **Sync** signal is referenced to the FSK rate. The **Sync** signal is a TTL "high" on the transition to the "hop" frequency.

### Sweep

- The **Sync** signal is a TTL "high" at the beginning of the sweep and goes "low" at the sweep's midpoint. The **Sync** signal is synchronized with the sweep, but is not equal to the sweep time because its timing includes the re-arm time.
- For frequency sweeps with Marker On, the **Sync** signal is a TTL "high" at the beginning of the sweep and a "low" at the marker frequency. You can change this with `OUTPut[1|2]:SYNC:MODE MARKer`.

## Operating Information

### Burst

- For a triggered burst, the **Sync** signal is a TTL "high" when the burst begins. The **Sync** signal is a TTL "low" at the end of the specified number of cycles (may not be the zero-crossing point if the waveform has an associated start phase). For an infinite count burst, the **Sync** signal is the same as for a continuous waveform.
- For an externally-gated burst, the **Sync** signal follows the external gate signal. However, the signal will not go "low" until the end of the last cycle (may not be a zero-crossing if the waveform has an associated start phase).

### Configuring Sync Output

- **Front Panel:**

To toggle **Sync** off and on:

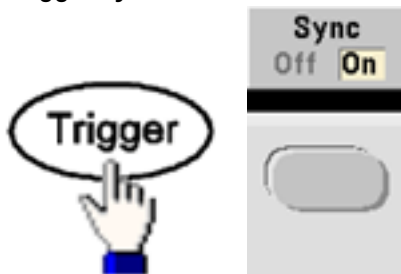

To configure Sync:

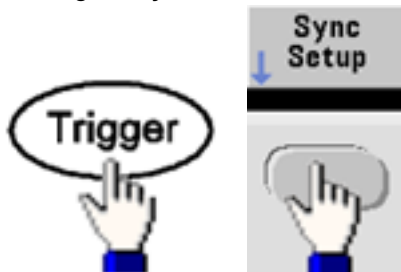

- **SCPI:**

```
OUTPut:SYNC {ON|OFF|0}
```

```
OUTPut[1|2]:SYNC:MODE {NORMal|CARRier|MARKer}
```

```
OUTPut[1|2]:SYNC:POLarity {NORMal|INVerted}
```

```
OUTPut:SYNC:SOURce {CH1|CH2}
```

### Pulse Waveforms

As shown below, a pulse or square wave consists of a period, a pulse width, a rising edge, and a falling edge.

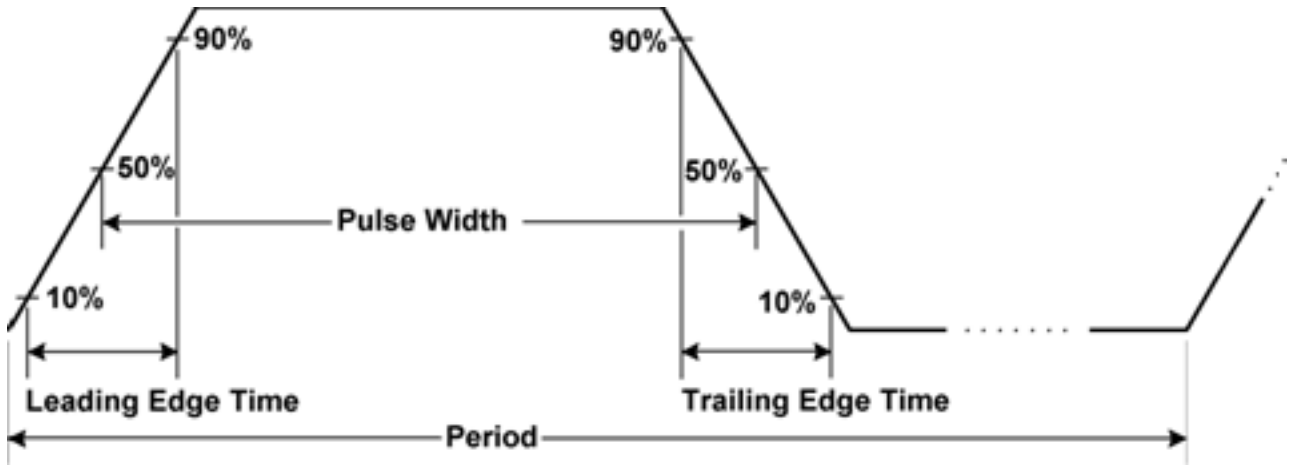

## Period

- Period: reciprocal of maximum frequency to 1,000,000 s. The default is 1 ms.
- The instrument adjusts the pulse width and edge time as needed to accommodate the specified period.

- **Front Panel:**

Select Pulse waveform:

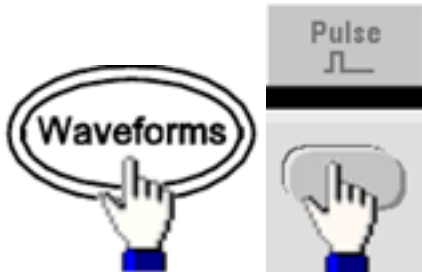

Select period instead of frequency:



Set the period:

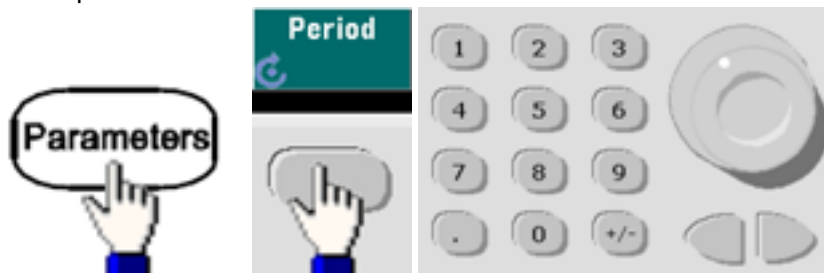

- **SCPI:** `[SOURce[1|2]:]FUNction:PULSe:PERiod {<seconds>|MINimum|MAXimum|DEFault}`

## Pulse Width

Pulse width is the time from the 50% threshold of a pulse's rising edge to the 50% threshold of the next falling edge.

- Pulse width: up to 1,000,000 s (see restrictions below). The default pulse width is 100  $\mu$ s. The minimum pulse width is 16 ns on the 33500 Series and 5 ns up to 4 Vpp or 8 ns up to 10 Vpp on the 33600 Series.
- The specified pulse width must also be less than the difference between the period and the minimum pulse width.
- The instrument will adjust the pulse width to accommodate the specified period.

- **Front Panel:**



- **SCPI:** `[SOURce[1|2]:]FUNCTION:PULSE:WIDTH {<seconds>|MINimum|MAXimum|DEFAULT}`



### Pulse Duty Cycle

The pulse duty cycle is defined as follows:

$$\text{Duty Cycle} = 100(\text{Pulse Width})/\text{Period}$$

Pulse width is the time from the 50% threshold of a pulse's rising edge to the 50% threshold of the next falling edge.

- Pulse duty cycle: 0.01% to 99.99% (see restrictions below). The default is 10%.
- The pulse duty cycle must conform to the following restrictions determined by the minimum pulse width ( $W_{\min}$ ). The instrument will adjust the pulse duty cycle to accommodate the specified period.

$$\text{Duty Cycle} > 100(\text{Minimum Pulse Width}) / \text{Period}$$

and

$$\text{Duty Cycle} < 100(1 - (\text{Minimum Pulse Width} / \text{Period}))$$

The minimum pulse width is 16 ns on the 33500 Series and 5 ns up to 4 Vpp or 8 ns up to 10 Vpp on the 33600 Series.

- The longer the edges, the greater the minimum pulse width. Longer edges will therefore restrict duty cycle more than shorter edges.

- **Front Panel:**

Select pulse function:

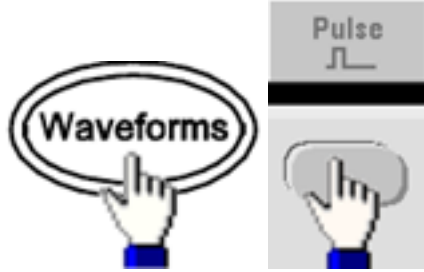

Toggle to Duty Cycle:



Enter the Duty Cycle:



- **SCPI:** `[SOURCE[1|2]:]FUNCTION:PULSE:DCYCLE {<percent>|MINimum|MAXimum|DEFAULT}`

## Edge Times

The edge times set the transition times for the leading and trailing edges of the pulse, either independently or together. The edge time represents the time between the 10% and 90% thresholds.

- Edge time: Minimum of 8.4 ns on the 33500 Series, and 2.9 ns up to 4 Vpp, or 3.3 ns up to 10 Vpp on the 33600 Series. Maximum of 1  $\mu$ s and default 10 ns.
- The specified edge time must fit within the specified pulse width **as shown above**. The instrument will adjust the edge time to accommodate the specified pulse width.

- **Front Panel:**

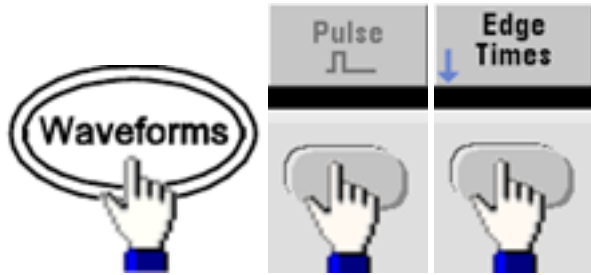

- **SCPI:**

`[SOURce[1|2]:]FUNction:PULSe:TRANSition:LEADing {<seconds>|MINimum|MAXimum|DEFault}`

`[SOURce[1|2]:]FUNction:PULSe:TRANSition:TRAILing {<seconds>|MINimum|MAXimum|DEFault}`

`[SOURce[1|2]:]FUNction:PULSe:TRANSition[:BOTH] {<seconds>|MINimum|MAXimum|DEFault}`

## Amplitude Modulation (AM) and Frequency Modulation (FM)

A modulated waveform consists of a carrier waveform and a modulating waveform. In AM, the carrier amplitude is varied by the voltage level of the modulating waveform. In FM, the carrier frequency is varied by the voltage level of the modulating waveform. The instrument accepts an internal or external modulation source. On a two-channel instrument, one channel can modulate the other.

Select AM or FM before setting up any other modulation parameter. For more information on modulation, see [Modulation](#).

### To Select AM or FM

- The instrument allows only one modulation mode to be enabled on a channel. When you enable AM or FM, all other modulations are off. On two-channel models, the two channels' modulations are independent from one another, and the instrument can add modulated waveforms from two channels. See [PHASe:SYNChronize](#) and [COMBine:FEED](#) for details.
- The instrument will not allow AM or FM to be enabled with sweep or burst. Enabling AM or FM, turns off sweep and burst.
- To avoid multiple waveform changes, enable modulation after configuring the other modulation parameters.

- Front Panel:

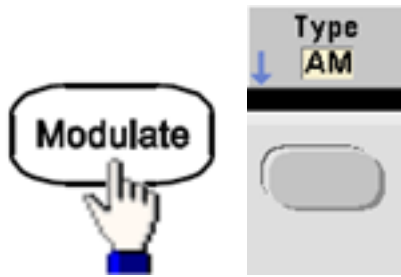

or

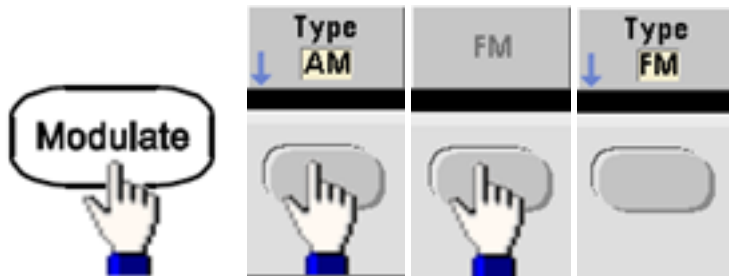

Then turn modulation on:

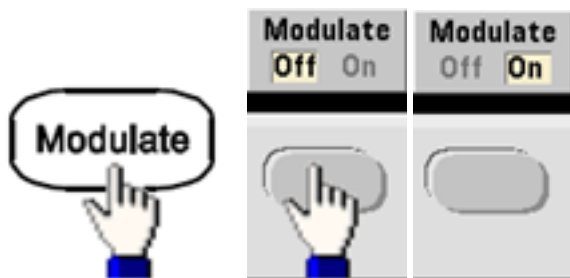

The waveform is output using the present carrier and modulating waveform settings.

- SCPI:

`[SOURCE[1|2]:]AM:STATE{ON|1|OFF|0}`

`[SOURCE[1|2]:]FM:STATE {ON|1|OFF|0}`

### Carrier Waveform Shape

- AM or FM carrier shape: Sine (default), Square, Ramp, Pulse, Triangle, Noise (AM only), PRBS, or Arbitrary waveform. You cannot use DC as the carrier waveform.
- For FM, the carrier frequency must always be greater than or equal to the frequency deviation. Attempting to set a deviation greater than the carrier frequency will cause the instrument to set the deviation equal to the carrier frequency.
- The carrier frequency plus the deviation cannot exceed the selected function's maximum frequency plus 100 kHz. If you attempt to set the deviation to an invalid value, the instrument adjusts it to the maximum value allowed with the present carrier frequency. The remote interface also generates a "Data out of range" error.

## Operating Information

- Front Panel:



Then select a waveform shape.

- SCPI: `[SOURce[1|2]:]FUNCTion <function>`

The **APPLY** command configures a waveform with one command.

## Carrier Frequency

The maximum carrier frequency varies by function, model, and output voltage, as shown [here](#). The default is 1 kHz for all functions other than arbitrary waveforms. Arbitrary waveform "frequency" is also set using the `FUNCTion:ARBitrary:SRATe` command.

- Front Panel:

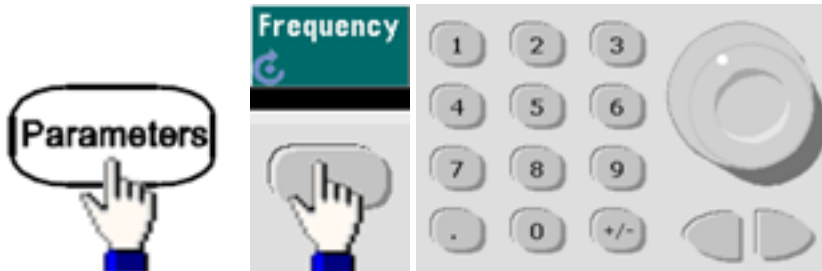

- SCPI: `[SOURce[1|2]:]FREQuency {<frequency>|MINimum|MAXimum|DEFault}`





The **APPLY** command configures a waveform with one command.

## Modulating Waveform Shape

The instrument accepts an internal or external AM or FM modulation source. On a two-channel instrument you can modulate one channel with the other.

**NOTE**

You cannot modulate noise with noise, PRBS with PRBS, or an arbitrary waveform with an arbitrary waveform.

- The modulating waveform shape (internal source) may be:
  - Sine wave
  - Square with 50% duty cycle 
  - UpRamp with 100% symmetry 
  - Triangle with 50% symmetry 
  - DnRamp with 0% symmetry 
  - Noise - white gaussian noise
  - PRBS - Pseudo Random Bit Sequence (polynomial PN7)
  - Arb - Arbitrary waveform

## Operating Information

- Front Panel:

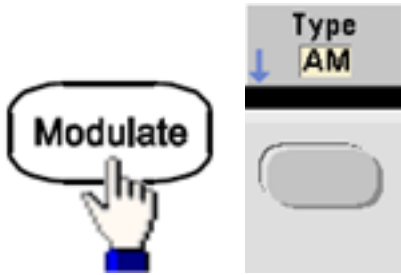

or

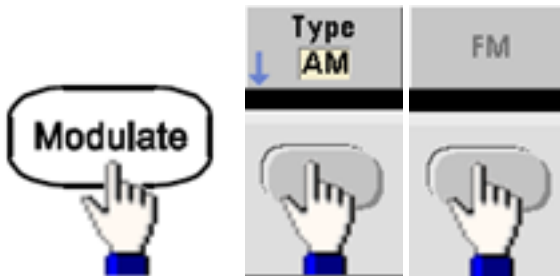

Then choose the modulating shape:



- SCPI:

`[SOURCE[1|2]:]AM:INTERNAL:FUNCTION <function>`

`[SOURCE[1|2]:]FM:INTERNAL:FUNCTION <function>`

## Modulating Waveform Frequency

The instrument accepts an internal or external modulation source.

- Modulating frequency (internal source): minimum is 1  $\mu$ Hz, and the maximum values vary by model, function, and output, as shown [here](#).
- Modulating frequency (external source): 0 to 100 kHz
- Front Panel:



or

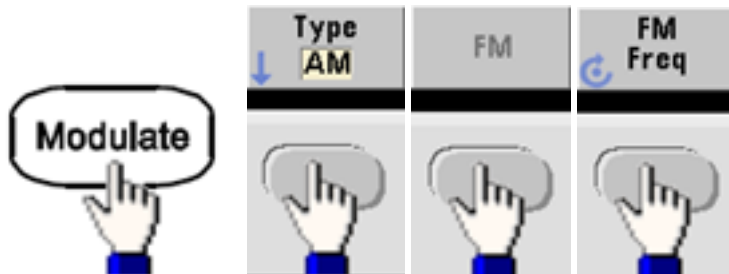

Then enter the AM or FM frequency with the knob and keypad:



- SCPI:

`[SOURCE[1|2]:]AM:INTERNAL:FREQUENCY {<frequency>|MINimum|MAXimum|DEFAULT}`

`[SOURCE[1|2]:]FM:INTERNAL:FREQUENCY {<frequency>|MINimum|MAXimum|DEFAULT}`



## Modulation Depth (AM)

The modulation depth is a percentage that represents the amplitude variation. At 0% depth, the amplitude is one-half of the carrier's amplitude setting. At 100% depth, the amplitude varies according to the modulating waveform, from 0% to 100% of the carrier's amplitude.

- Modulation depth: 0% to 120%. The default is 100%.
- Even at greater than 100% depth, the instrument will not exceed  $\pm 5$  V peak on the output (into a 50  $\Omega$  load). To achieve modulation depth greater than 100%, output carrier amplitude may be reduced.
- **Front Panel:**



- SCPI: `[SOURce[1|2]:]AM[:DEPTH] {<depth_in_percent>|MINimum|MAXimum}`

## Double Sideband Suppressed Carrier AM

The instrument supports two forms of amplitude modulation, "Normal" and Double Sideband Suppressed Carrier (DSSC). In DSSC, the carrier is not present unless the modulating signal has an amplitude greater than zero.

- **Front Panel:**



- SCPI: `[SOURce[1|2]:]AM:DSSC{ON|OFF|0}`.

## Frequency Deviation (FM)

The frequency deviation setting represents the peak variation in frequency of the modulated waveform from the carrier frequency.

When the carrier is PRBS, frequency deviation causes a change in the bit rate equal to one-half of the set frequency. For example, a 10 kHz deviation is equivalent to a 5 KBPS change in bit rate.

- Frequency deviation: 1  $\mu$ Hz to (carrier frequency)/2, default 100 Hz.
- For FM, the carrier frequency must always be greater than or equal to the frequency deviation. Attempting to set a deviation greater than the carrier frequency will cause the instrument to set the deviation equal to the carrier frequency.
- The carrier frequency plus the deviation cannot exceed the selected function's maximum frequency plus 100 kHz. If you attempt to set the deviation to an invalid value, the instrument adjusts it to the maximum value allowed with the present carrier frequency. The remote interface also generates a "Data out of range" error.
- **Front Panel:**



- **SCPI:** `[SOURce[1|2]:]FM[:DEVIation] {<peak_deviation_in_Hz>|MINimum|MAXimum|DEFault}`

## Modulating Source

The instrument accepts an internal or external modulation source. On a two-channel instrument you can modulate one channel with the other.

**NOTE**

On the 33600 Series, you can configure the modulation source to accept either a  $\pm 5$  V signal or a  $\pm 1$  V signal. See [INPut:ATTenuation\[:STATe\]](#) for details.

- Modulating source: Internal (default), Other Channel, or External. The External modulation source may be up to 100 kHz.
- With the External source, an external waveform modulates the carrier waveform. The modulation depth (AM) or frequency deviation (FM) is controlled by the signal level on the rear-panel **Modulation In** connector. The external modulation input has -3 dB bandwidth of 100 kHz.
- AM example: with modulation depth 100%, when the modulating signal is at +5 V, the output will be at the maximum amplitude. When the modulating signal at -5 V, the output will be at minimum amplitude.
- FM example: with deviation of 10 kHz, then a +5 V signal level corresponds to a 10 kHz increase in frequency. Lower external signal levels produce less deviation and negative signal levels reduce the frequency below the carrier frequency.
- **Front Panel:**  
After enabling AM or FM, select the modulating source as shown:



- **SCPI:**  
[\[SOURce\[1|2\]:\]AM:SOURce {INTernal|EXTernal|CH1|CH2}](#)  
[\[SOURce\[1|2\]:\]FM:SOURce {INTernal|EXTernal|CH1|CH2}](#)

## Phase Modulation (PM)

A modulated waveform consists of a carrier waveform and a modulating waveform. PM is very similar to FM, but in PM the phase of the modulated waveform is varied by the instantaneous voltage of the modulating waveform.

For more information on the fundamentals of Phase Modulation, see [Tutorial - Modulation](#).

### To Select Phase Modulation

- Only one modulation mode may be enabled at a time. Enabling PM disables the previous modulation mode.

- Enabling PM turns off sweep and burst.

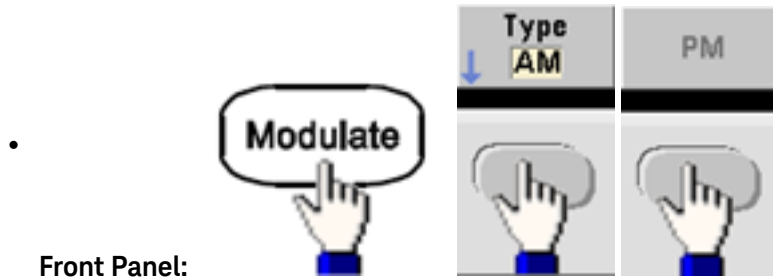

The waveform is output using the present carrier and modulating waveform settings.

- To avoid multiple waveform changes, enable modulation after configuring the other modulation parameters.
- **SCPI:** `[SOURce[1|2]:]PM:STATe {ON|1|OFF|0}`

### Carrier Waveform Shape

- PM carrier shape: Sine (default), Square, Ramp, Triangle, Pulse, PRBS, or Arbitrary. You cannot use Noise or DC as the carrier waveform.

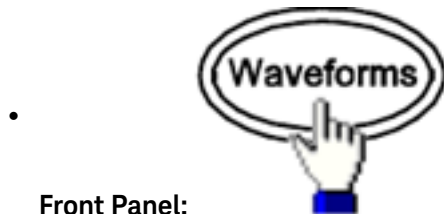

Then select any waveform except Noise or DC.

- **SCPI:** `[SOURce[1|2]:]FUNCTion <function>`
- The **APPLY** command configures a waveform with one command.
- When the carrier is an arbitrary waveform, modulation affects the sample "clock" instead of the full cycle defined by the arbitrary waveform sample set. Because of this, applying phase modulation to arbitrary waveforms is limited.

## Carrier Frequency

The maximum carrier frequency varies by function, model, and output voltage, as shown [here](#). The default is 1 kHz for all functions other than arbitrary waveforms. Carrier frequency must be greater than 20 times the peak modulation frequency.

- **Front Panel:**

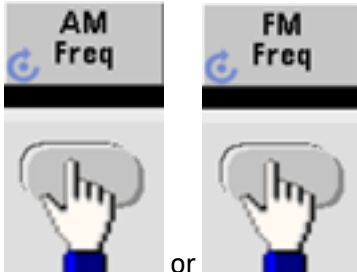

or any other Frequency key.





After selecting the frequency key:



- **SCPI:** `[SOURCE[1|2]:]FREQUENCY {<frequency>|MINimum|MAXimum|DEFault}`
- The **APPLY** command configures a waveform with one command.

## Modulating Waveform Shape

The instrument accepts an internal or external modulation source.

- The modulating waveform shape (internal source) may be:
  - Sine wave
  - Square with 50% duty cycle 
  - UpRamp with 100% symmetry 
  - Triangle with 50% symmetry 
  - DnRamp with 0% symmetry 
  - Noise - white gaussian noise
  - PRBS - Pseudo Random Bit Sequence (polynomial PN7)
  - Arbitrary waveform
- You can use noise as the modulating waveshape, but you cannot use noise or DC as the carrier waveform.

- **Front Panel:**

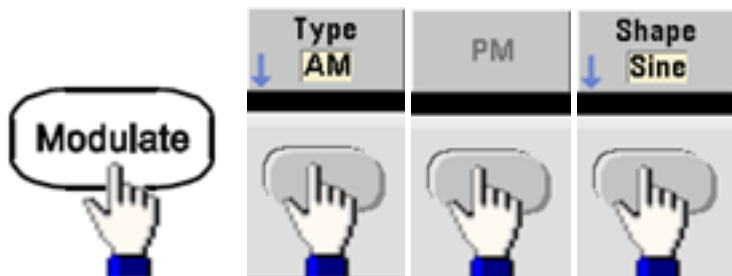

- **SCPI:** `[SOURce[1|2]:]PM:INTernal:FUNction <function>`

## Modulating Waveform Frequency

The instrument accepts an internal or external modulation source. The external modulation input has a -3dB bandwidth of 100 kHz.

- Modulating frequency (internal): default 10 Hz, minimum 1  $\mu$ Hz; maximum varies by model, function, and output voltage, as shown [here](#).
- Front Panel:

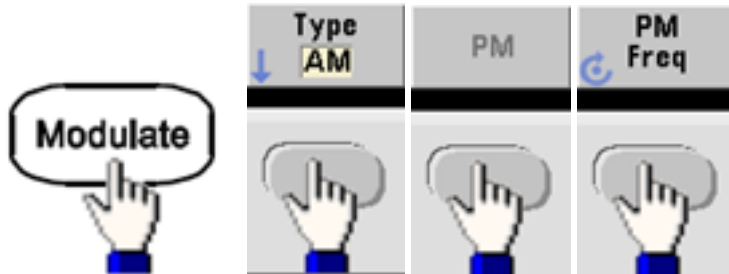

Then set the modulating waveform frequency:



- SCPI: `[SOURce[1|2]:]PM:INTernal:FREQuency {<frequency>|MINimum|MAXimum|DEFault}`

## Phase Deviation

The phase deviation setting represents the peak variation in phase of the modulated waveform from the carrier waveform. The phase deviation can be set from 0 to 360 degrees (default 180).

- Front Panel:

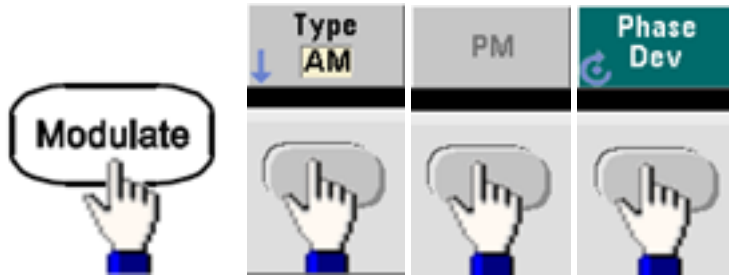

Then set the phase deviation:



- **SCPI:** `[SOURce[1|2]:]PM:DEVIation {<deviation in degrees>|MINimum|MAXimum|DEFault}`
- When the carrier is an arbitrary waveform, the deviation applies to the sample clock. Therefore, the effect on the full arbitrary waveform is much less than that seen with standard waveforms. The extent of the reduction depends on the number of points in the arbitrary waveform.



## Modulating Source

The instrument accepts an internal or external modulation source.

- Modulating source: Internal (default), Other Channel, or External. The External modulation source may be up to 100 kHz.
- With the External source, the carrier waveform is modulated with an external waveform. The  $\pm 5$  V signal level present on the rear-panel **Modulation In** connector controls the phase deviation. For example, if the deviation is set to 180 degrees, a +5 V signal corresponds to a 180 degree phase shift. Lower levels produce less deviation.
- **Front Panel:**

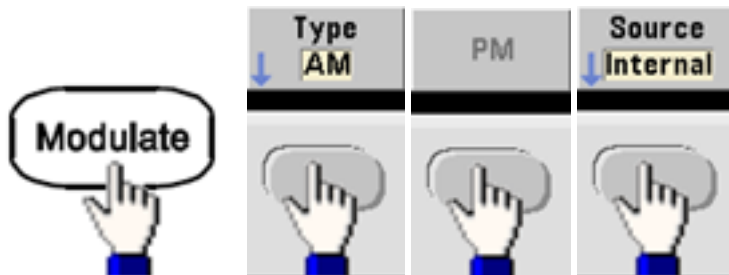

- **SCPI:** `[SOURce[1|2]:]PM:SOURce {INTernal|EXTernal|CH1|CH2}`

## Frequency-Shift Keying (FSK) Modulation

You can configure the instrument to "shift" its output frequency between two preset values (called the "carrier frequency" and the "hop frequency") using **FSK modulation**. The rate at which the output shifts between these two frequencies is determined by the internal rate generator or the signal level on the rear-panel **Ext Trig** connector.

See [Front Panel Menu Operation - Output an FSK Waveform](#) for details on FSK using the front panel.

### To Select FSK Modulation

`FSKey:STATe {OFF|ON}`

- Only one modulation mode may be enabled at a time. Enabling FSK turns off the previous modulation mode.
- You cannot enable FSK when sweep or burst is enabled. Enabling FSK turns off sweep and burst.
- To avoid multiple waveform changes, enable modulation after configuring the other modulation parameters.

### FSK Carrier Frequency

`[SOURce[1|2]:]FREQuency {<frequency>|MINimum|MAXimum|DEFault}`

The maximum carrier frequency varies by function, model, and output voltage, as shown [here](#). The default is 1 kHz for all functions other than arbitrary waveforms.

- When the External source is selected, the output frequency is determined by the signal level on the rear-panel **Ext Trig** connector. When a logic low is present, the carrier frequency is output. With a logic high, the hop frequency is output.

### FSK "Hop" Frequency

`[SOURCE[1|2]:]FSKey:FREQUENCY {<frequency>|MINimum|MAXimum|DEFAULT}`

The maximum alternate ("hop") frequency depends on the function. The default is 100 Hz for all functions. The internal modulating waveform is a 50% duty cycle square wave.

Function	Minimum Hop Frequency	Maximum Hop Frequency
Sine	1 $\mu$ Hz	(varies by model, as shown <a href="#">here</a> )
Square		
Ramp/Triangle		
Pulse		

- When the External source is selected, the output frequency is determined by the signal level on the rear-panel **Ext Trig** connector. When a logic low is present, the carrier frequency is output. With a logic high, the hop frequency is output.

### FSK Rate

`[SOURCE[1|2]:]FSKey:INTERNAL:RATE {<rate_in_Hz>|MINimum|MAXimum}`

The FSK rate is the rate at which the output frequency "shifts" between the carrier frequency and the hop frequency using the internal FSK source.

- FSK rate (internal source): 125  $\mu$ Hz (33500 Series) or 250  $\mu$ Hz (33600 Series) up to 1 MHz, default 10 Hz.
- The FSK rate is ignored when the external FSK source is selected.

### FSK Source

`[SOURCE[1|2]:]FSKey:SOURCE {INTERNAL|EXTERNAL}`

May be Internal (default) or External.

- When the Internal source is selected, the rate at which the output frequency "shifts" between the carrier frequency and hop frequency is determined by the FSK rate. The internal modulating waveform is a 50% duty cycle square wave.
- When the External source is selected, the output frequency is determined by the signal level on the rear-panel **Ext Trig** connector. When a logic low is present, the carrier frequency is output. With a logic high, the hop frequency is output.
- The connector used for externally-controlled FSK waveforms (**Ext Trig**) is not the same connector that is used for externally-modulated AM, FM, PM, and PWM waveforms (**Modulation In**). When used for FSK, the **Ext Trig** connector does not have adjustable edge polarity.

## Pulse Width Modulation (PWM)

This section discusses PWM, which stands for pulse-width modulation. PWM is only available for the Pulse waveform, and the pulse width varies according to the modulating signal. The amount by which the pulse width varies is called the width deviation, and it can be specified as a percentage of the waveform period (that is, duty cycle) or in units of time. For example, if you specify a pulse with 20% duty cycle and then enable PWM with a 5% deviation, the duty cycle varies from 15% to 25% under control of the modulating signal.

The instrument accepts an internal or external modulation source.

### To Select PWM

- You cannot enable PWM when sweep or burst is enabled.
- To avoid multiple waveform changes, enable modulation after configuring the other modulation parameters.
- **Front Panel:**

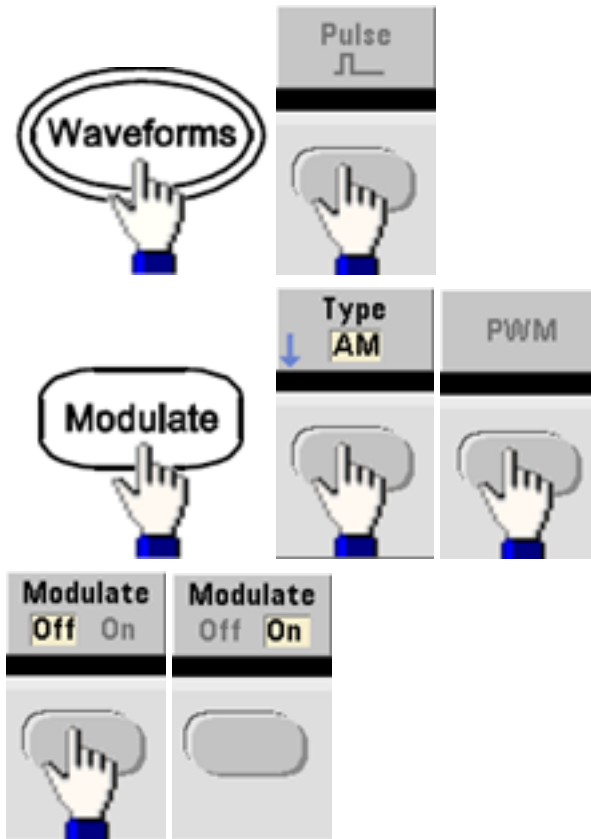





The waveform is output using the present carrier and modulating waveform settings.

- **SCPI:** `[SOURce[1|2]:]PWM:STATe {ON|OFF|0}`

## Modulating Waveform Shape

The instrument accepts an internal or external modulation source.

- The modulating waveform shape (internal source) may be:
  - Sine wave
  - Square with 50% duty cycle 
  - UpRamp with 100% symmetry 
  - Triangle with 50% symmetry 
  - DnRamp with 0% symmetry 
  - Noise - white gaussian noise
  - PRBS - Pseudo Random Bit Sequence (polynomial PN7)
  - Arbitrary waveform
- **Front Panel:**

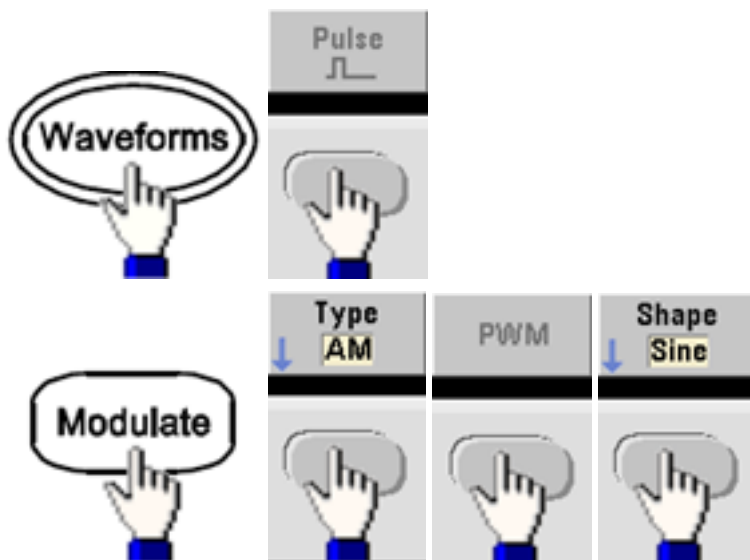

- SCPI: `[SOURce[1|2]:]PWM:INTernal:FUNction <function>`

### Modulating Waveform Frequency

The instrument accepts an internal or external modulation source. The external modulation input has a -3 dB bandwidth of 100 kHz.

- Modulating frequency (internal source): The default is 10 Hz, and the minimum is 1  $\mu$ Hz. The maximum frequency varies by function, model, and output voltage, as shown [here](#).
- Front Panel:



- SCPI: `[SOURce[1|2]:]PWM:INTernal:FREQuency {<frequency>|MINimum|MAXimum|DEFault}`

### Width or Duty Cycle Deviation

The PWM deviation setting is the peak variation in width of the modulated pulse waveform. You can set it in units of time or duty cycle.

- Front Panel:



To set deviation in terms of duty cycle:

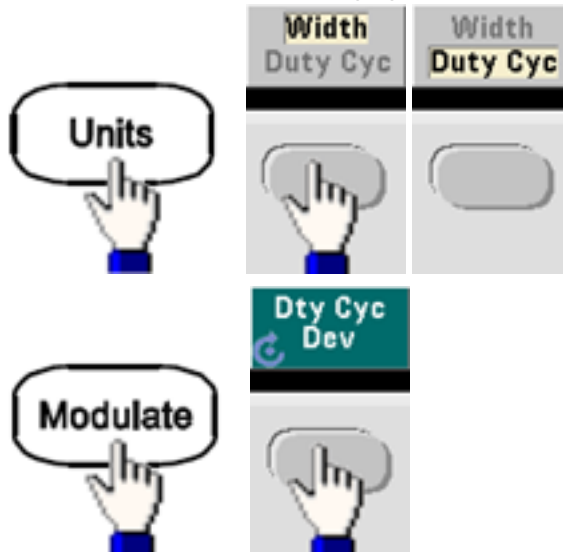

- SCPI: `[SOURce[1|2]:]PWM:DEVIation {<deviation>|MINimum|MAXimum|DEFault}`

- The sum of the pulse width and deviation must satisfy the formula:

$$\text{Pulse Width} + \text{Deviation} < \text{Period} - 16 \text{ ns (33500 Series)}$$

$$\text{Pulse Width} + \text{Deviation} < \text{Period} - 8 \text{ ns (33600 Series above 4 Vpp)}$$

$$\text{Pulse Width} + \text{Deviation} < \text{Period} - 5 \text{ ns (33600 Series up to and including 4 Vpp)}$$

- If necessary, the instrument will adjust the deviation to accommodate the specified period.

## Modulating Source

The instrument accepts an internal or external modulation source.

- Modulating source: Internal (default), Other Channel, or External. The External modulation source may be up to 100 kHz.
- If you select the *External* modulating source, the deviation is controlled by the  $\pm 5$  V signal level (optionally  $\pm 1$  V on the 33600 Series) on the rear-panel **Modulation In** connector. For example, if you have set the deviation to 1  $\mu$ s, then a +5 V signal (optionally + 1 V on the 33600 Series) corresponds to a 1  $\mu$ s increase in width. Lower signal levels produce less deviation.
- **Front Panel:**

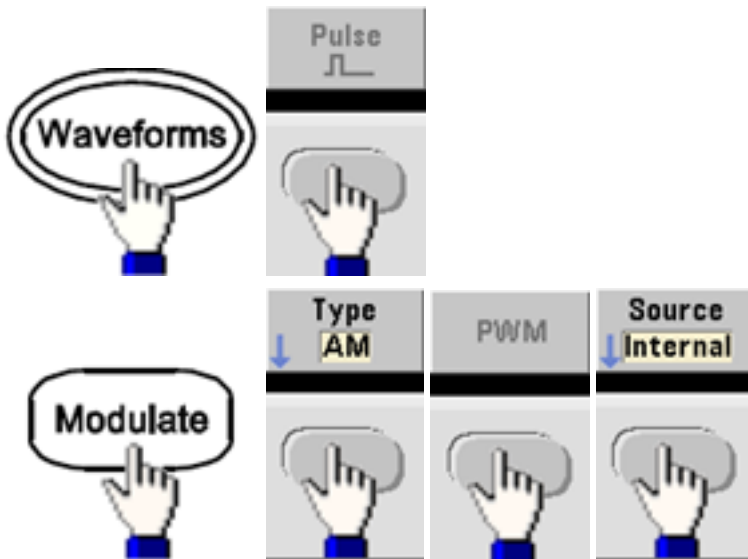

- **SCPI:** `[SOURce[1|2]:]PWM:SOURce {INTernal|EXTernal|CH1|CH2}`

## Pulse Waveform

- Pulse is the only waveform shape supported for PWM.
- **Front Panel:**

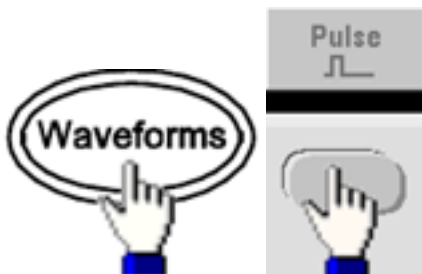

- **SCPI:** `FUNCtion PULSe`
- The **APPLy** command configures a waveform with one command.

## Pulse Period

The range for the pulse period is from the reciprocal of the instrument's maximum frequency up to 1,000,000 s (default 100  $\mu$ s). Note that the waveform period limits the maximum deviation.

- Front Panel:

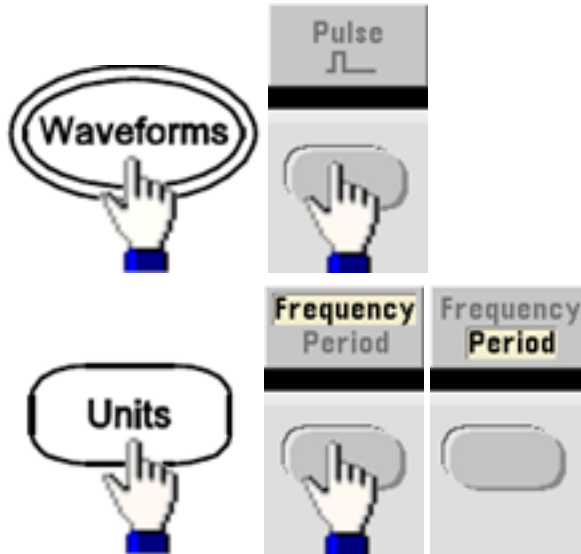

- SCPI: `[SOURce[1|2]:]FUNction:PULSe:PERiod {<seconds>|MINimum|MAXimum|DEFault}`

## Sum Modulation

Sum modulation adds a modulating signal to any carrier waveform; it is typically used to add gaussian noise to a carrier. The modulating signal is added to the carrier as a percentage of carrier waveform amplitude.



### Enable Sum



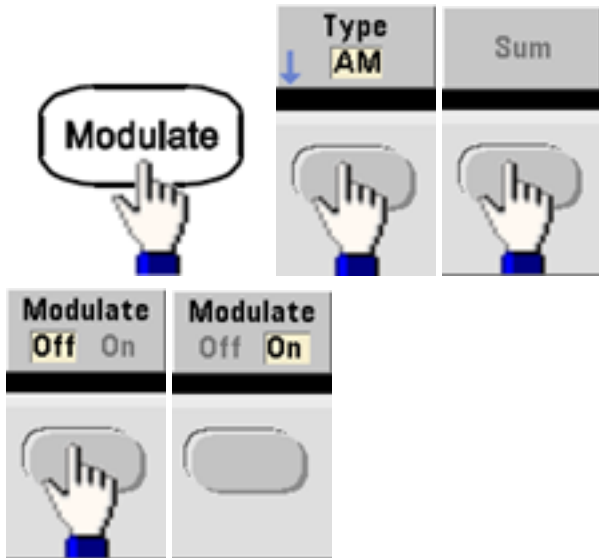

- To avoid multiple waveform changes, enable Sum after configuring other modulation parameters.
- Front Panel:



- SCPI: `[SOURce[1|2]:]SUM:STATe {ON|1|OFF|0}`

### Modulating Waveform Shape

The instrument accepts an internal or external modulation source. On a two-channel instrument you can modulate one channel with the other.

- The modulating waveform shape (internal source) may be:
  - Sine wave
  - Square with 50% duty cycle 
  - UpRamp with 100% symmetry 
  - Triangle with 50% symmetry 
  - DnRamp with 0% symmetry 
  - Noise
  - PRBS with PN7 sequence
  - Arbitrary waveform

- Front Panel:

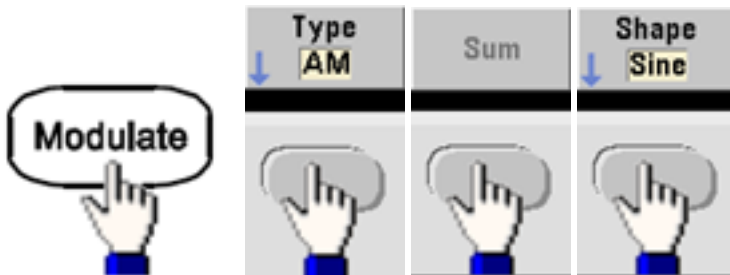

- SCPI: `[SOURCE[1|2]:]SUM:INTernal:FUNCTion <function>`

### Modulating Waveform Frequency

The instrument accepts an internal or external modulation source. On a two-channel instrument you can modulate one channel with the other.

- Modulating frequency (internal source): The default 100 Hz and the minimum is 1  $\mu$ Hz. The maximum frequency varies by function, model, and output voltage, as shown [here](#).

- Front Panel:



- SCPI: `[SOURCE[1|2]:]SUM:INTernal:FREQuency {<frequency>|MINimum|MAXimum|DEFAULT}`

## Sum Amplitude

The Sum Amplitude represents the amplitude of the signal added to the carrier (in percent of carrier amplitude).

- Amplitude setting: 0 to 100% of carrier amplitude, 0.01% resolution.
- Sum Amplitude remains a constant fraction of carrier amplitude and tracks carrier amplitude changes.
- Front Panel:

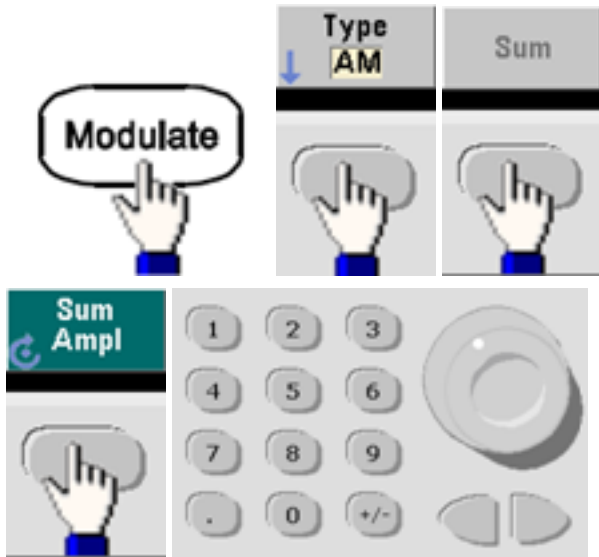

- SCPI: `[SOURCE[1|2]:]SUM:AMPLitude {<amplitude>|MINimum|MAXimum|DEFault}`

## Modulating Source

The instrument accepts an internal or external modulation source. On a two-channel instrument you can modulate one channel with the other.

- Modulating source: Internal (default), Other Channel, or External. The External modulation source may be up to 100 kHz.
- With the external source, the carrier waveform is summed by the  $\pm 5$  V signal level (optionally  $\pm 1$  V on the 33600 Series) on the rear-panel **Modulation In** connector. For example, if you have set the sum amplitude to 10%, then when the modulating signal is at +5 V (optionally +1 V on the 33600 Series), the output will be at the maximum amplitude (110% of carrier amplitude). When the modulating signal is at -5 V (optionally -1 V on the 33600 Series), the output will be at the minimum amplitude (90% of carrier amplitude).

### NOTE

If you are using the other channel as the source for SUM modulation, consider using **the Combine feature** instead. The Combine feature has fewer restrictions and less delay than SUM with other channel.

- **Front Panel:**

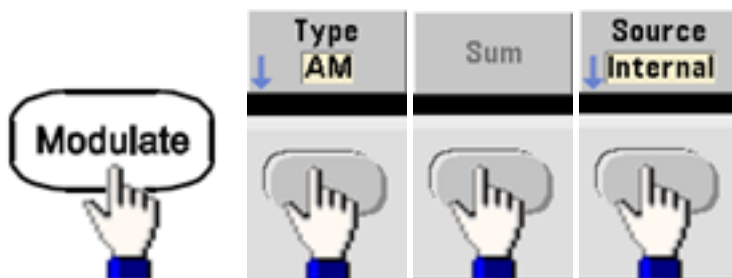

- **SCPI:** `[SOURce[1|2]:]SUM:SOURce {INTernal|EXTernal|CH1|CH2}`

## Frequency Sweep

In frequency sweep mode, the instrument moves from the start frequency to the stop frequency at a specified sweep rate. You can sweep up or down in frequency, with either linear or logarithmic spacing. You can also configure the instrument to output one sweep from start frequency to stop frequency by applying an external or manual trigger. The instrument can sweep sine, square, pulse, ramp, triangle, or arbitrary waveforms (PRBS, noise and DC are not allowed).

You can specify a hold time, during which the sweep remains at the stop frequency, and a return time, during which the frequency changes linearly from the stop frequency to the start frequency.

For more information, see [Frequency Sweep](#).

### To Select Sweep

The instrument will not allow sweep or list mode to be enabled at the same time that burst or any modulation mode is enabled. When you enable sweep, the burst or modulation mode is turned off.

## Operating Information

- To avoid multiple waveform changes, enable the sweep mode after configuring the other parameters.
- **Front Panel:**



- **SCPI:**  
`[SOURCE[1|2]:]FREQuency:MODE SWEEP`  
`[SOURCE[1|2]:]SWEep:STATe {ON|1|OFF|0}`

## Start Frequency and Stop Frequency

The start frequency and stop frequency set the sweep's upper and lower frequency bounds. The sweep begins at the start frequency, sweeps to the stop frequency, and then resets back to the start frequency.

- Start and Stop frequencies: 1  $\mu$ Hz to **maximum frequency for the waveform**. The sweep is phase continuous over the full frequency range. The default start frequency is 100 Hz. The default stop frequency is 1 kHz.
- To sweep up in frequency, set the start frequency less than the stop frequency. To sweep down in frequency, set the opposite relationship.
- Sync setting Normal: **Sync** pulse is high throughout the sweep.
- Sync setting Carrier: **Sync** pulse has a 50% duty cycle for every waveform cycle.
- Sync setting Marker: **Sync** pulse goes high at the beginning and goes low at the marker frequency. You can change this with **OUTPut[1|2]:SYNC:MODE MARKER**.
- **Front Panel:**

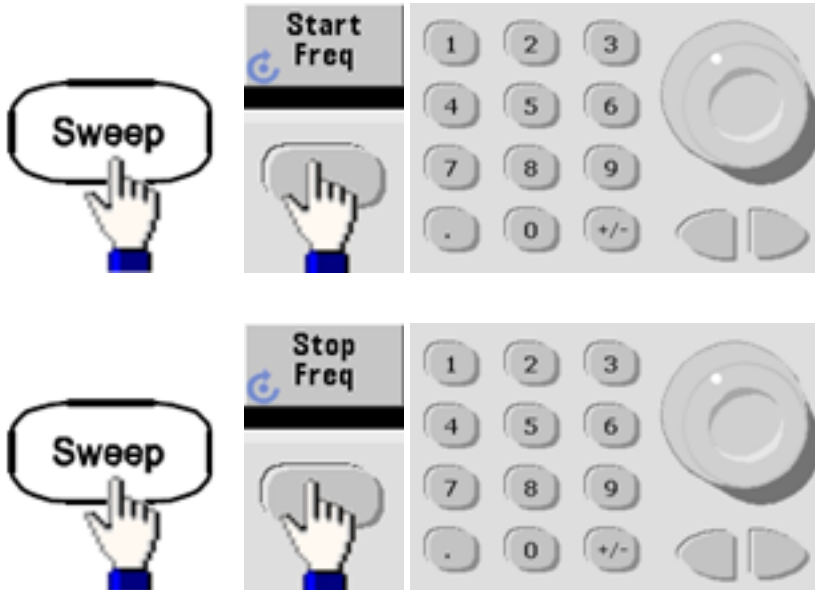

- **SCPI:**  
`[SOURCE[1|2]:]FREQUENCY:START {<frequency>|MINimum|MAXimum|DEFAULT}`  
`[SOURCE[1|2]:]FREQUENCY:STOP {<frequency>|MINimum|MAXimum|DEFAULT}`

## Center Frequency and Frequency Span

You can also set the sweep frequency boundaries of the sweep using a center frequency and frequency span. These parameters are similar to the start frequency and stop frequency (above) and they provide added flexibility.

- Center frequency: 1  $\mu$ Hz to **maximum frequency for the waveform**. The default is 550 Hz.
- Frequency span: Any value between  $\pm$ **maximum frequency for the waveform**. The default is 900 Hz.
- To sweep up in frequency, set a positive frequency span; to sweep down, set a negative frequency span.
- Sync setting Normal: **Sync** pulse is high throughout the sweep.
- Sync setting Carrier: **Sync** pulse has a 50% duty cycle for every waveform cycle.
- Sync setting Marker: **Sync** pulse goes high at the beginning and goes low at the marker frequency. You can change this with **OUTPut[1|2]:SYNC:MODE MARKER**.
- **Front Panel:**

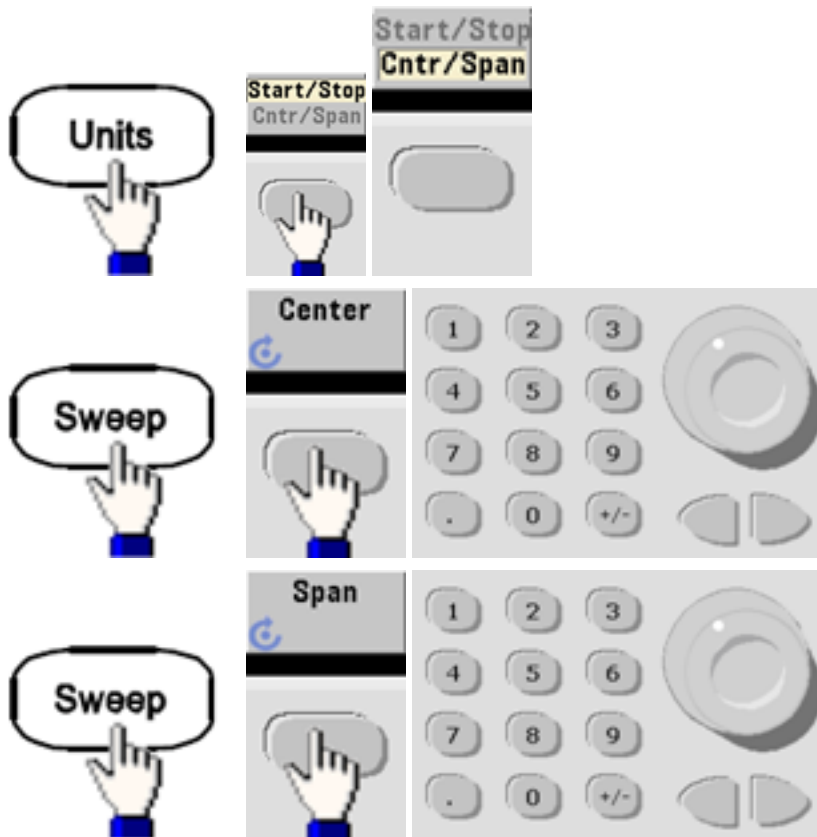

- **SCPI:**  
`[SOURce[1|2]:]FREQuency:CENTer {<frequency>|MINimum|MAXimum|DEFault}`  
`[SOURce[1|2]:]FREQuency:SPAN {<frequency>|MINimum|MAXimum|DEFault}`

## Sweep Mode

You can sweep with linear or logarithmic spacing, or with a list of sweep frequencies. For a linear sweep, the instrument varies the output frequency linearly during the sweep. A logarithmic sweep varies the output frequency logarithmically.

The selected mode does not affect the sweep return (from stop to start, if one is set). The sweep return is always linear.

- Front Panel:

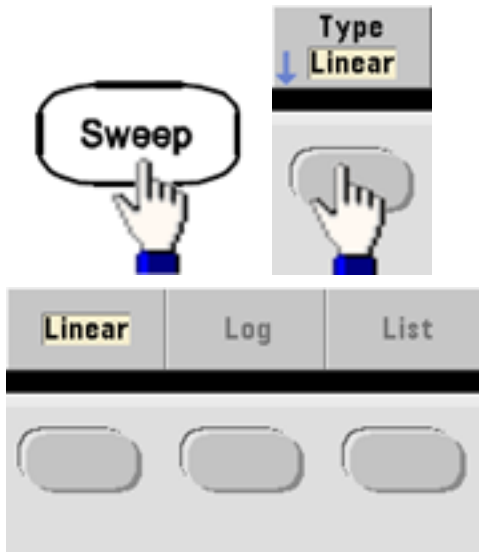

- SCPI: `[SOURCE[1|2]:]SWEep:SPACing {LINear|LOGarithmic}`

## Sweep Time

Sweep time specifies the number of seconds required to sweep from the start frequency to the stop frequency. The instrument calculates the number of points in the sweep based on the sweep time.

- Sweep time: 1 ms to 250,000 seconds, default 1 s. For a linear sweep in immediate trigger mode, the maximum total sweep time (including hold time and return time) is 8,000 s. The maximum total sweep time for linear sweeps using other trigger modes is 250,000 s; the maximum total sweep time for logarithmic sweeps is 500 s.
- Front Panel:



- SCPI: `[SOURCE[1|2]:]SWEep:TIME {<seconds>|MINimum|MAXimum|DEFault}`



## Hold/Return Time

Hold time specifies time (in seconds) to remain at the stop frequency, and return time specifies the number of seconds to return from the stop frequency to the start frequency.

- Hold time and return time: 0 to 3600 seconds (default 0).

- Front Panel:

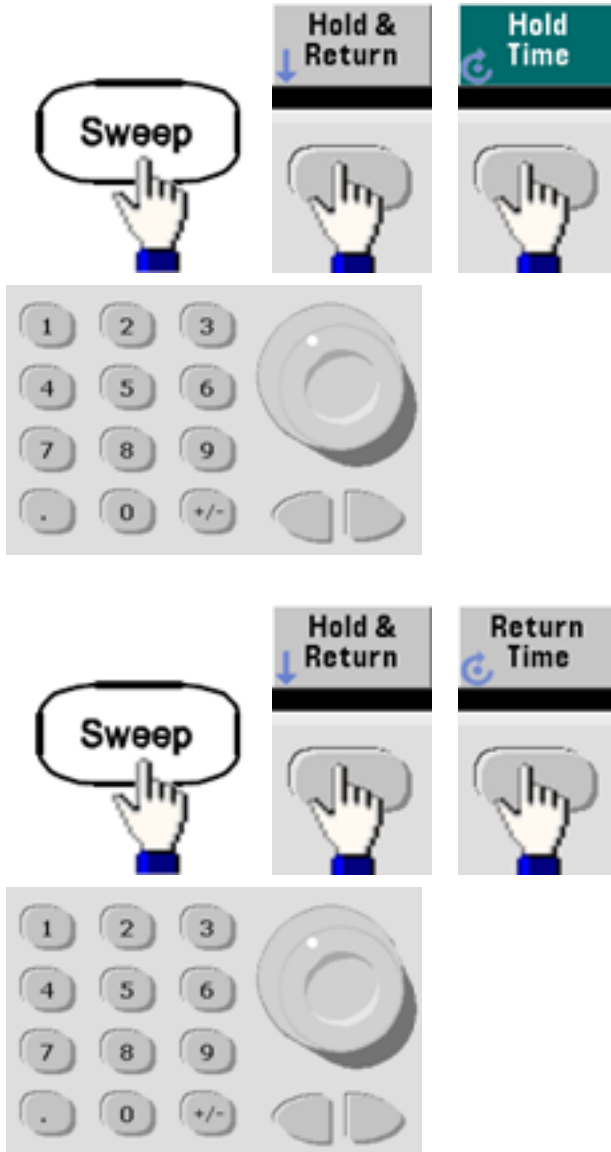

- SCPI:

`[SOURCE[1|2]:]SWEep:HTIME {<hold_time>|MINimum|MAXimum|DEFAULT}`

`[SOURCE[1|2]:]SWEep:RTIME {<return_time>|MINimum|MAXimum|DEFAULT}`

## Marker Frequency

If desired, you can set the frequency at which the signal on the front panel **Sync** connector goes to a logic low during the sweep. The **Sync** signal always goes from low to high at the beginning of the sweep.

- Marker frequency: 1  $\mu$ Hz to **maximum frequency for the waveform**. The default is 500 Hz.
- When the sweep mode is enabled, the marker frequency must be between the specified start frequency and stop frequency. If you attempt to set the marker frequency to a frequency not in this range, the instrument will set the marker frequency equal to the start frequency or stop frequency (whichever is closer).
- You cannot configure the marker frequency with the front panel menus unless the **Sync** source is the sweeping channel.
- **Front Panel:**

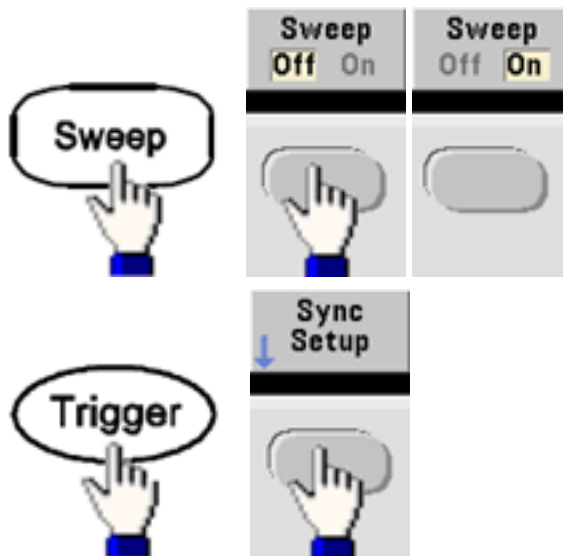

- **SCPI:** `[SOURCE[1|2]:]MARKer:FREQuency {<frequency>|MINimum|MAXimum|DEFault}`

## Sweep Trigger Source

In sweep mode, the instrument outputs a single sweep when a trigger signal is received. After one sweep from the start frequency to the stop frequency, the instrument waits for the next trigger while outputting the start frequency.

- Sweep trigger source: Immediate (default), External, Time, or Manual.
- With the Immediate (internal) source, the instrument outputs a continuous sweep at a rate determined by the total of the hold time, sweep time and return time. The sweep time for this source is limited to 8000 seconds.
- With the External source, the instrument accepts a hardware trigger on the rear-panel Ext Trig connector and initiates one sweep each time Ext Trig receives a TTL pulse with the specified polarity.
- The trigger period must be greater than or equal to the specified sweep time.
- With the Manual source, the instrument outputs one sweep each time the front panel **[Trigger]** key is pressed.
- **Front Panel:**



- To specify the slope of the trigger signal edge:



- **SCPI:**  
`TRIGger[1|2]:SOURce {IMMediate|EXTernal|TIMer|BUS}`  
  
`TRIGger[1|2]:SLOPe {POSitive|NEGative}`

See [Triggering](#) for more information.

## Trigger Out Signal

A "trigger out" signal is provided on the rear-panel **Ext Trig** connector (used with burst and sweep only). When enabled, a pulse with either a rising edge (default) or falling edge is output from this connector at the beginning of the sweep or burst.

- When the Immediate (internal) trigger source is selected, the instrument outputs a square waveform with a 50% duty cycle from the **Ext Trig** connector at the beginning of the sweep or burst. The frequency of the waveform corresponds to the specified burst period or total sweep time.
- When the External trigger source is selected, the instrument disables the "trigger out" signal. The **Ext Trig** connector cannot be used for sweep or burst and trigger out at the same time (an externally-triggered waveform uses the same connector to trigger the sweep or burst).
- When Manual or bus (software) trigger source is selected, the instrument outputs a pulse (>1  $\mu$ s pulse width on the 33500 Series and 100 ns on the 33600 Series) from the **Ext Trig** connector at the beginning of each sweep or burst.
- To specify whether the instrument triggers on the rising or falling edge on the **Ext Trig** connector, press **[Trigger] > Trig Out Setup**. Then select the desired edge by pressing **Trig Out**.
- **SCPI:**  
`OUTPut:TRIGger:SLOPe {POSitive|NEGative}`  
  
`OUTPut:TRIGger {ON|1|OFF|0}`

## Frequency List

In frequency list mode, the instrument "steps" through a list of frequencies, dwelling on each frequency for a specified period. You may also control progress through the list with triggering.

- The instrument will not allow sweep or list mode to be enabled at the same time that burst or any modulation mode is enabled. When you enable sweep, the burst or modulation mode is turned off.
- To avoid multiple waveform changes, enable list mode after configuring its parameters.
- **Front Panel:** Enable list before setting any other list parameter. Press **[Sweep] > Type > List**.
- **SCPI:**  
`[SOURcd[1|2]:]FREQuency:MODE LIST`  
  
`[SOURce[1|2]:]LIST:FREQuency <freq1>[, <freq2>, etc.]`
- Progress through list is controlled by the trigger system. If trigger source is internal or immediate, the dwell time setting (**LIST:DWELL**) determines time spent at each frequency. For any other trigger source, dwell time is determined by trigger event spacing.

## Burst Mode

The instrument can output a waveform for a specified number of cycles, called a burst. Burst is allowed with sine, square, triangle, ramp, pulse, PRBS, or arbitrary waveforms (noise is allowed only in gated burst mode; DC is not allowed).

For details, see [Tutorial - Burst](#).

### To Select Burst

Burst cannot be enabled when sweep or modulation is enabled. Enabling burst turns off sweep and modulation.

- To avoid multiple waveform changes, enable burst mode after configuring other parameters.

- Front Panel:



- SCPI: `[SOURCE[1|2]:]BURSt:STATe {ON|OFF}`

## Burst Mode

Burst has two modes, described below. Selected mode controls allowable trigger source, and which other burst parameters apply.

- **Triggered Burst Mode (default):** The instrument outputs a waveform for specified number of cycles (burst count) each time trigger is received. After outputting specified number of cycles, instrument stops and waits for next trigger. The instrument can use an internal trigger to initiate burst, or you can provide external trigger by pressing the front panel **[Trigger]** key, applying trigger signal to rear-panel **Ext Trig** connector, or sending software trigger command from remote interface.
- **External Gated Burst Mode:** Output waveform is on or off, based on level of external signal applied to rear-panel **Ext Trig** connector. When the gate signal is true, the instrument outputs a continuous waveform. When the gate signal goes false, the current waveform cycle is completed and the instrument stops while remaining at the voltage level corresponding to the starting burst phase of the selected waveform. The noise waveform output stops immediately when the gate signal goes false.

Parameter	Burst Mode (BURS:MODE)	Burst Count (BURS:NCYC)	Burst Period (BURS:INT:PE-R)	Burst Phase (BURS:PHAS)	Trigger Source (TRIG:SOUR)
Triggered Burst Mode: Internal Trigger	TRIGgered	Available	Available	Available	IMMediate
Triggered Burst Mode: External Trigger	TRIGgered	Available	Not Used	Available	EXTernal, BUS
Gated Burst Mode: External Trigger	GATed	Not Used	Not Used	Available	Not Used
Timer Burst Mode: Internal Trigger	TRIGgered	Available	Not Used	Available	TIMer

- In gated mode, burst count, burst period, and trigger source are ignored (used for triggered burst only). Manual triggers ignored; no error generated.
- In gated mode, you can specify polarity of signal on the rear-panel **Ext Trig** connector (**[SOURce [1|2]:BURSt:GATE:POLarity {NORMAL|INVERTed}]**). Default is NORMAL (true-high).

## Operating Information

- Front Panel:

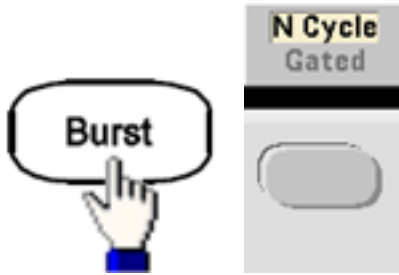

- SCPI: `[SOURce[1|2]:]BURSt:MODE {TRIGgered|GATed}`

## Waveform Frequency

You can specify the signal frequency during the burst in triggered and external gated modes. In the triggered mode, the number of cycles specified by the burst count is output at the waveform frequency. In the external gated mode, the waveform frequency is output when the external gate signal is true.

This differs from the "burst period," which specifies interval between bursts (triggered mode only).

- Waveform frequency: 1  $\mu$ Hz to **maximum frequency of the waveform**. The default value is 1 kHz. (For an internally triggered burst waveform, the minimum frequency is 126  $\mu$ Hz in the 33500 Series or 251  $\mu$ Hz in the 33600 Series.)

- Front Panel:

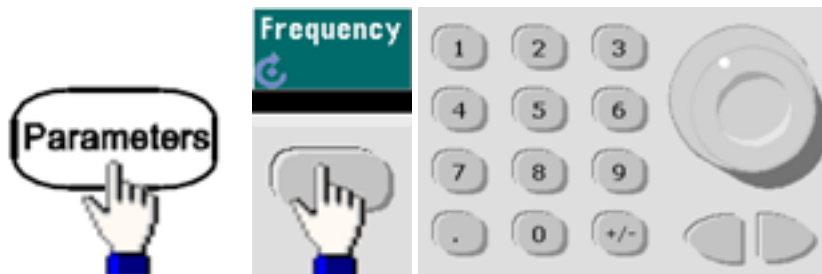

- SCPI: `[SOURce[1|2]:]FREQuency {<frequency>|MINimum|MAXimum|DEFault}`

The **APPLY** command configures a waveform with one command.

## Burst Count

Number of cycles (1 to 100,000,000 or infinite) to be output per burst. Used in the triggered burst mode only (internal or external source).

- With the Immediate trigger source, the specified number of cycles are output continuously at a rate determined by the burst period. The burst period is the time between the starts of consecutive bursts. Also, the burst count must be less than the product of burst period and waveform frequency:

$$\text{Burst Period} > (\text{Burst Count}) / (\text{Waveform Frequency}) + 1 \mu\text{sec (33500 Series)}$$

$$\text{Burst Period} > (\text{Burst Count}) / (\text{Waveform Frequency}) + 500 \text{ ns (33600 Series)}$$

- The instrument will increase burst period to its maximum value to accommodate specified burst count (but waveform frequency will not be changed).
- In gated burst mode, burst count is ignored. However, if you change the burst count from the remote interface while in the gated mode, the instrument remembers the new count and will use it when the triggered mode is selected.

- **Front Panel:**

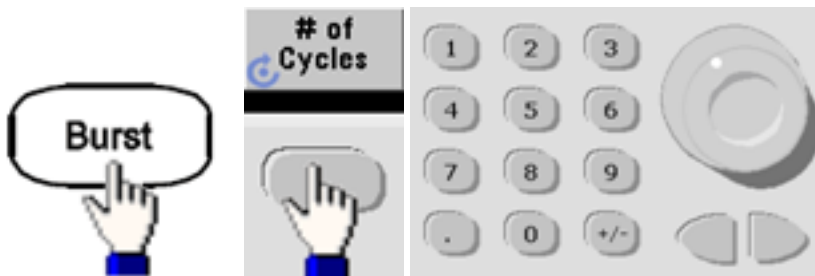

or



- **SCPI:** `[SOURce[1|2]:]BURSt:NCYCles {<num_cycles>|INFinity|MINimum|MAXimum}`



## Burst Period

Burst period, which is used in internal triggered burst mode only, is the time from the start of one burst to the start of next burst (1  $\mu$ s to 8000 s, default 10 ms for the 33500 Series). On the 33600 Series, the range is from 1  $\mu$ s to 4000 s, and the default is also 10 ms. Burst period differs from "waveform frequency," which specifies the frequency of the bursted signal.

- Burst period is used only when Immediate triggering is enabled. The burst period is ignored when manual or external triggering is enabled (or when the gated burst mode is selected).
- You cannot specify a burst period that is too short for the instrument to output with the specified burst count and frequency. If the burst period is too short, the instrument will increase it as needed to continuously re-trigger the burst.

- **Front Panel:**

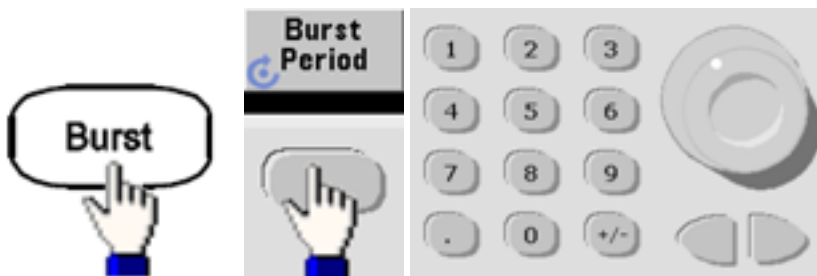

- **SCPI:** `[SOURce[1|2]:]BURSt:INTernal:PERiod {<seconds>|MINimum|MAXimum}`

## Start Phase

Start phase of the burst, from -360 to +360 degrees (default 0).

- Specify the start phase units with **UNIT:ANGLE**.
- Always displayed in degrees on front panel (never radians). If set in radians from remote interface, instrument converts value to degrees on the front panel.
- For sine, square, and ramp, 0 degrees is the point at which the waveform crosses 0 V (or DC offset) in a positive-going direction. For arbitrary waveforms, 0 degrees is the first waveform point. Start phase has no effect on noise.
- Start phase also used in gated burst mode. When the gate signal goes false, the current waveform cycle finishes, and output remains at the voltage level of the starting burst phase.

- **Front Panel:**



- **SCPI:** `[SOURce[1|2]:]BURSt:PHASe {<angle>|MINimum|MAXimum}`

## Burst Trigger Source

In triggered burst mode:

- The instrument outputs a waveform of the specified number of cycles (burst count) when a trigger is received. After the specified number of cycles have been output, the instrument stops and waits for next trigger.
- **IMMEDIATE (internal)**: the instrument outputs continuously when burst mode is enabled. The rate at which the burst is generated is determined by **BURSt:INTernal:PERiod**.
- **EXTernal**: the instrument accepts a hardware trigger at the rear-panel **Ext Trig** connector. The instrument outputs one burst of the specified number of cycles each time **Ext Trig** receives a level transition with the proper polarity (**TRIGger[1|2]:SLOPe**). External trigger signals during a burst are ignored.
- **BUS (software)**: the instrument initiates one burst each time a bus trigger (**\*TRG**) is received. The front panel **[Trigger]** key is illuminated when the instrument is waiting for a bus trigger.
- **EXTernal or BUS**: burst count and burst phase remain in effect, but burst period is ignored.
- **TIMer**: trigger events are spaced by a timer, with the first trigger as soon as **INIT** occurs.
- **Front Panel:**



- To specify whether the instrument triggers on a rising or falling edge of the signal at the Ext Trig connector, select the external trigger source before choosing **Trigger Setup**.
- **SCPI:**  
**TRIGger[1|2]:SOURce {IMMEDIATE|EXTernal|TIMer|BUS}**  
  
**TRIGger[1|2]:SLOPe {POSitive|NEGative}**

See **Triggering** for more information.

### NOTE

If the duty cycle is changed on a triggered bursted square wave with the trigger mode set to Timer, the current burst will finish and one more burst will be executed before the duty cycle of the burst changes.

## Trigger Out Signal

A "trigger out" signal is provided on the rear-panel **Ext Trig** connector (used with burst and sweep only). When enabled, a pulse with either a rising edge (default) or falling edge is output from this connector at the beginning of the sweep or burst.

- When the Immediate (internal) trigger source is selected, the instrument outputs a square waveform with a 50% duty cycle from the **Ext Trig** connector at the beginning of the sweep or burst. The frequency of the waveform corresponds to the specified burst period or total sweep time.
- When the External trigger source is selected, the instrument disables the "trigger out" signal. The **Ext Trig** connector cannot be used for sweep or burst and trigger out at the same time (an externally-triggered waveform uses the same connector to trigger the sweep or burst).
- When Manual or bus (software) trigger source is selected, the instrument outputs a pulse (>1  $\mu$ s pulse width on the 33500 Series and 100 ns on the 33600 Series) from the **Ext Trig** connector at the beginning of each sweep or burst.
- **Front Panel**



Then use this softkey to choose the desired edge direction:



- **SCPI:**  
`OUTPut:TRIGger:SLOPe {POSitive|NEGative}`  
`OUTPut:TRIGger {ON|1|OFF|0}`

## Triggering

This section describes the instrument's triggering system.

### Trigger Overview

This triggering information applies to sweep and burst only. You can issue triggers for sweeps or bursts using internal triggering, external triggering, timer triggering, or manual triggering.

- Internal or "automatic" (default): instrument outputs continuously when sweep or burst mode is selected.
- External: uses rear-panel **Ext Trig** connector to control sweep or burst. The instrument initiates one sweep or outputs one burst each time **Ext Trig** receives a pulse. You can select whether instrument triggers on rising or falling edge.
- Manual: triggering initiates one sweep or outputs one burst each time you press **[Trigger]** on the front panel.
- When you sweep a list, trigger moves the waveform to the next frequency in the list.
- The **[Trigger]** key is disabled when in remote and when a function other than burst or sweep is currently selected.

### Trigger Sources

This triggering information applies to sweep and burst only. You must specify the source from which the instrument accepts a trigger.

- Sweep and Burst trigger source: Immediate (default), External, Manual or Timer.
- The instrument will accept a manual trigger, a hardware trigger from the rear-panel **Ext Trig** connector, or continuously output sweeps or bursts using an internal trigger. You can also trigger bursts based on a timer. At power-on, immediate trigger is selected.
- Trigger source setting is volatile; set to internal trigger (front panel) or immediate (remote interface) by power cycle or **\*RST**.
- **Front Panel:**  
Enable sweep or burst. Then:



- **SCPI:TRIGger[1|2]:SOURce {IMMediate|EXTernal|TIMer|BUS}**
- The **APPLY** command automatically sets the source to Immediate.

### Immediate Triggering

Internal trigger mode (default): instrument continuously outputs sweep or burst (as specified by sweep time or burst period).

Front Panel:



SCPI: **TRIGger:SOURce IMMEDIATE**

### Manual Triggering

Manual trigger mode (front panel only): you manually trigger the instrument by pressing **[Trigger]**. The instrument initiates one sweep or burst for each time you press **[Trigger]**. The button is lit when you are in the trigger menu and the instrument is waiting for a manual trigger. The button blinks when the instrument is waiting for a manual trigger, but you are not in the trigger menu. The key is disabled when the instrument is in remote.

### External Triggering

In external trigger mode, the instrument accepts a hardware trigger at the rear-panel **Ext Trig** connector. The instrument initiates one sweep or burst each time Ext Trig receives a TTL pulse with the specified edge. The external trigger mode is like the manual trigger mode except that you apply the trigger to the **Ext Trig** connector.

See [Trigger Input Signal](#), below.

Front Panel:



To specify whether the instrument triggers on a rising or falling edge, press **Trigger Setup** and select the edge direction by pressing **Slope**.

SCPI:

**TRIGger:SOURce EXTERNAL**

**TRIGger[1|2]:SLOPe {POSitive|NEGative}**

## Software (Bus) Triggering

Available only from remote interface, this is similar to manual trigger mode from the front panel, but you trigger the instrument with a bus trigger command. The instrument initiates one sweep or outputs one burst each time a bus trigger command is received. The key blinks when a bus trigger command is received.

To select the bus trigger source, send **TRIGger:SOURce BUS**.

To trigger instrument from remote interface (GPIB, USB, or LAN) when Bus source is selected, send **TRIG** or **\*TRG** (trigger). The front panel [**Trigger**] key is illuminated when the instrument is waiting for a bus trigger.

## Timer Triggering

The timer trigger mode issues triggers a fixed period apart. To select the bus trigger source, send **TRIGger:SOURce TIMer**.

## Trigger Input Signal

This rear-panel connector is used in the following modes:

- Triggered Sweep Mode: Press **Trigger Setup > Source Ext**, or execute **TRIG:SOUR EXT** (sweep must be enabled). When a level transition of the correct polarity is received on the **Ext Trig** connector, instrument outputs a single sweep.
- Externally-Modulated FSK Mode: Press **Source** or execute **FSK:SOUR EXT** (FSK must be enabled). When a low level is present, carrier frequency is output. When a high level is present, hop frequency is output. Maximum external FSK rate is 100 kHz.
- Triggered Burst Mode: Press **Trigger Setup > Source Ext**, or execute **TRIG:SOUR EXT** (burst must be enabled). The instrument outputs a waveform with specified number of cycles (burst count) each time a trigger is received from the specified trigger source.
- External Gated Burst Mode: Press **Gated** softkey or execute **BURS:MODE GAT** with burst enabled. When external gate signal is true, instrument outputs a continuous waveform. When external gate signal goes false, the current waveform cycle completes and then instrument stops while remaining at voltage level corresponding to starting burst phase. For noise, output stops as soon as the gate signal goes false.

## Trigger Output Signal

**CAUTION** The trigger output signal is chassis referenced, and it is physically next to the external modulation input, which is floating. Use appropriate care not to touch the two signals simultaneously as you are connecting or disconnecting these cables. De-energize connections to the instrument output before connecting or disconnecting these cables.

- A "trigger out" signal is provided on the rear-panel **Ext Trig** connector (used with burst and sweep only). When enabled, a pulse with either a rising edge (default) or falling edge is output from this connector at the beginning of the sweep or burst.

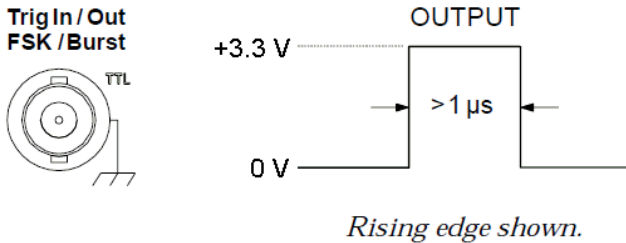

**NOTE**

The diagram above shows the triggering on the 33500 Series. On the 33600 Series, the pulse width is 100 ns, and the voltage level is programmable (not necessarily the +3.3 V shown). See **TRIGger:LEVel** for details on how to set this value.

- **Internal (immediate) or Timer trigger source:** instrument outputs a square wave with a 50% duty cycle from the **Ext Trig** connector at the beginning of the sweep or burst. Waveform period equals specified sweep time or burst period.
- **External trigger source:** instrument disables "trigger out" signal. The rear-panel **Ext Trig** connector cannot be used for both operations simultaneously (an externally-triggered waveform uses the same connector to trigger sweep or burst).
- **Bus (software) or manual trigger source:** instrument outputs a pulse (>1 μs pulse width) from **Ext Trig** connector at beginning of each sweep or burst.
- **Front Panel:** Enable sweep or burst. Then:



Then use this softkey to choose the desired edge direction:



- **SCPI:**  
 OUTPut:TRIGger:SLOPe {POSitive|NEGative}  
  
 OUTPut:TRIGger {ON|1|OFF|0}

## Dual Channel Operations

This section covers most topics related to dual channel operation. It does not cover the **optional IQ Player**.

### Entering Dual Channel Operation

You enter dual channel configuration by pressing a channel output button, then **More**, then **Dual Channel**.

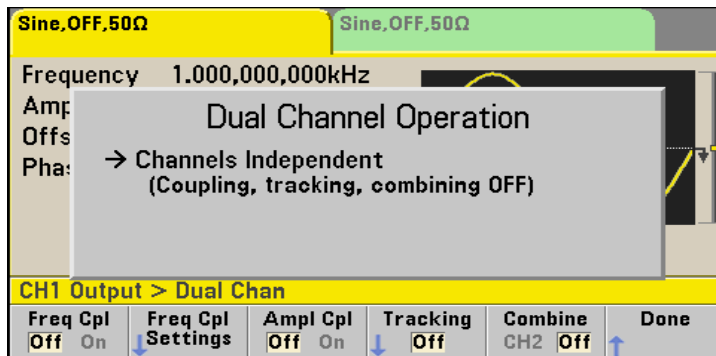

### Frequency Coupling

Frequency coupling allows you to couple frequencies or sample rates between channels, either by a constant ratio or offset between them. Press **Freq Cpl** to turn frequency coupling on or off, and press **Freq Cpl Settings** to configure frequency coupling.

The **Freq Cpl Settings** softkey opens the menu shown below. The first softkey allows you to specify whether you want to couple the frequencies with a ratio or an offset, and the second softkey allows you to specify the ratio or offset.

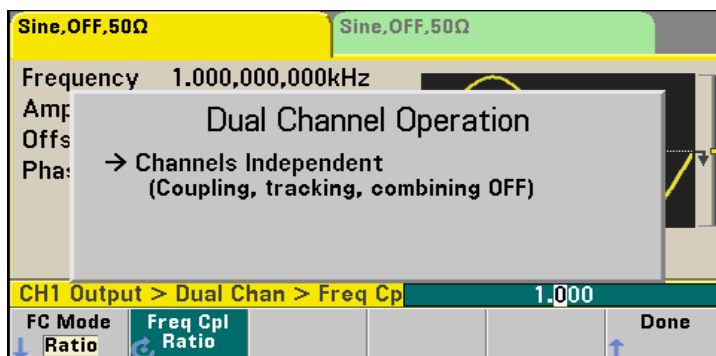

### Amplitude Coupling

Amplitude coupling, enabled by the **Ampl Cpl** softkey, couples the amplitude and offset voltage between the channels so that changing the amplitude or offset on one channel affects both channels.



## Tracking

Tracking, configured by the **Tracking** softkey, has three modes: **Off**, **On** and **Invert**. When tracking is off, the two channels operate independently. When tracking is on, they behave as one channel. The third mode, **Invert**, makes the channels' outputs inverses of each other, resulting in a differential channel using both outputs.

## Combine

The **Combine** feature combines two outputs into one connector. If you choose **CH2** from the **Channel 1** menu, they are combined on channel 1; choosing **CH1** from the **Channel 2** menu combines them on channel 2.

In the image below, the top waveform is a 100 mVpp, 1 kHz sine wave on channel 1, and the bottom waveform is a 100 mVpp, 5 kHz sine wave on channel 2.

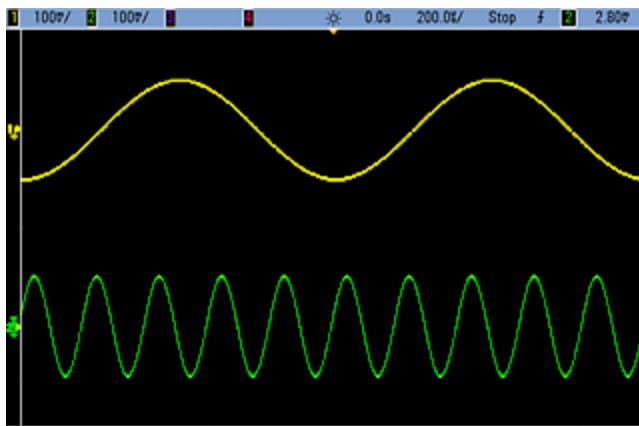

The image below shows the two outputs combined on channel 1. Note that the X-axis has been compressed (zoomed out) to show more cycles.

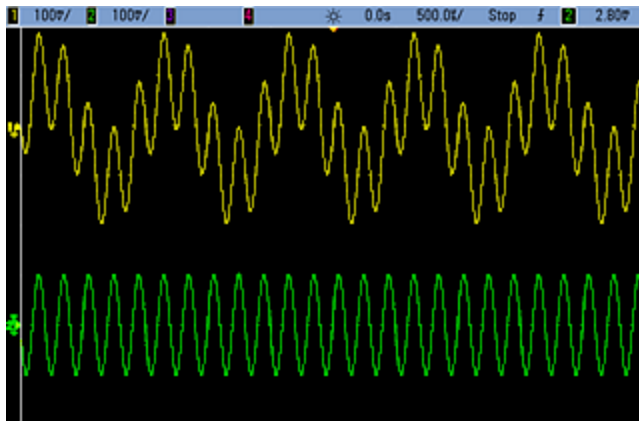

The signals being combined do not have to be of the same type; for example, this image shows the same 5 kHz channel on channel 2 combined with a 100 mVpp square wave on channel 1.

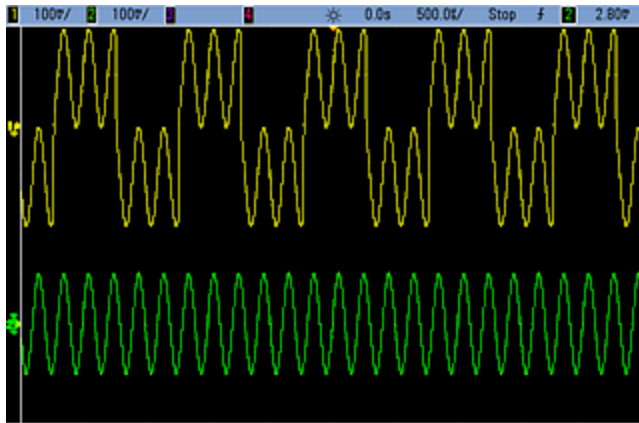

When signals are combined, the DC Offset values are not added together. Only the DC Offset from the receiving channel is used in the combined output. The figure below shows 50 mV DC Offset added to Channel 1. The 50 mV offset added to Channel 2 is ignored.

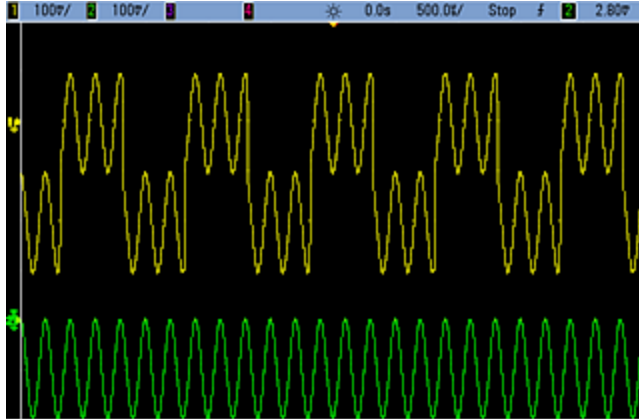

You may also use **Combine** with bursts. For example, consider the image below, which includes a 1 kHz sine wave on channel 1 and three-cycle bursts of a 5 kHz sine wave on channel 2.

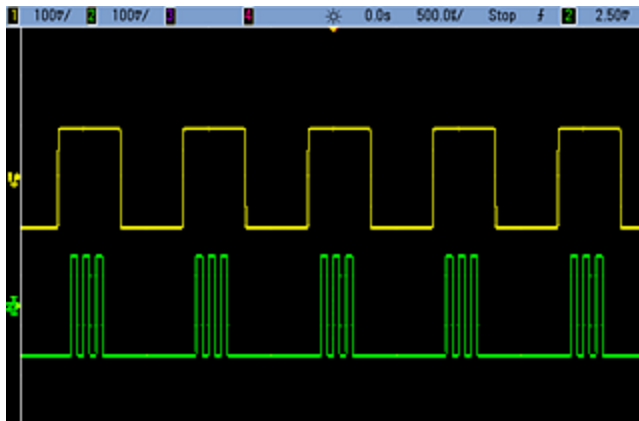

## Operating Information

When these signals are combined on channel 1, the result is a simple amplitude addition of the two signals, as shown below.

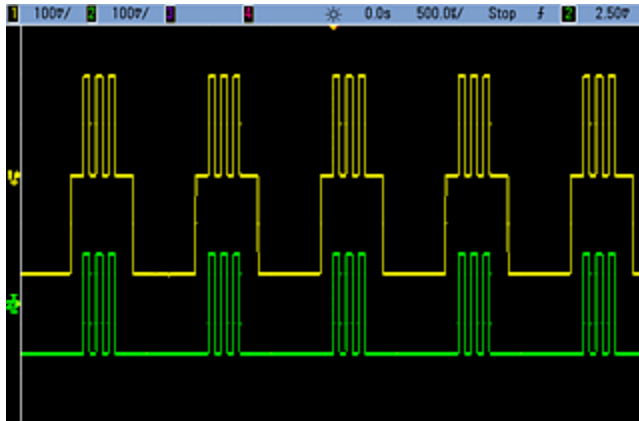

You also can combine the signals on channel 2, as shown below.

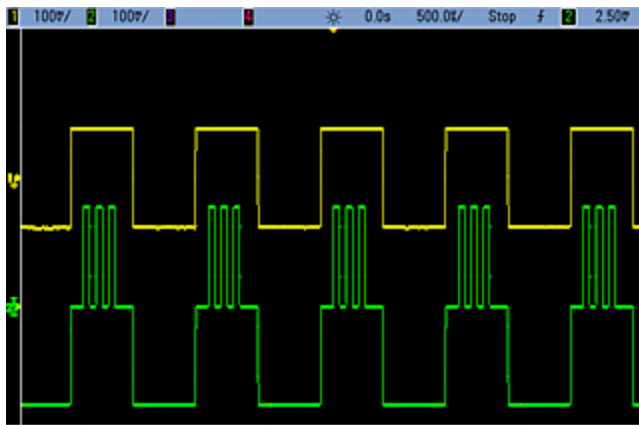

## IQ Player (Optional)

The **optional IQ Player** is used to play dual arbitrary waveforms, such as IQ baseband signals.

A dual arbitrary waveform is analogous to a stereo music file. It has two channels of information that contain the same number of samples, always start and end together, and always play at the same sample rate.

### File Formats

The instrument's native **.ARB** and **.BARB** files can contain either one or two channels of data. These files are typically created in **Keysight BenchLink Waveform Builder** software, and you can directly play them on the instrument.

You can also directly play files ending in **.DAT**, **.ASC**, **.I**, and **.Q**. These file formats contain one or two columns of ASCII numbers ranging between -1.0 and 1.0, in either scientific or decimal notation. The data represents the relative "shape" of the waveform at the current amplitude range.

Finally, you can import one- or two-column data files in .CSV or .TXT format. To import a file, press **[Waveforms] > Arb > Arb > Import Data**. This opens a menu interface that quickly guides you through the process of importing a file.

### Front Panel

Once you have a dual arbitrary waveform as the active waveform, the tab changes to a purple color, as shown below.

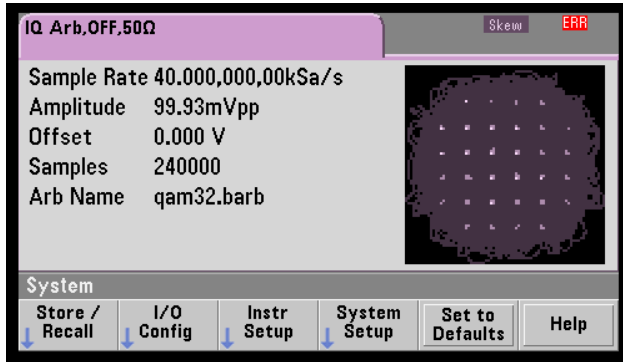

The waveform image is a constellation diagram, but you can change it to a time domain diagram. To do this, press **[System] > System Setup > Screen Layout**. This takes you to the following menu:



Pressing the **Time** softkey changes the graphic to a time domain image:

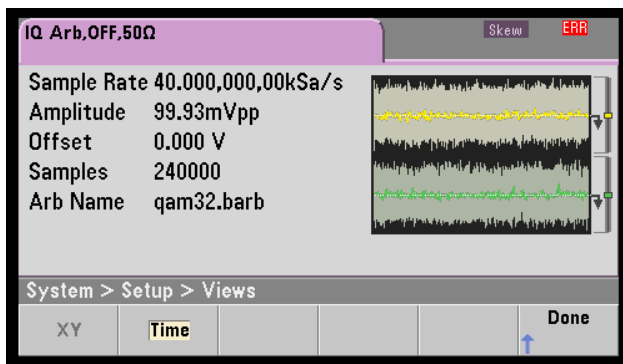

## Operating Information

### Balance Adjust

If you press **More** from the [Parameters] menu, you will go to page 2 of the [Parameters] menu:

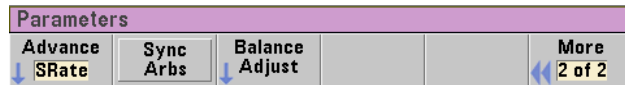

From this menu, you can press **Balance Adjust** to open a menu that will allow you specify the balance amplitude gain and channel offsets:

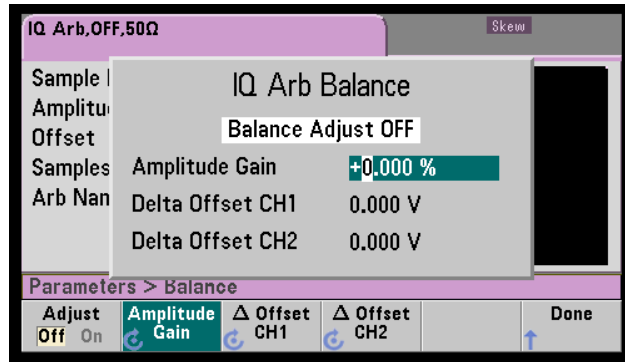

### IQ Arb Skew

To compensate for minor channel-channel time skew, begin by pressing either of the channel output buttons and then pressing **More** to go to page 2 of the menu:

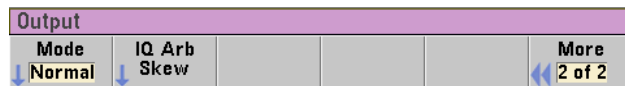

On this menu, press **IQ Arb Skew** to open the following menu, which allows you to compensate for up to 4 ns of skew on the 33500 Series or 1 ns of skew on the 33600 Series:

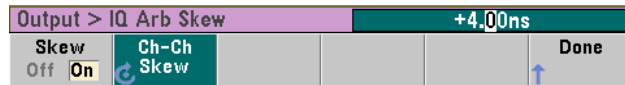

## SCPI Commands

There are eight SCPI commands associated with the IQ Player:

### Loading Dual Arbitrary Waveforms

```
[SOURce[1|2]:]DATA:ARbitrary[1|2] <arb_name>, {<binary_block>|<value>, <value>, ...}
```

```
[SOURce[1|2]:]DATA:ARbitrary[1|2]:DAC <arb_name>, {<binary_block>|<value>, <value>, ...}
```

```
[SOURce[1|2]:]DATA:ARbitrary2:FORMat {AABB|ABAB}
```

### Adjusting Playback of Dual Arbitrary Waveforms

```
FUNction:ARbitrary:BALance:GAIN {<percent>|MINimum|MAXimum|DEFine}
```

```
FUNction:ARbitrary:BALance:OFFSet{1|2} {<volts>|MINimum|MAXimum|DEFault}
```

```
FUNction:ARbitrary:BALance[::STATe] {ON|1|OFF|0}
```

```
FUNction:ARbitrary:SKEW[::STATe] {ON|1|OFF|0}
```

```
FUNction:ARbitrary:SKEW:TIME [{<time>|MINimum|MAXimum|DEFault}]
```

## System-Related Operations

This section covers instrument state storage, power-down recall, error conditions, self test, and display control. Though unrelated to waveform generation, these operations are important for instrument operation.

### Instrument State Storage

- There are two ways to store and retrieve instrument states:
  - Named state files, using front panel or **MMEMory:STORE:STATe** and **MMEMory:LOAD:STATe**
  - Memory locations 1 through 4, using **\*SAV** and **\*RCL**

#### NOTE

For 33600 Series instruments, the state files associated with \*SAV and \*RCL are saved in files called STATE\_0.STA through STATE\_4.STA. These files are located in the Settings directory of internal memory. You can manage these files using **MMEMory commands**.

- You can also use special storage location 0 with \*SAV and \*RCL, but location 0 is overwritten by the current instrument state on power down.
- Both state storage methods remember the selected function (including arbitrary waveforms), frequency, amplitude, DC offset, duty cycle, symmetry, and modulation parameters.
- If you delete an arbitrary waveform from non-volatile memory after storing the instrument state, the waveform data is lost and the instrument uses "exponential rise" in its place.
- Stored states are not affected by **\*RST**; a stored state remains until overwritten or specifically deleted.

## Operating Information

- Front Panel:

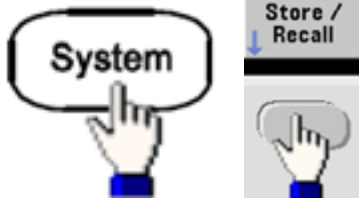

To save a state:



The state file will be created with .sta extension, using the name you specified with the knob and arrows.

To recall a state:

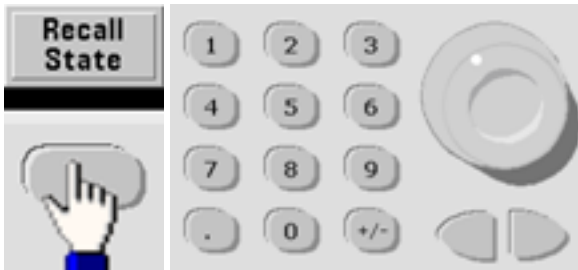

Use the right arrow to expand a folder. To select a file, press **Select**.

To delete a state:



Use the knob and arrows to select .sta file, and then press **Select**.

- You can configure instrument to power-down state from location 0 on power up. The factory default is to recall **factory default state** at power-on.

- Front Panel:



- SCPI: `MEMory:STATe:RECall:AUTO {ON|1|OFF|0}`

### Error Conditions

Up to 20 command syntax or hardware errors can be stored in each interface-specific error queue (one each for GPIB, USB, VXI-11, and Telnet/Sockets.) See [SCPI Error Messages](#) for more information.

- Front Panel:

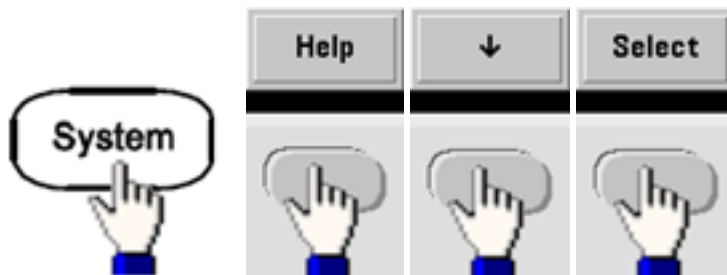

- SCPI: `SYSTem:ERRor?`

### Beeper Control

The instrument normally beeps when an error is generated from the front panel or remote interface.

- This setting is non-volatile; it will not be changed by power cycling or `*RST`.
- Front Panel:

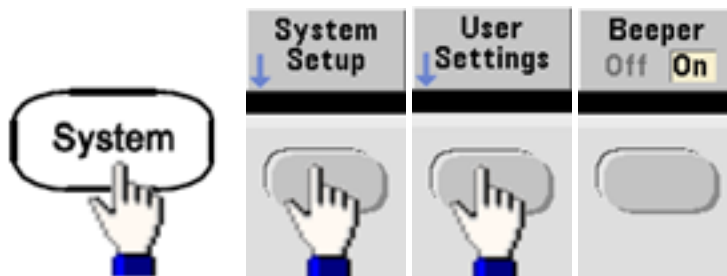

- SCPI:  
`SYSTem:BEEPer:STATe {ON|1|OFF|0}`

`SYSTem:BEEPer`

**NOTE**

On the 33600 Series, you can also enable and disable the click heard when a key is pressed. See `SYSTem:CLICK:STATe` for details.



### Display Screen Saver

The display's backlight normally turns off and reduces the screen brightness after eight hours of inactivity. You may disable this screen saver from the front panel only.

- This setting is non-volatile; it will not be changed by power cycling or \*RST.
- Front Panel:

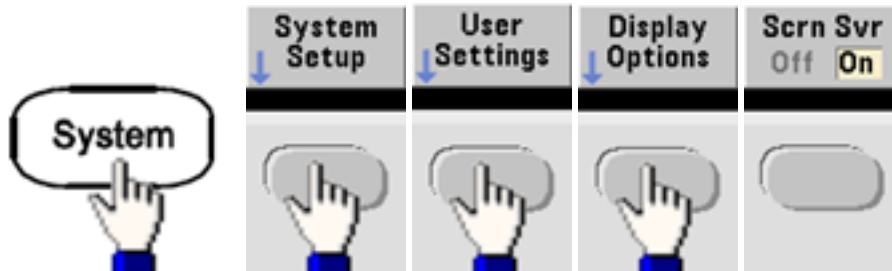

### Display Brightness

You can adjust display brightness (10% to 100%) from the front panel only.

- This setting is non-volatile; it will not be changed by power cycling or \*RST.
- Front Panel:

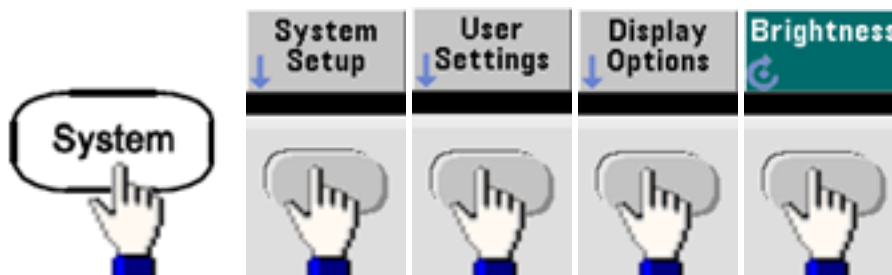

### Date and Time

You can set the instrument's date and time clock.

- Front Panel:

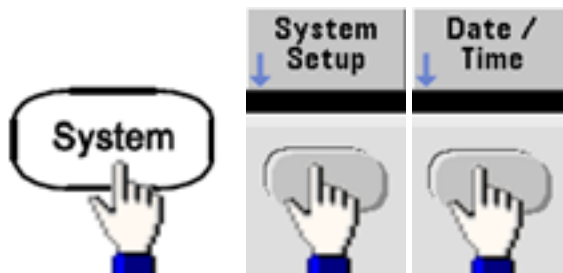

- SCPI:  
`SYSTEM:DATE <yyyy>, <mm>, <dd>`  
`SYSTEM:TIME <hh>, <mm>, <ss>`

## Manage Files

You can perform file management tasks, including copying, renaming, deleting, and creating new folders.

- **Front Panel:**

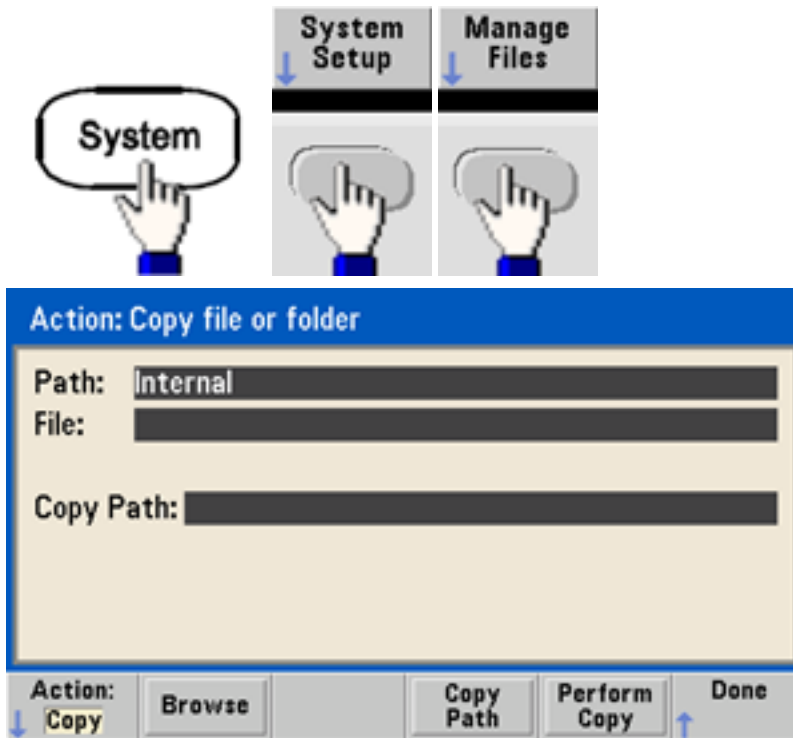

- You can copy, rename, or delete files or folders. Deleting a folder removes all of the files within the folder, so be sure that you want to delete all of the files within the folder.
- The most important softkey is **Action**, which allows you to specify the operation to perform. Once you have chosen the action to perform, press **Browse** to select the file to manage. Once you are completely prepared to execute the task, press **Perform**.
- **SCPI:** (see [MEMory](#) and [MMEMory](#) subsystems).

## Self-Test

- A limited power-on self-test occurs when you turn on the instrument to assure you that the instrument is operational. You can also run a more complete self-test. For details, see [Self-Test Procedures](#).

## Display Control

For security reasons, or to speed up the rate at which the instrument executes remote interface commands, you may want to **turn off the display**. You can also remotely **display a message** or **clear a message** on the display.

- The display is enabled when power is cycled, after an instrument reset (**\*RST**), or when you return to local (front panel) operation. Press the [**Local**] key or execute the IEEE-488 GTL (Go To Local) command from the remote interface to return to the local state.
- The display state is saved when you store the instrument state with **\*SAV** recalled by **\*RCL**.
- **Front Panel:**

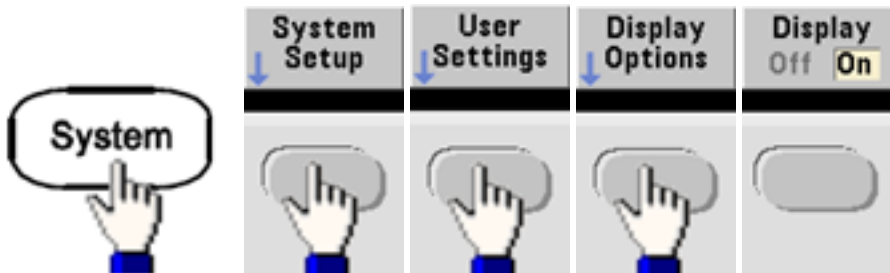

- **SCPI:**  
**DISPlay {ON|1|OFF|0}**  
  
**DISPlay:TEXT "<string>"**  
  
**DISPlay:TEXT:CLEAr**

## Number Format

The instrument can display numbers on the front panel with periods or commas for the decimal point and digits separator. The default is a period decimal point with commas for digit separation (1.000,000,00 kHz).

- This setting is non-volatile; it will not be changed by power cycling or **\*RST**.
- **Front Panel:**

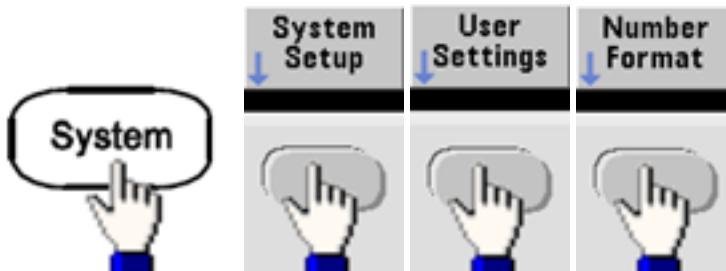

- **SCPI:** (No equivalent command)

## Firmware Revision Query

Send **\*IDN?** to determine which revision of firmware is currently installed. The query returns a string of the form:

**Keysight Technologies,[Model Number],[10-char Serial Number],A.aa-B.bb-C.cc-DD-EE**

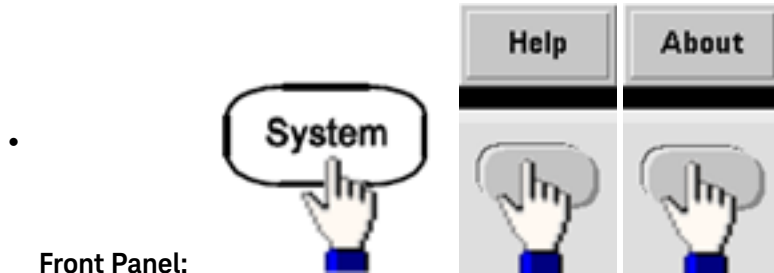

Front Panel:

- **SCPI: \*IDN?**

## SCPI Language Version Query

The instrument complies with the rules and conventions of the present version of SCPI (Standard Commands for Programmable Instruments). Use **SYSTem:VERsion?** to determine the SCPI version with which the instrument complies. The query returns a string in the form "YYYY.V", representing the year and version number for that year (for example, 1999.0).

## License Installation

The Trueform Series has **several optional features** that require licenses for installation. To install a license:

1. Install the license file onto a USB drive and insert the USB drive into the instrument's front panel.
2. Press **[System] > System Setup > Install License**.
3. Use the knob and arrows to select the file under **External**, then press **Enter**.

There are also several **SCPI commands associated with license installation**.

## Remote Interface Configuration

The instrument supports remote interface communication over three interfaces: GPIB (optional), USB, and LAN. All three are "live" at power up.

- **GPIB Interface:** Set the instrument's GPIB address connect to your PC using a GPIB cable.
- **USB Interface:** No configuration; simply connect instrument to PC with a USB cable.
- **LAN Interface:** By default, DHCP is on, which may enable communication over LAN. The acronym DHCP stands for Dynamic Host Configuration Protocol, a protocol for assigning dynamic IP addresses to networked devices. With dynamic addressing, a device can have a different IP address every time it connects to the network.

## Keysight IO Libraries Suite

**NOTE**

Ensure that the Keysight IO Libraries Suite is installed before you proceed for the remote interface configuration.

Keysight IO Libraries Suite is a collection free instrument control software that automatically discovers instruments and allows you to control instruments over the LAN, USB, GPIB, RS-232, and other interfaces. For more information, or to download IO Libraries, go to [www.keysight.com/find/iosuite](http://www.keysight.com/find/iosuite).

### GPIB Configuration

Each device on the GPIB (IEEE-488) interface must have a unique whole number address between 0 and 30. The instrument ships with a default address of 10, and the GPIB address is displayed at power-on.

- This setting is non-volatile; it will not be changed by power cycling or \*RST.
- Your computer's GPIB interface card address must not conflict with any instrument on the interface bus.
- **Front Panel:**  
Press [System] > I/O Config > GPIB Settings to set the GPIB address and turn GPIB on or off.

- **SCPI:**  
`SYSTem:COMMunicate:GPIB:ADDRes <address>`

`SYSTem:COMMunicate:ENABle <state>,GPIB`

`SYSTem:COMMunicate:ENABle? GPIB`

### LAN Configuration

The following sections describe the primary front panel LAN configuration functions, including SCPI commands where applicable. Some LAN configuration functions that can be performed only via SCPI. See [LAN Configuration Introduction](#) for all LAN configuration commands, and see [LAN Configuration Procedure](#) for a procedure to configure the LAN via the front panel.

**NOTE**

Some LAN settings require you to cycle power on the instrument in order for them to be activated. The instrument briefly displays a message when this is the case, so be sure to watch the screen closely as you change LAN settings.

**Resetting the LAN**

You can clear the Web Interface password, turn DHCP on, and restart the LAN at any time:

- **Front panel:**



The message "Performing LAN Reset" is displayed while the LAN is reset.

- **SCPI:** (No equivalent command)

**DHCP On/Off**

DHCP (Dynamic Host Configuration Protocol) can automatically assign a dynamic IP address to a LAN device. Typically easiest way to configure instrument for LAN.

- This setting is non-volatile; it will not be changed by power cycling or \*RST.

- **Front Panel:**

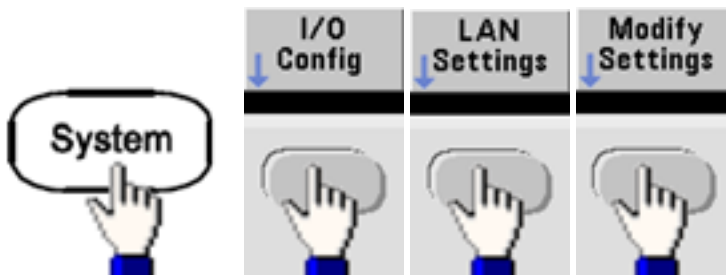

Finally, toggle the first softkey to DHCP to use DHCP to automatically assign an IP address.

- **SCPI:** `SYSTem:COMMunicate:LAN:DHCP {ON|1|OFF|0}`

To manually set an IP address, Subnet Mask, or Default Gateway, turn DHCP off, then change IP setup as described below.

### IP Address

You can enter a static IP address for the instrument as a four-byte integer expressed in dot notation. Each byte is a decimal value, with no leading zeros (for example, 169.254.2.20).

- If DHCP is on, it attempts to assign an IP address to the instrument. If it fails, AutoIP attempts to assign an IP address to the instrument.
- Contact your LAN administrator to obtain an IP address.
- This setting is non-volatile; it will not be changed by power cycling or \*RST.
- **Front Panel:**

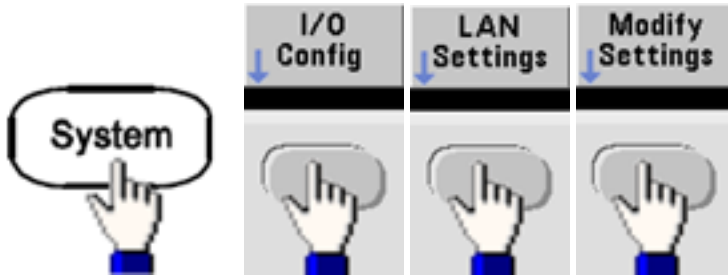

- Finally, toggle the first softkey to **Manual** and press **IP Address** to enter a new IP address. Enter the desired address.
- **SCPI:** `SYSTem:COMMunicate:LAN:IPADdress "<address>"`

### Subnet Mask

Subnetting allows the LAN administrator to subdivide a network to simplify administration and minimize network traffic. The subnet mask indicates the portion of the host address used to indicate the subnet.

- Contact your LAN administrator for details.
- This setting is non-volatile; it will not be changed by power cycling or \*RST.
- **Front Panel:**

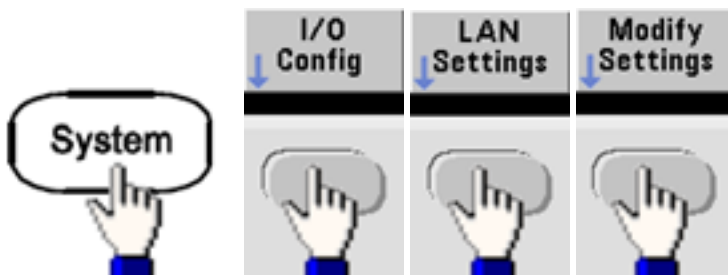

- Finally, toggle the first softkey to **Manual** and press **Subnet Mask** to enter a new subnet mask with the numeric keypad or knob (for example: 255.255.0.0).
- **SCPI:** `SYSTem:COMMunicate:LAN:SMASk "<mask>"`

### Default Gateway

A gateway is a network device that connects networks. The default gateway setting is the IP address of such a device.

- You need not set a gateway address if using DHCP or AutoIP.
- Contact your LAN administrator for gateway details.
- This setting is non-volatile; it will not be changed by power cycling or \*RST.
- **Front Panel:**

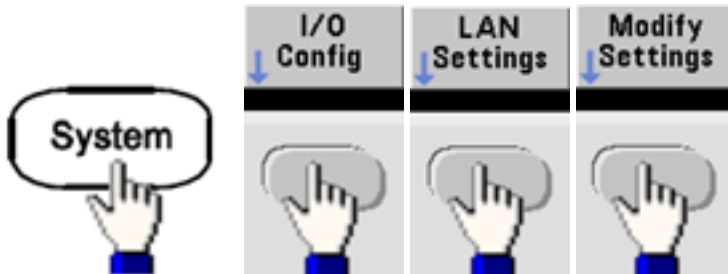

Finally, toggle the first softkey to **Manual** and press **More** and **Gateway**. Then set the appropriate gateway address using the numeric keypad or knob.

- **SCPI:** `SYSTem:COMMunicate:LAN:GATeway "<address>"`

### Hostname

A hostname is the host portion of the domain name, which is translated into an IP address.

- The instrument receives a unique hostname at the factory, but you may change it. The hostname must be unique on the LAN.
- The name must start with letter; other characters can be upper or lower case letters, numeric digits, or dashes ("-").
- This setting is non-volatile; it will not be changed by power cycling or \*RST.
- **Front Panel:**

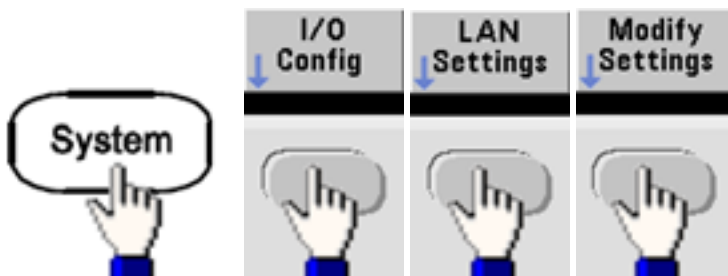

Finally, press **Host Name** and enter the hostname with the knob and arrows. The knob changes the character; cursor arrows move between characters.

- **SCPI:** `SYSTem:COMMunicate:LAN:HOSTname "<name>"`



## Operating Information

### Domain Name

A domain name is a registered Internet name that gets translated into an IP address. You cannot set it from the front panel or SCPI.

### DNS Server

DNS (Domain Name Service) is an Internet service that translates domain names into IP addresses. The DNS server address is the IP address of a server that performs this service.

- Normally, DHCP discovers DNS address information; you only need to change this if DHCP is unused or not functional. Contact your LAN administrator for DNS server details.
- This setting is non-volatile; it will not be changed by power cycling or \*RST.
- **Front Panel:**

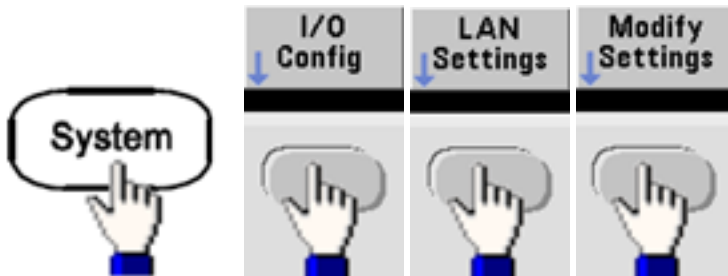

Finally, toggle the first softkey to **Manual** and press **More** and **Primary DNS** or **Second DNS** to enter a DNS address using the numeric keypad or knob.

- **SCPI:** `SYSTem:COMMunicate:LAN:DNS[1|2] "<address>"`

### Current Configuration (LAN)

- Select the Currently Active Settings display to view the MAC address and current LAN configuration.

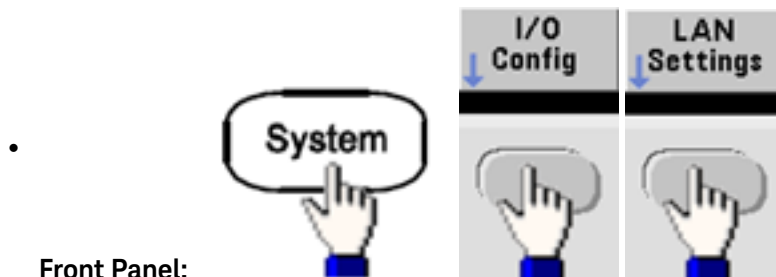

- **SCPI:** (No equivalent command)

The display reflects only currently active settings when first displayed; it does not update with changes occurring after the information is displayed. For example, if DHCP assigns an IP address with display open, a new IP address will not appear.

If the instrument goes into remote, all LAN changes will be canceled, and the display will go to a different screen. Re-selecting the LAN Settings page will display the new settings if a LAN restart took place.

See [SYSTem Subsystem Introduction](#) for additional LAN configuration commands.

## Web Interface

The instrument includes a built-in Web Interface. You can use this interface over LAN for remote instrument access and control via a Java™-enabled Web browser, such as Microsoft Internet Explorer.

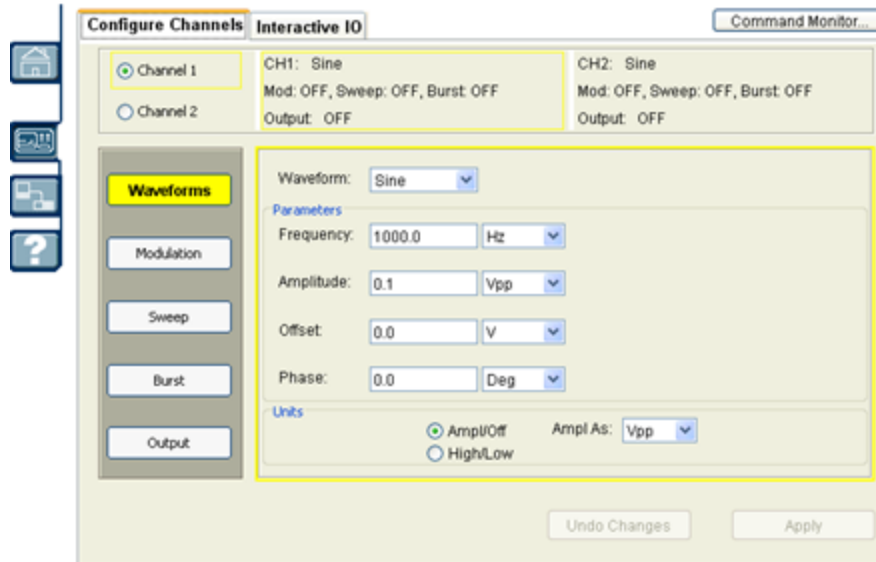

To use the Web Interface:

1. Establish a LAN connection from your PC to the instrument.
2. Open your PC's Web browser.
3. Launch the instrument's Web Interface by entering the instrument's IP address or fully-qualified hostname in the browser address field.
4. Follow the instructions in the Web Interface's on-line help.

## USB Configuration

Front Panel:

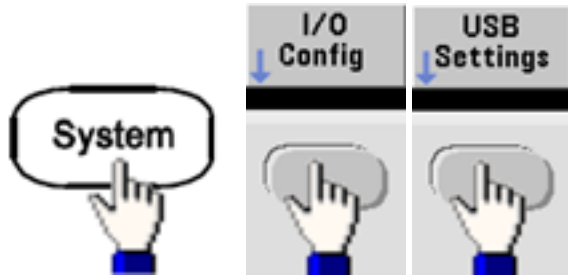

On the 33500 Series, there are no user-configurable USB parameters. You can only retrieve the USB ID string (set by the manufacturer) by using the **Show USB Id** softkey.

**Easy File Access (33600 Series only)**

**Easy File Access** uses media transfer protocol (MTP) to easily download instrument files to your PC. Simply connect the rear-panel USB port on the instrument to a USB port on your PC. The DMM will appear as a read-only drive on your PC's file system. Note that the instrument's internal storage includes a pre-defined directory structure, as shown below.

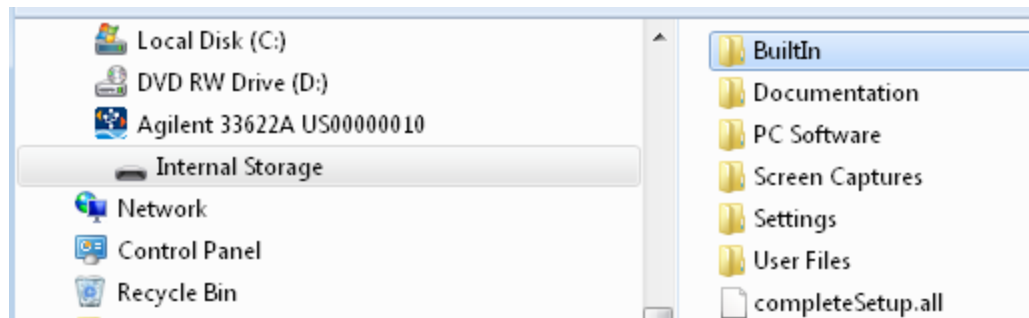

You can use your PC's standard file management features to copy files from the DMM to your PC.

**NOTE**

To use **Easy File Access** at the same time that you are remotely programming the instrument with SCPI over the USB interface (**USB SCPI**), you must have Keysight IO Libraries Suite 16.3 or later installed on your PC. You may download the latest version at [www.keysight.com/find/iosuite](http://www.keysight.com/find/iosuite).

To use Easy File Access on a PC running the Windows XP operating system, make sure you have Microsoft Windows Media Player 11 for Windows XP or later installed before you hook up the USB cable. You may download this software at [www.microsoft.com/en-us/download/details.aspx?id=8163](http://www.microsoft.com/en-us/download/details.aspx?id=8163).

## External Timebase Reference

**WARNING**

The external 10 MHz reference input BNC connector, both the shell and center pin, on the rear panel of the instrument is isolated up to  $\pm 42$  Vpk from chassis. The shell of this BNC connector is isolated from the rest of the instrument. Internal circuitry will attempt to keep the isolated voltage to within  $\pm 42$  Vpk to chassis. Attempts to float this input beyond  $\pm 42$  Vpk from chassis may destroy the instrument and cause a hazard that could result in personal injury or death.

The external timebase reference provides rear panel connectors (**10 MHz In** and **10 MHz Out**) and circuitry to allow synchronization between multiple instruments or to an external 10 MHz clock signal. You can also set the phase offset of the output waveform from the front panel or over the remote interface.

To align the phase of two instruments, use a dual-channel oscilloscope to compare the output signals:

1. Connect the two instruments, with **10 MHz Out** connected to **10 MHz In**. Use the instrument with the more precise timebase as the 10 MHz reference output source.

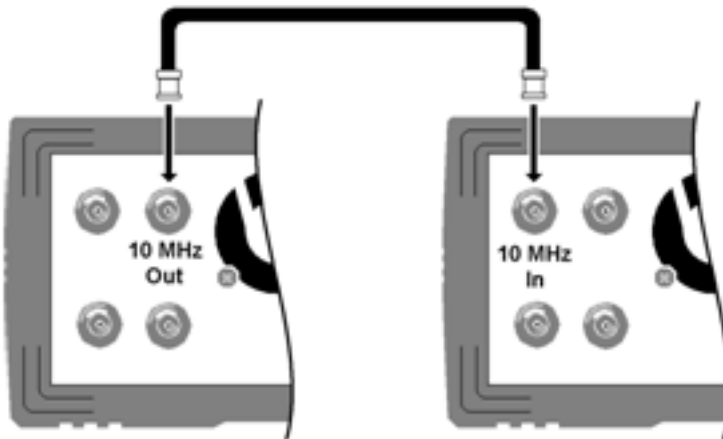

2. Connect instrument outputs to scope channel inputs:

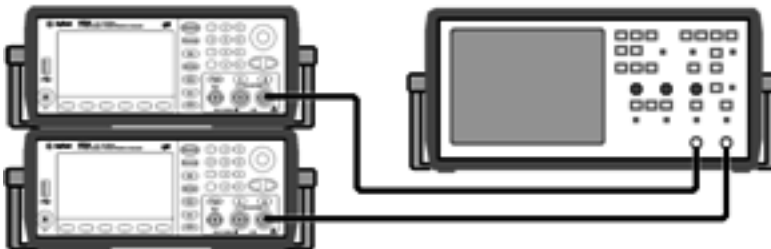

3. Set the same frequency on both instruments. The scope should show the signals to be in sync with regard frequency, but not phase. (A square wave works well to show the phase difference.)
4. For two-channel instruments, phase sync the two channels to each other. This also synchronizes each channel's modulating waveforms to the carrier.

Front panel:

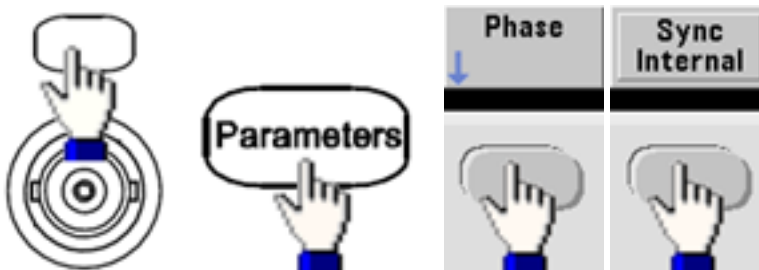

SCPI: `[SOURCE[1|2]:]PHASE:SYNChronize`

## Operating Information

- Leaving the phase setting at its default (zero) on the first instrument, use **Adjust Phase** to adjust the phase of the second instrument to align the output signals:

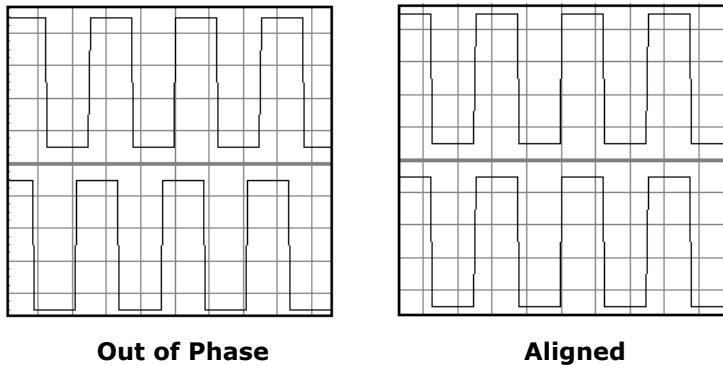

You can use **Set 0 Phase** to set a new zero-phase reference point with the two instruments now aligned.

- **Front Panel:**

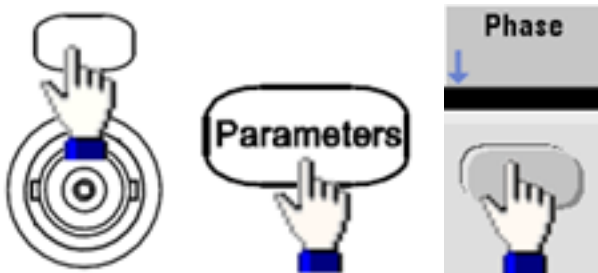

Then set the phase angle using the keypad or knob. Once they are aligned, press **Set 0 Phase**.

- **SCPI:**

`[SOURCE[1|2]:]PHASe {<angle>|MINimum|MAXimum|DEFault}`

`[SOURCE[1|2]:]PHASe:REFerence`

## Embedded Waveform Editor

The instrument includes an embedded waveform editor for creating and editing single-channel arbitrary waveforms in ASCII arbitrary waveforms (.ARB suffix). You can enter and edit voltage values directly or by combining up to 12 different kinds of standard waveforms, as described in the following sections:

[Standard Waveforms](#)

[Basic Waveform Editing](#)

[Advanced Edit](#)

[Advanced Math](#)







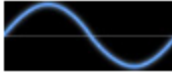

[Utility Menu](#)

### NOTE

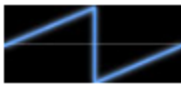
Regardless of what options may be installed, the maximum waveform size for the embedded waveform editor is 1 MSA.

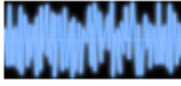
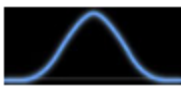
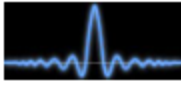
## Standard Waveforms

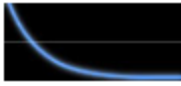
The embedded waveform editor includes the following 12 waveforms:

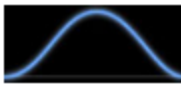
Sine		$y = \sin(x)$
Square		A square wave that switches between two voltage levels
Ramp		A waveform with linearly rising or falling voltage
Line		Line segment
DC		A DC voltage
Noise		Random noise
Gaussian		A gaussian bell curve (normal distribution)
Sinc		$y = \sin(x)/x$
D-Lorentz		The derivative of the Lorentz function. The Lorentz function is $y = 1/(x^2+1)$ , so the D-Lorentz function is $y = -2x/(x^2+1)^2$ .
Expo Fall		Exponential decay: $y = e^{-kx}$
Expo Rise		Exponential rise: $y = 1 - e^{-kx}$
Haversine		$y = [1 - \cos(x)]/2$

## Operating Information

When you select a waveform, the instrument displays a screen for specifying the waveform's parameters, listed below.

Amplitude	The peak height above 0 V when the waveform has 0 offset, from 10 $\mu$ V to 10 V (default 1).
Offset	The distance the waveform is shifted up or down relative to 0 V, from -10 to 10 V (default 0).
The Amplitude plus the Offset must be between -10 V and 10 V.	
Phase	The number of degrees that the waveform is advanced (positive value) or retarded (negative value) from 0 degrees, from -360 to 360 (default 0).
Cycles	The number of complete output cycles (a positive integer) that the waveform includes.
Points	The number of points the waveform includes up to 1,000,000 (default 100). The minimum number of points on the 33500 Series is 8, and the minimum number of points on the 33600 Series is 32.
Half Width (D-Lorentz only)	A value that controls the waveform width; larger values make wider curves. An integer from 1 to the total number of points in one cycle (default 10).
Fall Factor (Expo Fall only)	A decimal number from -99 to 99 that controls how fast the waveform falls or rises (default -5).
Rise Factor (Expo Rise only)	
Full Width (Gaussian only)	The width of the bell curve between the points on the curve that are one-half the curve's height, from 1 to the number of points in one cycle (default 10).
Symmetry (Ramp only)	The percentage of time (per cycle period) that the ramp rises, a decimal from 0 to 100 (default 100).
Zero Crossing (Sinc only)	The number of times the waveform crosses the horizontal axis on one side of the waveform, from 0 to 100 (default 10).
Duty Cycle (Square only)	The percentage of the time (per cycle period) that the waveform voltage is high, from 0 to 100 (default 50).
Start Level (Line only)	The voltage at the beginning or end of the line segment.
End Level (Line only)	

### Basic Waveform Editing

When you start the embedded waveform editor ([Waveforms] > Arb > Arbs > Edit Arb File > New Arb File), the opening screen appears. (Note that the same menu that contains the **Edit Arb File** softkey also contains an **Import Data** softkey. You can use this to import ASCII files from oscilloscopes and other common instruments.)



**Edit Points** allows you to edit the voltage values of individual points in the waveform. You can also insert and remove points in the waveform, and you can access the **Advanced Edit** features, described below. The current screen image shows the default new arbitrary waveform of 8 points at 0 VDC.

**NOTE** The default arbitrary waveform size is 8 points the 33500 Series and 32 points on the 33600 Series.

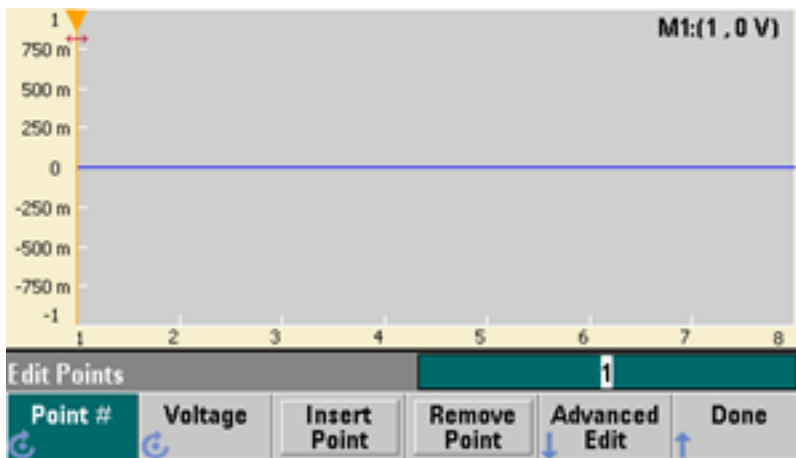



## Operating Information

**Edit Params** allows you to set the waveform's sample rate, which is the rate (in points per second) in which the waveform is played. You can specify this value as a rate or as a period. If you change one, the other will recalculate based on the number of points in the waveform. This feature also allows you to specify whether the waveform is labeled with units of time or points along the horizontal axis.

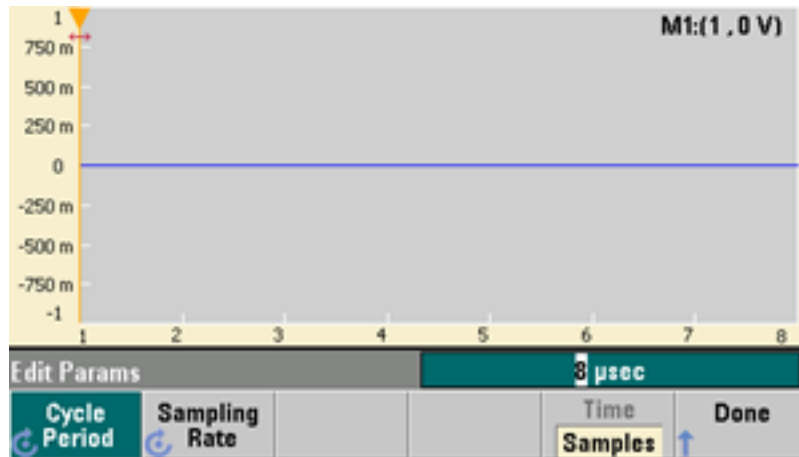

**Insert Built-In** allows you to insert one of 12 pre-defined waveforms into the current waveform.

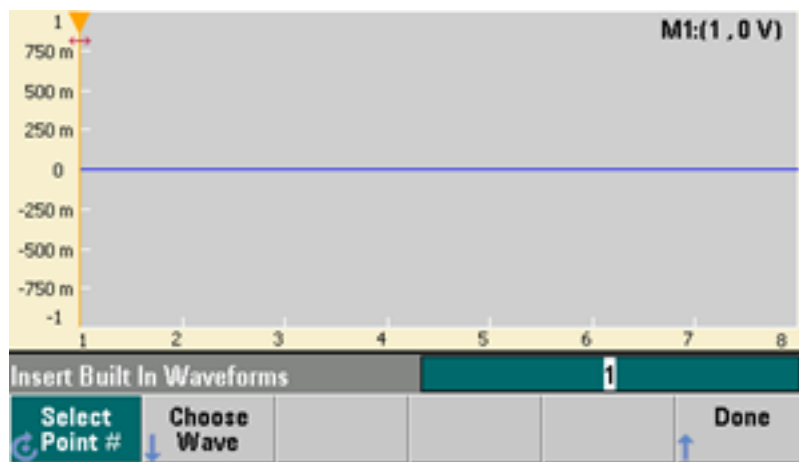

**Select Point #** allows you to specify where the waveform is to be inserted, and the **Choose Wave** softkey allows you to specify which one of the 12 waveform types is to be inserted.

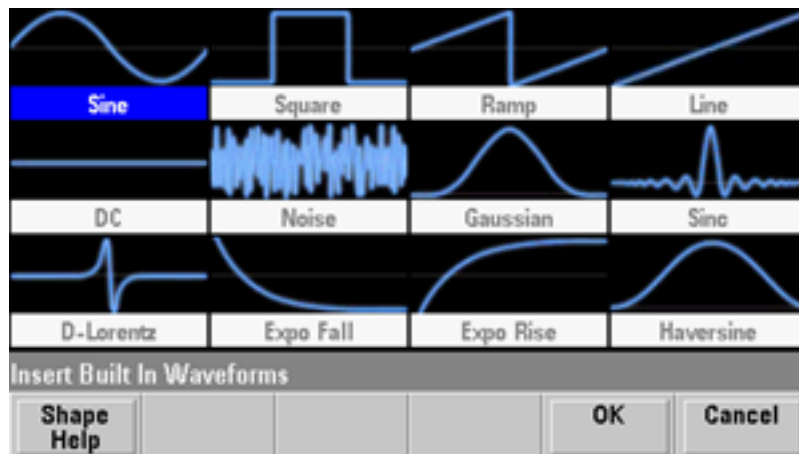

Once you have used the arrow keys to select the waveform to insert and pressed **OK**, the instrument displays the parameters for the waveform to be inserted. Note the up and down arrow softkeys, which you use to select a parameter for editing. Specify the parameters and press **OK**.

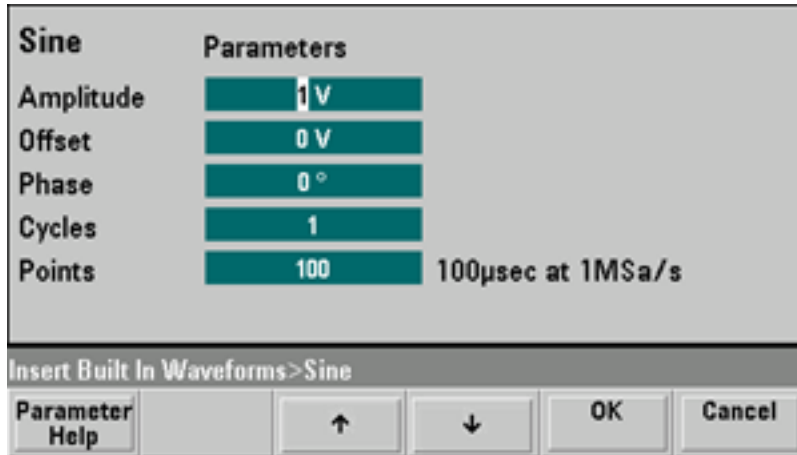

**Save** allows you to save the current waveform at its current location in the instrument's internal memory.

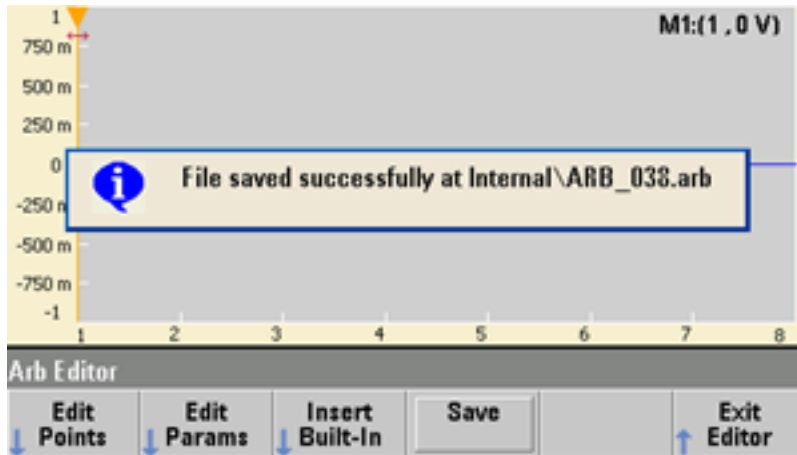

**Exit Editor** closes the waveform editor and resumes normal operation.



If you have unsaved changes, a message gives you the option of staying in the embedded waveform editor. After you exit the editor, you will have the option to play the waveform on the waveform generator.



### Advanced Edit

As described above, the **Edit Points** menu includes an **Advanced Edit** softkey. This softkey allows you to cut, copy and paste portions of the waveform, edit waveform points in a table, and perform mathematical operations on the waveform.

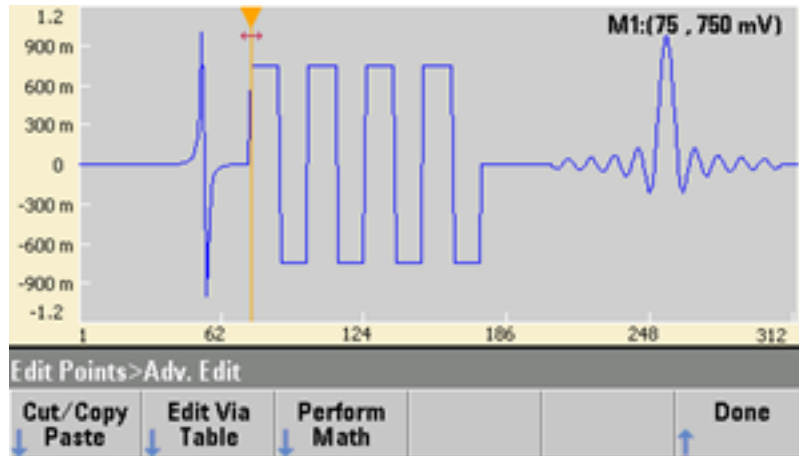

**Cut/Copy/Paste** allows you to define a range of the waveform between two markers and then cut or copy the waveform points defined by the markers. Once you have cut or copied the range, you can paste it as many times as desired by using the **Paste** softkey.

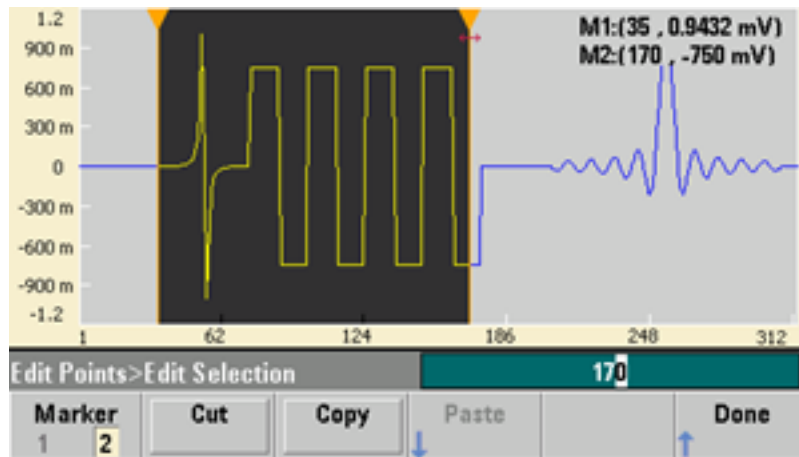

**Paste Location** allows you to paste a range at the start of the waveform, the end of the waveform, or any point within the waveform.



## Operating Information

**Edit Via Table** allows you to edit the voltage values of individual points in a table. You can use the knob to scroll through the table, or you can use the **Point #** softkey to directly select any particular point. You can also insert or remove waveform points.

Point No. (Max 312)	Voltage Value (Volts)
1	0.00000
2	0.00000
3	0.00000
4	0.00000
5	0.00006
6	0.00006
7	0.00007
8	0.00007

Edit Points>Table 1

Point # Voltage Insert Point Remove Point Done

**Perform Math** allows you to use markers to specify a range of the waveform. You can then add, subtract, or multiply the voltage values in that range by the voltage values in another waveform.

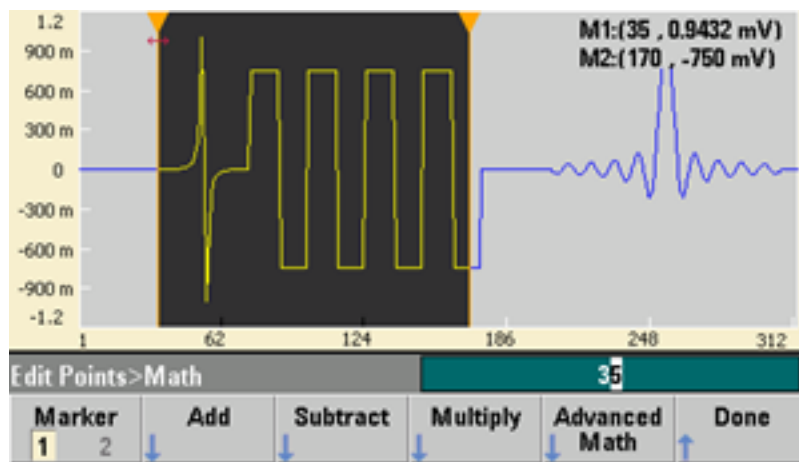

Once you have pressed **Add**, **Subtract**, or **Multiply**, the instrument displays a list of waveforms. Pick the waveform and press **OK**.

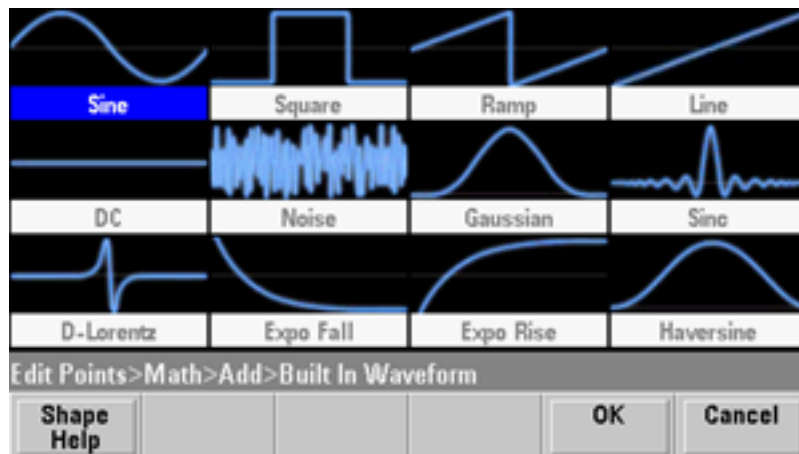

When you press **OK**, the instrument displays a list of parameters that you can use to specify the waveform. In this case, the screen below shows that you picked **D-Lorentz**. You can also use the **From Point** and **To Point** parameters to specify the range of points on which to perform the mathematical operation.

<b>D-Lorentz</b>		Parameters	Modify existing waveform
Amplitude	1 V	From Point	35
Offset	0 V	To Point	170
Phase	0 °		
Cycles	1		
Half Width	10		

Edit Points>Add>Built In Waveform>D-Lorentz

Parameter Help	↑	↓	OK	Cancel
----------------	---	---	----	--------

### Advanced Math

**Advanced Math** allows you to perform several mathematical operations on the waveform. To begin, press **Edit Points > Advanced Edit > Perform Math > Advanced Math**.

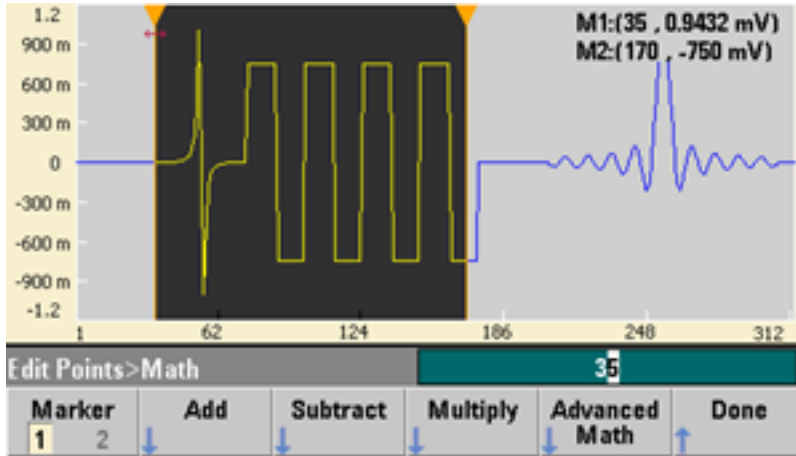

The **Advanced Math** menu opens with the following screen. Each of the operations shown below will be described below, using images taken before and after each operation to demonstrate the operations' effects.

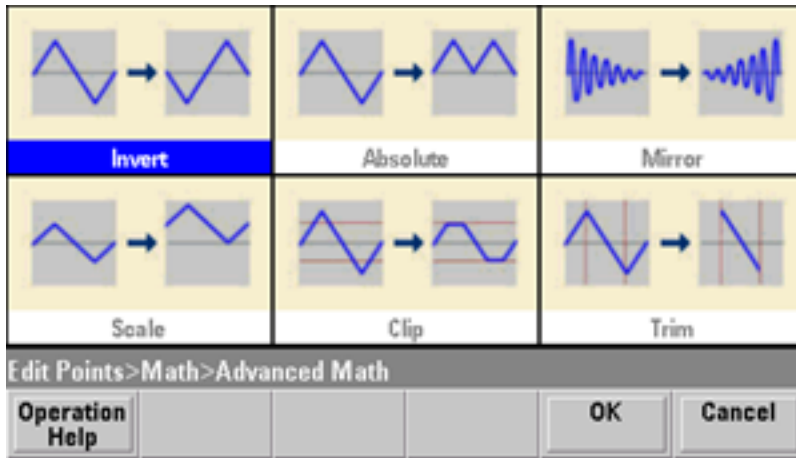

**Invert** reflects the waveform across the horizontal axis.

Image Before Invert

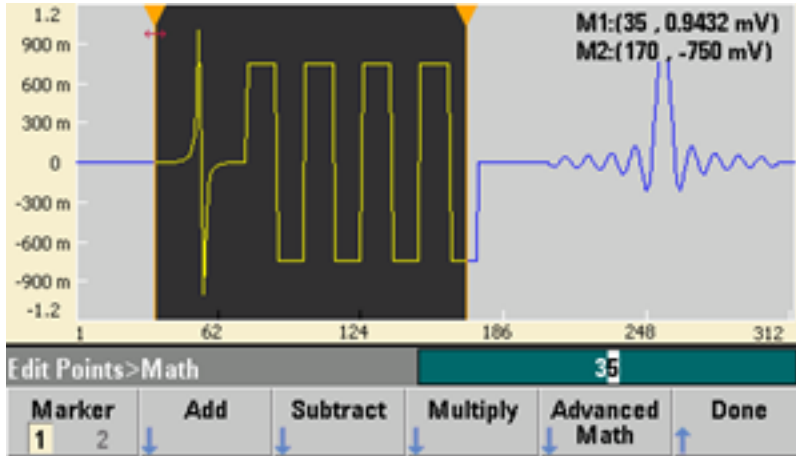
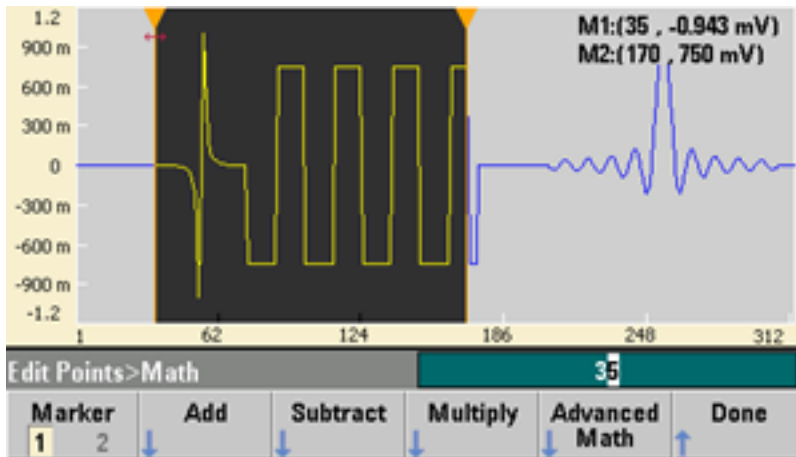

Image After Invert





## Operating Information

**Absolute** multiplies all negative waveform values by -1.

Image Before Absolute

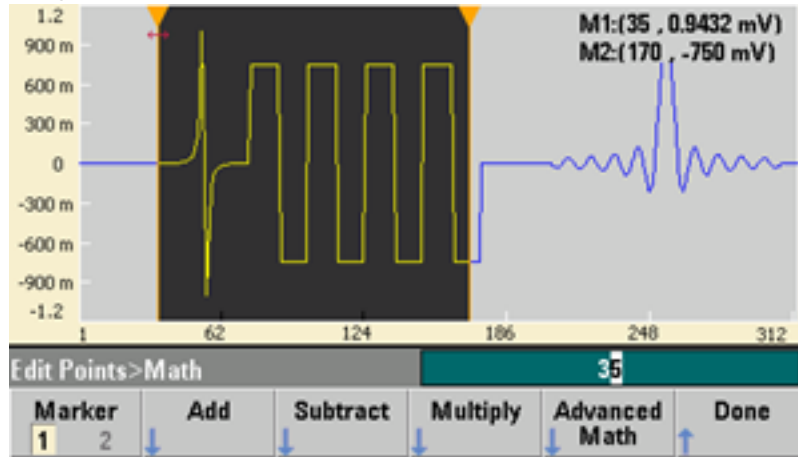

Image After Absolute



**Mirror** reverses order of the points in the range.

Image Before Mirror

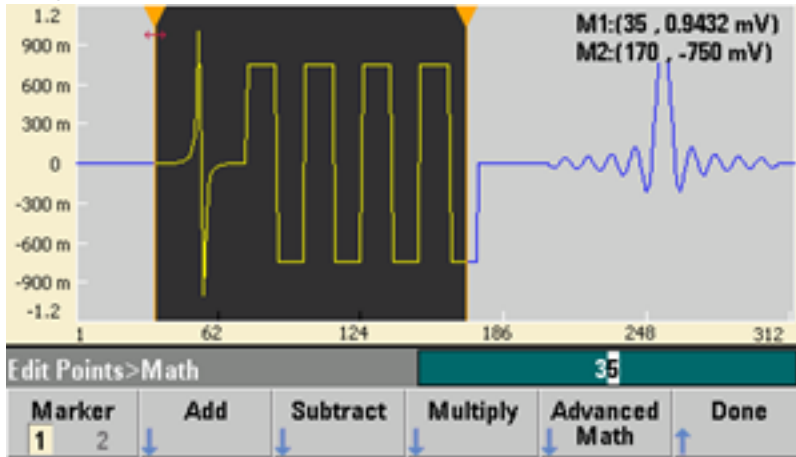
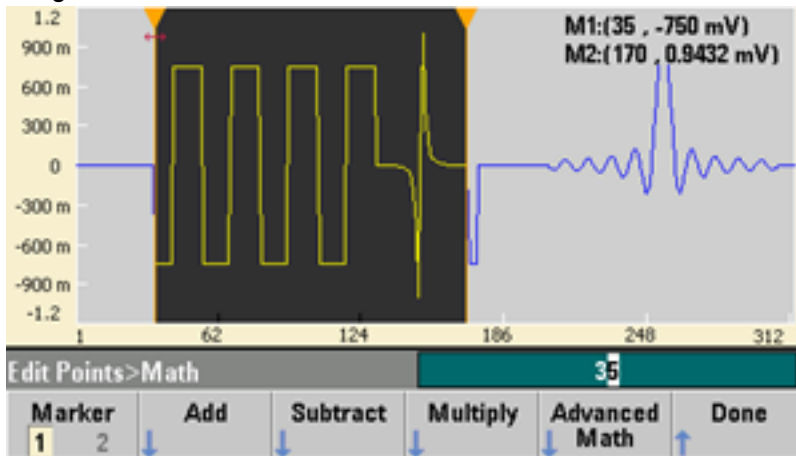

Image After Mirror



## Operating Information

**Scale** allows you to scale the waveform's amplitude and offset. Here, the amplitude scale was set to 180% and the offset scale was set to 1 V.

Image Before Scale

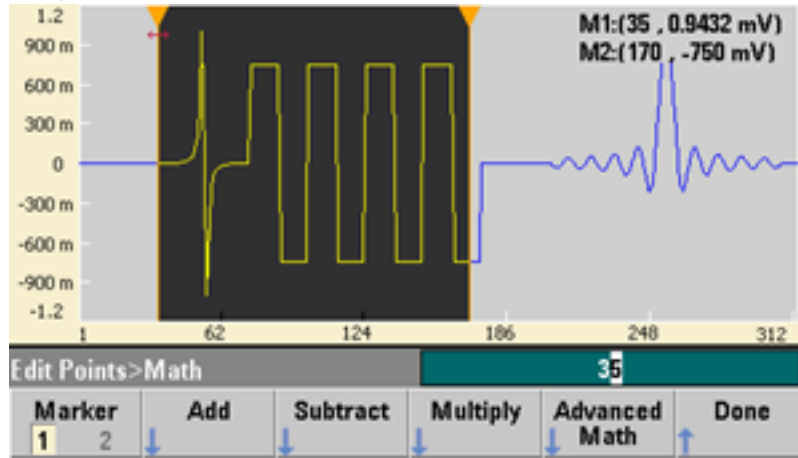
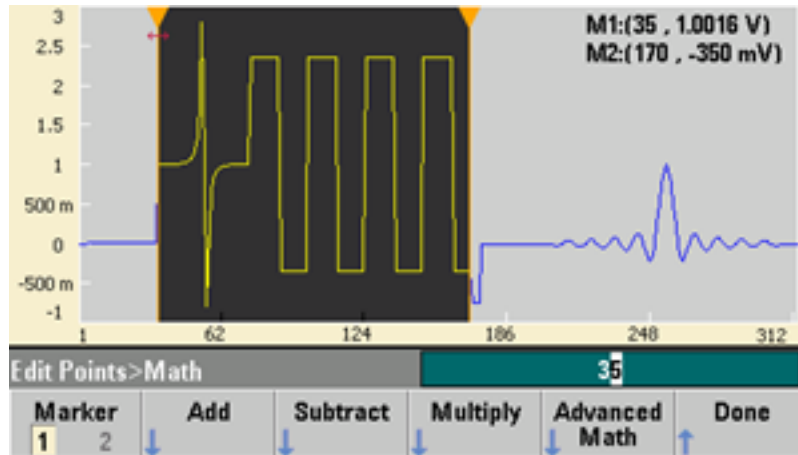

Image After Scale



**Clip** allows you to change voltage values outside upper and lower limits to be equal to the limits. In this example, the waveform was clipped to stay within the -400 mV lower limit and the 700 mV upper limit.

Image Before Clip

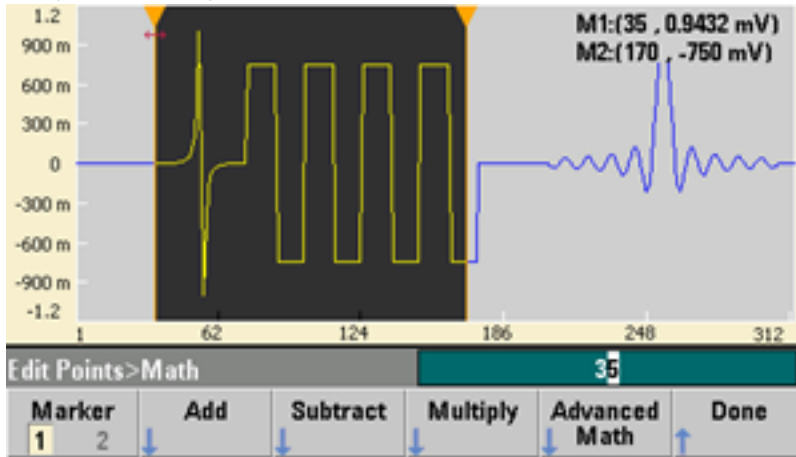
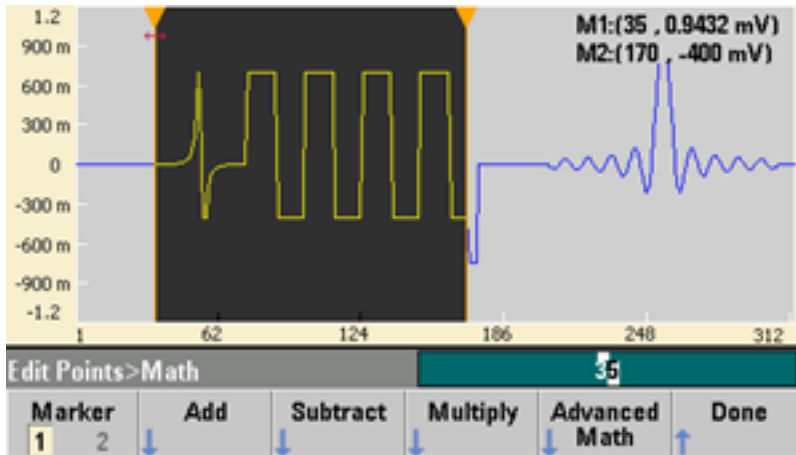

Image After Clip



## Operating Information

**Trim** allows you to use markers to "crop" the waveform so that only the points defined by the marker range remain in the waveform.

Image Before Trim

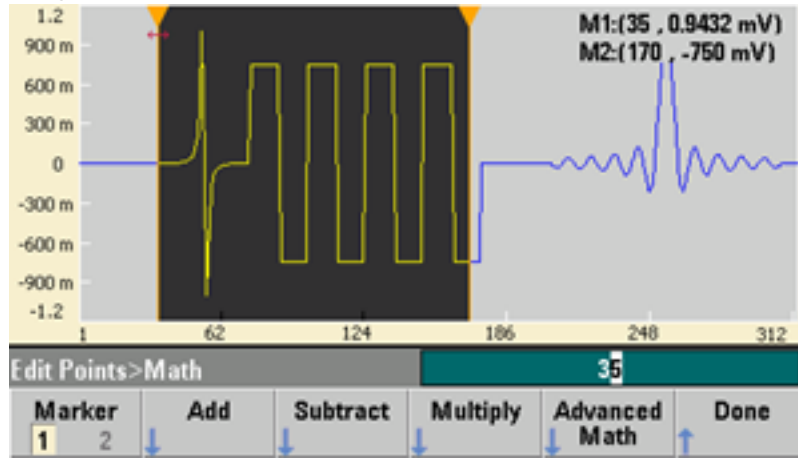
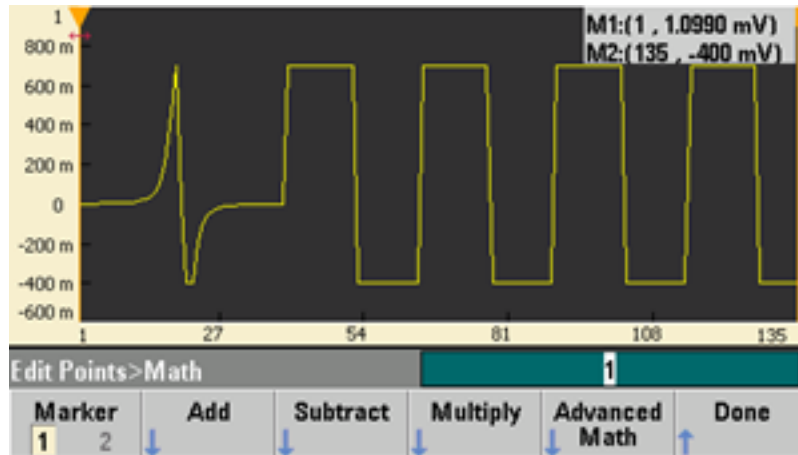
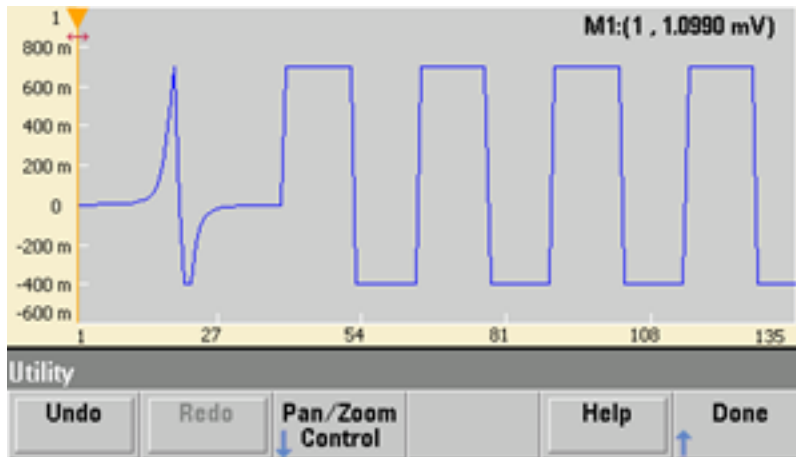

Image After Trim



## Utility Menu

You can access several utility features by pressing the **[System]** key from within the embedded waveform editor.



**Undo** allows you to undo recent operations, subject to the amount of available memory and the size of the undo operation. **Redo** allows you to redo "undone" tasks, subject to the same limitations.

**Pan/Zoom Control** allows you to pan or zoom horizontally or vertically. You zoom using a percentage zoom factor, and you pan by specifying a point, and or voltage.

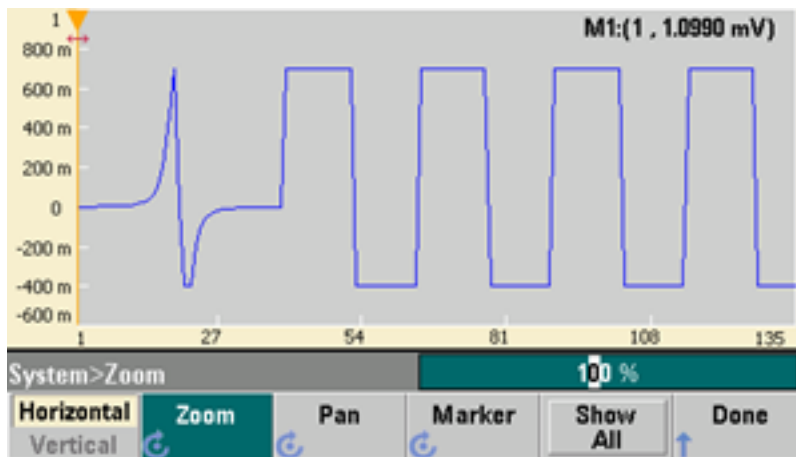

**Show All** resets the scaling to display the entire waveform.

## Waveform Generation Tutorial

This section describes theory of operation information for several waveform types and instrument operating modes. The last two topics include information that may help you improve signal quality.

- [Arbitrary Waveforms](#)
- [Quasi-Gaussian Noise](#)
- [PRBS](#)
- [Modulation](#)

## Operating Information

- [Burst](#)
- [Frequency Sweep](#)
- [Attributes of AC Signals](#)
- [Signal Imperfections](#)
- [Ground Loops](#)

## Arbitrary Waveforms

Arbitrary waveforms can meet needs not met by the instrument's standard waveforms. For example, you might need a unique stimulus, or you might want to simulate signal imperfections such as overshoot, ringing, glitching, or noise. Arbitrary waveforms can be very complex, making them suitable for simulating signals in modern communications systems.

You can create arbitrary waveforms from a minimum of 8 points (33500 Series) or 32 points (33600 Series) up to 1,000,000 points. The instrument stores these numeric data points, known as "samples," in memory and then converts them into voltages as the waveform is generated. The frequency at which points are read is the "sample rate," and the waveform frequency equals the sample rate divided by the number of points in the waveform. For example, suppose a waveform has 40 points and the sample rate is 10 MHz. The frequency would be  $(10 \text{ MHz})/40 = 250 \text{ kHz}$  and its period would be 4  $\mu\text{s}$ .

### Dual Arbitrary Waveforms

Arbitrary waveforms may be single-channel waveforms, or ([with option IQP](#)), they may be dual-channel arbitrary waveforms, such as IQ baseband signals. A dual arbitrary waveform is analogous to a stereo music file. It has two channels of information that contain the same number of samples, always start and end together, and always play at the same sample rate.

You can control the skew and balance between channels on dual arbitrary waveforms either via [commands in the SCPI FUNCTION subsystem](#) or via the [front panel](#).

### Waveform Filters

The instrument includes two filters to smooth transitions between points as arbitrary waveforms are generated.

- Normal filter: a wide, flat frequency response, but its step response exhibits overshoot and ringing
- Step filter: a nearly ideal step response, but with more roll-off in its frequency response than the Normal filter
- Off: output changes abruptly between points, with a transition time of approximately 10 ns.

Each filter's cutoff frequency is a fixed fraction of the waveform's sample rate. The Normal filter's response is -3 dB at 27% of the sample rate and the Step filter's response is -3 dB at 13% of the sample rate. For example, for an arbitrary waveform at 100 MSa/s, the Normal filter's -3 dB frequency bandwidth is 27 MHz.

Turning the filter off may change the sample rate to a lower rate if the sample rate was greater than 250 MSa/s before the filter was turned off.

## Waveform Sequencing Applications

Arbitrary waveform sequences are useful when the waveform you want to generate in two situations:

- The waveform is very long and contains repetitions of shorter fragments. These fragments can be repeated any number of times in any order.
- You need real-time control (triggers) to change from one waveform fragment to another.

For an example of the first case, consider a signal that must play the same introductory waveform several times, then play three other waveforms once each, and then return to play the first waveform continuously. This might be a simulated modem data packet consisting of an "idle" signal, a header, some data, a checksum, and a return to the "idle" signal.

This might consist of the following sequence description:

1. Play "idle.arb" 10 times
2. Play "header.arb" once
3. Play "data.arb" once
4. Play "checksum.arb" once
5. Play "idle.arb," repeating indefinitely.

In the second case, you may want to initiate the sending of "header.arb" using an external hardware trigger. This case might use the following description:

1. Play "idle.arb" repeatedly until a trigger is received
2. Play "header.arb" once
3. Play "data.arb" once
4. Play "checksum.arb" once
5. Play "idle.arb," repeating indefinitely.

A sequence file (\*.seq) contains the information in the numbered lists, and the arbitrary waveform files (\*.arb) contain the individual waveforms themselves.



## Waveform Sequencing Implementation

The instrument can assemble long, complex sequences of arbitrary waveforms (segments). Switching between segments occurs seamlessly in real time. As an analogy, think of segments as songs in a music player and sequences as play lists.

Each sequence step specifies a segment and how many times it is played. It also specifies whether the sequence waits for a trigger before the next step and how the **Sync** signal is generated on a step-by-step basis.

For each segment, you can either:

- play the segment from 1 to 1,000,000 times and then advance to the next step
- play the segment once and then stop and wait for a trigger before advancing
- repeat the segment until a trigger occurs and then advance
- repeat the segment until explicitly stopped

Options for **Sync** signal generation include:

- assert **Sync** at the beginning of the segment
- negate **Sync** at the beginning of the segment
- maintain the current **Sync** state throughout the segment
- assert **Sync** at the beginning of the segment and negate it at a defined point within the segment

To start a sequence on a trigger, place a brief DC waveform of 0 V (or any other desired value) in front of the other waveforms in the sequence, and set the segment to wait for a trigger before advancing. For 33500 Series instruments, the minimum segment length is 8 Sa, and for 33600 Series instruments, the minimum segment length is 32 Sa.

### NOTE

If a segment is set up to repeat until a trigger is received, the segment will always finish before continuing to the next segment. In addition, a short segment may repeat for additional cycles in order to clear the sequence sample buffer before continuing.

## Quasi-Gaussian Noise

The Noise waveform is optimized for both quantitative and qualitative statistical properties. It does not repeat for more than 50 years of continuous operation. Unlike a true gaussian distribution, there is zero probability of getting a voltage beyond the instrument's  $V_{pp}$  setting. The crest factor (peak voltage divided by RMS voltage) is approximately 4.6.

You can vary the Noise bandwidth from 1 MHz to the instrument's maximum bandwidth. The energy in the noise signal is concentrated in a band from DC to the selected bandwidth, so the signal has greater spectral density in the band of interest when the bandwidth setting is lower. In audio work, for example, you might set the bandwidth to 30 kHz, to make the audio band signal strength 30 dB higher than if the bandwidth were set to 30 MHz.

## PRBS

A Pseudo-Random Bit Sequence (PRBS) has two levels (high and low), and it switches between them in a manner that is difficult to predict without knowing the sequence generation algorithm. A PRBS is generated by a linear-feedback shift register (LFSR), shown below.

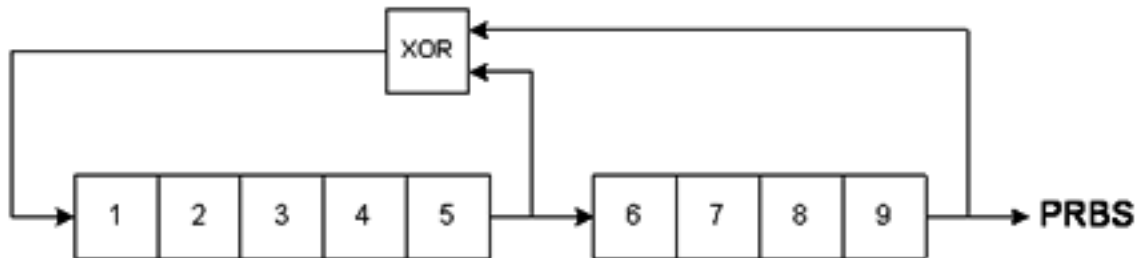

An LFSR is specified by the number of stages it contains and which stages ("taps") feed the exclusive-or (XOR) gates in its feedback network. The PRBS output is taken from the last stage. With properly chosen taps, an L-stage LFSR produces a repetitive PRBS of length  $2^L - 1$ . The clocking frequency of the LFSR determines the "bit rate" of the PRBS.

The 33500 Series models allow you to set L to 7, 9, 11, 15, 20, or 23, resulting in sequences from 127 to 8,388,607 bits in length.

The 33600 Series models allow you to set L to any whole number value from 3 to 32, resulting in sequences from 7 to 4,294,967,295 bits in length.

The default value for L is 7, resulting in a sequence of 127 bits in length.

## Modulation

### Amplitude Modulation (AM)

The instrument implements two forms of AM:

- Double-sideband full-carrier (DSB-FC), which has an ITU designation of A3E and is used in AM broadcasting.

The equation for DSB-FC is

$$y(t) = [(1/2) + (1/2) \cdot d \cdot m(t)] \cdot A_c \cdot \sin(\omega_c t)$$

where

$m(t)$  is the modulating signal

$A_c$  is the carrier amplitude

$\omega_c$  is the carrier frequency of the carrier

$d$  is the "modulation depth," or fraction of the amplitude range is used by the modulation

For example, a depth setting of 80% varies the amplitude from 10% to 90% of the amplitude setting (90% - 10% = 80%) with either an internal or a full-scale ( $\pm 5$  V on the 33500 Series,  $\pm 5$  V or  $\pm 1$  V on the 33600 Series) external modulating signal. You may set depth as high as 120%, as long as you do not exceed the instrument's maximum output voltage of ( $\pm 5$  V into 50  $\Omega$ ,  $\pm 10$  V into high impedance).

The top trace below represents the modulating signal; the bottom trace represents the modulated carrier.

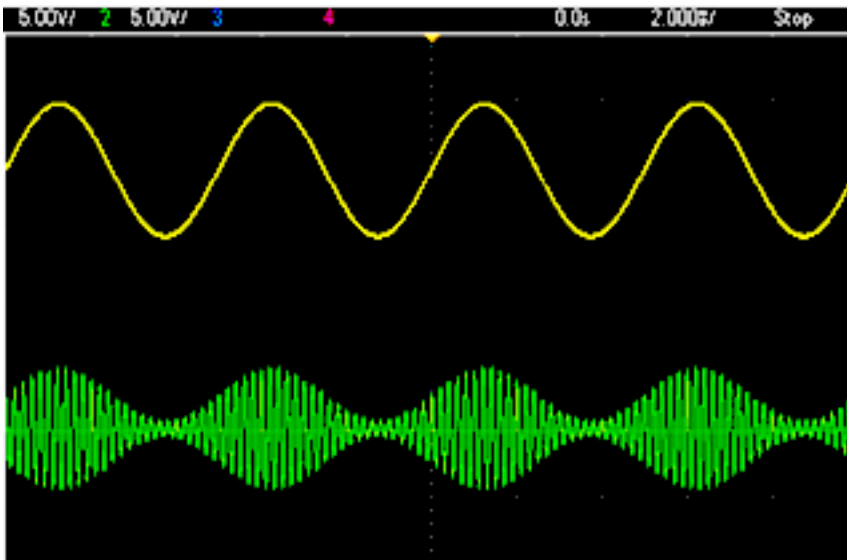

- Double-sideband suppressed-carrier (DSSC). Many modern communications systems employ DSSC on each of two carriers that have the same frequency but a 90-degree phase difference. This is called quadrature amplitude modulation (QAM).

The equation for DSSC is  $y(t)=d \cdot m(t) \cdot \sin(\omega_c t)$

In DSB-SC, the carrier signal is inverted whenever  $m(t) < 0$ . For QAM, the second carrier signal would be  $\cos(\omega_c t)$ , making it 90 degrees out of phase from the first carrier.

### Frequency Modulation (FM)

Frequency modulation varies a carrier signal's frequency according to the modulating signal:

$$y(t)=A_c \cdot \sin[(\omega_c+d \cdot m(t)) \cdot t]$$

where  $m(t)$  is the modulating signal and  $d$  is the frequency deviation. FM is called narrowband if the deviation is less than 1% of the modulating signal's bandwidth, and wideband otherwise. You can approximate the modulated signal's bandwidth with the following equations.

$BW \approx 2 \cdot (\text{Modulating Signal Bandwidth})$  for narrowband FM

$BW \approx 2 \cdot (\text{Deviation}+\text{Modulating Signal Bandwidth})$  for wideband FM

The top trace below represents the modulating signal; the bottom trace represents the modulated carrier.

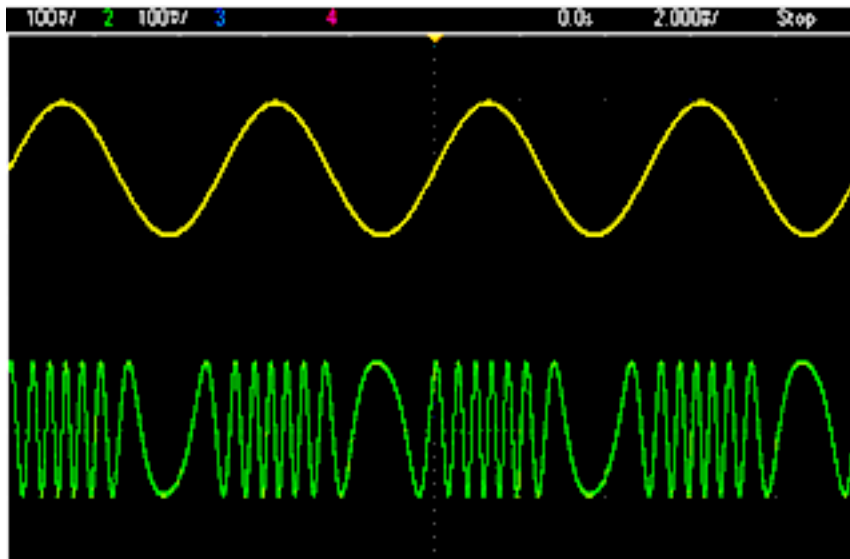

### Phase Modulation (PM)

PM is similar to FM, but the phase of the carrier waveform is varied, rather than the frequency:

$$y(t)=\sin[\omega_c t+d \cdot m(t)]$$

where  $m(t)$  is the modulating signal and  $d$  is the phase deviation.

### Frequency-Shift Keying (FSK) Modulation

FSK is similar to FM, except the carrier frequency alternates between two preset values, the carrier frequency and the hop frequency. Sometimes the hop and carrier frequencies are called "Mark" and "Space," respectively. The rate at which the switching between these values occurs is determined by an internal timer or the signal on the rear-panel **Ext Trig** connector. Frequency changes are instantaneous and phase-continuous.

The internal modulating signal is a square wave with 50% duty cycle.

The top trace below represents the modulating signal; the bottom trace represents the modulated carrier.

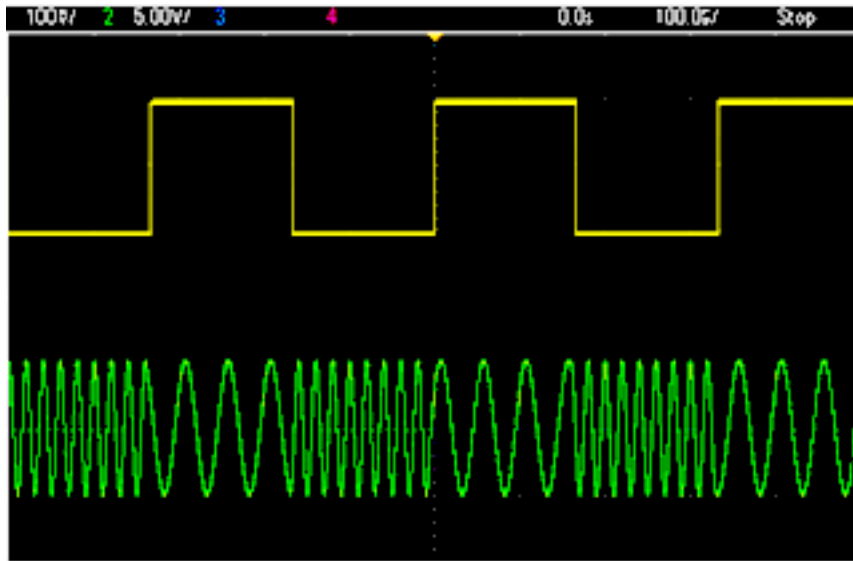

### Binary Phase Shift Keying (BPSK)

BPSK is similar to FSK, except it is the carrier's phase, rather than its frequency, that switches between two values. The rate at which the switching between these values occurs is determined by an internal timer or the signal on the rear-panel **Ext Trig** connector. Phase changes are instantaneous.

The internal modulating signal is a square wave with 50% duty cycle.

### Pulse Width Modulation (PWM)

PWM is only available for the Pulse waveform, and the pulse width varies according to the modulating signal. The amount by which the pulse width varies is called the width deviation, and it can be specified as a percentage of the waveform period (that is, duty cycle) or in units of time. For example, if you specify a pulse with 20% duty cycle and then enable PWM with a 5% deviation, the duty cycle varies from 15% to 25% under control of the modulating signal.

**Additive Modulation (Sum)**

The "Sum" feature adds the modulating signal to the carrier. For example, you can add controlled amounts of variable-bandwidth noise to a signal or create two-tone signals. The instrument's internal modulation generator can produce the same continuous waveform as the main generator, so the Sum function lets you to create many signals that would have required two instruments before.

The Sum feature increases the amplitude of the output signal by the amplitude of the modulating signal. This might cause the instrument to switch to a higher output-voltage range, resulting in a momentary signal loss. If this is a problem in your application, turn on the Range Hold function. If the voltage increase could damage your device under test, apply Voltage Limits.

## Burst

You can configure the instrument to output a waveform for a specified number of cycles, called a burst. You can use burst in one of two modes: N-Cycle Burst (also called "triggered burst") or Gated Burst.

An N-Cycle burst consists of a specific number of waveform cycles (1 to 1,000,000) and is always initiated by a trigger event. You can also set the burst count to "Infinite," which results in a continuous waveform once the instrument is triggered.

In the image below, the top trace is the sync output, and the bottom one is the main output.

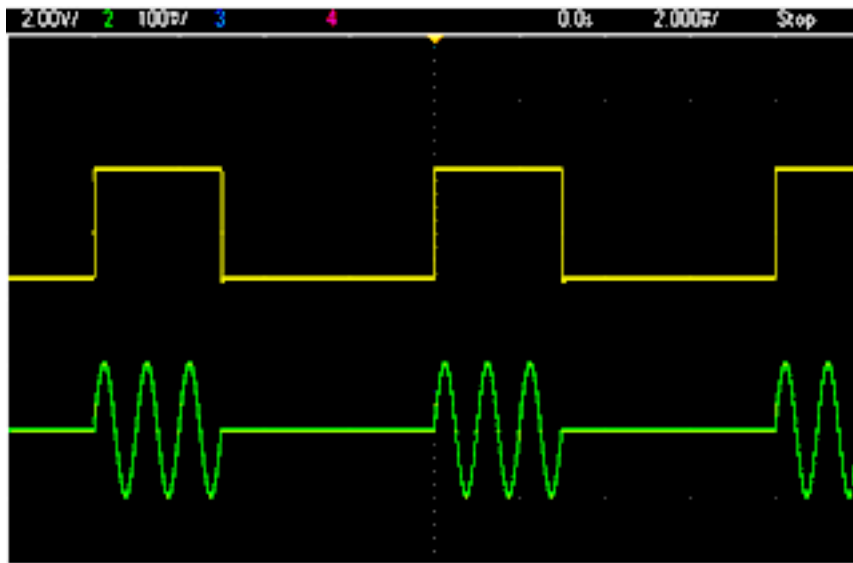

### Three-Cycle Burst Waveform

For bursts, the trigger source can be an external signal, an internal timer, the key, or a command from the remote interface. The input for external trigger signals is the rear-panel **Ext Trig** connector. This connector is referenced to chassis ground (not floating ground). When not used as an input, the **Ext Trig** connector can be configured as an output to enable the instrument to trigger other instruments at the same time that its internal trigger occurs.

An N-Cycle burst always begins and ends at the same point in the waveform, called the start phase.

In GATed burst mode, the output waveform is on or off, based on the signal at the rear-panel **Ext Trig** connector. Select this signal's polarity using **BURSt:GATE:POLarity**. When the gate signal is true, the instrument outputs a continuous waveform. When the gate signal goes false, the current waveform cycle is completed and the instrument stops and remains at the voltage level corresponding to the waveform's starting burst phase. For a noise waveform, the output stops immediately when the gate signal goes false.

## Frequency Sweep

Frequency sweeping is similar to FM, but no modulating waveform is used. Instead, the instrument sets the output frequency based on either a linear or logarithmic function, or a list of up to 128 user-specified frequencies. A linear sweep changes the output frequency by a constant number of Hz per second, and a logarithmic sweep changes the frequency by a constant number of decades per second. Logarithmic sweeps let you cover wide frequency ranges where resolution at low frequencies could be lost with a linear sweep.

Frequency sweeps are characterized by a sweep time (during which the frequency changes smoothly from the start frequency to the stop frequency), a hold time (during which the frequency stays at the stop frequency), and a return time (during which the frequency returns smoothly and linearly to the start frequency). Trigger settings determine when the next sweep begins.

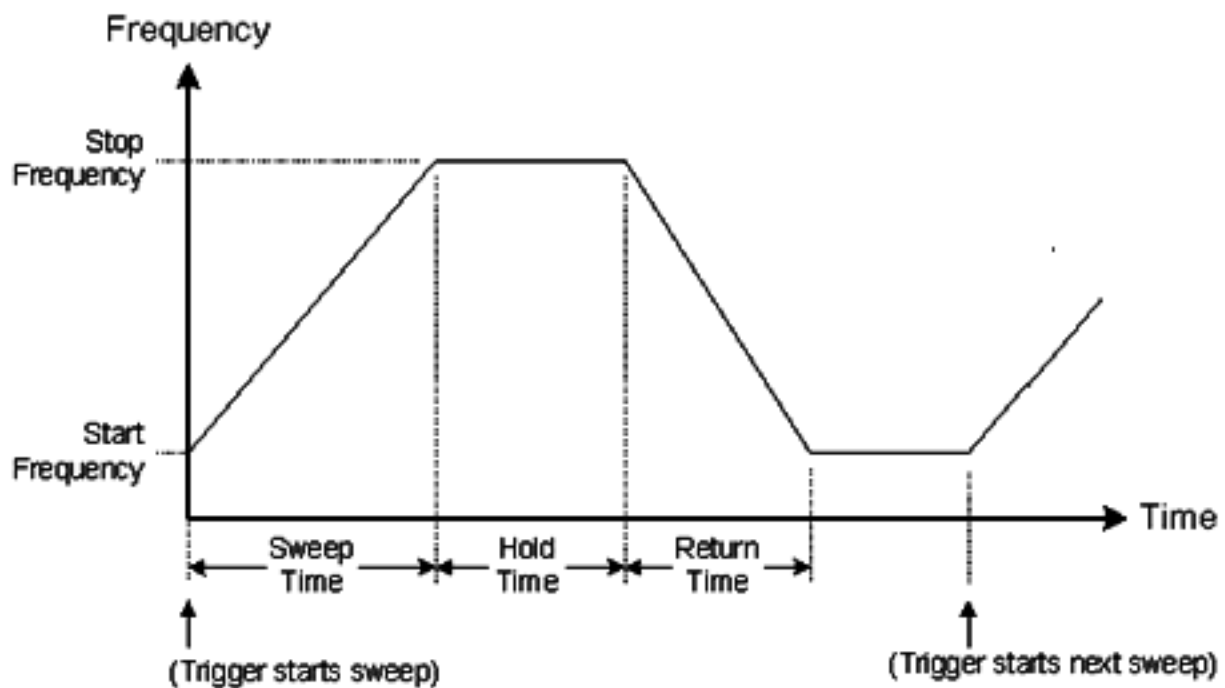



### Attributes of AC Signals

The most common AC signal is a sine wave. In fact, any periodic signal can be represented as the sum of different sine waves. The magnitude of a sine wave is usually specified by its peak, peak-to-peak, or root-mean-square (RMS) value. All of these measures assume that the waveform has zero offset voltage.

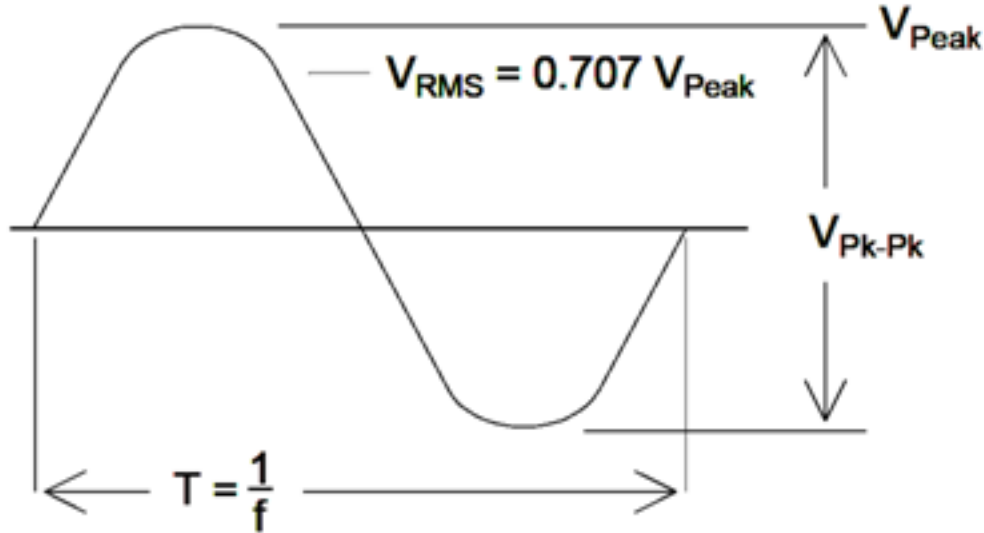

A waveform's peak voltage is the maximum absolute value of all of its points. The peak-to-peak voltage is the difference between the maximum and minimum. The RMS voltage equals the standard deviation of all waveform points; it also represents the one-cycle average power in the signal, minus the power in any DC component of the signal. Crest factor is the ratio of a signal's peak value to its RMS value and varies according to waveshape. The table below shows several common waveforms with their respective crest factors and RMS values.

Waveform Shape	Crest Factor (C.F.)	AC RMS	AC+DC RMS
	1.414	$\frac{V}{1.414}$	$\frac{V}{1.414}$
	1.732	$\frac{V}{1.732}$	$\frac{V}{1.732}$
	$\sqrt{\frac{T}{t}}$	$\frac{V}{C.F.} \times \sqrt{1 - \left(\frac{1}{C.F.}\right)^2}$	$\frac{V}{C.F.}$

If an average-reading voltmeter is used to measure the "DC voltage" of a waveform, the reading may not agree with the DC Offset setting. This is because the waveform may have a non-zero average value that would be added to the DC Offset.

You may occasionally see AC levels specified in "decibels relative to 1 milliwatt" (dBm). Since dBm represents a power level, you need to know the signal's RMS voltage and the load resistance in order to make the calculation.

$$\text{dBm} = 10 \times \log_{10} (P / 0.001) \text{ where } P = V_{\text{RMS}}^2 / R_L$$

For a sine wave into a 50  $\Omega$  load, the following table relates dBm to voltage.

<b>dBm</b>	<b>RMS Voltage</b>	<b>Peak-to-Peak Voltage</b>
+23.98 dBm	3.54 Vrms	10.00 Vpp
+13.01 dBm	1.00 Vrms	2.828 Vpp
+10.00 dBm	707 mVrms	2.000 Vpp
+6.99 dBm	500 mVrms	1.414 Vpp
3.98 dBm	354 mVrms	1.000 Vpp
0.00 dBm	224 mVrms	632 mVpp
-6.99 dBm	100 mVrms	283 mVpp
-10.00 dBm	70.7 mVrms	200 mVpp
-16.02 dBm	35.4 mVrms	100 mVpp
-30.00 dBm	7.07 mVrms	20.0 mVpp
-36.02 dBm	3.54 mVrms	10.0 mVpp
-50.00 dBm	0.707 mVrms	2.00 mVpp
-56.02 dBm	0.354 mVrms	1.00 mVpp

For 75  $\Omega$  or 600  $\Omega$  loads, use the following conversions:

$$\text{dBm (75 } \Omega) = \text{dBm (50 } \Omega) - 1.76$$

$$\text{dBm (600 } \Omega) = \text{dBm (50 } \Omega) - 10.79$$

### Signal Imperfections

For sine waves, common signal imperfections are easiest to describe and observe in the frequency domain, using a spectrum analyzer. Any output signal component with a frequency different from the fundamental (or "carrier") is considered to be distortion. Those imperfections can be categorized as harmonic distortion, non-harmonic spurious, or phase noise, and they are specified in decibels relative to the carrier level, or "dBc."

#### Harmonic Distortion

Harmonic components occur at integer multiples of the fundamental frequency and are usually created by non-linear components in the signal path. At low signal amplitudes, another possible source of harmonic distortion is the **Sync** signal, which is a square wave with many strong harmonic components that can couple into the main signal. Although **Sync** is highly isolated from the instrument's main signal outputs, coupling can occur in external cabling. For best results, use high-quality coaxial cables with double or triple shields. If **Sync** is not required, leave it unconnected or off.

#### Non-Harmonic Spurious

One source of non-harmonic spurious components (called "spurs") is the digital-to-analog converter (DAC) that converts the digital waveform values into voltage. Non-linearity in this DAC gives rise to harmonics that can be higher than the Nyquist frequency and will therefore be aliased to a lower frequency. For example, the fifth harmonic of 30 MHz (150 MHz) could create a spur at 100 MHz.

Another source of non-harmonic spurs is the coupling of unrelated signal sources (such as the embedded controller's clocks) into the output signal. These spurs usually have constant amplitude and are most troublesome at signal amplitudes below 100 mVpp. For optimal signal purity at low amplitudes, keep the instrument's output level relatively high and use an external attenuator.

#### Phase Noise

Phase noise results from small, instantaneous changes in the output frequency ("jitter"). On a spectrum analyzer, it appears as a rise in the apparent noise floor near the frequency of the output signal. The phase noise specification represents the amplitudes of the noise in 1 Hz bands located 1 kHz, 10 kHz, and 100 kHz away from a 30-MHz sine wave. Be aware that spectrum analyzers also have phase noise, so the levels you read may include analyzer phase noise.

#### Quantization Noise

Finite resolution in the waveform DAC causes voltage quantization errors. Assuming the errors are uniformly distributed over a range of  $\pm 0.5$  least-significant bit, the equivalent noise level for standard waveforms is approximately -95 dBc. At this level, other sources of noise in the instrument dominate. Quantization noise can be of concern, though, in arbitrary waveforms that do not use the whole range of DAC codes (-32767 to +32767). Scale arbitrary waveforms to use the entire range, if possible.

## Ground Loops

The signal-generation portion of the instrument is isolated from chassis (earth) ground. This helps eliminate ground loops in your system and also allows you to reference the output signal to voltages other than ground. The illustration below shows the instrument connected to a load through a coaxial cable. Any difference in ground potentials ( $V_{GND}$ ) will tend to drive current  $I_{GND}$  through the shield of the cable, thus causing a voltage drop due to the shield's impedance ( $Z_{SHIELD}$ ). This voltage ( $I_{GND} \times Z_{SHIELD}$ ) appears as an error in the load voltage. However, since the instrument is isolated, there is a high series impedance (typically  $>1 \text{ M}\Omega$ ) in parallel with  $50 \text{ nF}$  to oppose the flow of  $I_{GND}$  and thereby minimize this effect.

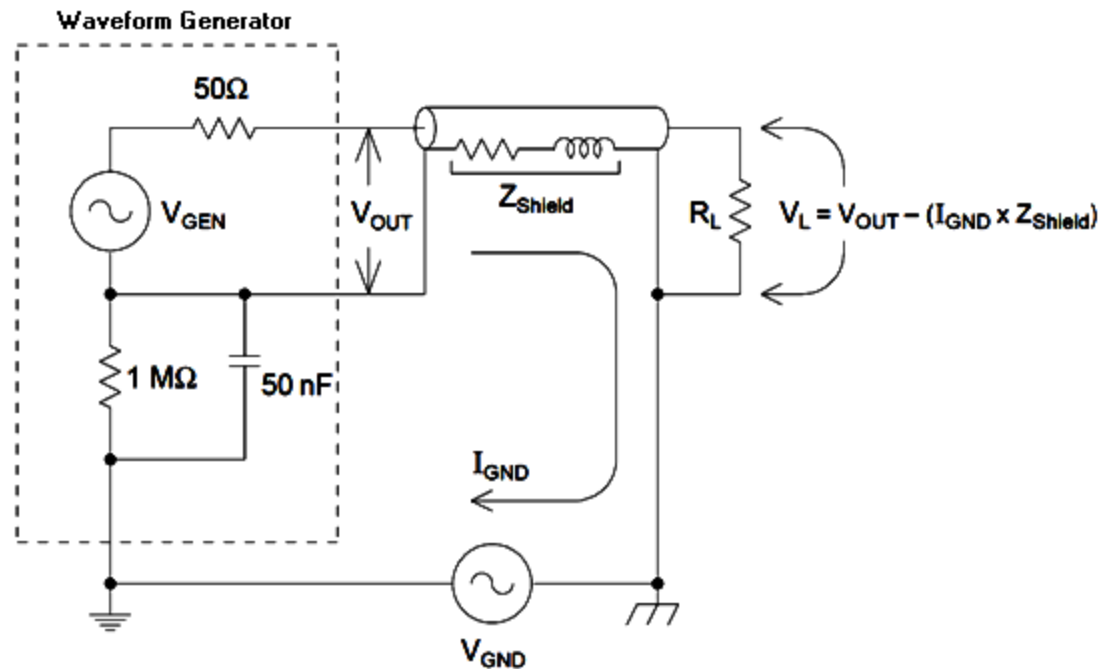

At frequencies above a few kHz, a coaxial cable's shield becomes inductive, rather than resistive, and the cable begins to act like a transformer. When this happens, voltage drops in the shield due to  $I_{GND}$  tend to be offset by equal voltages in the center conductor, thereby reducing the effects of ground loops at higher frequencies. Coaxial cables with two or three braided shields are much better than those with single- braided or foil shields because they have lower resistance and therefore become transformers at lower frequencies.

To reduce errors due to ground loops, connect the instrument to the load using a high-quality coaxial cable and ground it at the load through the cable's shield. If possible, make sure the instrument and the load are connected to the same electrical outlet to minimize further differences in ground potential.

Be aware that the outer shells of the **Sync** and **Modulation In** connectors are connected to those of the main output connector(s). Cables attached to **Sync** and/or **Modulation In** are therefore potential sources of ground loops. Also be aware that attempting to drive those connector shells to different voltages can cause high current to flow through the instrument, possibly causing damage.



# SCPI Programming Reference

This section describes the SCPI programming language for the instrument.

[Introduction to SCPI Language](#)

[Internal Function Waveforms](#)

[Alphabetical List of SCPI Commands and Queries](#)

[Programming Examples](#)

[Command Quick Reference](#)

[Factory Reset State](#)

[SCPI Error Messages](#)

## Introduction to the SCPI Language

SCPI (Standard Commands for Programmable Instruments) is an ASCII-based instrument command language designed for test and measurement instruments. SCPI commands are based on a hierarchical structure, also known as a *tree system*. In this system, associated commands are grouped together under a common node or root, thus forming *subsystems*. A portion of the OUTPUT subsystem is shown below to illustrate the tree system.

OUTPut:

    SYNC {OFF|0|ON|1}

        SYNC:

            MODE {NORMal|CARRier}

            POLarity {NORMal|INVerted}

**OUTPut** is the root keyword, **SYNC** is a second-level keyword, and **MODE** and **POLarity** are third-level keywords. A colon (:) separates a command keyword from a lower-level keyword.

## Syntax Conventions

The format used to show commands is illustrated below:

[SOURce[1|2]:]VOLTage:UNIT {VPP|VRMS|DBM}

[SOURce[1|2]:]FREQuency:CENTer {<frequency>|MINimum|MAXimum|DEFault}

The command syntax shows most commands (and some parameters) as a mixture of upper- and lower-case letters. The upper-case letters indicate the abbreviated spelling for the command. For shorter program lines, you can send the abbreviated form. For better program readability, you can send the long form.

For example, in the above syntax statement, VOLT and VOLTAGE are both acceptable forms. You can use upper- or lower-case letters. Therefore, VOLTAGE, volt, and Volt are all acceptable. Other forms, such as VOL and VOLTAG, are not valid and will generate an error.

- Braces ( { } ) enclose the parameter choices for a given command string. The braces are not sent with the command string.
- A vertical bar ( | ) separates multiple parameter choices for a given command string. For example, {VPP|VRMS|DBM} in the above command indicates that you can specify "VPP", "VRMS", or "DBM". The bar is not sent with the command string.
- Triangle brackets in the second example ( < > ) indicate that you must specify a value for the enclosed parameter. For example, the above syntax statement shows the <frequency> parameter enclosed in triangle brackets. The brackets are not sent with the command string. You must specify a value for the parameter (for example "FREQ:CENT 1000") unless you select another option shown in the syntax (for example "FREQ:CENT MIN").
- Some syntax elements (for example nodes and parameters) are enclosed in square brackets ( [ ] ). This indicates that the element is optional and can be omitted. The brackets are not sent with the command string. If you do not specify a value for an optional parameter, the instrument chooses a default value. In the examples above the "SOURce[1|2]" indicates that you may refer to source channel 1 either by "SOURce", or by "SOURce1", or by "SOUR1" or by "SOUR". In addition, since the whole SOURce node is optional (in brackets) you also may refer to channel 1 by entirely leaving out the SOURce node. This is because Channel 1 is the default channel for the SOURce language node. On the other hand, to refer to Channel 2, you must use either "SOURce2" or "SOUR2" in your program lines.

## Command Separators

A colon ( : ) is used to separate a command keyword from a lower-level keyword. You must insert a blank space to separate a parameter from a command keyword. If a command requires more than one parameter, you must separate adjacent parameters using a comma as shown below:

```
APPL:SIN 455E3,1.15,0.0
```

In this example, the APPLy command is specifying a sine wave at a frequency of 455 KHz, with an amplitude of 1.15 volts, and a DC offset of 0.0 volts.

A semicolon ( ; ) is used to separate commands within the same subsystem, and can also minimize typing. For example, sending the following command string:

```
TRIG:SOUR EXT; COUNT 10
```

is the same as sending the following two commands:

```
TRIG:SOUR EXT
TRIG:COUNT 10
```

## Using the MIN, MAX, and DEF Parameters

For many commands, you can substitute "MIN" or "MAX" in place of a parameter. In some cases you may also substitute "DEF". For example, consider the following command:

```
[SOURce[1|2]:]APPLY:DC [{<frequency>|DEF} [,{<amplitude>|DEF} [,{<offset>|MIN|MAX|DEF}]]]
```

Instead of selecting a specific value for the *<offset>* parameter, you can substitute MIN to set the offset to its minimum value, MAX to set the offset to its maximum value. You can also specify DEF to set the default value for each parameter: *<frequency>*, *<amplitude>*, and *<offset>*.

## Querying Parameter Settings

You can query the current value of most parameters by adding a question mark ( ? ) to the command. For example, the following command sets the trigger count to 10 readings:

```
TRIG:COUN 10
```

You can then query the count value by sending:

```
TRIG:COUN?
```

You can also query the minimum or maximum count allowed as follows:

```
TRIG:COUN? MIN
TRIG:COUN? MAX
```

## SCPI Command Terminators

A command string sent to the instrument must terminate with a *<new line>* (*<NL>*) character. The IEEE-488 EOI (End-Of-Identify) message is interpreted as a *<NL>* character and can be used to terminate a command string in place of a *<NL>* character. A *<carriage return>* followed by a *<NL>* is also accepted. Command string termination will always reset the current SCPI command path to the root level.

### NOTE

For every SCPI message that includes a query and is sent to the instrument, the instrument terminates the returned response with a *<NL>* or line-feed character (EOI). For example, if "DISP:TEXT?" is sent, the response is terminated with a *<NL>* after the string of data that is returned. If a SCPI message includes multiple queries separated by semicolons (for example "DISP?;DISP:TEXT?"), the returned response is again terminated by a *<NL>* after the response to the last query. In either case, the program must read this *<NL>* in the response before another command is sent to the instrument, or an error will occur.

## IEEE-488.2 Common Commands

The IEEE-488.2 standard defines a set of common commands that perform functions such as reset, self-test, and status operations. Common commands always begin with an asterisk ( \* ), are three characters in length, and may include one or more parameters. The command keyword is separated from the first parameter by a blank space. Use a semicolon ( ; ) to separate multiple commands as shown below:

```
*RST; *CLS; *ESE 32; *OPC?
```



## SCPI Parameter Types

The SCPI language defines several data formats to be used in program messages and response messages.

### Numeric Parameters

Commands that require numeric parameters will accept all commonly used decimal representations of numbers including optional signs, decimal points, and scientific notation. Special values for numeric parameters such as MIN, MAX, and DEF are also accepted. You can also send engineering unit suffixes with numeric parameters (e.g., M, k, m, or u). If a command accepts only certain specific values, the instrument will automatically round the input numeric parameters to the accepted values. The following command requires a numeric parameter for the frequency value:

```
[SOURce[1|2]:]FREQuency:CENTer {<frequency>|MINimum|MAXimum}
```

#### NOTE

Because the SCPI parser is case-insensitive, there is some confusion over the letter "M" (or "m"). For your convenience, the instrument interprets "mV" (or "MV") as millivolts, but "MHZ" (or "mhz") as megahertz. Likewise "MΩ" (or "mΩ") is interpreted as megohms. You can use the prefix "MA" for mega. For example, "MAV" is interpreted as megavolts.

### Discrete Parameters

Discrete parameters are used to program settings that have a limited number of values (like IMMEDIATE, EXTERNAL, or BUS). They may have a short form and a long form just like command keywords. You can mix upper- and lower-case letters. Query responses will always return the short form in all upper-case letters. The following command requires a discrete parameter for the voltage units:

```
[SOURce[1|2]:]VOLTage:UNIT {VPP|VRMS|DBM}
```

### Boolean Parameters

Boolean parameters represent a single binary condition that is either true or false. For a false condition, the instrument will accept "OFF" or "0". For a true condition, the instrument will accept "ON" or "1". When you query a Boolean setting, the instrument will always return "0" or "1". The following command requires a Boolean parameter:

```
DISPlay {OFF|0|ON|1}
```

### ASCII String Parameters

String parameters can contain virtually any set of ASCII characters. A string must begin and end with matching quotes; either with a single quote or a double quote. You can include the quote delimiter as part of the string by typing it twice without any characters in between. The following command uses a string parameter:

DISPlay:TEXT <quoted string>

For example, the following command displays the message "WAITING..." on the instrument's front panel (the quotes are not displayed).

```
DISP:TEXT "WAITING..."
```

You can also display the same message using single quotes.

```
DISP:TEXT 'WAITING...'
```

## Using Device Clear

Device Clear is an IEEE-488 low-level bus message that you can use to return the instrument to a responsive state. Different programming languages and IEEE-488 interface cards provide access to this capability through their own unique commands. The status registers, the error queue, and all configuration states are left unchanged when a Device Clear message is received.

Device Clear performs the following actions:

- If a measurement is in progress, it is aborted.
- The instrument returns to the trigger "idle" state.
- The instrument's input and output buffers are cleared.
- The instrument is prepared to accept a new command string.

### NOTE

The **ABORT** command is the recommended method to terminate an instrument operation.

## Internal Function Waveforms

The following are the internal function waveforms.

- **SINusoid**: a sine wave, no phase shift.

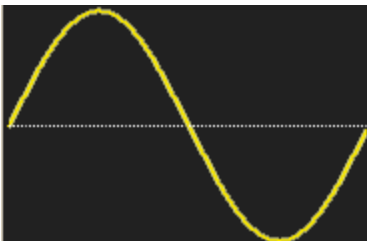

- **SQUare**: a square wave, 50% duty cycle.



- **RAMP**: ramp, 100% symmetry.



- **NRAMP**: negative ramp, 0% symmetry.

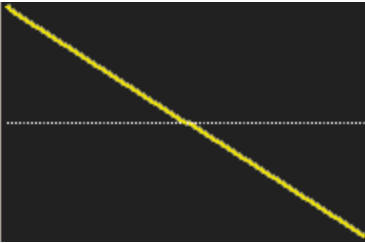

- **TRiangle**: ramp, 50% symmetry.

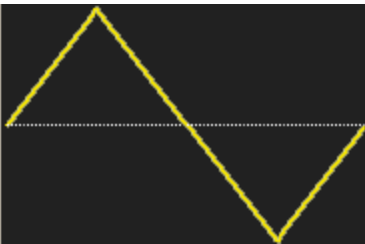

- **NOISE**: gaussian noise; if NOISE is the internal function, it cannot also be the carrier.

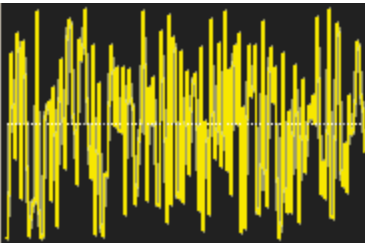

- **PRBS:** pseudo-random binary sequence modulation; if PRBS is the internal function, it cannot also be the carrier.

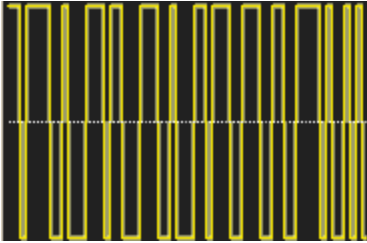

- **ARbitrary:** arbitrary waveform; default is exponential rise; if ARB is the internal function, it cannot also be the carrier.

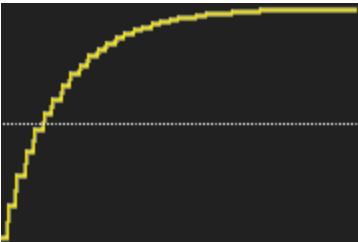

## See Also

[AM Subsystem](#)  
[FM Subsystem](#)  
[PM Subsystem](#)  
[PWM Subsystem](#)  
[SUM Subsystem](#)

## Alphabetical List of SCPI Commands and Queries

[ABORT](#)  
[AM Subsystem](#)  
[APPLY Subsystem](#)  
[BPSK Subsystem](#)  
[BURSt Subsystem](#)  
[CALibration Subsystem](#)  
[COMBine:FEED](#)  
[DATA Subsystem](#)  
[DISPlay Subsystem](#)  
[FM Subsystem](#)  
[FORMat:BORDER](#)  
[FREQuency Subsystem](#)  
[FSKey Subsystem](#)  
[FUNction Subsystem](#)  
[HCOPY Subsystem](#)  
[IEEE-488.2 Common Commands](#)

## SCPI Programming Reference

INITiate Subsystem

INPut\_ATTenuation\_STATe

LIST Subsystem

LXI Subsystem

MARKer Subsystem

MEMory Subsystem

MMEMory Subsystem

OUTPut Subsystem

PHASe Subsystem

PM Subsystem

PWM Subsystem

RATE Subsystem

ROSC Subsystem

SOURce Subsystem

STATus Subsystem

SUM Subsystem

SWEEp Subsystem

SYSTem Subsystem

SYSTem: LAN Configuration

TRACk

TRIGger Subsystem

UNIT:ANGLE

UNIT:ARbitrary:ANGLE

VOLTage Subsystem

## ABORt

Halts a sequence, list, sweep, or burst, even an infinite burst. Also causes trigger subsystem to return to idle state. If **INITiate:CONTinuous** is ON, instrument immediately proceeds to wait-for-trigger state.

Parameter	Typical Return
(none)	(none)
Halt the items listed above: ABORt	

- Halts any triggered action (triggered list, triggered sweep, triggered burst, triggered arbitrary waveform playback).
- ABORt has no effect when instrument is in normal or modulated modes, except for sequenced arbitrary waveforms, lists, bursts, and sweeps. If instrument is running a sequence, list, burst, or sweep, ABORt restarts the stopped item with the current **INIT** and trigger conditions.
- When ABORt occurs in list mode, the frequency goes back to the "normal" mode frequency until the first trigger occurs. After the first trigger, the first frequency in the list will be used.
- If ABORt executed during sweep, sweep returns to starting sweep frequency.
- ABORt always applies to both channels in a two-channel instrument.

## AM Subsystem

The AM subsystem allows you to add amplitude modulation (AM) to a carrier waveform.

### Example

To generate an amplitude modulation (AM) waveform:

1. **Configure carrier waveform:** Use **FUNCTION**, **FREQUENCY**, **VOLTage**, and **VOLTage:OFFSet** to specify the carrier waveform's function, frequency, amplitude, and offset.
2. **Select mode of Amplitude Modulation:** **AM:DSSC**
3. **Select modulation source (internal, external, CH1, or CH2):** **AM:SOURce**. For an external source, you can skip steps 4 and 5 below.
4. **Select modulating waveform:** **AM:INTernal:FUNCTION**
5. **Set modulating frequency:** **AM:INTernal:FREQUENCY**
6. **Set modulation depth:** **AM[:DEPTH]**
7. **Enable AM:** **AM:STATe:ON**

The following code produces the oscilloscope image shown below.

```
FUNCTION SQU
FREQUENCY +1.0E+04
VOLTage +1
```

```
VOLTage:OFFset 0.0
AM:SOURce INT
AM:DSSC 0
AM:DEPT h +120
AM:INTernal:FUNCT ion TRI
AM:INTernal:FREQ 5E+02
AM:STATe 1
OUTPut1 1
```

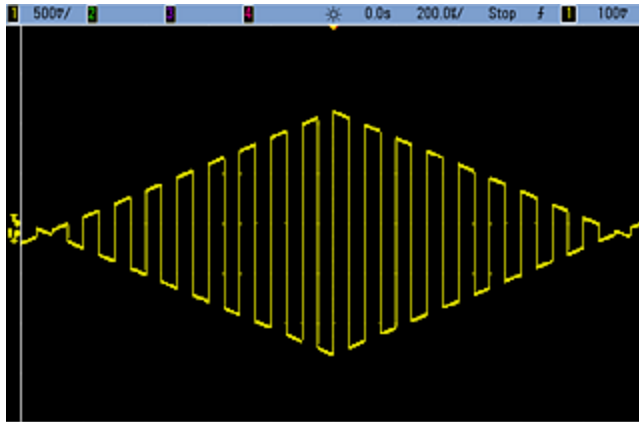

[SOURce[1|2]:]AM[:DEPT h] {<depth\_in\_percent>|MINimum|MAXimum}  
[SOURce[1|2]:]AM[:DEPT h]? [{MINimum|MAXimum}]

Sets internal modulation depth ("percent modulation") in percent.

Parameter	Typical Return
0 to 120, default 100	+5.0000000000000000E+01
Set the internal modulation depth to 50%: AM:DEPT 50	
Set the internal modulation depth to 120%: AM:DEPT MAX	

- Even at greater than 100% depth, the instrument will not exceed  $\pm 5$  V peak on the output (into a 50  $\Omega$  load). To achieve modulation depth greater than 100%, output carrier amplitude may be reduced.
- With AM:SOURce EXTERNAL, carrier waveform is modulated with an external waveform. The modulation depth is controlled by the  $\pm 5$  V signal level (or the optional  $\pm 1$  V signal level on the 33600 Series) on the rear-panel **Modulation In** connector. For example, if modulation depth (AM[:DEPT h]) is 100%, then when the modulating signal is at +5 V (or optionally +1 V on the 33600 Series), the output will be at the maximum amplitude. Similarly, a -5 V modulating signal (or optionally -1 V on the 33600 Series) produces output at minimum amplitude.

**See Also**

INPut:ATTenuation[:STATe]

[SOURce[1|2]:]AM:DSSC {ON|1|OFF|0}  
[SOURce[1|2]:]AM:DSSC?

Selects Amplitude Modulation mode – Double Sideband Suppressed Carrier (ON) or AM modulated carrier with sidebands (OFF).

Parameter	Typical Return
{ON 1 OFF 0}	0 (OFF) or 1 (ON)
Set AM to DSSC mode: AM:DSSC ON	

- The power-on default value is OFF.
- In DSSC AM, zero modulation results in zero output signal, and increasing modulation input signal raises the amplitude of the sidebands in proportion to the amplitude of the modulating signal.
- DSSC AM is useful for some digital modulation modes.
- In "normal" AM, zero modulation results in a half-amplitude carrier wave signal being output. As modulation input signal rises, the carrier is amplitude modulated between 0 and 100% amplitude.
- In DSSC, the **AM[:DEPTH]** setting applies, and scales the modulation signal from 0 to 120% modulation.



[SOURCE[1|2]:]AM:INTernal:FREQUency {<frequency>|MINimum|MAXimum|DEFault}  
 [SOURCE[1|2]:]AM:INTernal:FREQUency? [{MINimum|MAXimum}]

Sets frequency of modulating waveform. The waveform chosen as modulating source will operate at that frequency, within waveform frequency limits.

Parameter	Typical Return
1 µHz to the <b>maximum allowed for the internal function</b> . Default 100 Hz	+1.0000000000000000E+04
Set the modulating frequency to 10 kHz: AM:INT:FUNC 10000	

- When you select an arbitrary waveform as the modulating source, the frequency changes to the frequency of the arbitrary waveform, which is based on the sample rate and the number of points in the arbitrary waveform.
- When using an arbitrary waveform for the modulating source, changing this parameter also changes the cached metadata representing the arbitrary waveform's sample rate. You can also change the modulating frequency of an arbitrary waveform with **FUNCTION:ARbitrary:FREQUency**, **FUNCTION:ARbitrary:PERiod**, and **FUNCTION:ARbitrary:SRATe**. These commands and the modulation frequency command are directly coupled in order to keep the arbitrary waveform behaving exactly as it was last played. If you later turn modulation off and select that same arbitrary waveform as the current function, its sample rate (and corresponding frequency based upon the number of points) will be the same as it was when played as the modulation source.
- If the internal function is TRiangle, UpRamp, or DnRamp, the maximum frequency is limited to 200 kHz on the 33500 Series or 800 kHz on the 33600 Series. If the internal function is PRBS, the frequency refers to bit rate and is limited **as shown here**.
- This command should be used only with the internal modulation source (**AM:SOURce INTernal**).

[SOURCE[1|2]:]AM:INTernal:FUNCtion <function>  
 [SOURCE[1|2]:]AM:INTernal:FUNCtion?

Selects shape of modulating waveform.

Parameter	Typical Return
{SINusoid SQUare RAMP NRAMp TRIangle NOISe PRBS ARB}, default SINusoid, default SINusoid. <b>View internal function waveforms.</b>	SIN, SQU, RAMP, NRAM, TRI, NOIS, PRBS, or ARB
Select a sine wave as the modulating waveform. AM:INT:FUNC SIN	

- This command should be used only with the internal modulation source (**AM:SOURce INTernal**).
- Pulse and DC cannot be carrier waveform for AM.

[SOURce[1|2]:]AM:SOURce {INTernal|EXTernal|CH1|CH2}  
[SOURce[1|2]:]AM:SOURce?

[SOURce[1|2]:]BPSK:SOURce {INTernal|EXTernal}  
[SOURce[1|2]:]BPSK:SOURce?

[SOURce[1|2]:]FM:SOURce {INTernal|EXTernal|CH1|CH2}  
[SOURce[1|2]:]FM:SOURce?

[SOURce[1|2]:]FSKey:SOURce {INTernal|EXTernal}  
[SOURce[1|2]:]FSKey:SOURce?

[SOURce[1|2]:]PM:SOURce {INTernal|EXTernal|CH1|CH2}  
[SOURce[1|2]:]PM:SOURce?

[SOURce[1|2]:]PWM:SOURce {INTernal|EXTernal|CH1|CH2}  
[SOURce[1|2]:]PWM:SOURce?

Selects the source of the modulating signal.

Parameter	Typical Return
{INTernal EXTernal CH1 CH2}, default INTernal. BPSK and FSKey cannot accept CH1 or CH2	INT, EXT, CH1, or CH2
Select external modulation source: AM:SOUR EXT (could also substitute FM, BPSK, FSK, PM, or PWM for AM)	

- If you select EXTERNAL, the carrier waveform is modulated with an external waveform. Specifically:
  - **AM:** The modulation depth is controlled by the  $\pm 5$  V signal level (or the optional  $\pm 1$  V signal level on the 33600 Series) on the rear-panel **Modulation In** connector. For example, if modulation depth (**AM[:DEPTH]**) is 100%, then when the modulating signal is at +5 V (or optionally +1 V on the 33600 Series), the output will be at the maximum amplitude. Similarly, a -5 V modulating signal (or optionally -1 V on the 33600 Series) produces output at minimum amplitude.
  - **FM:** If you select the *External* modulating source, the deviation is controlled by the  $\pm 5$  V signal level (optionally  $\pm 1$  V on the 33600 Series) on the rear-panel **Modulation In** connector. For example, if the frequency deviation is 100 kHz, then a +5 V signal level (optionally +1 V on the 33600 Series) corresponds to a 100 kHz increase in frequency. Lower external signal levels produce less deviation and negative signal levels reduce the frequency below the carrier frequency.
  - **PM:** With the External modulating source, deviation is controlled by the  $\pm 5$  V signal level (optionally  $\pm 1$  V on the 33600 Series) on the rear-panel **Modulation In** connector. For example, if you have set the frequency deviation to 180 degrees, then a +5 V signal level (optionally  $\pm 1$  V on the 33600 Series) corresponds to a +180 degree phase deviation. Lower external signal levels produce less deviation, and negative signal levels produce negative deviation.
  - **Pulse as Selected Function:** The pulse width or pulse duty cycle deviation is controlled by the  $\pm 5$  V signal level (optionally  $\pm 1$  V on the 33600 Series) present on the rear-panel **Modulation In** connector. For example, if you have set the pulse width deviation to 50  $\mu$ s using the **PWM:DEVIation** command, then a +5 V signal level (optionally +1 V on the 33600 Series) corresponds to a 50  $\mu$ s width increase. Lower external signal levels produce less deviation.
- With EXTERNAL source, the output phase (BPSK) or frequency (FSK) is determined by the signal level on the rear-panel **Ext Trig** connector. When a logic low is present, the carrier phase or carrier frequency is output. When a logic high is present, the phase shifted phase or hop frequency is output.
- The maximum external BPSK rate is 1 MHz, and the maximum FSK rate is 1 MHz.
- **Note:** the connector used for externally-controlled BPSK or FSK waveforms (**Trig In**) is not the same connector that is used for externally-modulated AM, FM, PM, and PWM waveforms (**Modulation In**). When used for BPSK or FSK, the **Trig In** connector does not have adjustable edge polarity and is not affected by the **TRIGger[1|2]:SLOPe** command.
- With INTERNAL source, the rate at which output phase (BPSK) or frequency (FSKey) "shifts" between the carrier phase or frequency and the alternate phase or frequency is determined by the BPSK rate (**BPSK:INTERNAL:RATE**) or FSK rate (**FSKey:INTERNAL:RATE**).
- A channel may not be its own modulation source.

## See Also

**INPut:ATTenuation[:STATe]**

**AM Subsystem**

**BPSK Subsystem**

**FM Subsystem**

**FSKey Subsystem**

**PM Subsystem**

**PWM Subsystem**

[SOURce[1|2]:]AM:STATe {ON|1|OFF|0}  
[SOURce[1|2]:]AM:STATe?

[SOURce[1|2]:]BPSK:STATe {ON|1|OFF|0}  
[SOURce[1|2]:]BPSK:STATe?

[SOURce[1|2]:]FM:STATe {ON|1|OFF|0}  
[SOURce[1|2]:]FM:STATe?

[SOURce[1|2]:]FSKey:STATe {ON|1|OFF|0}  
[SOURce[1|2]:]FSKey:STATe?

[SOURce[1|2]:]PM:STATe {ON|1|OFF|0}  
[SOURce[1|2]:]PM:STATe?

[SOURce[1|2]:]PWM:STATe {ON|1|OFF|0}  
[SOURce[1|2]:]PWM:STATe?

Enables or disables modulation.

Parameter	Typical Return
{ON 1 OFF 0}, default OFF	0 (OFF) or 1 (ON)
Enable AM (could also substitute FM, BPSK, FSK, PM, or PWM): AM:STAT ON	

- To avoid multiple waveform changes, enable modulation after configuring the other modulation parameters.
- Only one modulation mode may be enabled at a time.
- The instrument will not enable modulation with sweep or burst enabled. When you enable modulation, the sweep or burst mode is turned off.
- PWM is allowed only when pulse is the selected function.

#### See Also

[AM Subsystem](#)  
[PSK Subsystem](#)  
[FM Subsystem](#)  
[FSKey Subsystem](#)  
[PM Subsystem](#)  
[PWM Subsystem](#)

## APPLY Subsystem

The APPLY subsystem allows you to configure entire waveforms with one command. The general form of an APPLY command is shown below:

```
[SOURce[1|2]:]APPLY:<function> [<frequency> [,<amplitude> [,<offset>]]]
```

For example,

```
APPLY:SIN 1e4,1,0.1
```

replaces the following commands:

```
FUNCTION SIN  
FREQ 1e4  
VOLT 1  
VOLT:OFF 0.1  
OUTP ON
```

Not only is APPLY shorter, it avoids settings conflicts that occur when sending commands individually. In addition, **APPLY** performs the following operations:

- Sets trigger source to IMMEDIATE (equivalent to **TRIGGER[1|2]:SOURCE IMMEDIATE**).
- Turns off any modulation, sweep, or burst mode currently enabled and places the instrument in continuous waveform mode.
- Turns on the channel output (**OUTPUT ON**) without changing output termination setting (**OUTPUT [1|2]:LOAD**).
- Overrides the voltage autorange setting and enables autoranging (**VOLTAGE:RANGE:AUTO**).

The instrument can generate eight types of waveforms: DC voltage, gaussian noise, PRBS, pulse, ramp/triangle wave, sine wave, square wave and arbitrary (user) waveform. Waveform-specific settings exist in the **FUNCTION subsystem**.

You can also query current output configuration (**APPLY?**).

### General Remarks

#### Amplitude

- Changing amplitude may briefly disrupt output at certain voltages due to output attenuator switching. The amplitude is controlled, however, so the output voltage will never exceed the current setting while switching ranges. To prevent this disruption, disable voltage autoranging using **VOLTAGE:RANGE:AUTO OFF**. The **APPLY** command automatically enables autoranging.

- Limits Due to Output Termination: The offset range depends on the output termination setting. For example, if you set offset to 100 mVDC and then change output termination from 50 Ω to "high impedance," the offset voltage displayed on the front panel doubles to 200 mVDC (no error is generated). If you change from "high impedance" to 50 Ω, the displayed offset voltage will be halved. See **OUTPut[1|2]:LOAD** for details.
- Limits Due to Unit Selection: The amplitude limits are determined by the output units selected.
- You cannot specify output amplitude in dBm if output termination is set to high impedance. The units are automatically converted to Vpp.

## Commands and Queries

[SOURce[1|2]:]APPLy?

[SOURce[1|2]:]APPLy:ARBitrary [{<sample\_rate>|MIN|MAX|DEF} [, {<amplitude>|MIN|MAX|DEF} [, {<offset>|MIN|MAX|DEF}]]]

[SOURce[1|2]:]APPLy:DC

[SOURce[1|2]:]APPLy:NOISe

[SOURce[1|2]:]APPLy:PRBS

[SOURce[1|2]:]APPLy:PULSe

[SOURce[1|2]:]APPLy:RAMP

[SOURce[1|2]:]APPLy:SINusoid

[SOURce[1|2]:]APPLy:SQUare

[SOURce[1|2]:]APPLy:TRIangle

[SOURce[1|2]:]APPLy?

Queries the output configuration.

Parameter	Typical Return
(none)	"SIN +5.000000000000000E+03, +3.000000000000000E+00, -2.500000000000000E+00"
Return the configuration for a 5 kHz, 3 V sine wave with a -2.5 VDC offset. APPLY?	

- The function, frequency, amplitude, and offset are returned as shown above. The amplitude, but not the offset, is returned as specified by **VOLTage:UNIT**.

[SOURce[1|2]:]APPLY:ARbitrary [{<sample\_rate>|MIN|MAX|DEF} [, {<amplitude>|MIN|MAX|DEF} [, {<offset>|MIN|MAX|DEF}]]]

Outputs arbitrary waveform selected by FUNCTION: ARbitrary, using the specified sample rate, amplitude, and offset.

Parameter	Typical Return
<sample_rate> from 1 $\mu$ Sa/s to 250 MSa/s (33500 Series) or 1 GSa/s (33600 Series), default 40 kSa/s	(none)
<amplitude> from 1 mVpp to 10 Vpp into 50 $\Omega$ , 2 mVpp to 20 Vpp into an open circuit, default 100 mVpp into 50 $\Omega$	
<offset> is the DC offset voltage (default 0), from $\pm 5$ VDC into 50 $\Omega$ , or from $\pm 10$ VDC into an open circuit.	
Output the arbitrary waveform selected using FUNCTION:ARbitrary: APPLY:ARbitrary 1 kHz, 5.0, -2.5 V	

### General

- Setting a sample rate when not in the ARB mode will not change the frequency. For example, if the current function is sine, setting sample rate has no effect until the function changes to ARB.
- High sample rates may affect the actual amplitude due to filter roll-off.

### Options

- See FUNCTION: ARbitrary for available arbitrary waveform options. With FUNCTION:ARbitrary, you may select a built-in arbitrary waveform or the waveform currently downloaded to volatile memory using **MMEMory** commands.

### Offset Voltage

- The relationship between offset voltage and output amplitude is shown below.  $V_{max}$  is the maximum peak voltage for the selected output termination (5 V for a 50  $\Omega$  load or 10 V for a high-impedance load).

$$|V_{offset}| < V_{max} - V_{pp}/2$$

If the specified offset voltage is not valid, the instrument will adjust it to the maximum DC voltage allowed with the specified amplitude. From the remote interface, a "Data out of range" error will also be generated.

- Limits Due to Output Termination: The offset range depends on the output termination setting. For example, if you set offset to 100 mVDC and then change output termination from 50  $\Omega$  to "high impedance," the offset voltage displayed on the front panel doubles to 200 mVDC (no error is generated). If you change from "high impedance" to 50  $\Omega$ , the displayed offset voltage will be halved. See **OUTPut[1|2]:LOAD** for details.

[SOURce[1|2]:]APPLY:DC [{<frequency>|MIN|MAX|DEF} [, {<amplitude>|MIN|MAX|DEF} [, {<offset>|MIN|MAX|DEF}]]]

Outputs a DC voltage.

Parameter	Typical Return
<frequency> not applicable to DC function. Must be specified as a placeholder; the value is remembered when you change to a different function.	(none)
<amplitude> not applicable to DC function. Must be specified as a placeholder; the value is remembered when you change to a different function.	
<offset> is the DC offset voltage (default 0), from $\pm 5$ VDC into 50 $\Omega$ , or from $\pm 10$ VDC into an open circuit.	
Output a DC voltage of -2.5 V: APPLY:DC DEF, DEF, -2.5 V	

- Limits Due to Output Termination: The offset range depends on the output termination setting. For example, if you set offset to 100 mVDC and then change output termination from 50  $\Omega$  to "high impedance," the offset voltage displayed on the front panel doubles to 200 mVDC (no error is generated). If you change from "high impedance" to 50  $\Omega$ , the displayed offset voltage will be halved. See [OUTPut\[1|2\]:LOAD](#) for details. Changing the output termination setting does not change the voltage present at the output terminals of the instrument. This only changes the displayed values on the front panel and the values queried from the remote interface. The voltage present at the instrument's output depends on the load connected to the instrument. See [OUTPut\[1|2\]:LOAD](#) for details.



[SOURCE[1|2]:]APPLY:NOISE [{<frequency>|MIN|MAX|DEF} [, {<amplitude>|MIN|MAX|DEF} [, {<offset>|MIN|MAX|DEF}]]]

Outputs gaussian noise with the specified amplitude and DC offset.

Parameter	Typical Return
<frequency> not applicable to noise function. Must be specified as a placeholder; the value is remembered when you change to a different function.	(none)
<amplitude> Desired output amplitude in Vpp, Vrms or dBm, as specified by <b>VOLTage:UNIT</b> . 1 mVpp to 10 Vpp into 50 Ω, or twice that into an open circuit.  If specified in Vpp, the peak to peak output will actually be output very rarely, due to gaussian nature of noise.	
<offset> is the DC offset voltage (default 0), from ±5 VDC into 50 Ω, or from ±10 VDC into an open circuit.	
Output gaussian noise bounded by 3 Vpp, with -2.5 V offset: APPL:NOIS 5 KHZ, 3.0 V, -2.5 V	

### Frequency

- If you specify a frequency, it has no effect on the noise output, but the value is remembered when you change to a different function.
- For information on changing noise bandwidth, see FUNCTION:NOISE:BANDwidth.

### Offset Voltage

- The relationship between offset voltage and output amplitude is shown below. Vmax is the maximum peak voltage for the selected output termination (5 V for a 50 Ω load or 10 V for a high-impedance load).

$$|V_{\text{offset}}| < V_{\text{max}} - V_{\text{pp}}/2$$

If the specified offset voltage is not valid, the instrument will adjust it to the maximum DC voltage allowed with the specified amplitude.

From the remote interface, a "Data out of range" error will also be generated.

- Limits Due to Output Termination: The offset range depends on the output termination setting. For example, if you set offset to 100 mVDC and then change output termination from 50 Ω to "high impedance," the offset voltage displayed on the front panel doubles to 200 mVDC (no error is generated). If you change from "high impedance" to 50 Ω, the displayed offset voltage will be halved. See **OUTPUT[1|2]:LOAD** for details.

[SOURCE[1|2]:]APPLY:PRBS [{<frequency>|MIN|MAX|DEF} [, {<amplitude>|MIN|MAX|DEF} [, {<offset>|MIN|MAX|DEF}]]]

Outputs a pseudo-random binary sequence with the specified bit rate, amplitude and DC offset.

The default waveform is a PN7 Maximum Length Shift Register generator.

Parameter	Typical Return
<frequency> in bits/s, default 1000	(none)
<amplitude> Desired output amplitude in Vpp, Vrms or dBm, as specified by <b>VOLTage:UNIT</b> . 1 mVpp to 10 Vpp into 50 Ω, or twice that into an open circuit. Default is 100 mVpp into 50 Ω.	
<offset> is the DC offset voltage (default 0), from ±5 VDC into 50 Ω, or from ±10 VDC into an open circuit.	
Output pseudo-random bit sequence bounded by 3 Vpp, with -2.5 V offset: APPL:PRBS 5 KHZ, 3.0 V, -2.5 V	

### Frequency

- PRBS is generated by a Maximum Length Sequence (MLS) generator (Linear Feedback Shift Register) which may be configured to several standard configurations. Default is PN7 at 1000 bits/second.
- A PRBS waveform using polynomial PN<sub>x</sub> is generated by a shift register of *x* bits, and the output waveform begins with *x* sample periods of high output. Sample period is the reciprocal of the sample rate (**FUNCTION:PRBS:BRATe**), and the channel's **Sync** pulse indicates the waveform's start. For example, if the PRBS uses PN23 with sample rate 500 Hz, the output begins with 46 ms of high output (23 x 2 ms).
- Unlike the APPLY:NOISe function, the APPLY:PRBS function operates with the **Sync** output enabled. The **Sync** function indicates the beginning of the Pseudo-random function sequence.

### Offset Voltage

- The relationship between offset voltage and output amplitude is shown below. V<sub>max</sub> is the maximum peak voltage for the selected output termination (5 V for a 50 Ω load or 10 V for a high-impedance load).

$$|V_{\text{offset}}| < V_{\text{max}} - V_{\text{pp}}/2$$

If the specified offset voltage is not valid, the instrument will adjust it to the maximum DC voltage allowed with the specified amplitude. From the remote interface, a "Data out of range" error will also be generated.

- Limits Due to Output Termination: The offset range depends on the output termination setting. For example, if you set offset to 100 mVDC and then change output termination from 50 Ω to "high impedance," the offset voltage displayed on the front panel doubles to 200 mVDC (no error is generated). If you change from "high impedance" to 50 Ω, the displayed offset voltage will be halved. See **OUTPUT[1|2]:LOAD** for details.

[SOURce[1|2]:]APPLY:PULSe [{<frequency>|MIN|MAX|DEF} [, {<amplitude>|MIN|MAX|DEF} [, {<offset>|MIN|MAX|DEF}]]]

Outputs a pulse wave with the specified frequency, amplitude, and DC offset. In addition, **APPLY** performs the following operations:

- Preserves either the current pulse width setting (FUNCTION:PULSe:WIDTh) or the current pulse duty cycle setting (FUNCTION:PULSe:DCYCLe).
- Preserves the current transition time setting (FUNCTION:PULSe:TRANSition[:BOTH]).
- May cause instrument to override the pulse width or edge time setting to comply with the specified frequency or period (FUNCTION:PULSe:PERiod).

Parameter	Typical Return
<frequency> in Hz, default 1 kHz	(none)
<amplitude> Desired output amplitude in Vpp, Vrms or dBm, as specified by <b>VOLTage:UNIT</b> . 1 mVpp to 10 Vpp into 50 Ω, or twice that into an open circuit. Default is 100 mVpp into 50 Ω.	
<offset> is the DC offset voltage (default 0), from ±5 VDC into 50 Ω, or from ±10 VDC into an open circuit.	
Output a 5 Vpp pulse wave at 1 kHz with a -2.5 V offset: APPL:PULS 1 kHz, 5.0 V, -2.5 V	

### Frequency

- The APPLy command must be appropriate for the function. For example, APPL:PULS 300 MHz results in a "Data out of range" error. In that case, the frequency would be set to the instrument's **maximum frequency for a pulse**.

### Offset Voltage

- The relationship between offset voltage and output amplitude is shown below. Vmax is the maximum peak voltage for the selected output termination (5 V for a 50 Ω load or 10 V for a high-impedance load).

$$|\text{Voffset}| < V_{\text{max}} - V_{\text{pp}}/2$$

If the specified offset voltage is not valid, the instrument will adjust it to the maximum DC voltage allowed with the specified amplitude. From the remote interface, a "Data out of range" error will also be generated.

- Limits Due to Output Termination: The offset range depends on the output termination setting. For example, if you set offset to 100 mVDC and then change output termination from 50 Ω to "high impedance," the offset voltage displayed on the front panel doubles to 200 mVDC (no error is generated). If you change from "high impedance" to 50 Ω, the displayed offset voltage will be halved. See **OUTPut[1|2]:LOAD** for details.

[SOURce[1|2]:]APPLY:RAMP [{<frequency>|MIN|MAX|DEF} [, {<amplitude>|MIN|MAX|DEF} [, {<offset>|MIN|MAX|DEF}]]]

[SOURce[1|2]:]APPLY:TRiangle [{<frequency>|MIN|MAX|DEF} [, {<amplitude>|MIN|MAX|DEF} [, {<offset>|MIN|MAX|DEF}]]]

Outputs a ramp wave or triangle wave with the specified frequency, amplitude, and DC offset. In addition, **APPLY** performs the following operations:

- APPLY:RAMP overrides the current symmetry setting (**FUNCTION:RAMP:SYMMetry**), and sets 100% symmetry for the ramp waveform.
- APPLY:TRiangle is simply a special case of APPLY:RAMP. It is equivalent to a ramp waveform with 50% symmetry.

Parameter	Typical Return
<frequency> in Hz, default 1 kHz	(none)
<amplitude> Desired output amplitude in Vpp, Vrms or dBm, as specified by <b>VOLTage:UNIT</b> . 1 mVpp to <b>maximum allowed for the instrument model and waveform</b> into 50 Ω, or twice that into an open circuit. Default is 100 mVpp into 50 Ω.	
<offset> is the DC offset voltage (default 0), from ±5 VDC into 50 Ω, or from ±10 VDC into an open circuit.	
Configure a 5 V ramp wave at 3 kHz with 0 V offset: APPL:RAMP 3 KHZ, 5.0 V, 0	

### Frequency

- The APPLY command must be appropriate for the function. For example, the command APPL:RAMP 5 MHz results in a "Data out of range" error. In that case, the frequency would be set to 200 kHz, which is the maximum for a ramp.

### Offset Voltage

- The relationship between offset voltage and output amplitude is shown below. Vmax is the maximum peak voltage for the selected output termination (5 V for a 50 Ω load or 10 V for a high-impedance load).

$$|\text{Voffset}| < V_{\text{max}} - V_{\text{pp}}/2$$

If the specified offset voltage is not valid, the instrument will adjust it to the maximum DC voltage allowed with the specified amplitude. From the remote interface, a "Data out of range" error will also be generated.

- Limits Due to Output Termination: The offset range depends on the output termination setting. For example, if you set offset to 100 mVDC and then change output termination from 50 Ω to "high impedance," the offset voltage displayed on the front panel doubles to 200 mVDC (no error is generated). If you change from "high impedance" to 50 Ω, the displayed offset voltage will be halved. See **OUTPut[1|2]:LOAD** for details.

**[SOURce[1|2]:]APPLY:SINusoid** [{<frequency>|MIN|MAX|DEF} [, {<amplitude>|MIN|MAX|DEF} [, {<offset>|MIN|MAX|DEF}]]]

Outputs a sine wave with the specified frequency, amplitude, and DC offset.

Parameter	Typical Return
<frequency> from 1 μHz to instrument's <b>maximum frequency</b> . Default 1 kHz.	(none)
<amplitude> Desired output amplitude in Vpp, Vrms or dBm, as specified by <b>VOLTage:UNIT</b> . 1 mVpp to <b>maximum allowed for the instrument model and waveform</b> into 50 Ω, or twice that into an open circuit. Default is 100 mVpp into 50 Ω.	
<offset> is the DC offset voltage (default 0), from ±5 VDC into 50 Ω, or from ±10 VDC into an open circuit.	
Output 3 Vpp sine wave at 5 kHz with -2.5 V offset. APPL:SIN 5 KHZ, 3.0 VPP, -2.5 V	

### Offset Voltage

- The relationship between offset voltage and output amplitude is shown below. Vmax is the maximum peak voltage for the selected output termination (5 V for a 50 Ω load or 10 V for a high-impedance load).

$$|\text{Voffset}| < V_{\text{max}} - V_{\text{pp}}/2$$

If the specified offset voltage is not valid, the instrument will adjust it to the maximum DC voltage allowed with the specified amplitude. From the remote interface, a "Data out of range" error will also be generated.

- Limits Due to Output Termination: The offset range depends on the output termination setting. For example, if you set offset to 100 mVDC and then change output termination from 50 Ω to "high impedance," the offset voltage displayed on the front panel doubles to 200 mVDC (no error is generated). If you change from "high impedance" to 50 Ω, the displayed offset voltage will be halved. See **OUTPut[1|2]:LOAD** for details.

[SOURce[1|2]:]APPLy:SQUare [{<frequency>|MIN|MAX|DEF} [, {<amplitude>|MIN|MAX|DEF} [, {<offset>|MIN|MAX|DEF}]]]

Outputs a square wave with the specified frequency, amplitude, and DC offset. In addition, APPLy:SQUare overrides the current duty cycle setting (FUNction:SQUare:DCYCLE), and sets a 50% duty cycle for the square wave.

Parameter	Typical Return
<frequency> from 1 μHz to instrument's <b>maximum frequency</b> . Default 1 kHz.	(none)
<amplitude> Desired output amplitude in Vpp, Vrms or dBm, as specified by <b>VOLTage:UNIT</b> . 1 mVpp to <b>maximum allowed for the instrument model and waveform</b> into 50 Ω, or twice that into an open circuit. Default is 100 mVpp into 50 Ω.	
<offset> is the DC offset voltage (default 0), from ±5 VDC into 50 Ω, or from ±10 VDC into an open circuit.	
Output 3 V square wave at 5 kHz with -2.5 V offset: APPL:SQU 5 KHZ, 3.0 V, -2.5 V	

### Frequency

- The APPLy command must be appropriate for the function. For example, APPL:SQU 40 MHz results in a "Data out of range" error and the instrument sets the frequency to its **maximum frequency for a square wave**.

### Offset Voltage

- The relationship between offset voltage and output amplitude is shown below. Vmax is the maximum peak voltage for the selected output termination (5 V for a 50 Ω load or 10 V for a high-impedance load).

$$|V_{\text{offset}}| < V_{\text{max}} - V_{\text{pp}}/2$$

If the specified offset voltage is not valid, the instrument will adjust it to the maximum DC voltage allowed with the specified amplitude. From the remote interface, a "Data out of range" error will also be generated.

- Limits Due to Output Termination: The offset range depends on the output termination setting. For example, if you set offset to 100 mVDC and then change output termination from 50 Ω to "high impedance," the offset voltage displayed on the front panel doubles to 200 mVDC (no error is generated). If you change from "high impedance" to 50 Ω, the displayed offset voltage will be halved. See **OUTPut[1|2]:LOAD** for details.

## BPSK Subsystem

The BPSK subsystem allows you to modulate a waveform with Binary Phase Shift Keying (BPSK), a digital modulation format. In BPSK, the carrier waveform is phase shifted between two phase settings using an on/off keying. The source may be internal, using a square wave at a specified frequency, or external, using the external trigger input.

If the carrier function is an arbitrary waveform, then the phase shift only affects the position of sample transitions. This is different than shifting the phase of the overall arbitrary waveform.

### Example

To generate a BPSK waveform:

1. **Configure carrier waveform:** Use **FUNCTION**, **FREQUENCY**, **VOLTage**, and **VOLTage:OFFSet** to specify the carrier waveform's function, frequency, amplitude, and offset.
2. **Select modulation source (internal, external, CH1, or CH2):** **BPSK:SOURce**. For an external source, skip steps 3 and 4 below.
3. **Select BPSK phase:** **BPSK[:PHASe]**
4. **Set BPSK rate:** **BPSK:INTernal:RATE**
5. **Enable BPSK Modulation:** **BPSK:STATe ON**

The following code produces the oscilloscope image shown below.

```
FUNCTION SQU
FREQUENCY +1.0E+04
VOLTage +1.0
VOLTage:OFFset 0.0
BPSK:SOURce INT
BPSK:INTernal:RATE +3000
BPSK:PHASe +90
BPSK:STATe 1
OUTPut1 1
```

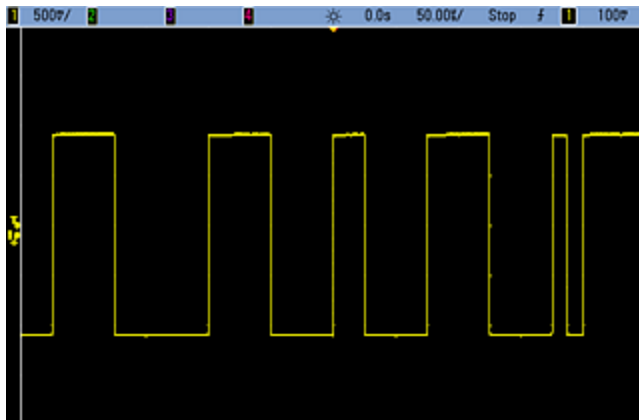

[SOURce[1|2]:]BPSK:INTernal:RATE {<modulating\_frequency>|MINimum|MAXimum|DEFault}  
[SOURce[1|2]:]BPSK:INTernal:RATE? [{MINimum|MAXimum}]

Sets the rate at which the output phase "shifts" between the carrier and offset phase.

Parameter	Typical Return
1 mHZ to 1 MHz, default 10 Hz	+1.0000000000000000E-03
Set BPSK rate to 1 mHz: BPSK:INT:RATE MIN	

- The BPSK rate is used *only* when the *INTernal* source is selected (**BPSK:SOURce INTernal**) and is ignored when the *EXTernal* source is selected (**BPSK:SOURce EXTernal**).
- The internal modulating waveform is a square wave with a 50% duty cycle.

[SOURce[1|2]:]BPSK[:]PHASe {<angle>|MINimum|MAXimum|DEFault}  
[SOURce[1|2]:]BPSK[:]PHASe? [{MINimum|MAXimum}]

Sets the Binary Phase Shift Keying phase shift in degrees.

Parameter	Typical Return
0 to +360 degrees, default 180	+1.8000000000000000E+02
Set phase shift to 90 degrees: BPSK:PHAS 90	



[SOURce[1|2]:]AM:SOURce {INTernal|EXTernal|CH1|CH2}  
[SOURce[1|2]:]AM:SOURce?

[SOURce[1|2]:]BPSK:SOURce {INTernal|EXTernal}  
[SOURce[1|2]:]BPSK:SOURce?

[SOURce[1|2]:]FM:SOURce {INTernal|EXTernal|CH1|CH2}  
[SOURce[1|2]:]FM:SOURce?

[SOURce[1|2]:]FSKey:SOURce {INTernal|EXTernal}  
[SOURce[1|2]:]FSKey:SOURce?

[SOURce[1|2]:]PM:SOURce {INTernal|EXTernal|CH1|CH2}  
[SOURce[1|2]:]PM:SOURce?

[SOURce[1|2]:]PWM:SOURce {INTernal|EXTernal|CH1|CH2}  
[SOURce[1|2]:]PWM:SOURce?

Selects the source of the modulating signal.

Parameter	Typical Return
{INTernal EXTernal CH1 CH2}, default INTernal. BPSK and FSKey cannot accept CH1 or CH2	INT, EXT, CH1, or CH2
Select external modulation source: AM:SOUR EXT (could also substitute FM, BPSK, FSK, PM, or PWM for AM)	

- If you select EXTERNAL, the carrier waveform is modulated with an external waveform. Specifically:
  - **AM:** The modulation depth is controlled by the  $\pm 5$  V signal level (or the optional  $\pm 1$  V signal level on the 33600 Series) on the rear-panel **Modulation In** connector. For example, if modulation depth (**AM[:DEPTH]**) is 100%, then when the modulating signal is at +5 V (or optionally +1 V on the 33600 Series), the output will be at the maximum amplitude. Similarly, a -5 V modulating signal (or optionally -1 V on the 33600 Series) produces output at minimum amplitude.
  - **FM:** If you select the *External* modulating source, the deviation is controlled by the  $\pm 5$  V signal level (optionally  $\pm 1$  V on the 33600 Series) on the rear-panel **Modulation In** connector. For example, if the frequency deviation is 100 kHz, then a +5 V signal level (optionally +1 V on the 33600 Series) corresponds to a 100 kHz increase in frequency. Lower external signal levels produce less deviation and negative signal levels reduce the frequency below the carrier frequency.
  - **PM:** With the External modulating source, deviation is controlled by the  $\pm 5$  V signal level (optionally  $\pm 1$  V on the 33600 Series) on the rear-panel **Modulation In** connector. For example, if you have set the frequency deviation to 180 degrees, then a +5 V signal level (optionally  $\pm 1$  V on the 33600 Series) corresponds to a +180 degree phase deviation. Lower external signal levels produce less deviation, and negative signal levels produce negative deviation.
  - **Pulse as Selected Function:** The pulse width or pulse duty cycle deviation is controlled by the  $\pm 5$  V signal level (optionally  $\pm 1$  V on the 33600 Series) present on the rear-panel **Modulation In** connector. For example, if you have set the pulse width deviation to 50  $\mu$ s using the **PWM:DEVIation** command, then a +5 V signal level (optionally +1 V on the 33600 Series) corresponds to a 50  $\mu$ s width increase. Lower external signal levels produce less deviation.
- With EXTERNAL source, the output phase (BPSK) or frequency (FSK) is determined by the signal level on the rear-panel **Ext Trig** connector. When a logic low is present, the carrier phase or carrier frequency is output. When a logic high is present, the phase shifted phase or hop frequency is output.
- The maximum external BPSK rate is 1 MHz, and the maximum FSK rate is 1 MHz.
- **Note:** the connector used for externally-controlled BPSK or FSK waveforms (**Trig In**) is not the same connector that is used for externally-modulated AM, FM, PM, and PWM waveforms (**Modulation In**). When used for BPSK or FSK, the **Trig In** connector does not have adjustable edge polarity and is not affected by the **TRIGger[1|2]:SLOPe** command.
- With INTERNAL source, the rate at which output phase (BPSK) or frequency (FSKey) "shifts" between the carrier phase or frequency and the alternate phase or frequency is determined by the BPSK rate (**BPSK:INTERNAL:RATE**) or FSK rate (**FSKey:INTERNAL:RATE**).
- A channel may not be its own modulation source.

## See Also

**INPut:ATTenuation[:STATe]**

**AM Subsystem**

**BPSK Subsystem**

**FM Subsystem**

**FSKey Subsystem**

**PM Subsystem**

**PWM Subsystem**

[SOURce[1|2]:]AM:STATe {ON|1|OFF|0}  
[SOURce[1|2]:]AM:STATe?

[SOURce[1|2]:]BPSK:STATe {ON|1|OFF|0}  
[SOURce[1|2]:]BPSK:STATe?

[SOURce[1|2]:]FM:STATe {ON|1|OFF|0}  
[SOURce[1|2]:]FM:STATe?

[SOURce[1|2]:]FSKey:STATe {ON|1|OFF|0}  
[SOURce[1|2]:]FSKey:STATe?

[SOURce[1|2]:]PM:STATe {ON|1|OFF|0}  
[SOURce[1|2]:]PM:STATe?

[SOURce[1|2]:]PWM:STATe {ON|1|OFF|0}  
[SOURce[1|2]:]PWM:STATe?

Enables or disables modulation.

Parameter	Typical Return
{ON 1 OFF 0}, default OFF	0 (OFF) or 1 (ON)
Enable AM (could also substitute FM, BPSK, FSK, PM, or PWM): AM:STAT ON	

- To avoid multiple waveform changes, enable modulation after configuring the other modulation parameters.
- Only one modulation mode may be enabled at a time.
- The instrument will not enable modulation with sweep or burst enabled. When you enable modulation, the sweep or burst mode is turned off.
- PWM is allowed only when pulse is the selected function.

#### See Also

[AM Subsystem](#)  
[PSK Subsystem](#)  
[FM Subsystem](#)  
[FSKey Subsystem](#)  
[PM Subsystem](#)  
[PWM Subsystem](#)

## BURSt Subsystem

This section describes the BURSt subsystem.

### Example

This summarizes the steps required to generate a burst.

1. **Configure the burst waveform:** Use **APPLY** or the equivalent **FUNCTION**, **FREQUENCY**, **VOLTage**, and **VOLTage:OFFSet** commands to select the waveform's function, frequency, amplitude, and offset. You can select a sine, square, triangle, ramp, pulse, PRBS, or arbitrary waveform (noise is allowed only in the gated burst mode and DC is not allowed). For internally-triggered bursts, the minimum frequency is 2.001 MHz. For sine and square waveforms, frequencies above 6 MHz are allowed only with an "infinite" burst count.
2. **Select the "triggered" or "gated" burst mode:** Select the triggered burst mode (called "N Cycle" on the front panel) or external gated burst mode using **BURSt:MODE**. If you are using gated mode, specify true-high or true-low logic with **BURSt:GATE:POLarity**.
3. **Set the burst count:** Set the burst count (number of cycles per burst) to any value between 1 and 100,000,000 cycles (or infinite) using the **BURSt:NCYCles** command. Used in the triggered burst mode only. In PRBS, **BURSt:NCYCles** sets the number of bits of PRBS. Each burst starts at the sequence start.
4. **Set the burst period:** Set the burst period (the interval at which internally-triggered bursts are generated) to any value from 1  $\mu$ s to 8000 seconds using **BURSt:INTernal:PERiod**. Used only in the triggered burst mode with an internal trigger source.
5. **Set the burst starting phase:** Set the starting phase of the burst from -360 to +360 degrees using **BURSt:PHASe**.
6. **Select the trigger source:** Select the trigger source using the **TRIGger[1|2]:SOURce** command. Used in the triggered burst mode only.
7. **Enable the burst mode:** After configuring the other burst parameters, enable burst mode (**BURSt:STATe ON**).

The following code produces the oscilloscope image shown below.

```
APPLY:SIN 1e5,3 VPP,0  
BURS:MODE TRIG  
BURS:NCYC 3  
BURS:INT:PER 4.4e-5  
BURS:PHAS 0  
TRIG:SOUR IMM  
BURS:STAT ON  
OUTP 1
```

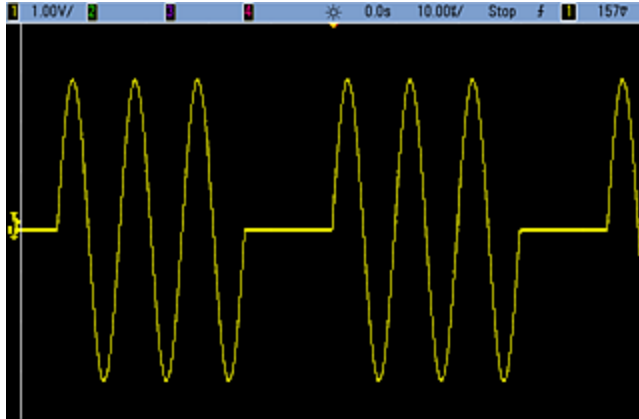

## Burst Modes

There are two burst modes, described below. The instrument enables one burst mode at a time.

- **Triggered Burst Mode (default):** The instrument outputs a waveform for a number of cycles (burst count) each time a trigger is received. After outputting the specified number of cycles, the instrument stops and waits for the next trigger. You can configure the instrument to use an internal trigger to initiate the burst or you can provide an external trigger by pressing the front panel **[Trigger]** key, by applying a trigger signal to the rear-panel **Ext Trig** connector, or by sending a software trigger command from the remote interface.
- **External Gated Burst Mode:** The instrument output is either "on" or "off" based on the level of the external signal applied to the rear-panel **Ext Trig** connector. When this signal is true, the instrument outputs a continuous waveform. When this signal goes false, the current waveform cycle is completed and then the instrument stops while remaining at the voltage corresponding to the starting burst phase of the waveform.

The following table shows which modes are associated with which burst features.

	<b>Burst Mode</b> BURSt:MODE	<b>Burst Count</b> BURSt:NCYCLe- s	<b>Burst Period</b> BURSt:INTernal:PERIo- d	<b>Burst Phase</b> BURSt:PHASe	<b>Trigger Source</b> TRIGger [1 2]:SOURce
<b>Triggered Burst Mode:</b> Internal Trigger	TRIGgered	Available	Available	Available	IMMediate
<b>Triggered Burst Mode:</b> External Trigger	TRIGgered	Available	Not Used	Available	EXTernal, BUS
<b>Gated Burst Mode:</b> External Trigger	GATed	Not Used	Not Used	Available	Not Used

The difference between gated burst and gated output is that gated burst synchronously starts and stops using full waveform cycles, where gated output asynchronously turns instrument output on or off with an external trigger, independent of the waveform phase.

### NOTE

If the duty cycle is changed on a triggered burst square wave with the trigger mode set to Timer, the current burst will finish and one more burst will be executed before the duty cycle of the burst changes.

**[SOURCE[1|2]:]BURSt:GATE:POLarity {NORMal|INVerted}**  
**[SOURCE[1|2]:]BURSt:GATE:POLarity?**

Selects true-high (NORMal) or true-low (INVerted) logic levels on the rear-panel **Ext Trig** connector for an externally gated burst.

Parameter	Typical Return
{NORMal INVerted}, default NORMal	NORM or INV
Select true-low logic for an externally gated burst: BURS:GATE:POL INV	

**[SOURCE[1|2]:]BURSt:INTernal:PERiod {<seconds>|MINimum|MAXimum}**  
**[SOURCE[1|2]:]BURSt:INTernal:PERiod? [{MINimum|MAXimum}]**

Sets the burst period for internally-triggered bursts.

Parameter	Typical Return
1 $\mu$ s to 8000 s, default 10 ms	+1.2000000000000000E+01
Sets the burst period to 12 seconds: BURS:INT:PER 12	

- The burst period is the time between the starts of consecutive bursts.
- This is used only when IMMEDIATE triggering is enabled (TRIGger[1|2]:SOURce IMMEDIATE). It is ignored when manual or external triggering is enabled (or with gated burst mode).
- On the 33500 Series, burst period must satisfy the following formula:

$$\text{Burst Period} \geq (\text{Burst Count} / \text{Waveform Frequency}) + 1 \mu\text{s}.$$

On the 33600 Series, burst period must satisfy the following formula:

$$\text{Burst Period} \geq (\text{Burst Count} / \text{Waveform Frequency}) + 500 \text{ ns}, \text{ with a minimum Burst Period of } 1 \mu\text{s}.$$

- If the burst period is too short, the instrument will increase it as needed to continuously re-trigger the burst. From the remote interface, a "Settings conflict" error will also be generated.

[SOURce[1|2]:]BURSt:MODE {TRIGgered|GATed}  
[SOURce[1|2]:]BURSt:MODE?

Selects the burst mode.

Parameter	Typical Return
{TRIGgered GATed}, default TRIGgered	TRIG or GAT
Set gated burst mode BURS:MODE GATED	

- TRIGgered: the instrument outputs a waveform for a number of cycles (burst count) each time a trigger is received from the trigger source (TRIGger[1|2]:SOURce).
- In GATed burst mode, the output waveform is on or off, based on the signal at the rear-panel **Ext Trig** connector. Select this signal's polarity using BURSt:GATE:POLarity. When the gate signal is true, the instrument outputs a continuous waveform. When the gate signal goes false, the current waveform cycle is completed and the instrument stops and remains at the voltage level corresponding to the waveform's starting burst phase. For a noise waveform, the output stops immediately when the gate signal goes false.
- GATed: burst count, burst period, and trigger source are ignored (these are used for the triggered burst mode only). If a manual trigger is received (TRIGger[1|2]), it is ignored and no error will be generated.

[SOURce[1|2]:]BURSt:NCYCles {<num\_cycles>|INFinity|MINimum|MAXimum}  
[SOURce[1|2]:]BURSt:NCYCles? [{MINimum|MAXimum}]

Sets the number of cycles to be output per burst (triggered burst mode only).

Parameter	Typical Return
Whole number from 1 (default) to 100,000,000, limited as described below	+5.0000000000000000E+01
Return number of cycles per burst: BURS:NCYC 50	

- With TRIGger[1|2]:SOURce IMMEDIATE, burst count must be less than the product of the maximum burst period (8000 s) and the waveform frequency, as shown below.

$$\text{Burst Count} < (\text{Maximum Burst Period})(\text{Waveform Frequency})$$

- The increase the burst period up to its maximum value to accommodate the burst count (but the waveform frequency will not be changed). From the remote interface, a "Settings conflict" error will also be generated.
- When gated burst mode is selected, the burst count is ignored. However, if you change the burst count while in the gated mode, the instrument remembers the new count and used it when the triggered mode is selected.



[SOURce[1|2]:]BURSt:PHASe {<angle>|MINimum|MAXimum}  
[SOURce[1|2]:]BURSt:PHASe? [{MINimum|MAXimum}]

Sets the starting phase angle for the burst.

Parameter	Typical Return
-360 to +360 degrees, $-2\pi$ to $+2\pi$ radians, or -(period) to +(period), as specified by <b>UNIT:ANGLE</b> . Default 0.	+6.0000000000000E+01
Set starting burst phase to 60 degrees: UNIT:ANGLE DEG BURS:PHAS 60	

- Note that BURSt:PHASe is used instead of output phase, and when burst is enabled, the output phase is set to 0.
- For sine, square, and ramp, 0 degrees is the point at which the waveform crosses 0 V (or DC offset) in a positive-going direction. For arbitrary waveforms, 0 degrees is the first waveform point. Start phase has no effect on noise.
- For arbitrary waveforms on the 33500 Series, BURSt:PHASe is only available if the waveform is 1,000,000 points or less.
- Start phase also used in gated burst mode. When the gate signal goes false, the current waveform cycle finishes, and output remains at the voltage level of the starting burst phase.

[SOURce[1|2]:]BURSt:STATe {ON|1|OFF|0}  
[SOURce[1|2]:]BURSt:STATe?

Enables or disables burst mode.

Parameter	Typical Return
{ON 1 OFF 0}, default OFF	0 (OFF) or 1 (ON)
Enable burst mode: BURS:STAT ON	

- Output phase is set to 0 when burst is enabled.
- To avoid multiple waveform changes, enable the burst mode after configuring the other burst parameters.
- The instrument will not allow the burst mode to be enabled at the same time that sweep or any modulation mode is enabled. When you enable burst, the sweep or modulation mode is turned off.

## CALibration Subsystem

The CALibration subsystem is used to calibrate the instrument.

### Commands and Queries

CALibration[:ALL]?

CALibration:COUNT?

CALibration:SECure:CODE <new\_code>

CALibration:SECure:STATe {ON|1|OFF|0} [, <code>]

CALibration:SECure:STATe?

CALibration:SETup <step>

CALibration:SETup?

CALibration:STORE

CALibration:STRing "<string>"

CALibration:STRing?

CALibration:VALue <value>

CALibration:VALue?

### CALibration[:ALL]?

Performs a calibration using the calibration value (CALibration:VALue). The instrument must be unlocked (CALibration\_SECure\_STATe OFF, <code>) to calibrate.

Parameter	Typical Return
(none)	+0 (pass) or +1 (fail)
Calibrate using the current value: CAL?	

- CALibration:SETup should always precede the CALibration? query.
- Increments the instrument's calibration count (CALibration:COUNT?).
- Modifies the volatile version of the calibration constants. Use CALibration:STORE to save these constants in nonvolatile memory at end of calibration.

## CALibration:COUNT?

Returns the number of calibrations performed. Read and record the initial count when you receive your instrument from the factory.

Parameter	Typical Return
(none)	+117
Return the calibration count: CAL:COUN?	

- Because the value increments for each calibration point (each CALibration:ALL?), a complete calibration adds many counts.
- You can display count regardless of whether instrument is secured.
- This setting is non-volatile; it will not be changed by power cycling or \*RST.

## CALibration:SECure:CODE <new\_code>

Sets the security code to prevent unauthorized calibrations.

Parameter	Typical Return
Unquoted string up to 12 characters Must start with letter (A-Z) May contain letters, numbers (0-9) and underscores	(none)
Set new security code: CAL:SEC:CODE MY_CODE_272	

- The factory default security codes vary by model:

Models	Security Code
33521A and 33522A	AT33520A
335XXB	AT33500
33600 Series	AT33600

- To change code: unsecure calibration memory with the old code, and then set new code.
- If you forget the security code, see [Unsecure Instrument Without Security Code](#).
- This setting is non-volatile; it will not be changed by power cycling or \*RST.

**CALibration:SECure:STATe** {ON|1|OFF|0} [, <code>]

**CALibration:SECure:STATe?**

Unsecures or secures the instrument for calibration. To calibrate, you must unsecure the instrument with the code (**CALibration:SECure:CODE**).

Parameter	Typical Return
{ON 1 OFF 0}, default ON <code> is an unquoted string up to 12 characters	0 (OFF) or 1 (ON)
Unsecure calibration: CAL:SEC:STAT OFF,MY_CODE_272 Secure calibration: CAL:SEC:STAT ON	

- The <code> is optional to secure the instrument, but must be correct if provided.
- Front panel and remote interface calibration use same code. If you secure the instrument from one interface, use the same code to unsecure it from the other interface.
- This setting is non-volatile; it will not be changed by power cycling or \*RST.

**CALibration:SETup** <step>

**CALibration:SETup?**

Configures the calibration step (default 1) to be performed. The instrument must be unlocked (**CALibration\_SECure\_STATe OFF, <code>**) to calibrate. See **Calibration Security** for details.

Parameter	Typical Return
Whole number, default 1	+16
Prepare for calibration step 5: CAL:SET 5	

- This setting is non-volatile; it will not be changed by power cycling or \*RST.

**CALibration:STORe**

Takes calibration constants in volatile memory (**CALibration:ALL?**), and places them in nonvolatile memory, where they will not be changed by power cycle or \*RST. Do this at the end of calibration to avoid losing changes.

Parameter	Typical Return
(none)	(none)
Store calibration constants into non-volatile memory: CAL:STOR	

**CALibration:STRing "<string>"**  
**CALibration:STRing?**

Stores a message of up to 40 characters in calibration memory. Common messages include last calibration date, calibration due date, or contact information for calibration department. The instrument must be unlocked (**CALibration\_SEcure\_STATe OFF,<code>**) to store this string.

Parameter	Typical Return
Quoted string up to 40 characters May contain letters, numbers, spaces, and other common characters.	"LAST CAL OCT 31 2011, DUE OCT 31 2012" (If no string stored, returns "")
CAL:STR "FOR CAL HELP, CALL JOE AT EXT 1234"	

- May be stored only from remote interface, with instrument unsecured (**CALibration:SECure:STATe OFF**).
- You can read the message from the front panel or remote interface, regardless of whether the instrument is secured.
- Storing a calibration message overwrites the previous message.
- This setting is non-volatile; it will not be changed by power cycling or **\*RST**.

**CALibration:VALue <value>**  
**CALibration:VALue?**

Specifies the value of the known calibration signal.

Parameter	Typical Return
Numeric, default 0.0	+2.37000000E-002
Specify calibration value 0.0237: CAL:VAL 2.37E-2	

- This setting is non-volatile; it will not be changed by power cycling or **\*RST**.

[SOURce[1|2]:]COMBine:FEED {CH1|CH2|NONE}  
[SOURce[1|2]:]COMBine:FEED?

Enables or disables the combining of both channels' outputs on a two-channel instrument into a single channel connector. The "SOURce" keyword (default, SOURce1) specifies the base channel, and <source> specifies the channel to be combined with the base channel.

Parameter	Typical Return
{CH1 CH2 NONE}, default NONE	CH1, CH2, or NONE
Set the COMBine:FEED source for base Channel 1 to be Channel 2: COMB:FEED CH2	

- COMBine:FEED allows digital data from both channels to be added together to create the output signal on the output DAC for the base channel.
- Only one channel may operate in COMBine:FEED mode at a time
- Unlike the Modulation and SUM commands, COMBine:FEED can add two modulated signals.
- COMBine:FEED can generate quadrature modulated signals from the two channels to be added together into a single connector.
- To use COMBine:FEED, first configure all parameters on the individual channels.
- The signals to be combined may have a fixed phase offset between the channels.
- You can use COMBine:FEED to add noise from a second channel to a modulated signal on the base channel.
- If COMBine:FEED would cause the combined output to exceed either the instrument's output rating or the programmed limits, the instrument will set COMBine:FEED to NONE and report a settings conflict error.
- Signals are combined in digital form. When two signals of significantly different amplitudes are combined, the lower amplitude signal may have reduced resolution proportional to the ratio of the two amplitudes.
- Changing the function amplitude or sum amplitude of the master or combined channel will not change the amplitude or offset of any other function or channel. If changing the function amplitude or sum amplitude of the master or combined channel would result in exceeding either the output rating or the programmed limits, the amplitude value will be clipped and a settings conflict error will be reported.
- Changing the channel offset of the master or combined channel will not change the amplitude or offset of any other function or channel. If changing channel offset of the master or combined channel would result in exceeding either the output rating or the programmed limits, the amplitude value will be clipped and the instrument will report a settings conflict error.
- If turning limits on or adjusting programmed limits would result in a limit being lower than a signal maximum or higher than a signal minimum, the limits will not be turned on or adjusted, and the instrument will report a settings conflict error.

## DATA Subsystem

The DATA subsystem manages user-defined arbitrary waveforms:

- `[SOURCE[1|2]:]DATA:ARbitrary2:FORMat {AABB|ABAB}` - specifies the order for bytes in a dual arbitrary waveform file (requires optional IQ player).
- `[SOURCE[1|2]:]DATA:ARbitrary[1|2] <arb_name>, {<binary_block>|<value>, <value>, . . .}` - downloads arbitrary waveform normalized values to waveform memory
- `[SOURCE[1|2]:]DATA:ARbitrary[1|2]:DAC <arb_name>, {<binary_block>|<value>, <value>, . . .}` - downloads arbitrary waveform DAC codes to waveform memory
- `[SOURCE[1|2]:]DATA:ATTRibute:AVERage? [<arb_name>]` - returns arithmetic average of all data points for an arbitrary waveform or sequence
- `[SOURCE[1|2]:]DATA:ATTRibute:CFACtor? [<arb_name>]ATA:ATTRibute:CFACtor?` - returns crest factor of all data points in an arbitrary waveform or sequence
- `[SOURCE[1|2]:]DATA:ATTRibute:POINts? [<arb_name>]` - returns number of data points for arbitrary waveform or sequence
- `[SOURCE[1|2]:]DATA:ATTRibute:PTPeak? [<arb_name>]` - returns peak-to-peak value of all data points in an arbitrary waveform or sequence
- `[SOURCE[1|2]:]DATA:SEQUence <block_descriptor>` - combines previously loaded arbitrary waveforms into a sequence
- `[SOURCE[1|2]:]DATA:VOLatile:CATalog?` - returns the contents of volatile waveform memory, including arbitrary waveforms and sequences
- `[SOURCE[1|2]:]DATA:VOLatile:CLEar` - clears volatile waveform memory
- `[SOURCE[1|2]:]DATA:VOLatile:FREE?` - returns number of points available (free) in volatile memory

## Examples

The following example uses DATA commands to set up an arbitrary waveform sequence.

### NOTE

The DATA:SEQuence command shown below is an example of a definite-length block. The "#3" at the beginning indicates that the next three digits will indicate how many characters are in the block. The "164" immediately following indicates that there are 164 characters in the string that follows.

Note that the long DATA:SEQuence command splits across lines for readability purposes.

Note also that the quotation marks in the DATA:SEQuence command are optional.

```
*CLS
*RST

MMEM:LOAD:DATA "INT:\BUILTIN\HAVERSINE.arb"
MMEM:LOAD:DATA "INT:\BUILTIN\CARDIAC.arb"
MMEM:LOAD:DATA "INT:\BUILTIN\GAUSSIAN.arb"

DATA:SEQuence
#3164"testSeq", "INT:\BUILTIN\HAVERSINE.arb", 0, repeat, highAtStartGoLow, 30,
"INT:\BUILTIN\CARDIAC.arb", 0, repeat, maintain, 10,
"INT:\BUILTIN\GAUSSIAN.arb", 0, repeat, maintain, 10
FUNC:ARB "testSeq"

FUNC ARB
OUTPUT1 ON
```

This sequence runs the Haversine waveform 30 times and then runs the Cardiac and Gaussian waveforms 10 times each. The Haversine waveform forces the marker high at the start of each run and then sets it low at the marker point. The other two waveforms maintain the marker setting.



Format for <arb\_name>

Many DATA commands use the name of an arbitrary waveform. The following rules apply:

- <arb\_name> must match:
  - A waveform already loaded into waveform memory
  - A waveform existing in INTERNAL or USB mass memory
- See **MMEMory:LOAD:DATA[1|2]**, **DATA:ARbitrary**, or **DATA:ARbitrary:DAC** for valid formats for <arb\_name>.

**[SOURce[1|2]:]DATA:ARbitrary2:FORMat {AABB|ABAB}**

**(Applies only to instruments with the optional IQ player capability.)**

Specifies whether the format for data points in **DATA:ARB2** and **DATA:ARB2:DAC** commands is interleaved (ABAB) or all of channel 1 followed by all of channel 2 (AABB).

**NOTE**

You may spell out the keyword **ARbitrary2**, but you must abbreviate it as **ARB2**. You cannot abbreviate it as **ARB**.

Parameter	Typical Return
{AABB ABAB}	AABB or ABAB
Specify an interleaved data format for dual arbitrary waveform data: DATA:ARB2:FORM ABAB	

- The **SOURce** keyword is ignored for this command.
- If you wish to have a 3 DAC count signal on channel 1 and a 4 DAC count signal on channel 2, the **AABB** format would dictate that the data must be sent as 3, 3, 3, 3, 3, 3, 3, 3, 4, 4, 4, 4, 4, 4, 4. The **ABAB** format would dictate the order 3, 4, 3, 4, 3, 4, 3, 4, 3, 4, 3, 4, 3, 4.

[SOURce[1|2]:]DATA:ARbitrary[1|2] <arb\_name>, {<binary\_block>|<value>, <value>, ...}

[SOURce[1|2]:]DATA:ARbitrary[1|2]:DAC <arb\_name>, {<binary\_block>|<value>, <value>, ...}

Downloads integer values representing DAC codes (DATA:ARbitrary[1|2]:DAC) or floating point values (DATA:ARbitrary[1|2]) into waveform volatile memory as either a list of comma separated values or binary block of data. The DAC codes go from -32,768 to +32,767 on both the 33500 Series and 33600 Series.

**NOTE**

The optional [1|2] after the ARbitrary keyword indicates whether the data to be downloaded contains one (default) or two channels of data.

To use dual arbitrary waveform files (single files containing two channels of arbitrary waveform data), you must have the **optional IQ Player.**

Parameter	Typical Return
<arb_name> An unquoted string of up to 12 characters.	(none)
<binary_block> integer values from -32767 to +32767 or floating point values from -1.0 to +1.0 in Definite Length Arbitrary Block format (details below). From 8 to 1M or 16M samples per waveform, <b>depending on the model and options.</b>  Definite-length block data allows any type of device-dependent data to be transmitted as a series of 8-bit binary data bytes. This is particularly useful for transferring large quantities of data or 8-bit extended ASCII codes.	
<value> comma separated list of integer values from -32,767 to +32,767 or floating point values from -1.0 to +1.0. From 8 to 65,536 points.	

Parameter	Typical Return
Download a comma separated list of nine waveform points into waveform memory: DATA:ARB:DAC myArb, 32767, 24576, 16384, 8192, 0, -8192, -16384, -24576, -32767	
Download nine waveform points into waveform memory as a binary block. The <PMT> specifies what terminates the binary data. It can be a Line Feed character, or the last byte of <i>your_binary_data</i> can assert the End or Identify. DATA:ARB myArb, #236<36 bytes of your_binary_data><PMT>	
Download a comma separated list of nine waveform points into waveform memory: DATA:ARB myArb, 1, .75, .50, .25, 0, -.25, -.50, -.75, -1	
Download eight waveform points of a dual arbitrary waveform into waveform memory as a comma separated list of DAC codes. There are 16 values in all, eight for each of two channels. Note that the data is interleaved (ABAB), so the positive values are all on channel 1, and the negative values are all on channel 2: DATA:ARB2:FORM ABAB DATA:ARB2:DAC myArb, 30000, -10000, 29000, -9000, 27000, -7000, 24000, -4000, 27000, -7000, 29000, -9000, 30000, -10000, 29000, -9000	
Download the same examples as above, but in AABB format: DATA:ARB2:FORM AABB DATA:ARB2:DAC myArb, 30000, 29000, 27000, 24000, 27000, 29000, 30000, 29000, -10000, -9000, -7000, -4000, -7000, -9000, -10000, -9000	

- Each data point is either a 16-bit integer from -32,767 and +32,767 or a 32-bit floating point value from -1.0 to +1.0. Therefore, the total number of bytes is always two times or four times the number of data points in the waveform. For example, 16,000 bytes are required to download a waveform with 8,000 points as integers, but 32,000 bytes are required to download the same waveform as floating point values.
- The values -32767 and +32767 or -1.0 to +1.0 correspond to the peak values of the waveform (if the offset is 0 V). For example, if you set the output amplitude to 10 Vpp, +32767 corresponds to +5 V and -32767 corresponds to -5 V.
- Use **FORMat:BOReR** to select the byte order for block mode binary transfers.
- Use **DATA:ARB2:FORMat** to specify whether dual arbitrary waveforms are interleaved or sequential (channel 1 followed by channel 2).
- Specifying a waveform that is already loaded generates a "Specified arb waveform already exists" error. Deleting an existing waveform requires clearing all of the waveform memory with **DATA:VOLatile:CLEar**.
- The total available sample size for all waveforms loaded per channel is either 1 MSa or 16 MSa (33500 Series) or 4 MSa or 64 MSa (33600 Series), **depending on model and options**. A new waveform may be limited by waveforms already loaded.

**NOTE**

Regardless of what options may be installed, the maximum waveform size for the embedded waveform editor is 1 MSa.

### [SOURCE[1|2]:]DATA:ATTRibute:AVERage? [<arb\_name>]

Returns the arithmetic mean of all data points for the specified arbitrary waveform INTERNAL or USB memory, or loaded into waveform memory.

Parameter	Typical Return
<arb_name> is any valid file name. If omitted, the default <arb_name> is the arbitrary waveform currently active (selected with <b>FUNCTION:ARbitrary</b> ).	+2.47199927E-002
Return the mean of all points stored in "SINC". DATA:ATTR:AVER? "INT:\BuiltIn\SINC.arb"	

- Querying a waveform that does not exist generates a "Specified arb waveform does not exist" error.
- <arb\_name> can be a file name (put in memory by **MMEMory:LOAD:DATA[1|2]**) or a name generated from **DATA:ARbitrary** or **DATA:ARbitrary:DAC**.

### [SOURCE[1|2]:]DATA:ATTRibute:CFACtor? [<arb\_name>]

Returns the *crest factor* of all data points for the specified arbitrary waveform segment in INTERNAL or USB memory, or loaded into waveform memory.

Parameter	Typical Return
<arb_name> is any valid file name. If omitted, the default <arb_name> is the arbitrary waveform currently active (selected with <b>FUNCTION:ARbitrary</b> ).	+1.72513640E+000
Return crest factor of all data points stored in "NEG_RAMP". DATA:ATTR:CFAC? "INT:\BuiltIn\NEG_RAMP.arb"	

- Crest factor is the ratio of the peak value to the RMS value of the waveform.
- Querying a waveform that does not exist generates a "Specified arb waveform does not exist" error.
- <arb\_name> can be a file name (put in memory by **MMEMory:LOAD:DATA[1|2]**) or a name generated from **DATA:ARbitrary** or **DATA:ARbitrary:DAC**.

### [SOURce[1|2]:]DATA:ATTRibute:POINts? [<arb\_name>]

Returns the number of points in the specified arbitrary waveform segment in INTERNAL or USB memory, or loaded into waveform memory.

Parameter	Typical Return
<arb_name> is any valid file name. If omitted, the default <arb_name> is the arbitrary waveform currently active (selected with <b>FUNCtion:ARBitrary</b> ).	+250
Returns the number of data points in "EXP_RISE": DATA:ATTR:POIN? "INT:\BuiltIn\EXP_RISE.arb"	

- <arb\_name> can be a file name (put in memory by **MMEMory:LOAD:DATA[1|2]**) or a name generated from **DATA:ARBitrary** or **DATA:ARBitrary:DAC**.

### [SOURce[1|2]:]DATA:ATTRibute:PTPeak? [<arb\_name>]

Calculates the *peak-to-peak value* of all data points for the specified arbitrary waveform segment in INTERNAL or USB memory, or loaded into waveform memory.

Parameter	Typical Return
Any valid file name. If omitted, the default <arb_name> is the arbitrary waveform currently active (selected with <b>FUNCtion:ARBitrary</b> ).	+1.00000000E+000
Return the peak-to-peak value for "EXP_FALL": DATA:ATTR:PTP? "INT:\BuiltIn\EXP_FALL.arb"	

- <arb\_name> must match:
  - A waveform already loaded into waveform memory
  - A waveform existing in INTERNAL or USB mass memory
- See **MMEMory:LOAD:DATA[1|2]**, **DATA:ARBitrary**, or **DATA:ARBitrary:DAC** for valid formats for <arb\_name>.
- Arbitrary Waveform Limitations: For arbitrary waveforms, amplitude is limited if the waveform data points do not span the full range of the output DAC (Digital-to-Analog Converter). For example, the built-in "Sinc" waveform does not use the full range of values, so its maximum amplitude is limited to 6.087 Vpp (into 50 Ω).
- <arb\_name> can be a file name (put in memory by **MMEMory:LOAD:DATA[1|2]**) or a name generated from **DATA:ARBitrary** or **DATA:ARBitrary:DAC**.

## [SOURCE[1|2]:]DATA:SEQUence <block\_descriptor>

Defines a sequence of waveforms already loaded into waveform memory via **MMEMory:LOAD:DATA[1|2]** or **DATA:ARbitrary**. The **MMEMory:LOAD:DATA[1|2]** command can also load a sequence file that automatically loads the associated arbitrary waveforms and includes the amplitude, offset, sample rate, and filter setup.

Parameter	Typical Return
IEEE Definite Length Arbitrary Block, described below.	(none)
(see <a href="#">example</a> )	

- Even arbitrary waveforms with millions of points may be insufficient for applications requiring special sequencing or the repetition of waveforms dependent upon time or external events. Sequencing arbitrary waveforms allows you to arrange and conditionally repeat waveforms. This allows you to use less memory and to achieve greater application flexibility.

Definite-length block data allows any type of device-dependent data to be transmitted as a series of 8-bit binary data bytes. This is particularly useful for transferring large quantities of data or 8-bit extended ASCII codes.

- <block\_descriptor> is of the format #<n><n digits><sequence name>,<arb name1>,<repeat count1>,<play control1>,<marker mode1>,<marker point1>,<arb name2>,<repeat count2>,<play control2>,<marker mode2>,<marker point2>, and so on, where:
  - <n> specifies the number of digits used to indicate the size of the block.
  - <n digits> is one or more digits that specifies the number of data bytes to come.
  - <sequence name> is an optionally quoted string that specifies the name of sequence that contains the arbitrary waveforms specified in the following parameters.
  - <arb name> is an optionally quoted string that specifies the name of the arbitrary waveform that was loaded with the **MMEM:LOAD:DATA[1|2]** or **DATA:ARbitrary** commands.
  - <repeat count> is an optionally quoted string that specifies the number of times to repeat the waveform. This value can range from 1 to 1E6 or infinite. This will only be recognized in the hardware if Play Control is set to "repeat".
  - <play control> is an optionally quoted string that specifies how the arbitrary waveform is to be played in the sequence:
    - **once**- play once
    - **onceWaitTrig**- play once and then wait for trigger. Triggers will not be accepted until the play of the specified segment has completed.
    - **repeat**- repeat number of times specified by repeat count
    - **repeatInf**- repeat until stopped (infinite)

- **repeatTilTrig** - repeat until triggered then advance

**NOTE**

With small waveforms, it may take a few cycles after the trigger is received to switch to the next waveform. This is because the samples in the sample buffer must be cleared.

- *<marker mode>* is an optionally quoted string that specifies how the marker behaves in the arbitrary waveform:
  - **maintain**- maintain current marker state at start of segment
  - **lowAtStart**- force marker low at start of segment
  - **highAtStart**- force marker high at start of segment
  - **highAtStartGoLow**- force marker high at start of segment and then low at marker position
- *<marker point>* a number specifying the marker location in the arbitrary waveform. This value must be between 4 and the number of points in the arbitrary waveform minus 3.
- If you specify an arbitrary waveform that has not been loaded, a "Specified arb waveform does not exist" error is generated.

**Example of DATA:SEquence command**

The following command constructs a sequence (named mySequence) of three segments (A.arb, B.arb, and C.arb) that were previously loaded from the USB drive using **MMEMory:LOAD:DATA[1|2]**. The sequence plays A once, and B five times. It then plays C repeatedly while waiting for a trigger to advance, and finally ends with A. Each segment has the *<marker point>* set to 10.

The command is shown on multiple lines for readability purposes only.

```
DATA:SEQ
#3158"mySequence", "USB:\A.arb", 0, once, lowAtStart, 10, "USB:\B.arb", 5, repeat-
, highAtStart, 10,
"USB:\C.arb", 0, repeatTilTrig, maintain, 10, "USB:\A.arb", 0, once, lowAtStart, 1-
0
```

Many text editors let you count the number of bytes in the block simply by highlighting a text string. In this example, the size is 158, which requires 3 digits to represent – hence the #3158 header.

Using this approach requires you to pre-load all of the arbitrary waveforms and set the amplitude and offset (or high and low levels), sample rate, and filter. See **MMEM:LOAD:DATA** to combine all that information into a single file rather than creating a block transfer with multiple SCPI commands.

### [SOURCE[1|2]:]DATA:VOLatile:CATalog?

Returns the contents of volatile waveform memory, including arbitrary waveforms and sequences.

Parameter	Typical Return
(none)	"INT:\BUILTIN\EXP_RISE.ARB","USB:\XYZ\A.ARB","USB:\XYZ\B.ARB","USB:\xyz\xyz.seq"
Return the contents of volatile waveform memory assuming waveforms A.arb, B.arb, and C.arb were previously loaded on channel 1 via a sequence file on USB:\xyz\xyz.seq: DATA:VOL:CAT?	

### [SOURCE[1|2]:]DATA:VOLatile:CLEar

Clears waveform memory for the specified channel and reloads the default waveform.

Parameter	Typical Return
(none)	(none)
Clear contents of waveform memory on channel 1 and reload default waveform: DATA:VOL:CLE	

### [SOURCE[1|2]:]DATA:VOLatile:FREE?

Returns number of points available (free) in volatile memory. Each arbitrary waveform loaded into volatile memory consumes space allocated in 128-point blocks, so a waveform of 8 to 128 points consumes one such block, a waveform of 129 to 256 points consumes two blocks, and so on.

The standard instrument includes memory for 1 million points per channel (33500 Series) or 4 million points per channel (33600 Series). You may also **extend the size of the memory up to 16M (33500 Series) or 64M points (33600 Series)**.

Parameter	Typical Return
(none)	+382956
Return number of bytes of free volatile memory: DATA:VOL:FREE?	



## DISPlay Subsystem

The DISPlay subsystem controls the instrument's display.

### Example

The following program turns off the instrument's display and then shows a message that indicates people should not touch the instrument.

```
DISP OFF
DISP:TEXT "Test running. Please do not touch."
```

### Commands

The DISPlay subsystem includes the following commands.

- **DISPlay {ON|1|OFF|0}** - enables or disables display
- **DISPlay:FOCUS** - selects the channel displayed "in front" on a two-channel instrument
- **DISPlay:TEXT "<string>"** - displays text message on display
- **DISPlay:TEXT:CLEAr** - clears text messages from display
- **DISPlay:UNIT:ARBRate {SRATe|FREQuency|PERiod}** - selects the arbitrary waveform rate units
- **DISPlay:UNIT:PULse {WIDTh|DUTY}** - selects the method for specifying pulse widths
- **DISPlay:UNIT:RATE {FREQuency|PERiod}** - selects the rate units for sine, square, ramp, pulse, and triangle waves
- **DISPlay:UNIT:SWEEp {STARTstop|CENTerspan}** - selects the method for specifying sweep ranges
- **DISPlay:UNIT:VOLT {AMPLitudeoff|HIGHlow}** - selects the method for specifying voltage ranges
- **DISPlay:VIEW {STANdard|TEXT|GRAPh|DUAL}** - selects the view shown on the display

## DISPlay {ON|1|OFF|0}

### DISPlay?

Disables or enables the front panel display. When disabled, the front panel display turns black, and all annunciators are disabled. However, the screen remains on.

Parameter	Typical Return
{ON 1 OFF 0}, default ON	0 (OFF) or 1 (ON)
Turn display off: DISP OFF	

- Disabling the display improves command execution speed from the remote interface and provides basic security.
- Sending **DISPlay:TEXT <string>** overrides the display state. You can display a message with the display disabled.
- The display is enabled when power is cycled, or when you return to local (front panel) operation by pressing the front panel [Local] key.

## DISPlay:FOCus {CH1|CH2}

Selects the channel that is displayed "in front" on a two-channel instrument.

Parameter	Typical Return
{CH1 CH2}	CH1 or CH2
Default CH1	
Bring channel 2 to the front: DISP:FOCus CH2	

## DISPlay:TEXT "<string>"

### DISPlay:TEXT?

Displays a text message on the front panel display.

Parameter	Typical Return
Quoted string of up to 40 standard keyboard characters, default "".	"Test running. Do not touch."
Show message on display: DISP:TEXT "Test in progress..."	

- Sending **DISPlay:TEXT <string>** overrides the display state. You can display a message with the display disabled.
- While a message is displayed, information relating to the current instrument operation is not sent to the front panel display.
- The display text is unaffected by **\*RST**. It is cleared at power-on.

## DISPlay:TEXT:CLEAr

Clears the text message from the front panel display.

Parameter	Typical Return
(none)	(none)
Clear message on display: DISP:TEXT:CLE	

- With **DISPlay ON**, DISP:TEXT:CLEAr returns the display to its normal mode.
- With **DISPlay OFF**, DISP:TEXT:CLEAr clears the message and the display remains disabled. To enable the display, send **DISPPlay ON** or press the front panel [**Local**] key.
- The display text is unaffected by **\*RST**. It is cleared at power-on.

## DISPlay:UNIT:ARBRate {SRATe|FREQuency|PERiod}

Specifies whether the rate units for arbitrary waveforms are samples per second, (SRATe), Hz (FREQuency) or seconds (PER).

Parameter	Typical Return
{SRATe FREQuency PERiod}	SRAT, FREQu, or PER
Default SRATe	
Set the unit for arbitrary waveforms to seconds: DISP:UNIT:ARBR PER	

- The frequency and period of an arbitrary waveform refer to the time that it takes to run through the entire waveform once. For example, a waveform of 200 samples running at 1 MSa/s would have a period of 0.0002 s and a frequency of 5000 Hz.

## DISPlay:UNIT:PULse {WIDTh|DUTY}

Selects the method for specifying pulse duration. You can specify either the width or the duty cycle.

Parameter	Typical Return
{WIDTh DUTY}	WIDT or DUTY
Default WIDTh	
Specify pulse width as a percentage (duty cycle): DISP:UNIT:PULS DUTY	

### DISPlay:UNIT:RATE {FREQuency|PERiod}

Specifies whether the rate units for sine, square, ramp, pulse, and triangle waves are Hz (FREQ) or seconds (PER).

Parameter	Typical Return
{FREQuency PERiod} Default FREQuency	FREQ or PER
Set the units to Hz: DISP:UNIT:RATE FREQ	

### DISPlay:UNIT:SWEep {STARtstop|CENTerspan}

Selects the method for specifying sweep frequency range. You can specify the range as start and stop values or as a span around a center value.

Parameter	Typical Return
{STARtstop CENTerspan} Default STARtstop	STAR or CENT
The following examples both specify a sweep from 10 to 500 Hz: DISP:UNIT:SWE STAR FREQ:STAR 10 FREQ:STOP 500  DISP:UNIT:SWE CENT FREQ:SPAN 490 FREQ:CENT 255	

- To sweep up in frequency, set a positive frequency span; to sweep down, set a negative frequency span.

## DISPlay:UNIT:VOLT {AMPLitudeoff|HIGHlow}

Selects the method for specifying voltage ranges. You can specify a voltage range as an amplitude and an offset or as high and low values.

Parameter	Typical Return
{AMPLitudeoff HIGHlow} Default: AMPLitudeoff	AMPL or HIGH
The following examples both specify a waveform voltage from 1 to 4 V: DISP:UNIT:VOLT HIGH VOLT:LOW 1 VOLT:HIGH 4  DISP:UNIT:VOLT:AMPL VOLT 3 VOLT OFFS 2.5	

## DISPlay:VIEW {STANdard|TEXT|GRAPh|DUAL}

Selects the screen layout.

Parameter	Typical Return
{STANdard TEXT GRAPh DUAL} Default STANdard	STAN, TEXT, GRAP, or DUAL
Select the large graph display: DISP:VIEW GRAP	

- The STANdard, TEXT, GRAPh, and DUAL keywords correspond to the **Standard View**, **Large Text**, **Large Graph**, and **CH1/CH2** softkeys on the [System] > **System Setup** > **Screen Layout** menu.

## FM Subsystem

This summarizes the steps required to generate a frequency modulation (FM) waveform.

1. **Configure carrier waveform:** Use **FUNCtion**, **FREQuency**, **VOLTage**, and **VOLTage:OFFSet** to specify the carrier waveform's function, frequency, amplitude, and offset.
2. **Select modulation source (internal, external, CH1, or CH2):** **FM:SOURce**. For an external modulation source, skip steps 3 and 4.
3. **Select modulating waveform:** **FM:INTernal:FUNCtion**
4. **Set modulating frequency:** **FM:INTernal:FREQuency**
5. **Set peak frequency deviation:** **FM:DEViation**
6. **Enable FM:** **FM:STATe:ON**

The following code produces the oscilloscope image shown below.

```
FUNCTION SQU  
FREQUENCY +4.0E+05  
VOLTAGE +1.0  
VOLTAGE:OFFSET 0.0  
FM:SOURCE INT  
FM:DEVIATION +3.5e5  
FM:INTERNAL:FREQUENCY +5e4  
FM:INTERNAL:FUNCTION RAMP  
FM:STATE 1  
OUTP 1
```

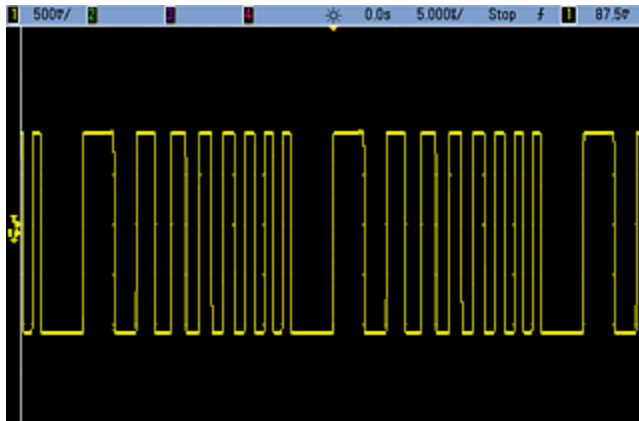

[SOURCE[1|2]:]FM[:DEVIation] {<peak\_deviation\_in\_Hz>|MINimum|MAXimum|DEFAULT}  
 [SOURCE[1|2]:]FM[:DEVIation]? [{MINimum|MAXimum}]

Sets the peak frequency deviation in Hz. This value represents the peak variation in frequency of the *modulated* waveform from the carrier frequency.

Parameter	Typical Return
1 µHz to 15.05 (limited to 150 kHz for RAMP); default 100 Hz	+1.000000000000000E+03
Set peak frequency deviation to 1 kHz: FM:DEV 1000  Set peak frequency deviation to 1 µHz: FM:DEV MIN	

- The deviation cannot exceed the carrier frequency. If you attempt to set a deviation that exceeds the carrier frequency (with FM enabled), the instrument will adjust the deviation to the maximum value allowed for that carrier frequency. *From the remote interface, a "Settings conflict" error will also be generated.*
- The carrier frequency plus the deviation cannot exceed the selected function's maximum frequency plus 100 kHz. If you attempt to set the deviation to an invalid value, the instrument adjusts it to the maximum value allowed with the present carrier frequency. The remote interface also generates a "Data out of range" error.
- If the deviation causes the carrier waveform to exceed a frequency boundary for the current duty cycle (square waveform only), the instrument will adjust the duty cycle to the maximum value allowed with the present carrier frequency. *From the remote interface, a "Settings conflict" error will also be generated.*
- If you select the *External* modulating source, the deviation is controlled by the ±5 V signal level (optionally ±1 V on the 33600 Series) on the rear-panel **Modulation In** connector. For example, if the frequency deviation is 100 kHz, then a +5 V signal level (optionally +1 V on the 33600 Series) corresponds to a 100 kHz increase in frequency. Lower external signal levels produce less deviation and negative signal levels reduce the frequency below the carrier frequency.

[SOURce[1|2]:]FM:INTernal:FREQuency {<frequency>|MINimum|MAXimum|DEFault}  
[SOURce[1|2]:]FM:INTernal:FREQuency? [{MINimum|MAXimum}]

Sets the frequency of the modulating waveform. The modulating source waveform operates at that frequency, within the frequency limits of that waveform.

Parameter	Typical Return
1 µHz to the <b>maximum allowed for the internal function</b> . Default 10 Hz	+1.0000000000000000E+04
Set the modulating frequency to 10 kHz: FM:INT:FREQ 10000	

- When you select an arbitrary waveform as the modulating source, the frequency changes to the frequency of the arbitrary waveform, which is based on the sample rate and the number of points in the arbitrary waveform.
- When using an arbitrary waveform for the modulating source, changing this parameter also changes the cached metadata representing the arbitrary waveform's sample rate. You can also change the modulating frequency of an arbitrary waveform with **FUNCTION:ARbitrary:FREQuency**, **FUNCTION:ARbitrary:PERiod**, and **FUNCTION:ARbitrary:SRATe**. These commands and the modulation frequency command are directly coupled in order to keep the arbitrary waveform behaving exactly as it was last played. If you later turn modulation off and select that same arbitrary waveform as the current function, its sample rate (and corresponding frequency based upon the number of points) will be the same as it was when played as the modulation source.
- If the internal function is TRiangle, UpRamp, or DnRamp, the maximum frequency is limited to 200 kHz on the 33500 Series or 800 kHz on the 33600 Series. If the internal function is PRBS, the frequency refers to bit rate and is limited **as shown here**.
- This command should be used only with the internal modulation source (**FM:SOURce INTernal**).

[SOURce[1|2]:]FM:INTernal:FUNCTion <function>  
[SOURce[1|2]:]FM:INTernal:FUNCTion?

This command selects the shape of the modulating waveform.

Parameter	Typical Return
{SINusoid SQUare RAMP NRAMP TRIangle NOISe PRBS ARB}, default SINusoid <b>View internal function waveforms.</b>	SIN, SQU, RAMP, NRAM, TRI, NOIS, PRBS, or ARB
Select a sine wave as the modulating waveform. FM:INT:FUNC SIN	

- This command should be used only with the internal modulation source (FM:SOURce INTernal).
- Some combinations of carrier and internal function are not allowed: PRBS carrier and PRBS internal function, ARB carrier and ARB internal function.
- You can use noise as the modulating waveform, but you cannot use noise, pulse, or DC as the carrier.



[SOURce[1|2]:]AM:SOURce {INTernal|EXTernal|CH1|CH2}  
[SOURce[1|2]:]AM:SOURce?

[SOURce[1|2]:]BPSK:SOURce {INTernal|EXTernal}  
[SOURce[1|2]:]BPSK:SOURce?

[SOURce[1|2]:]FM:SOURce {INTernal|EXTernal|CH1|CH2}  
[SOURce[1|2]:]FM:SOURce?

[SOURce[1|2]:]FSKey:SOURce {INTernal|EXTernal}  
[SOURce[1|2]:]FSKey:SOURce?

[SOURce[1|2]:]PM:SOURce {INTernal|EXTernal|CH1|CH2}  
[SOURce[1|2]:]PM:SOURce?

[SOURce[1|2]:]PWM:SOURce {INTernal|EXTernal|CH1|CH2}  
[SOURce[1|2]:]PWM:SOURce?

Selects the source of the modulating signal.

Parameter	Typical Return
{INTernal EXTernal CH1 CH2}, default INTernal. BPSK and FSKey cannot accept CH1 or CH2	INT, EXT, CH1, or CH2
Select external modulation source: AM:SOUR EXT (could also substitute FM, BPSK, FSK, PM, or PWM for AM)	

- If you select EXTERNAL, the carrier waveform is modulated with an external waveform. Specifically:
  - **AM:** The modulation depth is controlled by the  $\pm 5$  V signal level (or the optional  $\pm 1$  V signal level on the 33600 Series) on the rear-panel **Modulation In** connector. For example, if modulation depth (**AM[:DEPTH]**) is 100%, then when the modulating signal is at +5 V (or optionally +1 V on the 33600 Series), the output will be at the maximum amplitude. Similarly, a -5 V modulating signal (or optionally -1 V on the 33600 Series) produces output at minimum amplitude.
  - **FM:** If you select the *External* modulating source, the deviation is controlled by the  $\pm 5$  V signal level (optionally  $\pm 1$  V on the 33600 Series) on the rear-panel **Modulation In** connector. For example, if the frequency deviation is 100 kHz, then a +5 V signal level (optionally +1 V on the 33600 Series) corresponds to a 100 kHz increase in frequency. Lower external signal levels produce less deviation and negative signal levels reduce the frequency below the carrier frequency.
  - **PM:** With the External modulating source, deviation is controlled by the  $\pm 5$  V signal level (optionally  $\pm 1$  V on the 33600 Series) on the rear-panel **Modulation In** connector. For example, if you have set the frequency deviation to 180 degrees, then a +5 V signal level (optionally  $\pm 1$  V on the 33600 Series) corresponds to a +180 degree phase deviation. Lower external signal levels produce less deviation, and negative signal levels produce negative deviation.
  - **Pulse as Selected Function:** The pulse width or pulse duty cycle deviation is controlled by the  $\pm 5$  V signal level (optionally  $\pm 1$  V on the 33600 Series) present on the rear-panel **Modulation In** connector. For example, if you have set the pulse width deviation to 50  $\mu$ s using the **PWM:DEVIation** command, then a +5 V signal level (optionally +1 V on the 33600 Series) corresponds to a 50  $\mu$ s width increase. Lower external signal levels produce less deviation.
- With EXTERNAL source, the output phase (BPSK) or frequency (FSK) is determined by the signal level on the rear-panel **Ext Trig** connector. When a logic low is present, the carrier phase or carrier frequency is output. When a logic high is present, the phase shifted phase or hop frequency is output.
- The maximum external BPSK rate is 1 MHz, and the maximum FSK rate is 1 MHz.
- **Note:** the connector used for externally-controlled BPSK or FSK waveforms (**Trig In**) is not the same connector that is used for externally-modulated AM, FM, PM, and PWM waveforms (**Modulation In**). When used for BPSK or FSK, the **Trig In** connector does not have adjustable edge polarity and is not affected by the **TRIGger[1|2]:SLOPe** command.
- With INTERNAL source, the rate at which output phase (BPSK) or frequency (FSKey) "shifts" between the carrier phase or frequency and the alternate phase or frequency is determined by the BPSK rate (**BPSK:INTERNAL:RATE**) or FSK rate (**FSKey:INTERNAL:RATE**).
- A channel may not be its own modulation source.

## See Also

**INPut:ATTenuation[:STATe]**

**AM Subsystem**

**BPSK Subsystem**

**FM Subsystem**

**FSKey Subsystem**

**PM Subsystem**

**PWM Subsystem**

[SOURce[1|2]:]AM:STATe {ON|1|OFF|0}  
[SOURce[1|2]:]AM:STATe?

[SOURce[1|2]:]BPSK:STATe {ON|1|OFF|0}  
[SOURce[1|2]:]BPSK:STATe?

[SOURce[1|2]:]FM:STATe {ON|1|OFF|0}  
[SOURce[1|2]:]FM:STATe?

[SOURce[1|2]:]FSKey:STATe {ON|1|OFF|0}  
[SOURce[1|2]:]FSKey:STATe?

[SOURce[1|2]:]PM:STATe {ON|1|OFF|0}  
[SOURce[1|2]:]PM:STATe?

[SOURce[1|2]:]PWM:STATe {ON|1|OFF|0}  
[SOURce[1|2]:]PWM:STATe?

Enables or disables modulation.

Parameter	Typical Return
{ON 1 OFF 0}, default OFF	0 (OFF) or 1 (ON)
Enable AM (could also substitute FM, BPSK, FSK, PM, or PWM): AM:STAT ON	

- To avoid multiple waveform changes, enable modulation after configuring the other modulation parameters.
- Only one modulation mode may be enabled at a time.
- The instrument will not enable modulation with sweep or burst enabled. When you enable modulation, the sweep or burst mode is turned off.
- PWM is allowed only when pulse is the selected function.

#### See Also

[AM Subsystem](#)  
[PSK Subsystem](#)  
[FM Subsystem](#)  
[FSKey Subsystem](#)  
[PM Subsystem](#)  
[PWM Subsystem](#)

FORMat:BORDER {NORMal|SWAPped}  
FORMat:BORDER?

Sets the byte order used in binary data point transfers in the block mode.

Parameter	Typical Return
{NORMal SWAPped}, default NORMAL	NORM or SWAP
Set SWAPped order: FORM:BORD SWAP	

- **NORMAL:** most-significant byte (MSB) of each data point is first. Use this setting if you are using the Keysight IO Libraries.
- **SWAPped:** least-significant byte (LSB) of each data point is first. Most computers use this.

## FREQuency Subsystem

The FREQuency subsystem sets the instrument's output frequency. In two-channel instruments, the channels' frequencies may be coupled in various ways.

**FREQuency:COUple[:STATe] {ON|OFF|ONCE}** enables or disables coupling, or using the ONCE, one channel's is copied to the other, but not coupled to it.

**FREQuency:COUple:MODE {OFFSet|RATio}** specifies the frequency coupling mode.

**FREQuency:MODE** allows you to specify a frequency mode to use, including a sweep, frequency list, or fixed frequency.

## Example

The remaining FREQuency commands are used to generate a sweep, as summarized below:

1. **Select the waveform shape, amplitude and offset:** Use **APPLy** or the equivalent **FUNcTion**, **FREQuency**, **VOLTage**, and **VOLTage:OFFSet** commands to select the function, frequency, amplitude, and offset. You can select any non-arbitrary waveform.
2. **Set frequency boundaries of the sweep:** **FREQuency:START** and **FREQuency:STOP**, or **FREQuency:CENTer** and **FREQuency:SPAN**.
3. **Select sweep mode (linear or logarithmic):** **SWEep:SPACing**
4. **Set sweep time in seconds:** **SWEep:TIME**
5. **Select sweep trigger source:** **TRIGger[1|2]:SOURce**
6. **Set frequency at which signal on front panel Sync connector goes low during sweep (optional):** **MARKer:FREQuency**

**[SOURce[1|2]:]FREQuency {<frequency>|MINimum|MAXimum|DEFault}**  
**[SOURce[1|2]:]FREQuency? [{MINimum|MAXimum}]**

Sets the output frequency. This command is paired with **FUNcTion:PULSe:PERiod**; whichever one is executed last overrides the other.

Parameter	Typical Return
1 μHz to <b>maximum instrument frequency</b> . Default 1 kHz.	+1.000000000000000E+03
Set output frequency to 60 Hz: FREQ 60	

- **Function Limitations:** The frequency limits are function dependent, as shown in the above table. If you send a command specifying a frequency that is not in the appropriate range for the current function, an error will occur. For example, if the current function is "ramp" and you send the command **FREQ 20 MHZ**, a "Data out of range" error is generated and the frequency is set to 200 kHz (33500 Series) or 800 kHz (33600 Series), which is the maximum for a ramp waveform.

[SOURce[1|2]:]FREQUency:CENTer {<frequency>|MINimum|MAXimum|DEFault}  
[SOURce[1|2]:]FREQUency:CENTer? [{MINimum|MAXimum}]

Sets the center frequency. Used with frequency span for a frequency sweep.

Parameter	Typical Return
1 μHz to <b>maximum instrument frequency</b> , Default 550 Hz	+1.0000000000000000E+03
Set sweep center frequency to 1 kHz: FREQ:CENT 1000	

- The following equation shows how center frequency is limited by span frequency.

$$\text{Center Frequency (max)} = \text{Max. Frequency for waveform} - (\text{Span}/2)$$

- The following equation shows how center frequency relates to start and stop frequencies.

$$\text{Center Frequency} = |(\text{Stop Frequency} - \text{Start Frequency})|/2$$

[SOURce[1|2]:]FREQUency:COUple[:STATe] {ON|1|OFF|0}  
[SOURce[1|2]:]FREQUency:COUple[:STATe]?

Enables/disables frequency coupling between channels in a two-channel instrument.

Parameter	Typical Return
{ON 1 OFF 0}, default OFF	0 (OFF) or 1 (ON)
Turn on the frequency couple state: FREQ:COUP ON	

- Specifying ON starts frequency coupling as specified by **FREQUency:COUple:MODE**.
- If the current offset or ratio, combined with the current frequency settings, would cause either frequency to exceed instrument specifications, the instrument will generate an error and the exceeded frequency will clip at its maximum or minimum value.
- If setting mode to RATIO and setting RATIO to 1.0 still exceeds the specifications of either channel (for example, channel 1 is a 3 MHz sine and channel 2 is a ramp, which cannot go that high), an error message will be generated and FREQUency:COUple will be turned OFF.

[SOURce[1|2]:]FREQuency:COUPle:MODE {OFFSet|RATio}  
[SOURce[1|2]:]FREQuency:COUPle:MODE?

Sets the type of frequency coupling between frequency coupled channels; OFFSet specifies a constant frequency offset between channels; RATio specifies a constant ratio between the channels' frequencies.

Parameter	Typical Return
{OFFSet RATio}, default RATio with ratio 1.0	OFFS or RAT
Set frequency coupling mode to OFFSet: FREQ:COUP:MODE OFFS	

- Power-on default for frequency coupling is OFF.
- Specifying SOURce1 or SOURce2 is irrelevant; either syntax sets the same coupling mode for both channels.

[SOURce[1|2]:]FREQuency:COUPle:OFFSet {<frequency>|MINimum|MAXimum|DEFAULT}  
[SOURce[1|2]:]FREQuency:COUPle:OFFSet?

Sets the offset frequency when an instrument is in frequency coupled mode OFFSet.

Parameter	Typical Return
A number between plus and minus the instrument's <b>maximum frequency for the waveform</b> ; default 0.	+7.650000000000000E+05
Set frequency of channel 2 to 10.245 MHz above frequency of channel 1: FREQ:COUP:OFFS 10.245 MHZ	
Set frequency of channel 1 to 350 kHz above frequency of channel 2: SOUR2:FREQ:COUP:OFFS 350 KHZ	
Set frequency of channel 1 to 455 kHz below frequency of channel 2: SOUR2:FREQ:COUP:OFFS -455 KHZ	

- The SOURce channel (SOURce1 or SOURce2) is used as the reference channel and the OFFSet is applied to the other channel. For example, suppose the instrument is in **FREQ:COUPLE:STATE ON** and in **FREQ:COUPLE:MODE OFFSET** (frequency offset mode active), and channel 1 is currently operating at 1.0 MHz. The command SOURce1:FREQuency:COUPle:OFFSet 500 will cause channel 1 to remain at 1.0 MHz, and channel 2 to be set to 1.5 MHz. As the frequency of either channel is changed, the frequency of the other channel will change to maintain the 500 kHz offset.
  - If the frequency coupling would cause either channel to exceed instrument frequency specifications for the present functions, the command will result in an error, and the frequency will be set to its maximum or minimum limit for that channel.
  - Frequency coupling is not valid with arbitrary waveforms, but you can couple the sample rate of arbitrary waveforms.

[SOURce[1|2]:]FREQUency:COUPle:RATio <ratio>  
[SOURce[1|2]:]FREQUency:COUPle:RATio?

Sets offset ratio between channel frequencies in frequency coupled mode RATio.

Parameter	Typical Return
0.001 to 1000, default 1	+7.500000000000000E-01
Set frequency of channel 2 to twice the frequency of channel 1: FREQ:COUP:RAT 2.0	
Set frequency of channel 1 to 3.14 times the frequency of channel 2: SOUR2:FREQ:COUP:RAT 3.14	

- The SOURce channel (SOURce1 or SOURce2) is used as the reference channel and the RATIO is applied to the other channel. For example, suppose the instrument is in **FREQUency:COUPle ON** and **FREQUency:COUPle:MODE RATio**. Furthermore, suppose channel 1 is currently operating at 2 kHz, and channel 2 is at 10 kHz. The command SOURce1:FREQUency:COUPle:RATio 2.5 will cause channel 1 to remain at 2 kHz, and Channel 2 to be set to 5 kHz. As the frequency of either channel is changed, the frequency of the other channel will change to maintain the 2.5 ratio.
- If the frequency coupling would cause either channel to exceed instrument frequency specifications for the present functions, the command will result in an error, and the frequency will be set to its maximum or minimum limit for that channel.
- Frequency coupling is not valid with arbitrary waveforms, but you can couple the sample rate of arbitrary waveforms.

[SOURce[1|2]:]FREQUency:MODE {CW|LIST|SWEep|FIXed}  
[SOURce[1|2]:]FREQUency:MODE?

Sets the type of frequency mode as a continuous wave at a fixed frequency (CW or FIXed), a frequency sweep (SWEep), or a frequency list (LIST).

Parameter	Typical Return
{CW LIST SWEep FIXed}, default CW	CW, LIST, SWE, or FIX
Set frequency mode to LIST: FREQ:MODE LIST	

- If the mode is set to list, use **LIST:FREQUency** to specify the frequency list.



[SOURCE[1|2]:]FREQUENCY:SPAN {<frequency>|MINimum|MAXimum|DEFAULT}  
 [SOURCE[1|2]:]FREQUENCY:SPAN? [{MINimum|MAXimum}]

Sets frequency span (used in conjunction with the *center frequency*) for a frequency sweep.

Parameter	Typical Return
± instrument's <b>maximum frequency for the waveform</b> , default 900 Hz	+1.0000000000000000E+02
Set sweep frequency span to 100 kHz: FREQ:SPAN 100 KHZ	

- The following equation shows the limitation for the maximum frequency span:

$$\text{Frequency Span (max)} = (\text{Max. Frequency for the chosen waveform} - \text{Center Frequency}) \times 2$$

- The following equation shows the relationship between the span and the start/stop frequencies.

$$\text{Frequency Span} = \text{Stop Frequency} - \text{Start Frequency}$$

- To sweep up in frequency, set a positive frequency span; to sweep down, set a negative frequency span.

[SOURCE[1|2]:]FREQUENCY:START {<frequency>|MINimum|MAXimum|DEFAULT}  
 [SOURCE[1|2]:]FREQUENCY:START? [{MINimum|MAXimum}]

[SOURCE[1|2]:]FREQUENCY:STOP {<frequency>|MINimum|MAXimum|DEFAULT}  
 [SOURCE[1|2]:]FREQUENCY:STOP? [{MINimum|MAXimum}]

Sets the start and stop frequencies for a frequency sweep.

Parameter	Typical Return
± instrument's <b>maximum frequency for the waveform</b> , default 100 Hz	+1.0000000000000000E+02
Set sweep start and stop frequency to 100 Hz and 1 kHz, respectively: FREQ:STAR 100 FREQ:STOP 1000	

## FSKey Subsystem

The FSKey subsystem configures a frequency-shift keying (FSK) waveform.

### Example

This summarizes the steps required to generate an FSK waveform.

1. Use **FUNCTION**, **FREQUENCY**, **VOLTage**, and **VOLTage:OFFSet** commands to select the function, frequency, amplitude, and offset of the carrier waveform.
2. **Select modulation source (internal, external, CH1, or CH2): FSK:SOURce**. For an external modulation source, skip steps 3 and 4.
3. **Select alternate ("hop") frequency: FSK:FREQuency**
4. **Set FSK rate: FSK:INTernal:RATE**
5. **Enable FSK Modulation: FSK:STATe ON**

The following code produces the oscilloscope image shown below.

```
FUNCTION SQU
FREQUENCY +1e6
VOLTage +1.0
VOLTage:OFFset 0.0
FSKey:SOURce INT
FSKey:FREQuency +5e5
FSKey:INTernal:RATE +8e4
FSKey:STATe 1
OUTPut1 1
```

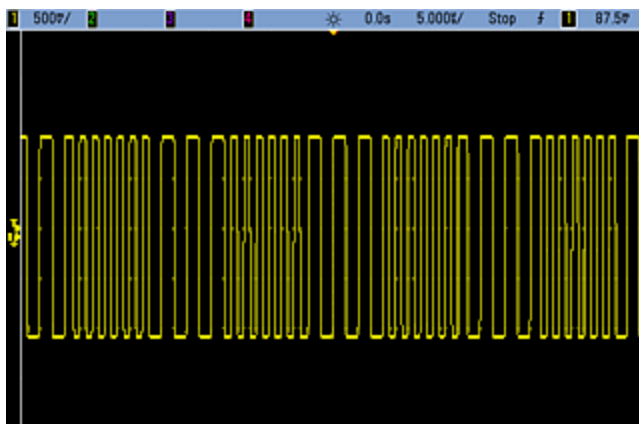

[SOURce[1|2]:]FSKey:FREQuency {<frequency>|MINimum|MAXimum|DEFault}  
[SOURce[1|2]:]FSKey:FREQuency? [{MINimum|MAXimum}]

Sets the FSK alternate (or "hop") frequency.

Parameter	Typical Return
1 $\mu$ Hz to <b>maximum instrument frequency for the waveform</b> , default 100 Hz	+1.0000000000000000E-06
Set hop frequency to 10 kHz: FSK:FREQ 10000  Set hop frequency to 1 $\mu$ Hz: FSK:FREQ MIN	

[SOURce[1|2]:]FSKey:INTernal:RATE {<rate\_in\_Hz>|MINimum|MAXimum}  
[SOURce[1|2]:]FSKey:INTernal:RATE? [{MINimum|MAXimum}]

Sets the rate at which output frequency "shifts" between the carrier and hop frequency.

Parameter	Typical Return
0.125 mHz to 1 MHz, default 10 Hz	+1.0000000000000000E+01
Set FSK rate to 10 kHz: FSK:INT:RATE 10000  Set FSK rate to 1 mHz: FSK:INT:RATE MIN	

- The FSK rate is used only with the internal source (FSK:SOURce INTernal).
- The modulating waveform is a square wave with a 50% duty cycle.

[SOURce[1|2]:]AM:SOURce {INTernal|EXTernal|CH1|CH2}  
[SOURce[1|2]:]AM:SOURce?

[SOURce[1|2]:]BPSK:SOURce {INTernal|EXTernal}  
[SOURce[1|2]:]BPSK:SOURce?

[SOURce[1|2]:]FM:SOURce {INTernal|EXTernal|CH1|CH2}  
[SOURce[1|2]:]FM:SOURce?

[SOURce[1|2]:]FSKey:SOURce {INTernal|EXTernal}  
[SOURce[1|2]:]FSKey:SOURce?

[SOURce[1|2]:]PM:SOURce {INTernal|EXTernal|CH1|CH2}  
[SOURce[1|2]:]PM:SOURce?

[SOURce[1|2]:]PWM:SOURce {INTernal|EXTernal|CH1|CH2}  
[SOURce[1|2]:]PWM:SOURce?

Selects the source of the modulating signal.

Parameter	Typical Return
{INTernal EXTernal CH1 CH2}, default INTernal. BPSK and FSKey cannot accept CH1 or CH2	INT, EXT, CH1, or CH2
Select external modulation source: AM:SOUR EXT (could also substitute FM, BPSK, FSK, PM, or PWM for AM)	

- If you select EXTERNAL, the carrier waveform is modulated with an external waveform. Specifically:
  - **AM:** The modulation depth is controlled by the  $\pm 5$  V signal level (or the optional  $\pm 1$  V signal level on the 33600 Series) on the rear-panel **Modulation In** connector. For example, if modulation depth (**AM[:DEPTH]**) is 100%, then when the modulating signal is at +5 V (or optionally +1 V on the 33600 Series), the output will be at the maximum amplitude. Similarly, a -5 V modulating signal (or optionally -1 V on the 33600 Series) produces output at minimum amplitude.
  - **FM:** If you select the *External* modulating source, the deviation is controlled by the  $\pm 5$  V signal level (optionally  $\pm 1$  V on the 33600 Series) on the rear-panel **Modulation In** connector. For example, if the frequency deviation is 100 kHz, then a +5 V signal level (optionally +1 V on the 33600 Series) corresponds to a 100 kHz increase in frequency. Lower external signal levels produce less deviation and negative signal levels reduce the frequency below the carrier frequency.
  - **PM:** With the External modulating source, deviation is controlled by the  $\pm 5$  V signal level (optionally  $\pm 1$  V on the 33600 Series) on the rear-panel **Modulation In** connector. For example, if you have set the frequency deviation to 180 degrees, then a +5 V signal level (optionally  $\pm 1$  V on the 33600 Series) corresponds to a +180 degree phase deviation. Lower external signal levels produce less deviation, and negative signal levels produce negative deviation.
  - **Pulse as Selected Function:** The pulse width or pulse duty cycle deviation is controlled by the  $\pm 5$  V signal level (optionally  $\pm 1$  V on the 33600 Series) present on the rear-panel **Modulation In** connector. For example, if you have set the pulse width deviation to 50  $\mu$ s using the **PWM:DEVIation** command, then a +5 V signal level (optionally +1 V on the 33600 Series) corresponds to a 50  $\mu$ s width increase. Lower external signal levels produce less deviation.
- With EXTERNAL source, the output phase (BPSK) or frequency (FSK) is determined by the signal level on the rear-panel **Ext Trig** connector. When a logic low is present, the carrier phase or carrier frequency is output. When a logic high is present, the phase shifted phase or hop frequency is output.
- The maximum external BPSK rate is 1 MHz, and the maximum FSK rate is 1 MHz.
- **Note:** the connector used for externally-controlled BPSK or FSK waveforms (**Trig In**) is not the same connector that is used for externally-modulated AM, FM, PM, and PWM waveforms (**Modulation In**). When used for BPSK or FSK, the **Trig In** connector does not have adjustable edge polarity and is not affected by the **TRIGger[1|2]:SLOPe** command.
- With INTERNAL source, the rate at which output phase (BPSK) or frequency (FSKey) "shifts" between the carrier phase or frequency and the alternate phase or frequency is determined by the BPSK rate (**BPSK:INTERNAL:RATE**) or FSK rate (**FSKey:INTERNAL:RATE**).
- A channel may not be its own modulation source.

## See Also

**INPut:ATTenuation[:STATe]**

**AM Subsystem**

**BPSK Subsystem**

**FM Subsystem**

**FSKey Subsystem**

**PM Subsystem**

**PWM Subsystem**

[SOURce[1|2]:]AM:STATe {ON|1|OFF|0}  
[SOURce[1|2]:]AM:STATe?

[SOURce[1|2]:]BPSK:STATe {ON|1|OFF|0}  
[SOURce[1|2]:]BPSK:STATe?

[SOURce[1|2]:]FM:STATe {ON|1|OFF|0}  
[SOURce[1|2]:]FM:STATe?

[SOURce[1|2]:]FSKey:STATe {ON|1|OFF|0}  
[SOURce[1|2]:]FSKey:STATe?

[SOURce[1|2]:]PM:STATe {ON|1|OFF|0}  
[SOURce[1|2]:]PM:STATe?

[SOURce[1|2]:]PWM:STATe {ON|1|OFF|0}  
[SOURce[1|2]:]PWM:STATe?

Enables or disables modulation.

Parameter	Typical Return
{ON 1 OFF 0}, default OFF	0 (OFF) or 1 (ON)
Enable AM (could also substitute FM, BPSK, FSK, PM, or PWM): AM:STAT ON	

- To avoid multiple waveform changes, enable modulation after configuring the other modulation parameters.
- Only one modulation mode may be enabled at a time.
- The instrument will not enable modulation with sweep or burst enabled. When you enable modulation, the sweep or burst mode is turned off.
- PWM is allowed only when pulse is the selected function.

#### See Also

[AM Subsystem](#)  
[PSK Subsystem](#)  
[FM Subsystem](#)  
[FSKey Subsystem](#)  
[PM Subsystem](#)  
[PWM Subsystem](#)

## FUNction Subsystem

The FUNction subsystem configures the instrument's output function:

- [SOURce[1|2]:]FUNction <function> - output waveform
- [SOURce[1|2]:]FUNction:ARBitrary {<filename>} - arbitrary waveform (.arb/barb) or sequence (.seq) that has previously been loaded into volatile memory with MMEMory:LOAD:DATA[1|2].
- [SOURce[1|2]:]FUNction:ARBitrary:ADVance {TRIGger|SRATe} - method for advancing to next arbitrary waveform data point.
- FUNction:ARBitrary:BALance[:STATe] {ON|1|OFF|0} - **(IQ Player option only)** state (on/off) for dual arbitrary waveform channel balancing
- FUNction:ARBitrary:BALance:GAIN {<percent>|MINimum|MAXimum|DEFine} - **(IQ Player option only)** gain balance ratio for dual arbitrary waveforms
- FUNction:ARBitrary:BALance:OFFSet{1|2} {<volts>|MINimum|MAXimum|DEFault} - **(IQ Player option only)** offset for individual channels of dual arbitrary waveforms
- [SOURce[1|2]:]FUNction:ARBitrary:FILTer {NORMal|STEP|OFF} - filter for arbitrary waveform
- [SOURce[1|2]:]FUNction:ARBitrary:FREQuency {<frequency>|MINimum|MAXimum|DEFault} - frequency of arbitrary waveform  
[SOURce[1|2]:]FUNction:ARBitrary:PERiod {<period>|MINimum|MAXimum|DEFault} - period of arbitrary waveform
- [SOURce[1|2]:]FUNction:ARBitrary:POINts? - number of points (samples) in the current arbitrary waveform
- [SOURce[1|2]:]FUNction:ARBitrary:PTPeak {<voltage>|MINimum|MAXimum|DEFault} - peak-to-peak voltage for an arbitrary waveform
- FUNction:ARBitrary:SKEW[:STATe] {ON|1|OFF|0} - **(IQ Player option only)** state (on/off) for dual arbitrary waveform skew
- FUNction:ARBitrary:SKEW:TIME [{<time>|MINimum|MAXimum|DEFault}] - **(IQ Player option only)** skew time in seconds
- [SOURce[1|2]:]FUNction:ARBitrary:SRATe {<sample\_rate>|MINimum|MAXimum|DEFault} - sample rate for arbitrary waveform
- [SOURce[1|2]:]FUNction:ARBitrary:SYNChronize - restarts arbitrary waveforms at first sample simultaneously on both waveforms
- [SOURce[1|2]:]FUNction:NOISe:BANDwidth {<bandwidth>|MINimum|MAXimum|DEFault} - bandwidth for NOISe waveform
- [SOURce[1|2]:]FUNction:PRBS:BRATe {<bit\_rate>|MINimum|MAXimum|DEFault} - bit rate for pseudo-random binary sequence (PRBS)
- [SOURce[1|2]:]FUNction:PRBS:DATA <sequence\_type> - sequence type for PRBS
- [SOURce[1|2]:]FUNction:PRBS:TRANSition[:BOTH] {<seconds>|MINimum|MAXimum|DEFault} - edge transition time for both edges of PRBS

- [SOURCE[1|2]:]FUNCTION:PULSE:DCYCLE {<percent>|MINimum|MAXimum|DEFAULT} - pulse duty cycle for pulse
- [SOURCE[1|2]:]FUNCTION:PULSE:HOLD {WIDTH|DCYCLE} - whether pulse width or duty cycle is held constant as other parameters vary
- [SOURCE[1|2]:]FUNCTION:PULSE:PERIOD {<seconds>|MINimum|MAXimum|DEFAULT} - period for a pulse
- [SOURCE[1|2]:]FUNCTION:PULSE:TRANSITION:LEADING {<seconds>|MINimum|MAXimum|DEFAULT}  
[SOURCE[1|2]:]FUNCTION:PULSE:TRANSITION:TRAILING {<seconds>|MINimum|MAXimum|DEFAULT}  
[SOURCE[1|2]:]FUNCTION:PULSE:TRANSITION[:BOTH] {<seconds>|MINimum|MAXimum|DEFAULT} - edge time for pulse
- [SOURCE[1|2]:]FUNCTION:PULSE:WIDTH {<seconds>|MINimum|MAXimum|DEFAULT} - pulse width
- [SOURCE[1|2]:]FUNCTION:RAMP:SYMMETRY {<percent>|MINimum|MAXimum|DEFAULT} - symmetry percentage for ramp
- [SOURCE[1|2]:]FUNCTION:SQUARE:DCYCLE {<percent>|MINimum|MAXimum} - duty cycle percentage for square
- [SOURCE[1|2]:]FUNCTION:SQUARE:PERIOD {<seconds>|MINimum|MAXimum|DEFAULT} - period for square



[SOURce[1|2]:]FUNCTION <function>

[SOURce[1|2]:]FUNCTION?

Selects the output function.

Parameter	Typical Return
{SINusoid SQUare TRIangle RAMP PULSe PRBS NOISe ARB DC}, default SINusoid	SIN, SQU, TRI, RAMP, PULS, PRBS, NOIS, ARB, or DC
Set output on channel 2 to sine: SOUR2:FUNC SIN	

- The selected waveform (other than an arbitrary waveform) is output using the previously selected frequency, amplitude, and offset voltage settings. Arbitrary waveforms are played according to the settings specified in the arbitrary waveform file. Brand new arbitrary waveforms inherit the current arbitrary waveform settings.
- NOISe generates white gaussian noise with adjustable bandwidth and crest factor about 3.5.
- PRBS generates pseudo-random noise using Linear Feedback Shift Register (LFSR) user selectable methods.
- ARB generates the arbitrary waveform currently selected by **FUNCTION:ARbitrary**.
- Function Limitations: If you change to a function whose maximum frequency is less than that of the current function, the frequency is adjusted to the maximum for the new function. For example, if you change a high frequency sine wave to the ramp function, the instrument will adjust the output frequency to 200 kHz (the upper limit for ramps)From the remote interface, a "Settings conflict" error will also be generated.
- Amplitude Limitations: If you change to a function whose maximum amplitude is less than that of the current function, the amplitude is adjusted to the maximum for the new function. This may occur when the output units are *Vrms* or *dBm* due to the differences in crest factor for the various output functions For example, if you change a 5 *Vrms* square wave (into 50  $\Omega$ ) to a sine wave, the instrument will adjust the amplitude to 3.536 *Vrms* (the upper limit for sine in *Vrms*). The remote interface will also generate a "Settings conflict" error.

[SOURCE[1|2]:]FUNCTION:ARbitrary {<filename>}

[SOURCE[1|2]:]FUNCTION:ARbitrary?

Selects an arbitrary waveform (.arb/.barb) or sequence (.seq) that has previously been loaded into volatile memory for the channel specified with **MMEMory:LOAD:DATA[1|2]** or **DATA:ARbitrary**. Several waveforms can be in volatile memory simultaneously.

Parameter	Typical Return
See <b>MMEMory:LOAD:DATA[1 2]</b> , for valid <filename> formats.	"INT:\MyArb103.arb"
Select an arbitrary waveform in memory on channel 2: FUNC:ARB "INT:\MyArb103.arb"  Load an arbitrary waveform from the internal drive into volatile memory. Then select and play the waveform: MMEM:LOAD:DATA "INT:\BUILTIN\Sinc.arb" FUNCTION:ARbitrary "INT:\BUILTIN\Sinc.arb" FUNCTION ARB	

- The <filename> should match the filename used to load the arbitrary waveform or sequence into volatile memory with **MMEMory:LOAD:DATA[1|2]**, **DATA:ARbitrary**, **DATA:ARbitrary:DAC**, or **DATA:SEquence**.
- When you store an arbitrary waveform segment or sequence (**MMEMory:STORe:DATA[1|2]**), the instrument's current settings (voltage values, sample rate, filter type, and so on) are stored in the segment or sequence file. When you play the file for the first time with **FUNCTION:ARbitrary**, these settings are loaded and override the instrument's current settings. If you have manually edited a segment or sequence file such that the instrument settings have been removed, the instrument settings will not be changed when you execute **FUNCTION:ARbitrary**.
- When you store an arbitrary waveform segment or sequence (**MMEMory:STORe:DATA[1|2]**), the instrument's current settings (voltage values, sample rate, filter type, and so on) are stored in the segment or sequence file. When you play the file for the first time with **FUNCTION:ARbitrary**, these settings are loaded and override the instrument's current settings. If you have manually edited a segment or sequence file such that the instrument settings have been removed, the instrument settings will not be changed when you execute **FUNCTION:ARbitrary**.

[SOURCE[1|2]:]FUNCTION:ARbitrary:ADVance {TRIGger|SRATe}  
 [SOURCE[1|2]:]FUNCTION:ARbitrary:ADVance?

Specifies the method for advancing to the next arbitrary waveform data point for the specified channel.

Parameter	Typical Return
{TRIGger SRATe}, default TRIG	TRIG or SRAT
Set advance method to trigger: FUNC:ARB:ADV TRIG	

- TRIGger causes instrument to advance to next data point with each trigger received and forces TRIGger[1|2]:SOURCE to EXTERNAL.
- SRATe causes instrument to advance to next data point at the sample rate set by FUNCTION:ARbitrary:SRATe.

[SOURCE[1|2]:]FUNCTION:ARbitrary:FILTer {NORMal|STEP|OFF}  
 [SOURCE[1|2]:]FUNCTION:ARbitrary:FILTer?

Specifies the filter setting for an arbitrary waveform.

Parameter	Typical Return
{NORMal STEP OFF}, default STEP	NORMal, STEP, or OFF
Set filter to NORMal: FUNCTION:ARbitrary:FILTer NORM	

- **NORMal** filters the data points with the filter that provides the flattest frequency response. This effectively smoothes the signal, but sharp transitions will have preshoot and overshoot.
- **STEP** filters the data points in a way that effectively smoothes the signal while minimizing the preshoot and overshoot. However, this setting has a narrower bandwidth than the NORMal setting.
- **OFF** steps from point to point at the sample rate. Moves between data points are accomplished as quickly as possible with no smoothing. If the <mode> is set to OFF, the instrument uses a filter whose bandwidth limit restricts the maximum sample rate for the arbitrary waveform to 62.5 MSa/s (33500 Series) or 250 MSa/s (33600 Series).
- To use this command on the 33600 Series, you must set FUNCTION:ARbitrary:FILTer to OFF.

[SOURce[1|2]:]FUNction:ARBitrary:FREQuency {<frequency>|MINimum|MAXimum|DEFault}  
[SOURce[1|2]:]FUNction:ARBitrary:FREQuency? {MINimum|MAXimum}

[SOURce[1|2]:]FUNction:ARBitrary:PERiod {<period>|MINimum|MAXimum}DEFault}  
[SOURce[1|2]:]FUNction:ARBitrary:PERiod? {MINimum|MAXimum}

Sets the frequency or period for the arbitrary waveform.

Parameter	Typical Return
<frequency> (Hz): Limited by the number of waveform points; default based on 40 kSa/s sample rate.	+1.0000000000000000E+03
<period> (seconds): Limited by the number of waveform points; default based on 40 kSa/s sample rate.	+1.0000000000000000E-03
Set arbitrary waveform frequency to 1000 Hz. FUNC:ARB:FREQ 1000	

- With **FUNction:ARBitrary:FILTer OFF**, the arbitrary waveform sample rate is limited to 1/4 of the maximum sample rate.
- The <frequency> ranges from 1 μHz to 31.25 MHz on the 33500 Series or 250 MHz on the 33600 Series. Frequency is also limited by the Filter setting. With **FUNction:ARBitrary:FILTer OFF**, the arbitrary waveform sample rate is limited to 62.5 MSa/s. Therefore, frequency is also reduced to 7.8125 MHz for an eight point waveform (33500 Series) or one-quarter of that for a 32-point waveform (33600 Series).
- The arbitrary waveform sample rate and frequency are not coupled to **SOUR:FREQ**, which applies to only non-arbitrary waveforms.
- The arbitrary waveform plays at a speed specified by the sample rate. When setting the frequency or period of an arbitrary waveform, the instrument changes the sample rate based on the number of points in the waveform and the new frequency or period setting. The new frequency or period may be altered slightly to meet the restrictions of Sample Rate resolution and the number of points. In other words, frequency will be recalculated from the new sample rate and number of points to ensure compatibility between the coupled parameters. This is due to math resolution of 15 digits in combination with a sample rate that can also be 15 digits.
- Changing the number of points in the waveform, or changing the sample rate with **FUNction:ARBitrary:SRATe**, changes the frequency and period settings.

### [SOURce[1|2]:]FUNCtion:ARBitrary:POINts?

Returns the number of points in the currently selected arbitrary waveform.

Parameter	Typical Return
(none)	+100000
Return the number of points in the current arbitrary waveform on channel 1: FUNC:ARB:POIN?	

- The maximum number of points depends on the instrument's memory, which is based on the **model and options**.

[SOURCE[1|2]:]FUNCTION:ARbitrary:PTPeak {<voltage>|MINimum|MAXimum|DEFault}  
 [SOURCE[1|2]:]FUNCTION:ARbitrary:PTPeak? [{MINimum|MAXimum}]

Sets peak to peak voltage.

Parameter	Typical Return
10 VDC into 50 Ω, 20 VDC into an open circuit; default 100 mV	+4.000000000000000E+00
Set peak to peak voltage to 4 V: FUNC:ARbitrary:PTPeak 4	

- *Limits Due to Amplitude:* You can set the voltage levels to a positive or negative value with the restrictions shown below. Vpp is the maximum peak-to-peak amplitude for the selected output termination (10 Vpp into 50 Ω or 20 Vpp into an open circuit).

$$V_{\text{high}} - V_{\text{low}} \leq V_{\text{pp}} (\text{max}) \text{ and } V_{\text{high}}, V_{\text{low}} \leq V_{\text{pp}} (\text{max})/2$$

- *Differences between remote and front panel operation:*
  - **Remote Interface:** Setting the high or low level from the remote interface can change the high level or low level to achieve the desired setting. In this case either a "Data out of range" or "Settings conflict" error will occur. If the high level is set below the low level, the instrument will set the low level 1 mV less than the high level. If the high level is set below the LOW limit or the instrument output specifications, the low level will be set to the LOW limit or instrument output specification and the high level will be set 1 mV above the low level. A similar set of rules applies if the low level is set incorrectly.
  - Similarly, the low level can be set above the high level from the remote interface. In this case the instrument will set the high level 1 mV larger than the low level. If the low level is set higher than the HIGH limit or the instrument output specifications, the high level will be set to the HIGH limit or instrument output specification and the low level will be set 1 mV below the high level.
  - **Front Panel:** Setting the high or low level from the front panel may clip that level setting in order to achieve the desired level setting, and a "Data out of range" error will be generated. The high level cannot be set below the low level from the front panel.
- Setting the high and low levels also sets the waveform amplitude and offset. For example, if you set the high level to +2 V and the low level to -3 V, the resulting amplitude is 5 Vpp, with a -500 mV offset.
- *Limits Due to Output Termination:* If you change the output termination setting, the displayed voltage levels will be adjusted (and no error will be generated). For example, if you set the high level to +100 mVDC and then change the output termination from 50 Ω to "high impedance", the amplitude displayed on the front panel will double to +200 mVDC. If you change from "high impedance" to 50 Ω, the displayed amplitude will be halved. Changing the output termination setting does not change the voltage present at the output terminals of the instrument. This only changes the displayed values on the front panel and the values queried from the remote interface. The voltage present at the instrument's output depends on the load connected to the instrument. See **OUTPut[1|2]:LOAD** for details.

- Limits due to voltage limits: If the voltage limits are enabled, the level settings are checked against the specified limits (**VOLTage:LIMit:HIGH**, **VOLTage:LIMit:LOW**) before a change in level is executed. If a change in output level would exceed a LIMIT setting, the level is clipped to the maximum (or minimum) value allowed that will not exceed the LIMit setting and a "Settings conflict" error will be generated.
- Limits due to Output Coupling: If two channels are coupled, limitations of setting the levels of both channels will be checked before a change in level is executed. In this case, if a change in level would exceed a LIMIT setting, or instrument output specifications for either channel, the level is clipped to the maximum (or minimum) allowable value and a "Settings conflict" error will be generated.
- To invert the waveform relative to the offset voltage, use **OUTPut[1|2]:POLarity**.

**[SOURce[1|2]:]FUNctioN:ARBitrary:SRATe {<sample\_rate>|MINimum|MAXimum|DEFault}**

**[SOURce[1|2]:]FUNctioN:ARBitrary:SRATe? {MINimum|MAXimum}**

Sets the sample rate for the arbitrary waveform.

Parameter	Typical Return
1 $\mu$ Sa/s to 250 MSa/s (33500 Series) or 1 GSa/s (33600 Series), default 40 kSa/s. Limited to 62.5 MSa/s (33500 Series) or 250 MSa/s (33600 Series) if <b>FUNctioN:ARBitrary:FILTer</b> is OFF.	+1.0000000000000000E+04
Set sample rate to 10 kSa/s: FUNC:ARB:SRAT 1e4	

- The sample rate and frequency parameter are not coupled when playing an arbitrary waveform segment. The concept of frequency does not apply for arbitrary waveform sequences.
- Setting a sample rate when not in the ARB mode will not change the frequency. For example, if the current function is sine, setting sample rate has no effect until the function changes to ARB.
- The maximum sample rate depends on the filter applied to the arbitrary waveform. See **FUNctioN:ARBitrary:FILTer** for details.

## [SOURce[1|2]:]FUNCTION:ARbitrary:SYNChronize

Causes two independent arbitrary waveforms to synchronize to first point of each waveform (two-channel instruments only).

Parameter	Typical Return
(none)	(none)
Load an internal Haversine waveform into channel 1 and a custom waveform from a USB drive into channel 2. Set both sample rates to 100 kSa/s and then synchronize both channels to the first point of each waveform:  MMEM:LOAD:DATA "Int:\Builtin\HAVERSINE.arb" FUNC:ARB "Int:\Builtin\HAVERSINE.ARB" FUNC ARB FUNC:ARB:SRATE 1E+05  MMEM:LOAD:DATA2 "USB:\MyFiles\TestDUT3.arb" SOUR2:FUNC:ARB "USB:\MyFiles\TestDUT3.arb" SOUR2:FUNC ARB SOUR2:FUNC:ARB:SRAT 1E+05  FUNC:ARB:SYNC	

- This command stops and restarts the arbitrary waveforms on both channels at whatever sample rates they happen to be set.
- If the two arbitrary waveforms have the same number of points and sample rate, they will remain synchronized over multiple repetitions; otherwise, they will only be synchronized at the beginning and after numbers of repetitions that happen to be multiples of the number of points in both waveforms. For example, if you synchronize an 8-point waveform and a 10-point waveform, they will re-synchronize after 40, 80, and 120 repetitions.
- This functionality is similar to using burst mode, but it operates in continuous wave mode.
- This command also works with burst, sweep, and modulation, when trying to synchronize two arbitrary waveforms.



[SOURCE[1|2]:]FUNCTION:NOISE:BANDwidth {<bandwidth>|MINimum|MAXimum|DEFAULT}  
 [SOURCE[1|2]:]FUNCTION:NOISE:BANDwidth? [{MINimum|MAXimum}]

Sets bandwidth of noise function.

Parameter	Typical Return
1 mHz to instrument's <b>maximum frequency</b> , default 100 kHz	+6.000000000000000E+03
Set bandwidth to 20 kHz: FUNC:NOISE:BWIDth 20000	

- The Noise function produces white gaussian noise with a Crest Factor of 4.6.
- The noise bandwidth is continuously adjustable to place more noise energy in the frequency range from 0 Hz to the specified noise bandwidth frequency.

[SOURCE[1|2]:]FUNCTION:PRBS:BRATe {<bit\_rate>| MINimum|MAXimum|DEFAULT}  
 [SOURCE[1|2]:]FUNCTION:PRBS:BRATe? [{MINimum|MAXimum}]

Sets the pseudo-random binary sequence (PRBS) bit rate.

Parameter	Typical Return
1 mbit/s to maximum allowed for the instrument, default 1000 bit/s	+1.920000000000000E+04
Set bit rate to 19,200 bits per second FUNC:PRBS:BRATe 19200	

- A PRBS waveform using polynomial PN<sub>x</sub> is generated by a shift register of *x* bits, and the output waveform begins with *x* sample periods of high output. Sample period is the reciprocal of the sample rate (**FUNCTION:PRBS:BRATe**), and the channel's **Sync** pulse indicates the waveform's start. For example, if the PRBS uses PN23 with sample rate 500 Hz, the output begins with 46 ms of high output (23 x 2 ms).
- The bit rate is independent of the data sequence length.

[SOURce[1|2]:]FUNCTION:PRBS:DATA <sequence\_type>

[SOURce[1|2]:]FUNCTION:PRBS:DATA?

Sets the pseudo-random binary sequence (PRBS) type. Setting the sequence type sets the length and feedback values as shown below.

Parameter	Typical Return
33500 Series: {PN7 PN9 PN11 PN15 PN20 PN23} 33600 Series: PN3 through PN32 (all 30 possible values from 3 to 32)  Value after PN corresponds to maximum shift register length in bits. Default is PN7.	PN# (PN3 through PN9) or PN## (PN10 through PN32), where each # is one digit.
Set data format to PN23: FUNC:PRBS:DATA PN23	

- SYNC output may be active during a PRBS function, unlike the **NOISe** function. The SYNC output marks the first data bit of a PRBS waveform.

- A PRBS waveform using polynomial PN<sub>x</sub> is generated by a shift register of *x* bits, and the output waveform begins with *x* sample periods of high output. Sample period is the reciprocal of the sample rate (**FUNCTION:PRBS:BRATe**), and the channel's **Sync** pulse indicates the waveform's start. For example, if the PRBS uses PN23 with sample rate 500 Hz, the output begins with 46 ms of high output (23 x 2 ms). The polynomials are shown below.

Sequence Type	Polynomial	Length
PN3	$x^3 + x^2 + 1$	3
PN4	$x^4 + x^3 + 1$	4
PN5	$x^5 + x^3 + 1$	5
PN6	$x^6 + x^5 + 1$	6
PN7	$x^7 + x^6 + 1$	7
PN8	$x^8 + x^6 + x^5 + x^4 + 1$	8
PN9	$x^9 + x^5 + 1$	9
PN10	$x^{10} + x^7 + 1$	10
PN11	$x^{11} + x^9 + 1$	11
PN12	$x^{12} + x^6 + x^4 + x^1 + 1$	12
PN13	$x^{13} + x^4 + x^3 + x^1 + 1$	13
PN14	$x^{14} + x^5 + x^3 + x^1 + 1$	14
PN15	$x^{15} + x^{14} + 1$	15
PN16	$x^{16} + x^{15} + x^{13} + x^4 + 1$	16
PN17	$x^{17} + x^{14} + 1$	17
PN18	$x^{18} + x^{11} + 1$	18
PN19	$x^{19} + x^6 + x^2 + x^1 + 1$	19
PN20	$x^{20} + x^{17} + 1$	20
PN21	$x^{21} + x^{19} + 1$	21
PN22	$x^{22} + x^{21} + 1$	22
PN23	$x^{23} + x^{18} + 1$	23
PN24	$x^{24} + x^{23} + x^{22} + x^{17} + 1$	24
PN25	$x^{25} + x^{22} + 1$	25
PN26	$x^{26} + x^6 + x^2 + x^1 + 1$	26
PN27	$x^{27} + x^5 + x^2 + x^1 + 1$	27

Sequence Type	Polynomial	Length
PN28	$x^{28} + x^{25} + 1$	28
PN29	$x^{29} + x^{27} + 1$	29
PN30	$x^{30} + x^6 + x^4 + x^1 + 1$	30
PN31	$x^{31} + x^{28} + 1$	31
PN32	$x^{32} + x^{22} + x^2 + x^1 + 1$	32

[SOURCE[1|2]:]FUNCTION:PRBS:TRANSITION[:BOTH] {<seconds>|MINimum|MAXimum|DEFAULT}  
[SOURCE[1|2]:]FUNCTION:PRBS:TRANSITION[:BOTH]? [{MINimum|MAXimum}]

Sets PRBS transition edge time on both edges of a PRBS transition.

Parameter	Typical Return
33500 Series: 8.4 ns (default) to 1 μsec, limited as described below 33600 Series: 2.9 ns up to 4 Vpp, and 3.3 ns above 4Vpp to 1 μsec; limited as described below	+1.0000000000000000E-08
Set edge time to 10 ns for the leading and trailing edges (two methods): FUNC:PRBS:TRAN 10 ns FUNC:PRBS:TRAN .000000010	

- The default "BOTH" keyword is optional and allows simultaneous control of the leading and trailing edges of the PRBS waveform.
- The edge time applies to both the rising and falling edges, and represents the time between the 10% and 90% thresholds of each edge.
- The specified edge time must fit within the specified period. The instrument will limit the edge time as needed to accommodate the specified bit rate. From the remote interface, a "Settings conflict" error will also be generated.

[SOURCE[1|2]:]FUNCTION:PULSE:DCYCLE {<percent>|MINimum|MAXimum|DEFAULT}  
 [SOURCE[1|2]:]FUNCTION:PULSE:DCYCLE? [{MINimum|MAXimum}]

Sets pulse duty cycle.

Parameter	Typical Return
0 to 100, limited as described below; default 10	+5.000000000000000E+01
Set duty cycle to 50%: FUNC:PULS:DCYC 50	

- The **FUNCTION:PULSE:DCYCLE** and **FUNCTION:PULSE:WIDTH** commands affect the same parameter. In some applications, it is natural to adjust pulse width directly (in seconds); in others, adjusting duty cycle seems more natural. When frequency is adjusted, if pulse width was most recently adjusted as duty cycle on the front panel, then duty cycle will be kept constant as frequency or period changes. However, if pulse width was the last setting, then pulse width will be kept constant as frequency or period changes. See **FUNCTION:PULSE:HOLD**.

- The pulse duty cycle is defined as:

$$\text{Duty Cycle} = 100 \times \text{Pulse Width} \div \text{Period}$$

Pulse width is the time from the 50% threshold of a pulse's rising edge to the 50% threshold of the next falling edge.

- The pulse duty cycle range is 0 percent to 100 percent. However, the pulse duty cycle is limited by *minimum pulse width* and *edge time* restrictions, which prevent you from setting exactly 0 percent or 100 percent. For example, for a 1 kHz pulse waveform, you are typically restricted to pulse duty cycles in the range 0.002 percent to 99.998 percent. This is limited by the minimum pulse width of 16 ns on the 33500 Series or 5 ns up to 4 Vpp and 8 ns up to 10 Vpp on the 33600 Series.
- Restrictions Based on Pulse Width: The specified pulse duty cycle must conform to the following restrictions determined by the *minimum pulse width*. The instrument will adjust pulse duty cycle as needed to accommodate the specified period. *From the remote interface, a "Settings conflict" error will also be generated.*

$$\text{Duty Cycle} \geq 100(\text{Minimum Pulse Width} / \text{Period})$$

and

$$\text{Duty Cycle} \leq 100 (1 - \text{Minimum Pulse Width} / \text{Period})$$

On the 33500 Series, the minimum pulse width is 16 ns. On the 33600 Series, the minimum pulse width is 5 ns up to 4 Vpp and 8 ns up to 10 Vpp.

- *Restrictions Based On and Affecting Edge Time:* The specified pulse duty cycle may affect the edge time. The edge time is adjusted first, and then the duty cycle is adjusted to accommodate the specified period, conforming to the following restriction. From the remote interface, a "Settings conflict" error will also be generated.

$$\text{Duty Cycle} \geq [(0.8 \times \text{Leading Edge Time}) + (0.8 \times \text{Trailing Edge Time})] / \text{Period} \times 100$$

and

$$\text{Duty Cycle} \leq [1 - [(0.8 \times \text{Leading Edge Time}) + (0.8 \times \text{Trailing Edge Time})] / \text{Period}] \times 100$$

[SOURCE[1|2]:]FUNCTION:PULSE:HOLD {WIDTH|DCYCLE}  
 [SOURCE[1|2]:]FUNCTION:PULSE:HOLD?

Sets the pulse waveform parameter (either pulse width or duty cycle) to be held constant as other parameters are varied.

Parameter	Typical Return
{WIDTH DCYCLE}, default WIDTH	WIDT or DCYC
Set the instrument to hold duty cycle for pulse waveforms: FUNC:PULS:HOLD DCYC	

- **WIDTH:** the instrument holds the pulse width setting (in seconds) constant as the period is varied. If a command to set a duty cycle value is received, the duty cycle is converted to the equivalent pulse width. If pulse width modulation (PWM) is turned on, the pulse width and width deviation are held as the period is varied. Duty cycle deviation commands are converted to width deviations.

Minimum width and edge time restrictions apply. May cause a change in the selected edge times, pulse width, or both.

- **DCYCLE:** the instrument holds the pulse duty cycle setting (in percent) constant as the period is varied. If a command to set a pulse width value is received, the width is converted to the equivalent duty cycle. If pulse width modulation (PWM) is turned on, the pulse duty cycle and the duty cycle deviation are held as the period is varied. Width deviation commands are converted to duty cycle deviation values.

Minimum width and edge time restrictions apply. May cause a change in the selected edge times, duty cycle, or both.

**NOTE**

The FUNCTION:PULSE:HOLD command does not limit period settings. The pulse width or duty cycle may be adjusted if necessary to accommodate a new period setting.

[SOURCE[1|2]:]FUNCTION:PULSE:PERiod {<seconds>|MINimum|MAXimum|DEFault}  
 [SOURCE[1|2]:]FUNCTION:PULSE:PERiod? [{MINimum|MAXimum}]

Sets the period for pulse waveforms. This command is paired with the **FREQUENCY** command; the one executed last overrides the other, as frequency and period specify the same parameter.

Parameter	Typical Return
From reciprocal of instrument's <b>maximum frequency</b> up to 1,000,000 s.  Default 1 ms	+2.0000000000000000E-07
Set the period to 500 ms: FUNC:PULS:PER .5 or FUNC:PULS:PER 500 ms	

- The specified period must be greater than the sum of the pulse width and the edge time. The instrument will adjust edge time and pulse width as needed to accommodate the specified period. From the remote interface, a "Settings conflict" error will also be generated. The edge time is minimized first, and then the width (or duty cycle) is adjusted as shown below.

$$\text{Period} \geq [\text{Pulse Width} + ((\text{Lead Edge Time} + \text{Trail Edge Time}) * 0.625)]$$

- This command affects the period (and frequency) for all waveform functions (not just pulse). For example, if you select a period using FUNCTION:PULSE:PERiod and then change the output function to sine wave, the specified period will be used for the new function.
- Function Limitations: If you change to a function whose minimum period exceeds the value set by this command, the period is adjusted to the new function's minimum pulse. For example, if you set a period of 2 μs and then change to the ramp function, the instrument adjusts the period to 5 μs (the minimum for ramps). From the remote interface, a "Settings conflict" error will also be generated.

[SOURce[1|2]:]FUNction:PULSe:TRANsition[:BOTH] {<seconds>|MINimum|MAXimum|DEFault}

[SOURce[1|2]:]FUNction:PULSe:TRANsition:LEADing {<seconds>|MINimum|MAXimum|DEFault}

[SOURce[1|2]:]FUNction:PULSe:TRANsition:LEADing? [{MINimum|MAXimum}]

[SOURce[1|2]:]FUNction:PULSe:TRANsition:TRAILing {<seconds>|MINimum|MAXimum|DEFault}

[SOURce[1|2]:]FUNction:PULSe:TRANsition:TRAILing? [{MINimum|MAXimum}]

Sets the pulse edge time on the leading, trailing, or both edges of a pulse.

Parameter	Typical Return
33500 Series: 8.4 ns (default) to 1 $\mu$ sec, limited as described below 33600 Series: 2.9 ns up to 4 Vpp, and 3.3 ns above 4 Vpp, to 1 $\mu$ sec; limited as described below	+1.0000000000000000E-08
Set leading edge time to 10 ns (two methods): FUNC:PULS:TRAN:LEADing 10 ns FUNC:PULS:TRAN:LEADing .000000010	

- The leading edge time applies to rising edge, and represents the time from the 10% threshold to the 90% threshold of the edge; the trailing edge represents the time from the 90% threshold to the 10% threshold.
- The specified edge time must fit within the specified pulse width and period. The instrument will limit the edge time to accommodate the specified pulse width or duty cycle. From the remote interface, a "Settings conflict" error will also be generated.



[SOURCE[1|2]:]FUNCTION:PULSE:WIDTH {<seconds>|MINimum|MAXimum|DEFAULT}  
 [SOURCE[1|2]:]FUNCTION:PULSE:WIDTH? [{MINimum|MAXimum}]

Sets pulse width.

Parameter	Typical Return
16 ns (33500 Series), 5 ns (33600 Series up to 4 Vpp), or 8 ns (33600 Series up to 10 Vpp) up to approximately 1,000,000 s, limited as described below; default 100 µs	+5.0000000000000000E-03
Set pulse width to 5 ms (two methods): FUNC:PULS:WIDT 5 ms FUNC:PULS:WIDT .005	

- The **FUNCTION:PULSE:DCYCLE** and **FUNCTION:PULSE:WIDTH** commands affect the same parameter. In some applications, it is natural to adjust pulse width directly (in seconds); in others, adjusting duty cycle seems more natural. When frequency is adjusted, if pulse width was most recently adjusted as duty cycle on the front panel, then duty cycle will be kept constant as frequency or period changes. However, if pulse width was the last setting, then pulse width will be kept constant as frequency or period changes. See **FUNCTION:PULSE:HOLD**.
- Pulse width is the time from the 50% threshold of a pulse's rising edge to the 50% threshold of the next falling edge.
- The specified pulse width must be less than the difference between the *period* and the *minimum pulse width* as shown below. The instrument will adjust pulse edge time first and then limit pulse width as needed to accommodate the period. From the remote interface, a "Settings conflict" error will also be generated.

$$\text{Pulse Width} \leq \text{Period} - W_{\text{min}}$$

- The specified pulse width must also be less than the difference between the *period* and the *edge time* as shown below. The instrument will adjust pulse edge time first and then limit pulse width as needed to accommodate the period. From the remote interface, a "Settings conflict" error will also be generated.

$$\text{Pulse Width} \leq [\text{Period} - ((\text{Leading Edge Time} + \text{Trailing Edge Time}) * 0.625)]$$

- The pulse width must also be greater than the total time of one edge as shown below.

$$\text{Pulse Width} \geq [(\text{Leading Edge Time} + \text{Trailing Edge Time}) * 0.625]$$

[SOURCE[1|2]:]FUNCTION:RAMP:SYMMetry {<percent>|MINimum|MAXimum|DEFAULT}  
 [SOURCE[1|2]:]FUNCTION:RAMP:SYMMetry? [{MINimum|MAXimum}]

Sets the symmetry percentage for ramp waves.

Parameter	Typical Return
0 to 100, default 100	+5.000000000000000E+01
Set symmetry to 50%: FUNC:RAMP:SYMM 50	

- Symmetry represents the amount of time per cycle that the ramp wave is rising (assuming that the waveform polarity is not inverted).

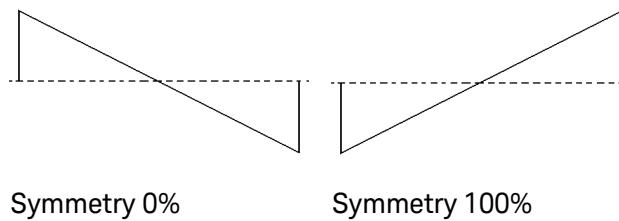

- For ramp waveforms, the **APPLY:RAMP** command overrides the current symmetry setting and selects 100%. To set a symmetry other than 100%, select the ramp waveform output with the **FUNCTION RAMP** command, then use **FUNCTION:RAMP:SYMMetry** to set the symmetry.
- The symmetry setting is remembered when you change from ramp wave to another function. When you return to the ramp wave function, the previous symmetry is used.
- When ramp is the modulating waveform for AM, FM, PM, or PWM, the symmetry setting does not apply. The instrument always uses a ramp waveform with 100% symmetry.

[SOURCE[1|2]:]FUNCTION:SQUare:DCYCLE {<percent>|MINimum|MAXimum}  
 [SOURCE[1|2]:]FUNCTION:SQUare:DCYCLE? [{MINimum|MAXimum}]

Sets duty cycle percentage for square wave.

Parameter	Typical Return
0.01 to 99.99, subject to limitation of 16 ns minimum pulse width; default 50	+5.000000000000000E+01
Set duty cycle to 30%: FUNC:SQU:DCYC 30  Sets the duty cycle to its minimum value: FUNC:SQU:DCYC MIN	

- Duty cycle represents the amount of time per cycle that the square wave is at a high level (assuming normal polarity).
- For square waveforms, **APPLY:SQUare** replaces the current duty cycle setting with 50%. To set a duty cycle other than 50%, select the square wave with **FUNCTION SQUare**, then use **FUNCTION:SQUare:DCYCLE**.
- The duty cycle setting is remembered when you change from square wave to another function. When you return to square wave, the previous duty cycle is used.
- Limits Due to Frequency: As frequency is increased, minimum and maximum duty cycle limits are adjusted to maintain a minimum pulse width of 16 ns (33500 Series), 5 ns (33600 Series up to 4 Vpp), or 8 ns (33600 Series up to 10 Vpp). For example, at 1 MHz the minimum duty cycle on the 33500 Series is 1.60% and maximum duty cycle is 98.40%. At 10 MHz, the minimum duty cycle is 16.00% and the maximum duty cycle is 84.00%.
- If you select a square waveform as the modulating waveform for AM, FM, PM, or PWM, the instrument always uses a square wave with 50% duty cycle.

[SOURCE[1|2]:]FUNCTION:SQUare:PERiod {<seconds>|MINimum|MAXimum|DEFAULT}  
 [SOURCE[1|2]:]FUNCTION:SQUare:PERiod? [{MINimum|MAXimum}]

Sets period for square wave.

Parameter	Typical Return
From reciprocal of <b>maximum square wave frequency</b> to 1,000,000 s, default 1 ms	+5.000000000000000E-01
Set period to 500 ms (two methods): FUNC:SQUare:PER .5 FUNC:SQUare:PER 500 ms	

- Function Limitations: If you change to a function whose minimum period exceeds the value set by this command, the period is adjusted to the new function's minimum pulse. For example, if you set a period of 2  $\mu$ s and then change to the ramp function, the instrument adjusts the period to 5  $\mu$ s (the minimum for ramps). From the remote interface, a "Settings conflict" error will also be generated. From the remote interface, a "Settings conflict" error will also be generated.

### The commands shown below all require the IQ player option.

FUNCTION:ARBITrary:BALance[:STATe] {ON|1|OFF|0}  
 FUNCTION:ARBITrary:BALance[:STATe]?

(IQ Player option only)

Enables or disables channel balancing for dual arbitrary waveforms (**FUNCTION:ARBITrary:BALance:GAIN** and **FUNCTION:ARBITrary:BALance:OFFSet**).

Parameter	Typical Return
{ON 1 OFF 0}, default OFF	0 (OFF) or 1 (ON)
Load an arbitrary waveform from the USB drive and set up the balance gain (channel 2 down by 1.02%) and balance offsets (120 mV for channel 1 and -38 mV for channel 2): FUNC:ARB "USB:\qam32.barb" FUNC:ARB:BAL:GAIN 1.02 FUNC:ARB:BAL:OFFS1 0.12 FUNC:ARB:BAL:OFFS2 -0.038 FUNC:ARB:BAL ON	

- This feature can be used to compensate for minor variations in the load impedances on the two channels, or for minor differences between the two channels of information in the original dual arbitrary waveform file.
- When the <state> is on, both channels must stay on the same amplifier range.
- This setting is stored as part of the instrument state, and it is affected by **\*RST**.

**FUNCTION:ARbitrary:BALance:GAIN** {<percent>|MINimum|MAXimum|DEFine}  
**FUNCTION:ARbitrary:BALance:GAIN?** [{MINimum|MAXimum}]

(IQ Player option only)

Sets the gain balance ratio for dual arbitrary waveforms.

Parameter	Typical Return
-30 to +30	+1.02000000E+000
Load an arbitrary waveform from the USB drive and set up the balance gain (channel 2 down by 1.02%) and balance offsets (120 mV for channel 1 and -38 mV for channel 2): FUNC:ARB "USB:\qam32.barb" FUNC:ARB:BAL:GAIN 1.02 FUNC:ARB:BAL:OFFS1 0.12 FUNC:ARB:BAL:OFFS2 -0.038 FUNC:ARB:BAL ON	

- Both channels must stay on the same amplifier range.
- A value of 0 means that both channels use their current amplitude. A positive value means that the amplitude of channel 2 is pushed down, while the amplitude of channel 1 remains constant, a negative value pushes channel 1 down while holding channel 2 constant. See the following table for examples.

<percent>	Channel 1 Amplitude %	Channel 2 Amplitude %
-20	80	100
-10	90	100
0	100	100
10	100	90
20	100	80

- This command is enabled by **FUNCTION:ARbitrary:BALance ON**.
- This setting is stored as part of the instrument state, and it is affected by **\*RST**.

**FUNCTION:ARbitrary:BALance:OFFSet{1|2} {<volts>|MINimum|MAXimum|DEFault}**  
**FUNCTION:ARbitrary:BALance:OFFSet{1|2}? [MINimum|MAXimum]**

(IQ Player option only)

Specifies the offset (in volts) added to the dual arbitrary waveform offset for the specified channel.

Parameter	Typical Return
A floating point value, limited by the dual arbitrary waveform amplitude.	+1.00000000E+000
Load an arbitrary waveform from the USB drive and set up the balance gain (channel 2 down by 1.02%) and balance offsets (120 mV for channel 1 and -38 mV for channel 2): FUNC:ARB "USB:\qam32.barb" FUNC:ARB:BAL:GAIN 1.02 FUNC:ARB:BAL:OFFS1 0.12 FUNC:ARB:BAL:OFFS2 -0.038 FUNC:ARB:BAL ON	

- Both channels must stay on the same amplifier range.
- This command is enabled by **FUNCTION:ARbitrary:BALance ON**.
- This setting is stored as part of the instrument state, and it is affected by **\*RST**.

**FUNCTION:ARbitrary:SKEW[:STATe] {ON|1|OFF|0}**  
**FUNCTION:ARbitrary:SKEW[:STATe]?**

(IQ Player option only)

Enables or disables skew time compensation (**FUNCTION:ARbitrary:SKEW:TIME**). This is always OFF for modulated signals, sweeps, lists, and bursts.

Parameter	Typical Return
{ON 1 OFF 0}, default OFF	0 (OFF) or 1 (ON)
Set the skew time to compensate for channel 1 being behind channel 2 by 140 picoseconds: FUNCTION:ARbitrary:SKEW:TIME 1.4e-10 FUNCTION:ARbitrary:SKEW ON	

- Skew compensation is typically determined empirically, using an oscilloscope and then set one time. That one-time setup will then be valid until the DUT or test equipment configuration changes.
- The value specified by this command is not stored in the instrument state. It is stored in non-volatile memory and is not affected by **\*RST**.

**FUNCTION:ARbitrary:SKEW:TIME** [{<time>|MINimum|MAXimum|DEFault}]

**FUNCTION:ARbitrary:SKEW:TIME?** [{MINimum|MAXimum}]

(IQ Player option only)

Sets a small time difference between the channels to compensate for minor variations in timing at the connector output plane or at the device under test (DUT). Note than **FUNC:ARB:SKEW[:STATe] OFF** for modulated signals, sweeps, lists, and bursts.

Parameter	Typical Return
A floating point value in the range of $\pm 4$ ns. Default 0.	+1.40000000E-010
Set the skew time to compensate for channel 1 being behind channel 2 by 140 picoseconds: FUNCTION:ARbitrary:SKEW:TIME 1.4e-10 FUNCTION:ARbitrary:SKEW ON	

- Channels may exhibit slight timing variations at the output connector plane due to variations in internal circuitry between the two channels. They may exhibit slight timing variations at the device under test (DUT) due to variations in signal paths, including such things as switches and cable lengths.
- A positive value delays channel 2, and a negative value delays channel 1.
- The value specified by this command is not stored in the instrument state. It is stored in non-volatile memory and is not affected by **\*RST**.

## HCOPY Subsystem

The HCOpy subsystem produces screen images ("screen shots") of the front panel display.

### Example

The following example captures and returns the front panel display image in BMP format.

```
HCOP:SDUM:DATA:FORM BMP
HCOP:SDUM:DATA?
```

## HCOPy:SDUMp:DATA?

Returns the front panel display image ("screen shot")

Parameter	Typical Return
(none)	<i>(A definite-length binary block containing the image.)</i>  Definite-length block data allows any type of device-dependent data to be transmitted as a series of 8-bit binary data bytes. This is particularly useful for transferring large quantities of data or 8-bit extended ASCII codes.
Capture and return the display image: HCOP:SDUM:DATA?	

- The image format (PNG or BMP) is specified by **HCOPy:SDUMp:DATA:FORMat**.

## HCOPy:SDUMp:DATA:FORMat {PNG|BMP}

### HCOPy:SDUMp:DATA:FORMat?

Specifies the image format for images returned by **HCOPy:SDUMp:DATA?**.

Parameter	Typical Return
{PNG BMP}, default PNG	PNG or BMP
Set the display image format to BMP HCOP:SDUM:DATA:FORM BMP	

## IEEE-488 Common Commands

This subsystem contains commands and queries associated with the IEEE-488 standards:

\*CLS - Clear status

\*ESE *<enable\_value>* - Event status enable

\*ESR? - Event status register query

\*IDN? - Instrument identification

\*OPC - Set operation complete bit

\*OPC? - Wait for current operation to complete

\*OPT? - Show installed options

\*PSC {0|1} - Power-on status clear

\*RCL {0|1|2|3|4} - Recall instrument state

\*RST - Reset instrument to **factory defaults**

\*SAV {0|1|2|3|4} - Save instrument state

\*SRE *<enable\_value>* - Service request enable (enable bits in enable register of Status Byte Register group)



\*STB? - Read status byte

\*TRG - Trigger command

\*TST? - Self-test

\*WAI - Wait for all pending operations to complete

## Registers

Some of the IEEE-488 commands are associated with various registers in the instrument. These registers are described below.

### Standard Event Register

The following table describes the Standard Event Register.

Bit Number	Bit Name	Decimal Value	Definition
0	Operation Complete	1	All commands before and including *OPC have been executed.
1	(not used)	2	(Reserved for future use)
2	Query Error	4	The instrument tried to read the output buffer but it was empty. Or, a new command line was received before a previous query has been read. Or, both the input and output buffers are full.
3	Device-Specific Error	8	A device-specific error, including a self-test error, calibration error or other device-specific error occurred. See <b>Error Messages</b> .
4	Execution Error	16	An execution error occurred. <b>Error Messages</b>
5	Command	32	A command syntax error occurred. <b>Error Messages</b>
6	(not used)	64	(Reserved for future use)
7	Power On	128	Power has been cycled since the last time the event register was read or cleared.

## Status Byte Register

The following table describes the Status Byte Register.

Bit Number	Bit Name	Decimal Value	Definition
0	(not used)	1	(Reserved for future use)
1	(not used)	2	(Reserved for future use)
2	Error Queue	4	One or more errors in the Error Queue. Use <b>SYSTem:ERRor?</b> to read and delete errors.
3	Questionable Data Summary	8	One or more bits are set in the Questionable Data Register (bits must be enabled, see <b>STATus:QUESTionable:ENABLE</b> ).
4	Message Available	16	Data is available in the instrument's output buffer.
5	Standard Event Summary	32	One or more bits are set in the Standard Event Register (bits must be enabled, see <b>*ESE</b> ).
6	Master Summary	64	One or more bits are set in the Status Byte Register and may generate a Request for Service (RQS). Bits must be enabled using <b>*SRE</b> .
7	Operation Register	128	One or more bits are set in the Operation Status Register. Bits are enabled using <b>STATus:OPERation:ENABLE</b> .

### \*CLS

*Clear Status Command.* Clears the event registers in all register groups. Also clears the error queue.

Parameter	Typical Return
(none)	(none)
Clear event register bits and error queue: *CLS	

**\*ESE <enable\_value>**

**\*ESE?**

*Event Status Enable Command and Query.* Enables bits in the **enable register** for the **Standard Event Register** group. The selected bits are then reported to bit 5 of the Status Byte Register.

Parameter	Typical Return
Decimal sum of the bits in the register (table below), default 0. For example, to enable bit 2 (value 4), bit 3 (value 8), and bit 7 (value 128), the decimal sum would be 140 (4 + 8 + 128). Default 0.	+48
Enable bit 4 (value 16) and bit 5 (value 32) in the enable register: *ESE 48	

- Use **\*PSC** to control whether the Standard Event enable register is cleared at power on. For example, **\*PSC 0** preserves the enable register contents through power cycles.
- **\*CLS** does not clear enable register, does clear event register.

**\*ESR?**

*Standard Event Status Register Query.* Queries the event register for the **Standard Event Register** group. Register is read-only; bits not cleared when read.

Parameter	Typical Return
(none)	+24
Read the event register (bits 3 and 4 are set). *ESR	

- Any or all conditions can be reported to the Standard Event summary bit through the enable register. To set the enable register mask, write a decimal value to the register using **\*ESE**.
- Once a bit is set, it remains set until cleared by this query or **\*CLS**.

## \*IDN?

*Identification Query.* Returns instrument's identification string.

Parameter	Typical Return
(none)	Keysight Technologies,33522B,XXXXXXXXXX,0.179-1.19-8.88-52-00
Return the instrument's identification string: *IDN?	

- Identification string contains four comma separated fields:
  - Manufacturer name
  - Model number
  - Serial number
  - Revision code
- Identification string is in the following format for the 33500 Series instruments:

Keysight Technologies,[Model Number],[10-char Serial Number],A.aaa-B.bb-C.cc-DD-EE

**A.aaa** = Firmware revision  
**B.bb** = Front panel FW revision  
**C.cc** = Power supply controller FW revision  
**DD** = FPGA revision  
**EE** = PCBA revision

- Identification string is in the following format for the 33600 Series instruments:

Keysight Technologies,[Model Number],[Serial Number],A.aa.aa-B.bb-CC-DD-EE

**A.aa.aa** = Firmware revision  
**B.bb** = Front panel FW revision  
**CC** = Main board revision  
**DD** = FPGA revision  
**EE** = PCBA revision

### \*OPC

Sets "Operation Complete" (bit 0) in the Standard Event register at the completion of the current operation.

Parameter	Typical Return
(none)	(none)
Set Operation Complete bit: *OPC	

- The purpose of this command is to synchronize your application with the instrument.
- Used in triggered sweep, triggered burst, list, or arbitrary waveform sequence modes to provide a way to poll or interrupt the computer when the \*TRG or INITiate[:IMMediate] is complete.
- Other commands may be executed before Operation Complete bit is set.
- The difference between \*OPC and \*OPC? is that \*OPC? returns "1" to the output buffer when the current operation completes. This means that no further commands can be sent after an \*OPC? until it has responded. In this way an explicit polling loop can be avoided. That is, the IO driver will wait for the response.

### \*OPC?

Returns 1 to the output buffer after all pending commands complete.

Parameter	Typical Return
(none)	1
Return 1 when all previous commands complete: *OPC?	

- The purpose of this command is to synchronize your application with the instrument.
- Other commands cannot be executed until this command completes.
- The difference between \*OPC and \*OPC? is that \*OPC? returns "1" to the output buffer when the current operation completes. This means that no further commands can be sent after an \*OPC? until it has responded. In this way an explicit polling loop can be avoided. That is, the IO driver will wait for the response.

### \*OPT?

Returns a quoted string identifying any installed options.

Parameter	Typical Return
(none)	"0,MEM,SEC,IQP"
Returns installed options (example: standard timebase, extended memory, security, IQ player) *OPT?	

**\*PSC {0|1}**

**\*PSC?**

*Power-On Status Clear.* Enables (1) or disables (0) clearing of two specific registers at power on:

- Standard Event enable register (**\*ESE**).
- Status Byte condition register (**\*SRE**).
- Questionable Data Register
- Standard Operation Register

Parameter	Typical Return
{0 1}, default 1	0 or 1
Disables power-on clearing of affected registers: <b>*PSC 0</b>	

- This setting is non-volatile through a power-cycle. If it therefore useful for GPIB connection as follows:

**\*PSC 0** to disable enable clearing

**\*ESE 128** to enable power-on event

**\*SRE 32** to enable a SRQ on std event

This short program now provides a GPIB SRQ signal when the unit is turned on.

**\*RCL {0|1|2|3|4}**  
**\*SAV {0|1|2|3|4}**

Recalls (\*RCL) or saves (\*SAV) instrument state in specified non-volatile location. Previously stored state in location is overwritten (no error is generated).

**NOTE**

For 33600 Series instruments, the state files associated with \*SAV and \*RCL are saved in files called STATE\_0.STA through STATE\_4.STA. These files are located in the Settings directory of internal memory. You can manage these files using **MMEMory commands**.

Parameter	Typical Return
{0 1 2 3 4}	(none)
Recall state from location 1: *RCL 1	

- The instrument has five non-volatile storage locations to store instrument states. Location 0 holds the instrument power down state. Use locations 1, 2, 3, and 4 to store other states. You can configure the instrument to recall the power-down state when power is restored (**MEM:STAT:REC:AUTO**).
- State storage "remembers" the selected function (including arbitrary waveforms), frequency, amplitude, DC offset, duty cycle, symmetry, as well as any modulation parameters in use. Also remembers front panel display state (**DISP**).
- When shipped from the factory, locations 1 through 4 are empty, and location 0 has power-on state.
- From the remote interface only, you can use location 0 to store a fifth instrument state (you cannot store to this location from the front panel). However, location 0 is overwritten when power is cycled.
- You can **assign a user-defined name** to each of locations 0 through 4.
- States stored in memory are not affected by **\*RST**.
- If you delete an arbitrary waveform from non-volatile memory after storing the instrument state, the waveform data is lost and the instrument will not output the waveform when the state is recalled; it will output the built-in "exponential rise" instead.
- The front panel uses **MMEMory subsystem** for state storage.

## \*RST

Resets instrument to **factory default state**, independent of **MEMory:STATe:RECall:AUTO** setting.

Parameter	Typical Return
(none)	(none)
Reset the instrument: *RST	

- Does not affect stored instrument states, stored arbitrary waveforms, or I/O settings; these are stored in non-volatile memory.
- Aborts a sweep or burst in progress.

## \*SRE <enable\_value>

### \*SRE?

*Service Request Enable*. This command enables bits in the **enable register** for the **Status Byte Register** group.

Parameter	Typical Return
Decimal sum of the bits in the register (table below), default 0. For example, to enable bit 2 (value 4), bit 3 (value 8), and bit 7 (value 128), the decimal sum would be 140 (4 + 8 + 128). Default 0.	+24
Enable bits 3 and 4 in the enable register: *SRE 24	

- To enable specific bits, specify the decimal value corresponding to the binary-weighted sum of the bits in the register. The selected bits are summarized in the "Master Summary" bit (bit 6) of the Status Byte Register. If any of the selected bits change from 0 to 1, the instrument generates a Service Request signal.
- **\*CLS** clears the event register, but not the enable register.
- **\*PSC** (power-on status clear) determines whether Status Byte enable register is cleared at power on. For example, **\*PSC 0** preserves the contents of the enable register through power cycles.
- Status Byte enable register is not cleared by **\*RST**.



### \*STB?

*Read Status Byte Query.* This command queries the condition register for the **Status Byte Register** group.

Parameter	Typical Return
(none)	+40
Read condition register (with bits 3 and 5 set): *STB?	

- Similar to a Serial Poll, but processed like any other instrument command. Register is read-only; bits not cleared when read.
- Returns same result as a Serial Poll, but "Master Summary" bit (bit 6) is not cleared by \*STB?.
- Power cycle or \*RST clears all bits in condition register.
- Returns a decimal value that corresponds to the binary-weighted sum of all bits set in the register. For example, with bit 3 (value 8) and bit 5 (value 32) set (and corresponding bits enabled), the query returns +40.

### \*TRG

*Trigger Command.* Triggers a sweep, burst, arbitrary waveform advance, or **LIST** advance from the remote interface if the bus (software) trigger source is currently selected (**TRIGger[1|2]:SOURce BUS**).

Parameter	Typical Return
(none)	(none)
Send immediate trigger to initiate a burst: BURS:STAT ON BURS:MODE TRIG TRIG:SOUR BUS *TRG	

## \*TST?

*Self-Test Query.* Performs a complete instrument self-test. If test fails, one or more error messages will provide additional information. Use **SYSTem:ERRor?** to read error queue.

Parameter	Typical Return
(none)	+0 (pass) or +1 (one or more tests failed)
Perform self-test: *TST?	

- A power-on self-test occurs when you turn on the instrument. This limited test assures you that the instrument is operational.
- A complete self-test (**\*TST?**) takes approximately 15 seconds. If all tests pass, you have high confidence that the instrument is fully operational.
- Passing **\*TST** displays "Self-Test Passed" on the front panel. Otherwise, it displays "Self-Test Failed" and an error number. See **Service and Repair - Introduction** for instructions on contacting support or returning the instrument for service.

## \*WAI

Configures the instrument to wait for all pending operations to complete before executing any additional commands over the interface.

Parameter	Typical Return
(none)	(none)
Wait until all pending operations complete. *WAI	

- For example, you can use this with the **\*TRG** command to ensure that the instrument is ready for a trigger:

```
*TRG;*WAI;*TRG
```

## Registers

The instrument uses three different type of registers to enable, flag and track instrument features.

- An enable register defines which bits in the event register will be reported to the Status Byte register group. You can write to or read from an enable register.
- A condition register continuously monitors the state of the instrument. The bits in the condition register are updated in real time and the bits are not latched or buffered.

- An event register is a read-only register that latches the various events from the condition register. There is no buffering in this register; while an event bit is set, subsequent events corresponding to that bit are ignored.

## INITiate Subsystem

The INITiate subsystem controls how the instrument moves from the "idle" state to the "wait for trigger" state. You may do this one channel at a time, or for both channels with the "ALL" keyword.

### Example

This program uses **INITiate[1|2][:IMMEDIATE]** with **TRIGger[1|2]:SOURce** and **TRIGger[1|2]:COUNT**. The **TRIG:SOUR EXT** command configures the channel for external triggering, and **TRIG:COUNT** sets the trigger count to 10. The **INITiate** command places the instrument in the "wait-for-trigger" state. The trigger will occur when the rear-panel **Ext Trig** line is pulsed (high by default). The channel will return to idle after the trigger count of 10 has been satisfied. Another INIT command would then be necessary to restart the acceptance of triggers from the external trigger input line.

```
INIT:CONT OFF
TRIG:SOUR EXT
TRIG:COUNT 10
INIT
```

**INITiate[1|2]:CONTinuous {ON|1|OFF|0}**

**INITiate[1|2]:CONTinuous?**

**INITiate:CONTinuous:ALL {ON|1|OFF|0}**

Specifies whether the trigger system for one or both channels (ALL) always returns to the "wait-for-trigger" state (ON) or remains in the "idle" state (OFF), ignoring triggers until **INITiate:IMMEDIATE** is issued.

Parameter	Typical Return
{ON 1 OFF 0}, default ON	0 (OFF) or 1 (ON)
Configure both channels for continuous trigger: INIT:CONT:ALL ON	

- Once the channel is triggered, it leaves the wait-for-trigger state and enters the "action-in-progress" state (for example, burst-in-progress or sweep-in-progress). The action-in-progress state can be lengthy, and during this state triggers are ignored (will not count against number of triggers specified by **TRIGger[1|2]:COUNT**).
- With **INIT:CONT ON**, the trigger count is meaningless because there is no way to distinguish the completion of one trigger count from the first trigger of the next trigger count. If you need counted triggers, you must set **INIT:CONT OFF**.

## INITiate[1|2][:IMMEDIATE]

### INITiate[:IMMEDIATE]:ALL

Changes state of triggering system for both channels (ALL) from "idle" to "wait-for-trigger" for the number of triggers specified by TRIGger[1|2]:COUNT.

- Once the channel is triggered, it leaves the wait-for-trigger state and enters the "action-in-progress" state (for example, burst-in-progress or sweep-in-progress). The action-in-progress state can be lengthy, and during this state triggers are ignored (will not count against number of triggers specified by TRIGger[1|2]:COUNT).

Parameter	Typical Return
(none)	(none)
Change both channels to the wait-for-trigger state: INIT:IMM:ALL	

- The trigger system is armed by INITiate[:IMMEDIATE]. Once the trigger count is satisfied, the trigger system returns to idle state and ignores further triggers. The triggered function will be left in whatever state is achieved with the count of triggers. Rearming the trigger system with another INITiate[:IMMEDIATE] allows further triggers to apply.
- Use ABORT to return instrument to idle.
- If the specified channel has INIT:CONT set ON, INITiate[1|2]:IMMEDIATE and INIT[:IMMEDIATE]:ALL have no effect on the trigger system and error -213 will be generated.

INPut:ATTenuation[:STATe] {ON|1|OFF|0}  
 INPut:ATTenuation[:STATe]?

Specifies whether the modulation input on the 33600 Series works with signals up to the 5 V level (ON) or the 1 V level (OFF).

Parameter	Typical Return
{ON 1 OFF 0}, default ON	0 (OFF) or 1 (ON)
Specify that the modulation input is to work with signals up to 5 V: INP:ATT ON	

- You can set this from the front panel modulation parameters screen if the modulation source is set to External.

## LIST Subsystem

Configures list of frequencies to be output by instrument. This permits faster frequency change to a predetermined list of frequencies. You may advance frequencies by either an external trigger, an internal trigger, or a BUS trigger. List is initiated by FREQUency:MODE LIST.

**LIST\_DWELL** - sets amount of time each frequency in list is generated.

**LIST\_FREQUENCY** - Specify up to 128 frequencies as a list (frequencies may also be read from or saved to a file using MMEMory:LOAD:LIST[1|2] and MMEMory:STORe:LIST.

**LIST\_FREQUENCY\_POINTS** - Returns number of points in a frequency list.

For LIST programming example, see [Create a List of Frequencies](#).

[SOURce[1|2]:]LIST:DWELL {<seconds>|MINimum|MAXimum}  
 [SOURce[1|2]:]LIST:DWELL? [{MINimum|MAXimum}]

Sets dwell time, the amount of time each frequency in a frequency list is generated.

Parameter	Typical Return
1 $\mu$ s to 1000 s, default 1 s	+1.2000000000000000E+01
Set dwell time for channel 1 to 12 s: LIST:DWEL 12	

- The instrument generates each frequency in a frequency list for the specified dwell time, when TRIGger[1|2]:SOURce is IMMEDIATE.

[SOURce[1|2]:]LIST:FREQuency <freq1>[, <freq2>, etc.]  
[SOURce[1|2]:]LIST:FREQuency?

Specifies frequency values in a frequency list.

Parameter	Typical Return
List of 1 to 128 frequencies, each 1 μHz to maximum instrument frequency (up to 200 kHz for triangle and ramp). Default list: 100 Hz, 1000 Hz, and 550 Hz.	2.17800000E+006,3.14000000E+003, 6.28318000E+006
Set channel 1 frequency list to three frequency values: LIST:FREQ 2.718E6, 3.14E3, 6.28318E6	

- This command overwrites the previous list with the new list.

[SOURce[1|2]:]LIST:FREQuency:POINts? [{MINimum|MAXimum}]

Returns number of frequencies in current frequency list.

Parameter	Typical Return
[{MINimum MAXimum}]	+17
Return number of entries in the channel 1 frequency list: LIST:FREQ:POIN?	

- The default list has three frequencies: 100 Hz, 1000 Hz, and 550 Hz.
- MINimum is 1, MAXimum is 128.

## LXI Subsystem

The LXI subsystem supports LAN eXtensions for Instrumentation (LXI) functionality.

**LXI:IDENtify[:STATE] {ON|1|OFF|0}**  
**LXI:IDENtify[:STATE]?**

Turns the LXI Identify Indicator on the display on or off.

Parameter	Typical Return
{ON 1 OFF 0}	0 (OFF) or 1 (ON)
Turn on the LXI Identify Indicator: LXI:IDEN ON	

- The LXI Identify indicator helps you identify the device associated with the LAN address.
- A **\*RST** turns LXI Identify Indicator off.
- Pressing the LOCAL key turns off the LXI Identify Indicator.

**LXI:MDNS:ENABle {ON|1|OFF|0}**  
**LXI:MDNS:ENABle?**

Disables or enables the Multicast Domain Name System (mDNS).

Parameter	Typical Return
{ON 1 OFF 0}, default ON	0 (OFF) or 1 (ON)
Turn mDNS ON: LXI:MDSN:ENAB ON	

- Setting is enabled after **SYSTem:SECurity:IMMediate**, **\*RST**, power-on, or LAN reset.

**LXI:MDNS:HNAME[:RESolved]?**

Returns the resolved (unique) mDNS hostname in the form *<mDNS Hostname>-N*. The *N* is an integer appended if necessary to make the name unique. The desired name may be truncated, if necessary, to make room for the appended integer.

Parameter	Typical Return
(none)	"A-335xxx-00107", where xxx is the last three characters of the model number, and 00107 is the last five digits of the serial number.
Return the resolved mDNS hostname: LXI:MDNS:HNAME:RESolved?	



**LXI:MDNS:SNAME:DESired <name>**

**LXI:MDNS:SNAME:DESired?**

Sets the desired mDNS service name.

Parameter	Typical Return
Quoted string of up to 63 characters, default is Keysight <Model_Name> Arbitrary Waveform Generator - <Serial_Number>".	"Keysight 33xxxx Arbitrary Waveform Generator - 99999", where xxxx is the last four characters of the model number, and 99999 is the last five digits of the serial number.
Set the mDNS service name to "Waveform Generator": LXI:MDNS:SNAME:DES "Waveform Generator"	

- This setting is non-volatile; it will not be changed by power cycling or \*RST.
- Setting is set to default value after **SYSTEM:SECURITY:IMMEDIATE**.

**LXI:MDNS:SNAME[:RESolved]?**

Returns the resolved (unique) mDNS service name in the form <Desired mDNS Service Name>(N). The N is an integer appended if necessary to make the name unique. The desired name may be truncated, if necessary, to make room for the appended integer.

Parameter	Typical Return
(none)	"Keysight 33xxxx Arbitrary Waveform Generator - 99999", where xxxx is the last four characters of the model number, and 99999 is the last five digits of the serial number.
Return resolved mDNS service name: LXI:MDNS:SNAME:RESolved?	

- The resolved mDNS service name is the desired service name (**LXI:MDNS:SNAME:DESired**), possibly with "(N)" appended, where N is an integer, only if it is necessary to make the name unique.

## LXI:RESet

Resets LAN settings to a known operating state, beginning with DHCP. If DHCP fails, it uses AutoIP. It also clears the WebUI password, if set.

Parameter	Typical Return
(none)	(none)
Reset the LAN settings: LXI:RES	

- Depending on your network, the LAN interface may take several seconds to restart after this command is sent.
- If the LAN interface or specific LAN services (VXI-11, sockets, and so on) have been disabled by SYSTem:COMMunicate:ENABLE, you must separately re-enable the interface or services and cycle power on the instrument for the LAN to be operational.

## LXI:REStart

Restarts the LAN with the current settings as specified by the SYSTem:COMM:LAN commands.

Parameter	Typical Return
(none)	(none)
Restart the LAN interface: LXI:REST	

- Depending on your network, the LAN interface may take several seconds to restart after this command is sent.
- If the LAN interface or specific LAN services (VXI-11, sockets, and so on) have been disabled by SYSTem:COMMunicate:ENABLE, you must separately re-enable the interface or services and cycle power on the instrument for the LAN to be operational.

## MARKer Subsystem

The MARKer subsystem configures the point within an arbitrary waveform, sweep, or burst at which the front panel **Sync** signal goes low.

### Commands and Queries

- [SOURce[1|2]:]MARKer:CYCLE {<cycle\_num>|MINimum|MAXimum|DEFault} - cycle of a burst at which **Sync** signal goes low
- [SOURce[1|2]:]MARKer:FREQuency {<frequency>|MINimum|MAXimum|DEFault} - frequency at which **Sync** signal goes low
- [SOURce[1|2]:]MARKer:POINt {<sample\_number>|MINimum|MAXimum} - point in an arbitrary waveform at which **Sync** signal goes low

If and only if the SYNC:MODE is set to MARKer, each of these commands causes sync/marker to transition to high at start of burst, sweep, or arbitrary waveform. **OUTPut:SYNC:POLarity** may reverse this.

[SOURce[1|2]:]MARKer:CYCLE {<cycle\_num>|MINimum|MAXimum|DEFAULT}  
 [SOURce[1|2]:]MARKer:CYCLE? [{MINimum|MAXimum}]

Sets the marker cycle number at which the front panel **Sync** signal goes low in a burst mode operation. **OUTPut:SYNC:POLarity** may reverse this.

Parameter	Typical Return
Whole number from 2 to number of cycles in the burst plus one (NCYCles+1), default 2	+2.0000000000000000E+03
Set the marker cycle to 2000: MARK:CYCL 2000	

- This is valid only if burst is enabled and **OUTP:SYNC:MODE** is MARKer.
- With burst enabled, the marker cycle must be less than or equal to the number of cycles in the burst plus one. Attempting to set the marker cycle outside this range will set marker cycle equal to middle of burst. From the remote interface, a "Settings conflict" error will also be generated.

[SOURce[1|2]:]MARKer:FREQUENCY {<frequency>|MINimum|MAXimum|DEFAULT}  
 [SOURce[1|2]:]MARKer:FREQUENCY? [{MINimum|MAXimum}]

Sets the marker frequency at which the front panel **Sync** signal goes low during a sweep. **OUTPut:SYNC:POLarity** may reverse this.

Parameter	Typical Return
Any frequency between start and stop frequency, default 500 Hz	+2.0000000000000000E+03
Set marker frequency to 2 kHz: MARK:FREQ 2000	

- This is valid only if sweep is enabled and **OUTP:SYNC:MODE** is MARKer.
- When sweep is enabled, marker frequency must be between start frequency and stop frequency. Attempting to set the marker cycle outside this range will set marker frequency to start frequency or frequency (whichever is closer). From the remote interface, a "Settings conflict" error will also be generated.

[SOURCE[1|2]:]MARKer:POINT {<sample\_number>|MINimum|MAXimum}  
 [SOURCE[1|2]:]MARKer:POINT? [{MINimum|MAXimum}]

Sets the sample number at which the front panel **Sync** signal goes low within the active arbitrary waveform. **OUTPut:SYNC:POLarity** may reverse this.

Parameter	Typical Return
Whole number from 4 to number of samples in waveform, minus 3; default is midpoint of arbitrary waveform	+1.0000000000000000E+01
Set marker point to 10th sample in waveform: MARK:POIN 10	

- Command only sets marker point in currently active arbitrary waveform (**FUNCTION:ARbitrary**), not in a sequence.
- Command is valid only under these conditions:
  - **OUTPut:SYNC:MODE** set to MARK, FUNC set to ARB, **FREQuency:MODE** set to CW
  - **OUTPut:SYNC:MODE** set to CARR, FUNC set to ARB, **BURSt** ON.
  - **OUTPut:SYNC:MODE** set to CARR, FUNC set to ARB, **FREQuency:MODE** set to SWEEP
  - **OUTPut:SYNC:MODE** set to MARK, internal modulation active, and either **FUNCTION** set to ARB or a modulating waveform's internal function is set to ARB
  - **OUTPut:SYNC:MODE** set to MARK, external modulation active, and **FUNCTION** set to ARB

## MEMory Subsystem

The MEMory subsystem works with instrument state files that are saved to (**\*SAV**) and recalled from (**\*RCL**) non-volatile storage locations numbered 0 through 4.

### NOTE

For 33600 Series instruments, the state files associated with \*SAV and \*RCL are saved in files called STATE\_0.STA through STATE\_4.STA. These files are located in the Settings directory of internal memory. You can manage these files using **MMEMory commands**.

## Example

```
MEM:STAT:DEL 3
*SAV 3
MEM:STAT:VAL? 3
MEM:STAT:NAME 3,PATS_STATE
MEM:STAT:CAT?
```

## Commands and Queries

- **MEMory:NStates?** - return total number of state storage memory locations
- **MEMory:STATe:CATalog?** - list the names associated with all five state storage locations
- **MEMory:STATe:DELeTe {0|1|2|3|4}** - delete the contents of a state storage location

- **MEMory:STATe:NAME {0|1|2|3|4} [,<name>]** - assign a custom name to a state storage locations
- **MEMory:STATe:RECall:AUTO {ON|1|OFF|0}** - specify whether the power-down state is recalled from location 0 on power-on
- **MEMory:STATe:VALid? {0|1|2|3|4}** - determine whether a storage location contains a valid state

### MEMory:NSTates?

Returns the total number of memory locations available for state storage (always +5, including memory location 0).

Parameter	Typical Return
(none)	+5
Return number of state storage locations: MEM:NST?	

### MEMory:STATe:CATalog?

Returns the names assigned to locations 0 through 4.

Parameter	Typical Return
(none)	"AUTO_RECALL","STATE_1","STATE_2","STATE_3","STATE_4"
Return location names: MEM:STAT:CAT?	

- Default names are "AUTO\_RECALL", "STATE\_1", "STATE\_2", "STATE\_3", and "STATE\_4".
- You can name location 0, but the name is overwritten when power is cycled and a new power-down state is stored there.

### MEMory:STATe:DELeTe {0|1|2|3|4}

Deletes a state storage location.

Parameter	Typical Return
{0 1 2 3 4}	(none)
Delete the contents of storage location 1: MEM:STAT:DEL 1	

- Default names are "AUTO\_RECALL", "STATE\_1", "STATE\_2", "STATE\_3", and "STATE\_4".
- Although you may delete the state in location 0, the instrument will be restored to its power-down state at the next power up.
- Attempting to recall a state from an empty location generates an error.

**MEMory:STATe:NAME {0|1|2|3|4} [,<name>]**

**MEMory:STATe:NAME? {0|1|2|3|4}**

Names a storage location.

Parameter	Typical Return
An unquoted string of up to 12 characters. The first character must be a letter (A-Z). Others can be letters, numbers (0-9), or underscores ("_"). If name omitted, factory default name is used.	TEST_RACK_1
Rename location 1: MEM:STAT:NAME 1,TEST_RACK_1	

- Default names are "AUTO\_RECALL", "STATE\_1", "STATE\_2", "STATE\_3", and "STATE\_4".
- You can name location 0, but the name is overwritten when power is cycled and a new power-down state is stored there.
- May assign same name to different locations.
- Deleting a storage location's contents (**MEMory:STATe:DELeTe**) resets associated name to factory default ("AUTO\_RECALL", "STATE\_1", "STATE\_2", "STATE\_3", or "STATE\_4").
- State names are unaffected by **\*RST**.

**MEMory:STATe:RECall:AUTO {ON|1|OFF|0}**

**MEMory:STATe:RECall:AUTO?**

Disables or enables automatic recall of instrument state in storage location "0" at power on.

Parameter	Typical Return
{ON 1 OFF 0}, default ON	0 (OFF) or 1 (ON)
Disable automatic recall of power-down state: MEM:STAT:REC:AUTO OFF	

- OFF is equivalent to Factory Reset (**\*RST**) on power-up.

**MEMory:STATe:VALid? {0|1|2|3|4}**

Indicates whether a valid state is currently stored in a storage location.

Parameter	Typical Return
{0 1 2 3 4}	0 (no valid state stored) or 1 (valid state stored)
Return state of memory location 3: MEM:STAT:VAL 3?	

- Use this before sending **\*SAV** to avoid accidentally overwriting a state.

## MMEMory Subsystem

The MMEMory subsystem manages the file system in the instrument or on an external USB file system. The file system can store and load several file formats.

The "INT:\\" flash memory file system inside the instrument is always present. If a USB file storage device (sometimes called a flash drive, thumb drive, or jump drive) is plugged into the front panel USB port, it appears as "USB:\\" to the instrument.

### Example

The following code produces the sequence shown below. Note that the long **DATA:SEQuence** command splits across lines for readability purposes.

```
FUNC:ARB:SRATE 10E3
FUNC:ARB:FILTER OFF
FUNC:ARB:PTPEAK 10
DATA:ARB dc_ramp, 0.1, 0.1, 0.1, 0.1, 0.1, 0.2, 0.4, 0.6, 0.8, 1.0
DATA:ARB dc5v, 1.0, 1.0, 1.0, 1.0, 1.0, 1.0, 1.0, 1.0, 1.0, 1.0
DATA:ARB dc2_5v, 0.5, 0.5, 0.5, 0.5, 0.5, 0.5, 0.5, 0.5, 0.5, 0.5
DATA:ARB dc0v, 0.0, 0.0, 0.0, 0.0, 0.0, 0.0, 0.0, 0.0, 0.0, 0.0
DATA:SEQuence #3128"seqExample", "dc_
ramp", 0, once, highAtStart, 5, "dc5v", 2, repeat, maintain, 5,
      "dc2_5v", 2, repeat, lowAtStart, 5, "dc0v", 2, repeat, maintain, 5
FUNC:ARB dc_ramp
MMEM:STORE:DATA "INT:\dc_ramp.arb"
FUNC:ARB dc5v
MMEM:STORE:DATA "INT:\dc5v.arb"
FUNC:ARB dc2_5v
MMEM:STORE:DATA "INT:\dc2_5.arb"
FUNC:ARB dc0v
MMEM:STORE:DATA "INT:\dc0v.arb"
FUNC:ARB seqExample
MMEM:STORE:DATA "INT:\seqExample.seq"
DATA:VOL:CLEAR <--- erase all waveforms to show LOAD will restore all
waveforms
MMEM:LOAD:DATA "INT:\seqExample.seq"
FUNC ARB
FUNC:ARB "INT:\seqExample.seq"
OUTPUT ON
```

The seqExample.seq file is as shown below:

```
File Format:1.10
Sample Rate:10000.000000
High Level:5.000000
Low Level:0.000000
Filter:"off"
Header:Arb Name, Repeat Count, Play Control,Marker Mode, Marker Point
dc_ramp.arb,1,"once","highAtStart",5
dc5v.arb,2,"repeat","maintain",5
dc2_5v.arb,2,"repeat","lowAtStart",5
dc0v.arb,2,"repeat","maintain",5
```

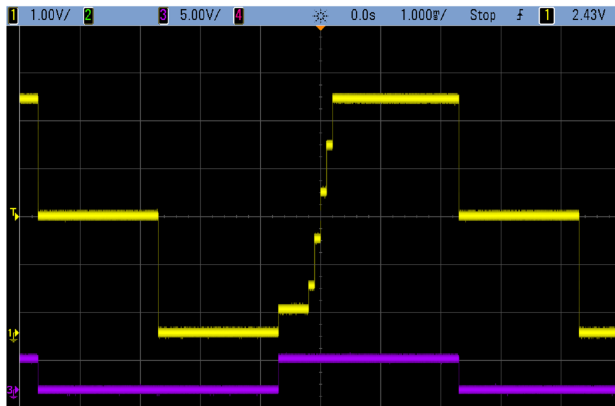



## Commands and Queries

The MMEMory subsystem includes the following commands and queries.

**MMEMory:CATalog[:ALL]? [<folder>]** - lists available and used space and files on Mass Memory device

**MMEMory:CATalog:DATA:ARbitrary? [<folder>]** - lists arbitrary waveforms and sequences on Mass Memory device

**MMEMory:CATalog:STATe? [<folder>]** - lists available and used space and state (\*.sta) files present on Mass Memory device

**MMEMory:CDIRectory <folder>** - changes to a directory

**MMEMory:CDIRectory?**

**MMEMory:COpy <file1>,<file2>** - copies a file on Mass Memory device

**MMEMory:COpy:SEquence <source>,<destination>** - copies a sequence and its associated arbitrary waveforms on Mass Memory device

**MMEMory:DELeTe <file>** - removes files from Mass Memory device

**MMEMory:DOWNload:DATA <binary\_block>** - downloads data from the host computer to instrument's Mass Memory

**MMEMory:DOWNload:FNAME <filename>** - specifies file name for downloading data from the computer to instrument's Mass Memory

**MMEMory:LOAD:ALL <filename>** - loads instrument state file

**MMEMory:LOAD:DATA[1|2] <filename>** - loads arbitrary waveform from file

**MMEMory:LOAD:LIST[1|2] <filename>** - loads frequency list from file

**MMEMory:LOAD:STATe <filename>** - loads saved instrument state from file

**MMEMory:MDIRectory <folder>** - makes a new directory (folder)

**MMEMory:MOVE <file1>,<file2>** - moves a file on Mass Memory device

**MMEMory:RDIRectory <folder>** - removes a directory

**MMEMory:STORe:ALL <filename>** - saves instrument state file

**MMEMory:STORe:DATA[1|2] <filename>** - saves arbitrary waveform to file

**MMEMory:STORe:LIST[1|2] <filename>** - saves active frequency list to file

**MMEMory:STORe:STATe <filename>** - stores instrument state to file

**MMEMory:UPLoad? <filename>** - uploads contents of a file from instrument to host computer

## Folder and file formats

Many MMEMory commands refer to folders and files. These have specific structures, described below.

### Format for a <folder>

- The format for <folder> is "<drive>:<path>", where <drive> can be INTernal or USB, and <path> is an absolute folder path.
  - INTernal specifies the internal flash file system. USB specifies a front panel USB storage device.
  - Absolute paths begin with "\" or "/" and start at the root folder of <drive>.
  - The folder name specified in <path> cannot exceed 240 characters.
  - The specified folder must exist and cannot be marked hidden or system.
  - If <drive>:<path> is omitted, the folder specified by **MMEMory:CDIRectory** is used.
  - If <drive> is omitted:
    - The path is treated as a relative path and appended to the folder specified by **MMEMory:CDIRectory**.
    - Absolute paths are NOT allowed.

### Format for a <file>

- The format for <file1> and <file2> is "[<drive>:<path>]<file\_name>", where <drive> can be INTernal or USB, and <path> must be an absolute folder path.
  - INTernal specifies the internal flash file system. USB specifies a front panel USB storage device.
  - If <drive>:<path> is omitted, the folder specified by **MMEMory:CDIRectory** is used.
  - Absolute paths begin with "\" or "/" and start at the root folder of <drive>.
  - Folder and file names cannot contain the following characters: \ / : \* ? " < > |
  - The combination of folder and file name cannot exceed 240 characters.
  - The source file and folder and the destination folder must exist and cannot be marked hidden or system.
  - If the destination file exists, it is overwritten, unless marked as hidden or system.
  - If <drive> is omitted:
    - The path is treated as a relative path and appended to the folder specified by **MMEMory:CDIRectory**.
    - Absolute paths are NOT allowed.

## Mass Memory (MMEMory) and State Storage

The front panel uses the MMEM subsystem, not the MEM subsystem, to save states. If you save a state with the front panel, you can still access it with SCPI. However, a state saved into the MEM subsystem via SCPI using \*SAV cannot be retrieved from the front panel.

For example, configure the instrument as desired and insert a USB drive into the front panel. Then enter the following commands. If you do not have a USB drive change "USB:\" to "INT:\" to use the instrument's internal flash drive instead.

```
MMEMory:CDIRectory "USB:\"  
MMEMory:MDIRerctory "States"  
MMEMory:STORe:STATE "USB:\States\State1"
```

To return to this state at any time:

```
MMEMory:LOAD:STATE "USB:\States\State1"
```

You can also recall a state file from the front panel by pressing **[System]** > **Store/Recall**.

### MMEMory:CATalog[:ALL]? [<folder>]

Returns a list of all files in the current mass storage directory, including internal storage and the USB drive.

Parameter	Typical Return
Any valid folder name; defaults to folder selected by <b>MMEMory:CDIRectory</b>	+1000000000,+327168572, "command.exe,,375808", "MySetup.sta,STAT,8192", "MyWave.csv,ASC,11265"
List all files in the folder MyData on the front panel USB storage device: MMEM:CAT? "USB:\MyData"	

- The catalog takes the following form:

```
<mem_used>,<mem_free>{,<file_listing>"}
```

The instrument returns two numeric values and a string for each file in the folder. The first numeric value indicates the number of bytes of storage used on the drive. The second indicates the number of bytes of storage available. Each <file\_listing> is in the format "<file\_name>,<file\_type>,<file\_size>" (the quotation marks are also returned), where <file\_name> is the name of the file including file extension, if any; <file\_type> is either STAT for STATE (.sta) files, ASC for DATA (.csv) files, FOLD for folders, or null for all other file extensions; <file\_size> is the size of the file in bytes.

- If no files exist, only <mem\_used>,<mem\_free> is returned.
- Because the instrument uses a small amount of space in the flash file system for internal use, the <mem\_used> value will not be zero even if no user files exist on the drive.

## MMEMory:CATalog:DATA:ARbitrary? [<folder>]

Returns a list of all the arbitrary sequence (.seq) files and folders, as well as arbitrary waveform (.arb/.barb) files in a folder.

Parameter	Typical Return
Any valid folder name; defaults to folder selected by <b>MMEMory:CDIRectory</b>	(see below)
The following query lists all arbitrary waveform and sequence files in the BuiltIn directory of internal memory.	
<pre>MMEM:CAT:DATA:ARbitrary? "INT:\BuiltIn"</pre>	
Typical Response: 96256,1019770880,"EXP_RISE.arb,ARB,1868","EXP_FALL.arb,ARB,2064", "SINC.arb,ARB,1897","CARDIAC.arb,ARB,2410","NEG_RAMP.arb,ARB,1908", "HAVERSINE.arb,ARB,374","GAUSSIAN.arb,ARB,587","LORENTZ.arb,ARB,1254", "D_LORENTZ.arb,ARB,1373"	

- The instrument returns two numeric values and a string for each .seq and .arb/.barb file in the selected folder. The first numeric value indicates the number of bytes of storage used on the drive. The second indicates the number of bytes of storage available. Each <file listing> is in the format "<filename>,<file\_type>,<file\_size>" (the quotation marks are also returned), where <filename> is the name of the file including file extension, if any; <file\_type> is FOLD for folders, ARB for arb segments, or SEQUENCE for arb sequence files; <file\_size> is the size of the file in bytes.
- If no .seq, .arb, or .barb files exist, only <mem\_used>,<mem\_free> is returned.
- Because the instrument uses a small amount of space in the flash file system for internal use, the <mem\_used> value will not be zero even if no user files exist on the drive.

## MMEMory:CATalog:STATe? [<folder>]

Lists all state files (.sta file extension) in a folder.

Parameter	Typical Return
Any valid folder name; defaults to folder selected by <b>MMEMory:CDIRectory</b>	+1000000000,+327168572,"MySetup.sta,STAT,8192"
List all state files in MyData folder on front panel USB drive. MMEM:CAT:STAT? "USB:\MyData"	

- Format for returned catalog:

`<mem_used>,<mem_free>{,<file_listing>"}`

- The instrument returns two numeric values and a string for each state file in the selected folder. The first numeric value indicates the number of bytes of storage used on the drive. The second indicates the number of bytes of storage available. Each `<file_listing>` is in the format "`<file_name>,<file_type>,<file_size>`" (the quotes are also returned), where `<file_name>` is the name of the file including file extension, if any; `<file_type>` is STAT for STATE (.sta) files; `<file_size>` is the size of the file in bytes.
- If no state files exist, only `<mem_used>,<mem_free>` is returned.
- Because the instrument uses a small amount of space in the flash file system for internal use, the `<mem_used>` value will not be zero even if no user files exist on the drive.

**MMEMory:CDIRectory <folder>**  
**MMEMory:CDIRectory?**  
**MMEMory:MDIRectory <folder>**  
**MMEMory:RDIRectory <folder>**

MMEMory:CDIRectory selects the default folder for the MMEMory subsystem commands. This folder must exist and is used when folder or file names do not include a drive and folder name.

MMEMory:MDIRectory makes a new directory (folder) on the mass storage medium.

MMEMory:RDIRectory removes a directory (folder) on the mass storage medium.

Parameter	Typical Return
Any directory name, including the mass storage unit specifier, default INT:\	"INT:\"
Make and remove a new directory named "test" on the internal mass memory system: MMEM:MDIR "test" MMEM:RDIR "test"  Return the default folder for MMEMory subsystem commands: MMEM:CDIR?	

- The instrument resets the default folder to the internal flash file system root directory ("INT:\") after \*RST.
- You can only remove an empty folder (no files). Otherwise, the instrument generates a "Directory not empty" error.

**MMEMory:COPY <file1>,<file2>**

Copies <file1> to <file2>. The file names must include any file extension.

Parameter	Typical Return
Both files can be any valid file name	(none)
Copy the state file MyFreqMeas.sta from the root directory to the folder "Backup" on the internal flash file system. MMEM:COPY "INT:\MySetup.sta","INT:\Backup"	

- To copy a file to a file of the same name in a different folder, you can specify just the <drive> and/or <path> for <destination>.

### MMEMory:COpy:SEQuence <source>,<destination>

Copies a sequence from <source> to <destination>. The file names must include any file extension. Use the extension .seq for text format.

Parameter	Typical Return
<source> and <destination> may be any valid sequence file name.	(none)
Copy the sequence file MySequence.seq and all associated segment files specified in the sequence file from internal drive to the folder "Backup" on internal storage. MMEM:COpy:SEQ "INT:\MySequence.seq","INT:\Backup"	

- The format for <source> and <destination> is "[<drive>:]<path><file\_name>", where <drive> can be INTernal or USB, and <path> is a file path.
  - INTernal specifies the internal flash file system. USB specifies a front panel USB storage device.
  - If <drive> is specified, <path> is interpreted as an absolute path. Absolute paths begin with "\" or "/" and start at the root folder of <drive>.
  - If <drive> is omitted, <path> is relative to the folder specified by MMEMory:CDIRectory. Relative paths must not begin with "\" or "/".
  - Folder and file names cannot contain the following characters: \ / : \* ? " < > |
  - The combination of folder and file name cannot exceed 240 characters.
  - The source file and folder and the destination folder must exist and cannot be marked hidden or system.
  - If the destination file exists, it is overwritten, unless marked as hidden or system.
  - To copy a sequence file to a sequence file of the same name in a different folder, you can specify just the <drive> and/or <path> for <destination>.

### MMEMory:DELeTe <file>

Deletes a file. To delete a folder, use MMEMory:RDIRectory.

Parameter	Typical Return
Any valid file name, including file extension.	(none)
Delete the indicated file from the root directory of the internal flash file system: MMEM:DEL "INT:\MySetup.sta"	

- You may also use wildcards with this command. For example, MMEM:DEL "INT:\MYDATA\\*.csv" will erase all of the CSV files in the specified directory.

### MMEMory:DOWNload:DATA <binary\_block>

Downloads data from the host computer to a file in the instrument. The filename must have been previously specified by **MMEMory:DOWNload:FNAME**.

The data in <binary\_block> is written to the select file, and any data previously stored in the file is lost.

Parameter	Typical Return
Any IEEE-488 definite or indefinite block	(none)
Writes the word "Hello" to the file "\\Myfile" on internal storage. MMEM:DOWN:FNAME "INT:\\Myfile" MMEM:DOWN:DATA #15Hello	

### MMEMory:DOWNload:FNAME <filename>

Creates or opens the specified filename prior to writing data to that file with **MMEMory:DOWNload:DATA**.

Parameter	Typical Return
Any valid file name	(none)
Write the word "Hello" to the file "\\Myfile" on the internal flash file system: MMEM:DOWN:FNAME "INT:\\Myfile"MMEM:DOWN:DATA #15Hello	

### MMEMory:LOAD:ALL <filename>

### MMEMory:STORe:ALL <filename>

Loads or saves a complete instrument setup, using a named file on the mass storage.

Parameter	Typical Return
Any valid file name on current mass storage directory	(none)
Store instrument setup to file named "completeSetup.all" on internal storage: MMEM:STOR:ALL "INT:\\completeSetup.all"  Load a complete instrument setup from the file in internal mass memory. MMEM:LOAD:ALL "INT:\\completeSetup.all"	

- These commands allow you to duplicate instrument conditions from some previous time.
- This command loads the current instrument setup (such as is used by **\*SAV** and **\*RCL**).
- Instrument setup files used by these commands contain much more than the state files used by **\*SAV** and **\*RCL**. They also contain stored states and arbitrary waveforms, GPIB and LAN parameters, number format, beep on/off, display options, and help language.
- If the destination file exists, it is overwritten, unless marked as hidden or system.



### MMEMory:LOAD:DATA[1|2] <filename>

Loads the specified arb segment(.arb/.barb) or arb sequence (.seq) file in INTERNAL or USB memory into volatile memory for the specified channel.

Parameter	Typical Return
Any valid file name, as described below.	(none)
Load an arbitrary waveform segment from the internal drive into volatile memory for channel 1 and selects it for use. MMEM:LOAD:DATA "Int:\Builtin\HAVERSINE.arb" FUNC:ARB "Int:\Builtin\HAVERSINE.ARB"	

- If a sequence file (.seq) is specified, all the arbitrary waveforms defined in the file are loaded.
- If the waveform referenced by <filename> has already been loaded, the instrument will generate error number +786, "Specified arb waveform already exists". Deleting an existing waveform requires clearing the waveform non-volatile memory with **DATA:VOLatile:CLEar**.

### MMEMory:LOAD:LIST[1|2] <filename>

### MMEMory:STORe:LIST[1|2] <filename>

Loads or stores a frequency list file (.lst).

Parameter	Typical Return
Any valid file name on the mass memory device	(none)
Store the current frequency list to a LIST file on internal storage: MMEM:STOR:LIST "INT:\FreqList.lst"  Load a LIST file on the internal storage mass memory system (file named FreqList.lst). MMEM:LOAD:LIST "INT:\FreqList.lst"	

- A frequency list controls frequency in **FREQ:MODE LIST**, rapidly changing to the next frequency in the list when a trigger event is received.
- A frequency list file contains a comma-separated sequence of ASCII numbers, with the first number representing the number of frequencies in the list:  
3, 100.000000, 1000.000000, 550.000000
- If the destination file exists, it is overwritten, unless marked as hidden or system.

**MMEMory:LOAD:STATe <filename>**

**MMEMory:STORe:STATe <filename>**

Stores the current instrument state to a state file. The file name optionally includes the folder name and the .sta file extension.

Parameter	Typical Return
Any valid file name on the current directory	(none)
Store the current instrument state to the state file MyFreqMeas.sta in the root directory of the internal flash file system. MMEM:STOR:STAT "INT:\MySetup"	
Load the instrument state from MySetup.sta in the root directory of the internal storage. MMEM:LOAD:STAT "INT:\MySetup.sta"	

**MMEMory:MOVE <file1>,<file2>**

Moves and/or renames <file1> to <file2>. The file names must include the file extension.

Parameter	Typical Return
Both files may be any valid file name	(none)
Move the state file MySetup.sta from the currently selected default directory to the folder "Backup" on the internal flash file system; MMEM:MOVE "MySetup.sta","INT:\Backup"	
Rename the arbitrary waveform arbMonday on the USB drive to the name arbTuesday. MMEM:MOVE "USB:\arbMonday", "USB:\arbTuesday"	

- To simply rename a file, specify the same folder for <file1> and <file2>.
- To move a file to a file of the same name in a different folder, you can specify just the <drive>:<path> for <file2>.

### MMEMory:STORe:DATA[1|2] <filename>

Stores the specified arb segment(.arb/.barb) or arb sequence (.seq) data in the channel specified volatile memory (default, channel 1) in INTERNAL or USB memory.

Parameter	Typical Return
Any valid file name	(none)
Store an arbitrary sequence loaded in volatile memory on channel 1 to the internal drive. MMEM:STOR:DATA "INT:\Sequence1.seq"	

- When you store an arbitrary waveform segment or sequence (MMEMory:STORe:DATA[1|2]), the instrument's current settings (voltage values, sample rate, filter type, and so on) are stored in the segment or sequence file. When you play the file for the first time with FUNCTion:ARBitrary, these settings are loaded and override the instrument's current settings. If you have manually edited a segment or sequence file such that the instrument settings have been removed, the instrument settings will not be changed when you execute FUNCTion:ARBitrary.
- If the destination file exists, it is overwritten, unless marked as hidden or system.
- If an arbitrary waveform sequence file (.seq) is specified, all the arbitrary waveform segment file names associated with the sequence are stored in the file.
- Command will error if the specified arbitrary waveform segment or arbitrary waveform sequence is not found in volatile memory.

### MMEMory:UPLoad? <filename>

Uploads the contents of a file from the instrument to the host computer.

Parameter	Typical Return
Any valid file name	IEEE 488.2 definite-length block
The following command uploads the contents of the state file "Myfile.sta" in the root directory of the internal flash file system to the host computer: MMEM:UPL? "INT:\Myfile.sta"	

## OUTPut Subsystem

The OUTPut subsystem controls the front panel channel output and **Sync** connectors and the rear-panel **Ext Trig** connector:

- OUTPut[1|2] {ON|OFF} - front panel channel output connector state
- OUTPut[1|2]:LOAD {<ohms>|INFinity|MINimum|MAXimum|DEFault} - output termination impedance
- OUTPut[1|2]:MODE {NORMal|GATed} - channel output mode
- OUTPut[1|2]:POLarity {NORMal|INVerted} - output waveform polarity
- OUTPut:SYNC {ON|OFF} - front panel **Sync** connector state

- **OUTPut[1|2]:SYNC:MODE?** - sync signal mode
- **OUTPut[1|2]:SYNC:POLarity {NORMAL|INVERTed}** - sync waveform polarity
- **OUTPut:SYNC:SOURce {CH1|CH2}** - channel used to drive sync signal
- **OUTPut:TRIGger {ON|1|OFF|0}** - rear-panel **Ext Trig** connector state
- **OUTPut:TRIGger:SLOPe {POSitive|NEGative}** - "trigger out" polarity
- **OUTPut:TRIGger:SOURce {CH1|CH2}** - channel for driving output trigger

**OUTPut[1|2] {ON|1|OFF|0}**  
**OUTPut[1|2]?**

Enables or disables the front panel output connector.

Parameter	Typical Return
{ON 1 OFF 0}, default OFF	0 (OFF) or 1 (ON)
Enable output connector for channel 1: OUTP ON	

- When output is enabled, the front panel channel output key is illuminated.
- The **APPLY** commands override current **OUTPut** setting and enable the channel output connector.
- If excessive external voltage is applied to the front panel channel output connector, an error message appears and output is disabled. To re-enable output, remove overload from the output connector and send **OUTPut ON**.
- **OUTPut** changes the state of the channel output connector by switching the output relay, without zeroing output voltage. Therefore, output may glitch for about a millisecond until signal stabilizes. Minimize glitching by first minimizing amplitude (**VOLTage MIN**) and setting offset to 0 (**VOLTage:OFFSet 0**) before changing output state.
- This command also toggles the output impedance between 50  $\Omega$  (ON) and high (>1M $\Omega$ ) impedance (OFF).

**OUTPut[1|2]:LOAD {<ohms>|INFinity|MINimum|MAXimum|DEFault}**  
**OUTPut[1|2]:LOAD? [{MINimum|MAXimum}]**

Sets expected output termination. Should equal the load impedance attached to the output.

Parameter	Typical Return
1 $\Omega$ to 10 k $\Omega$ , default 50 $\Omega$	+5.000000000000000E+02
Set output impedance to 300 $\Omega$ : OUTP:LOAD 300	
Set output impedance to "high impedance": OUTP:LOAD INF	

- The specified value is used for amplitude, offset, and high/low level settings.
- The instrument has a fixed series output impedance of 50  $\Omega$  to the front panel channel connectors. If the actual load impedance differs from the value specified, the displayed amplitude and offset levels will be incorrect. The load impedance setting is simply a convenience to ensure that the displayed voltage matches the expected load.
- If you change the output termination setting, the displayed output amplitude, offset, and high/low levels are adjusted (with no error generated). If the amplitude is 10 Vpp and you change the output termination setting from 50  $\Omega$  to "high impedance" (**OUTPut[1|2]:LOAD INF**), the displayed amplitude doubles to 20 Vpp. Changing from "high impedance" to 50  $\Omega$  halves the displayed amplitude. The output termination setting does not affect the actual output voltage; it only changes the values displayed and queried from the remote interface. Actual output voltage depends on the connected load.
- You cannot specify output amplitude in dBm if output termination is set to high impedance. The units are automatically converted to Vpp. See **VOLT:UNIT** for details.
- You cannot change the output termination setting with voltage limits enabled; the instrument cannot know which output termination settings the voltage limits apply to. To change the output termination setting, disable voltage limits, set the new termination value, adjust voltage limits, and re-enable voltage limits.
- If INF (high impedance) is selected, the query returns 9.9E+37.

**OUTPut[1|2]:MODE {NORMal|GATed}**  
**OUTPut[1|2]:MODE?**

Enables (GATed) or disables (NORMal) gating of the output waveform signal on and off using the trigger input.

Parameter	Typical Return
{NORMal GATed}, default NORMal	GAT or NORM
Enable gated output: OUTP:MODE GAT	

- The effect of gating is independent of waveform phase or timing of any sort. When trigger input is asserted, the output signal is generated. When trigger is not asserted, the waveform continues to be generated internally, but it is not routed to channel output connector.
- Gating does not change channel output termination (does not operate output on/off relay).

**OUTPut[1|2]:POLarity {NORMal|INVerted}**  
**OUTPut[1|2]:POLarity?**

Inverts waveform relative to the offset voltage.

Parameter	Typical Return
{NORMal INVerted}, default NORMal	NORM or INV
Set output polarity to INVerted: OUTP:POL INV	

- **NORMal:** waveform goes in one direction at the beginning of the cycle;
- **INVerted:** waveform goes in other.
- As shown below, the waveform is inverted relative to the offset voltage. The offset voltage remains unchanged when the waveform is inverted.

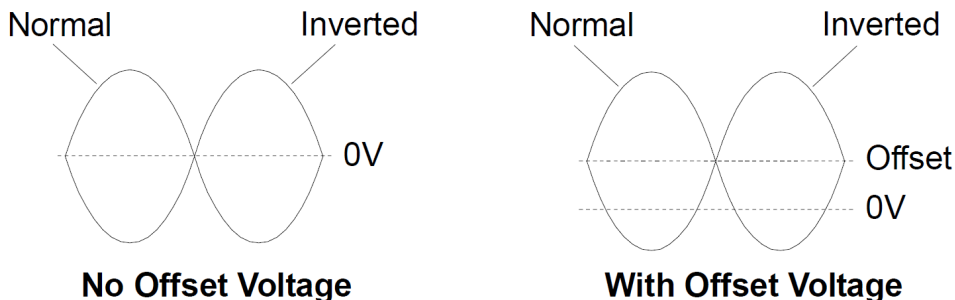

- The **Sync** signal associated with an inverted waveform is not inverted.

**OUTPut:SYNC {ON|1|OFF|0}**

**OUTPut:SYNC?**

Disables or enables the front panel **Sync** connector.

Parameter	Typical Return
{ON 1 OFF 0}, default ON	0 (OFF) or 1 (ON)
Disable front panel <b>Sync</b> connector: OUTP:SYNC OFF	

- Disabling the **Sync** signal reduces output distortion at lower amplitudes.
- For more details on the **Sync** signal for each waveform function, see [Sync Output Signal](#).
- When **Sync** is disabled, the output level on the **Sync** connector is a logic "low."
- Inverting a waveform (**OUTPut[1|2]:POLarity INV**) does not invert the **Sync** signal.

**OUTPut[1|2]:SYNC:MODE {NORMal|CARRier|MARKer}**  
**OUTPut[1|2]:SYNC:MODE?**

Specifies normal **Sync** behavior (NORMal), forces **Sync** to follow the carrier waveform (CARRier), or indicates marker position (MARKer).

Parameter	Typical Return
{NORMal CARRier MARKer}, default NORMal	NORM, CARR, or MARK
Set output sync mode to CARRier: OUTPut:SYNC:MODE CARR	

- The following table details the command's behavior:

<mode>	Sync Behavior	Conditions
NORMal	Sync follows envelope of burst signal.	When BURSt is on
	Sync follows envelope of sweep signal.	When SWEEp is on
	Sync follows modulating signal.	When modulating and modulation source is internal
	Sync follows FUNC signal.	All other conditions
CARRier	Sync follows current SOURce:MARKer:POINT setting.	When BURSt or SWEEp is on and FUNC is ARB
	Sync follows FUNC signal while burst is on.	When BURSt is on and FUNC is not ARB
	Sync follows FUNC signal.	All other conditions
MARKer	Sync follows current SOURce:MARKer:POINT setting.	When in CW mode and FUNC is ARB When modulating, modulation source is internal, and FUNC is ARB or <modulation>:INT:FUNC is ARB When modulating, modulation source is external, and FUNC is ARB
	Sync follows current SOURce:MARKer:CYCLE setting.	When BURST is on
	Sync follows current SOURce:MARKer:FREQuency setting.	When SWEEP is on
	Sync follows modulating signal.	When modulating, modulation source is not external, FUNC is not ARB, and INT:FUNC is not ARB
	Sync follows FUNC signal.	All other conditions



**OUTPut[1|2]:SYNC:POLarity {NORMal|INVerted}**  
**OUTPut[1|2]:SYNC:POLarity?**

Sets the desired output polarity of the **Sync** output to trigger external equipment that may require falling or rising edge triggers.

Parameter	Typical Return
{NORMal INVerted}, default NORMal	NORM or INV
Set the instrument's output sync connector to normal behavior: OUTP:SYNC:POL NORM	

- **NORMal:** voltage on **Sync** output connector is near zero, and rises when a **Sync** event occurs. Voltage stays high (approximately 3.3 V into high impedance) until **Sync** signal is de-asserted, when it falls back to near zero.
- **INVerted:** opposite of NORMal.
- The **Sync** signal may be derived from either channel in a two-channel instrument (**OUTPut:SYNC:SOURce**), and from several operating modes of the **Sync** signal (**OUTPut:SYNC:MODE**).

**OUTPut:SYNC:SOURce {CH1|CH2}**  
**OUTPut:SYNC:SOURce?**

Sets the source for the **Sync** output connector.

Parameter	Typical Return
{CH1 CH2}, default CH1	CH1 or CH2
Set sync source to channel 2: OUTP :SYNC:SOUR CH2	

## OUTPut:TRIGger {ON|1|OFF|0}

### OUTPut:TRIGger?

Disables or enables the "trigger out" signal for sweep and burst modes.

Parameter	Typical Return
{ON 1 OFF 0}, default OFF	0 (OFF) or 1 (ON)
Enable trigger out signal: OUTP:TRIG ON	

- When enabled, a pulse with the specified edge direction (**OUTPut:TRIGger:SLOPe**) is output from the rear-panel **Ext Trig** connector at the beginning of the burst or sweep.
- In triggered burst mode:
  - With **TRIGger[1|2]:SOURce IMMEDIATE**, instrument outputs square wave with 50% duty cycle from the **Ext Trig** connector. The waveform period equals the burst period (**BURSt:INTernal:PERiod**).
  - With **TRIGger[1|2]:SOURce EXTernal** or **BURSt:MODE GAT**, the instrument disables "trigger out." The rear-panel **Ext Trig** connector cannot be used for both operations simultaneously (an externally-triggered waveform uses the same connector to trigger sweep or burst).
  - With **TRIGger[1|2]:SOURce BUS**, the instrument outputs a pulse (>1  $\mu$ s pulse width on the 33500 Series and 100 ns on the 33600 Series) from the **Ext Trig** connector at the beginning of each sweep or burst.
- In frequency sweep mode:
  - With **TRIGger[1|2]:SOURce IMMEDIATE**, the instrument outputs a square wave with a 50% duty cycle (the rising edge is the sweep trigger) from the **Ext Trig** connector. Waveform period equals to the sweep time (**SWEep:TIME**).
  - With **TRIGger[1|2]:SOURce EXTernal**, instrument disables the "trigger out" signal. The rear-panel **Ext Trig** connector cannot be used for both operations simultaneously (an externally-triggered sweep uses the same connector to trigger the sweep).
  - With **TRIGger[1|2]:SOURce BUS**, the instrument outputs a pulse (>1  $\mu$ s pulse width on the 33500 Series and 100 ns on the 33600 Series) from the **Ext Trig** connector at the beginning of each sweep or burst.

## OUTPut:TRIGger:SLOPe {POSitive|NEGative}

### OUTPut:TRIGger:SLOPe?

Selects whether the instrument uses the rising edge or falling edge for the "trigger out" signal.

Parameter	Typical Return
{POSitive NEGative}, default POSitive	POS or NEG
Set trigger slope to NEGative (falling edge): OUTP:TRIG:SLOP NEG	

- POSitive outputs a rising edge pulse; NEGative outputs a falling edge pulse.
- When enabled using OUTPut:TRIGger, a pulse with the specified edge direction is output from the rear-panel **Trig Out** connector at the beginning of a sweep or burst.

## OUTPut:TRIGger:SOURce {CH1|CH2}

### OUTPut:TRIGger:SOURce?

Selects the source channel used by trigger output on a two-channel instrument. The source channel determines what output signal to generate on the trigger out connector.

Parameter	Typical Return
{CH1 CH2}, default CH1	CH1 or CH2
Set output trigger source to CH2: OUTP:TRIG:SOUR CH2	

- In a two-channel instrument, either channel may be source channel for the trigger output, but channel 2 is not valid for dual arbitrary (IQ) waveforms.

## PHASe Subsystem

The PHASe subsystem allows you to adjust the waveform phase; this is useful in channel-to-channel and channel-to-Sync applications. This subsystem also allows you to use the **10 MHz Out** and **10 MHz In** rear-panel connectors to synchronize multiple instruments.

- [SOURce[1|2]:]PHASe {<angle>|MINimum|MAXimum|DEFault} - sets phase offset of output waveform (not available for arbitrary waveforms or noise)
- [SOURce[1|2]:]PHASe:ARBitrary {<angle>|MINimum|MAXimum} - sets the offset for the currently selected arbitrary waveform
- [SOURce[1|2]:]PHASe:MODulation {<angle>|MINimum|MAXimum} - sets the phase of the internal modulation source when modulating by the internal source
- [SOURce[1|2]:]PHASe:REFerence - sets new zero-phase reference point without changing instrument output

- **[SOURce[1|2]:]PHASe:SYNChronize** - synchronizes phase of both internal channels on a two-channel instrument.
- **[SOURce[1|2]:]PHASe:UNLock:ERRor:STATe {ON|1|OFF|0}** - specifies whether instrument generates an error upon losing phase-lock

**[SOURce[1|2]:]PHASe {<angle>|MINimum|MAXimum|DEFault}**

**[SOURce[1|2]:]PHASe? [{MINimum|MAXimum}]**

Sets waveform's phase offset angle.

Parameter	Typical Return
-360 to +360 degrees, $-2\pi$ to $+2\pi$ radians, or $-(\text{period})$ to $+(\text{period})$ , as specified by <b>UNIT:ANGLE</b> . Default 0.	+1.5000000000000E+01
Set channel 1 phase offset to 15 degrees: UNIT:ANGL DEG PHAS 15	

- Phase offset is independent of burst phase (**BURSt:PHASe**).
- This command does not modify channel's primary phase generator; it simply adds phase offset.
- This command also useful for modifying phase relationship between channels in a two-channel instrument and between the channel and its sync signal.
- In a two-channel instrument, use **PHASe:SYNChronize** to synchronize the phases of the two internal channels. Each channel will retain its current phase offset, but the two channels will have a common reference point so the channel-to-channel phase difference will be known.
- When synchronizing the phase of multiple instruments (**ROSC commands**), the phase command allows adjustment of the phase relationship between the instruments.

**[SOURce[1|2]:]PHASe:ARBitrary {<angle>|MINimum|MAXimum}**  
**[SOURce[1|2]:]PHASe:ARBitrary?**

Sets the offset for the currently selected arbitrary waveform in either degrees, radians, seconds or samples. The default units of the <angle> parameter are set by UNIT:ARbitrary:ANGLE.

**NOTE** This command applies only to the 33600 Series and arbitrary waveforms of at least 64 samples.

Parameter	Typical Return
From -360 to 360 (DEGREE) From -2π to 2π (RADIAN) From -arbitrary waveform period to +arbitrary waveform period (SECOND) From -(number of samples-1) to +(number of samples - 1) (SAMPLE)	+3.000000000000000E+01
UNIT:ARB:ANGL DEG PHAS:ARB 30	

- This parameter affects the phase of the currently selected arbitrary waveform only. For other functions, see [SOURce[1|2]:]PHASe.
- This parameter affects the phase of the arbitrary in normal continuous mode, modulation mode, and sweep mode. In burst mode, the arbitrary waveform phase is controlled by [SOURce[1|2]BURSt:PHASe.
- When an arbitrary waveform is loaded into memory, its initial phase is zero; it does not inherit the phase of the currently selected arbitrary waveform. Each arbitrary waveform retains its own phase setting while in memory.
- The phase of the arbitrary waveform is defined with respect to all the points in the arbitrary waveform record. For example, setting the arbitrary phase to 180 degrees on a 64-sample arbitrary waveform will rotate the play of the waveform such that it will begin (as indicated by the sync signal) with the 33<sup>rd</sup> sample and end with the 32<sup>nd</sup>.

**[SOURce[1|2]:]PHASe:MODulation {<angle>|MINimum|MAXimum}**  
**[SOURce[1|2]:]PHASe:MODulation?**

Sets the phase of the internal modulation source when modulating by the internal source with shape SIN, SQU, RAMP, NRAMp, or TRI. This command applies to the 33600 Series only.

**NOTE** This command applies only to the 33600 Series and arbitrary waveforms of at least 64 samples.

Parameter	Typical Return
From -360 to 360 (DEGree) From -2π to 2π (DEGree) From -arbitrary waveform period to +arbitrary waveform period (SECond)	+3.000000000000000E+01
Set the modulation phase to 30 degrees: UNIT:ANGL DEG PHAS:MOD 30	

- The default units of the <angle> parameter are set by UNIT:ANGLE.

**[SOURce[1|2]:]PHASe:REFerence**

Simultaneously removes the offset set by PHASe and adjusts the primary phase generator by an amount equivalent to the PHASe setting. This retains the phase relationship set with another instrument while realigning the sync signal with the output.

Parameter	Typical Return
(none)	(none)
Reset the zero-phase reference point for channel 1: PHAS:REF	

- The primary purpose of this command is to establish a zero-point between two connected instruments. For channel-to-channel operation on a two-channel instrument, use PHASe:SYNChronize.
- Setting a new zero-phase reference point means that the value subsequently returned by a PHASe? query command is reset to "0", but the output waveform itself does not change.

## [SOURce[1|2]:]PHASe:SYNChronize

Simultaneously resets all phase generators in the instrument, including the modulation phase generators, to establish a common, internal phase zero reference point. This command does not affect PHASe setting of either channel; it simply establishes phase difference between channels as the sum of SOUR1:PHAS and SOUR2:PHAS instead of an arbitrary amount.

Parameter	Typical Return
(none)	(none)
Reset all phase generators: PHAS:SYNC	

- SOURce1 and SOURce2 mean nothing for this command.
- This command breaks the phase relation with another instrument, because it resets the phase generators.
- In single channel instruments, this synchronizes the main channel with the internal modulation generator.
- You can synchronize the phase between the primary signal and the SUM signal by sending [SOURce [1|2]:]PHASe:SYNChronize after setting the functions for the primary signal and the SUM signal. Otherwise, the phase between the two signals is arbitrary.

## [SOURce[1|2]:]PHASe:UNLock:ERRor:STATe {ON|1|OFF|0}

### [SOURce[1|2]:]PHASe:UNLock:ERRor:STATe?

Enables or disables the generation of an error if the phase-lock is ever lost by the instrument timebase. The instrument uses one timebase for both channels.

Parameter	Typical Return
{ON 1 OFF 0}, default OFF	0 (OFF) or 1 (ON)
Enable the generation of phase-lock errors: PHASe:UNLock:ERRor:STATe ON	

- SOURce1 and SOURce2 mean nothing for this command.
- If the phase-lock is lost and the error is enabled, a "Reference phase-locked loop is unlocked" error is generated.
- Volatile setting, lost on power cycle.
- A faulty reference signal applied to the **10 MHz In** connector may generate many error messages.

## PM Subsystem

The PM subsystem allows you to phase modulate a waveform.

This summarizes the steps required to generate a phase modulated waveform.

1. **Configure carrier waveform:** Use **FUNCTION**, **FREQUENCY**, **VOLTage**, and **VOLTage:OFFSet** to specify the carrier waveform's function, frequency, amplitude, and offset.
2. **Select modulation source (internal, external, CH1 or CH2):** **PM:SOURce**. For an external modulation source, skip steps 3 and 4.
3. **Set modulating waveform:** **PM:INTernal:FUNctIon**
4. **Set modulating frequency:** **PM:INTernal:FREQuency**
5. **Set phase deviation:** **PM:DEVIation**
6. **Enable PM:** **PM:STATe:ON**

The following code produces the oscilloscope image shown below.

```
FUNCTION SQU
FREQUENCY +1.0E+04
VOLTage +1.0
VOLTage:OFFset 0.0
PM:SOURce INT
PM:DEVIation +90
PM:INTernal:FREQuency +2500
PM:INTernal:FUNctIon RAMP
PM:STATe 1
OUTPut1 1
```

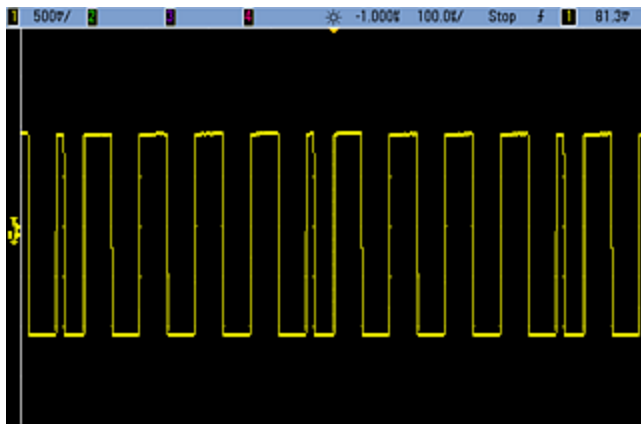



[SOURce[1|2]:]PM:DEVIation {<deviation in degrees>|MINimum|MAXimum|DEFAULT}  
 [SOURce[1|2]:]PM:DEVIation? [{MINimum|MAXimum}]

Sets the phase deviation in degrees. This value represents the peak variation in phase of the modulated waveform from the carrier waveform.

Parameter	Typical Return
0 to 360, default 180	+9.000000000000000E+01
Set phase deviation to ± 90 degrees PM:DEV 90	

- With the External modulating source, deviation is controlled by the ±5 V signal level (optionally ±1 V on the 33600 Series) on the rear-panel **Modulation In** connector. For example, if you have set the frequency deviation to 180 degrees, then a +5 V signal level (optionally ±1 V on the 33600 Series) corresponds to a +180 degree phase deviation. Lower external signal levels produce less deviation, and negative signal levels produce negative deviation.

[SOURCE[1|2]:]PM:INTernal:FREQUENCY {<frequency>|MINimum|MAXimum|DEFAULT}  
 [SOURCE[1|2]:]PM:INTernal:FREQUENCY? [{MINimum|MAXimum}]

Sets the frequency of the modulating waveform. The waveform chosen as the modulating source will operate at that frequency, within the frequency limits of that waveform.

Parameter	Typical Return
1 µHz to the maximum allowed for the internal function. Default 10 Hz.	+1.0000000000000000E-06
Set modulating frequency to 10 kHz: PM:INT:FREQ 10000  Set modulating frequency to 1 µHz: PM:INT:FREQ MIN	

- When you select an arbitrary waveform as the modulating source, the frequency changes to the frequency of the arbitrary waveform, which is based on the sample rate and the number of points in the arbitrary waveform.
- When using an arbitrary waveform for the modulating source, changing this parameter also changes the cached metadata representing the arbitrary waveform's sample rate. You can also change the modulating frequency of an arbitrary waveform with **FUNCTION:ARbitrary:FREQUENCY**, **FUNCTION:ARbitrary:PERiod**, and **FUNCTION:ARbitrary:SRATe**. These commands and the modulation frequency command are directly coupled in order to keep the arbitrary waveform behaving exactly as it was last played. If you later turn modulation off and select that same arbitrary waveform as the current function, its sample rate (and corresponding frequency based upon the number of points) will be the same as it was when played as the modulation source.
- If the internal function is TRIngle, UpRamp, or DnRamp, the maximum frequency is limited to 200 kHz on the 33500 Series or 800 kHz on the 33600 Series. If the internal function is PRBS, the frequency refers to bit rate and is limited **as shown here**.
- This command should be used only with the internal modulation source (**PM:SOURce INTernal**).

[SOURCE[1|2]:]PM:INTernal:FUNCTION <function>  
 [SOURCE[1|2]:]PM:INTernal:FUNCTION?

Selects shape of modulating waveform.

Parameter	Typical Return
{SINusoid SQUare RAMP NRAMP TRIangle NOISe PRBS ARB}, default SINusoid <b>View internal function waveforms.</b>	SIN, SQU, RAMP, NRAM, TRI, NOIS, PRBS, or ARB
Select a sine wave as the modulating waveform: PM:INT:FUNC SIN	

- This command should be used only with the internal modulation source (**PM:SOURce INTernal**).
- You can use noise as the modulating waveform, but you cannot use noise, pulse, or DC as the carrier.

[SOURce[1|2]:]AM:SOURce {INTernal|EXTernal|CH1|CH2}  
[SOURce[1|2]:]AM:SOURce?

[SOURce[1|2]:]BPSK:SOURce {INTernal|EXTernal}  
[SOURce[1|2]:]BPSK:SOURce?

[SOURce[1|2]:]FM:SOURce {INTernal|EXTernal|CH1|CH2}  
[SOURce[1|2]:]FM:SOURce?

[SOURce[1|2]:]FSKey:SOURce {INTernal|EXTernal}  
[SOURce[1|2]:]FSKey:SOURce?

[SOURce[1|2]:]PM:SOURce {INTernal|EXTernal|CH1|CH2}  
[SOURce[1|2]:]PM:SOURce?

[SOURce[1|2]:]PWM:SOURce {INTernal|EXTernal|CH1|CH2}  
[SOURce[1|2]:]PWM:SOURce?

Selects the source of the modulating signal.

Parameter	Typical Return
{INTernal EXTernal CH1 CH2}, default INTernal. BPSK and FSKey cannot accept CH1 or CH2	INT, EXT, CH1, or CH2
Select external modulation source: AM:SOUR EXT (could also substitute FM, BPSK, FSK, PM, or PWM for AM)	

- If you select EXTERNAL, the carrier waveform is modulated with an external waveform. Specifically:
  - **AM:** The modulation depth is controlled by the  $\pm 5$  V signal level (or the optional  $\pm 1$  V signal level on the 33600 Series) on the rear-panel **Modulation In** connector. For example, if modulation depth (**AM[:DEPTH]**) is 100%, then when the modulating signal is at +5 V (or optionally +1 V on the 33600 Series), the output will be at the maximum amplitude. Similarly, a -5 V modulating signal (or optionally -1 V on the 33600 Series) produces output at minimum amplitude.
  - **FM:** If you select the *External* modulating source, the deviation is controlled by the  $\pm 5$  V signal level (optionally  $\pm 1$  V on the 33600 Series) on the rear-panel **Modulation In** connector. For example, if the frequency deviation is 100 kHz, then a +5 V signal level (optionally +1 V on the 33600 Series) corresponds to a 100 kHz increase in frequency. Lower external signal levels produce less deviation and negative signal levels reduce the frequency below the carrier frequency.
  - **PM:** With the External modulating source, deviation is controlled by the  $\pm 5$  V signal level (optionally  $\pm 1$  V on the 33600 Series) on the rear-panel **Modulation In** connector. For example, if you have set the frequency deviation to 180 degrees, then a +5 V signal level (optionally  $\pm 1$  V on the 33600 Series) corresponds to a +180 degree phase deviation. Lower external signal levels produce less deviation, and negative signal levels produce negative deviation.
  - **Pulse as Selected Function:** The pulse width or pulse duty cycle deviation is controlled by the  $\pm 5$  V signal level (optionally  $\pm 1$  V on the 33600 Series) present on the rear-panel **Modulation In** connector. For example, if you have set the pulse width deviation to 50  $\mu$ s using the **PWM:DEVIation** command, then a +5 V signal level (optionally +1 V on the 33600 Series) corresponds to a 50  $\mu$ s width increase. Lower external signal levels produce less deviation.
- With EXTERNAL source, the output phase (BPSK) or frequency (FSK) is determined by the signal level on the rear-panel **Ext Trig** connector. When a logic low is present, the carrier phase or carrier frequency is output. When a logic high is present, the phase shifted phase or hop frequency is output.
- The maximum external BPSK rate is 1 MHz, and the maximum FSK rate is 1 MHz.
- **Note:** the connector used for externally-controlled BPSK or FSK waveforms (**Trig In**) is not the same connector that is used for externally-modulated AM, FM, PM, and PWM waveforms (**Modulation In**). When used for BPSK or FSK, the **Trig In** connector does not have adjustable edge polarity and is not affected by the **TRIGger[1|2]:SLOPe** command.
- With INTERNAL source, the rate at which output phase (BPSK) or frequency (FSKey) "shifts" between the carrier phase or frequency and the alternate phase or frequency is determined by the BPSK rate (**BPSK:INTERNAL:RATE**) or FSK rate (**FSKey:INTERNAL:RATE**).
- A channel may not be its own modulation source.

## See Also

**INPut:ATTenuation[:STATe]**

**AM Subsystem**

**BPSK Subsystem**

**FM Subsystem**

**FSKey Subsystem**

**PM Subsystem**

**PWM Subsystem**

[SOURce[1|2]:]AM:STATe {ON|1|OFF|0}  
[SOURce[1|2]:]AM:STATe?

[SOURce[1|2]:]BPSK:STATe {ON|1|OFF|0}  
[SOURce[1|2]:]BPSK:STATe?

[SOURce[1|2]:]FM:STATe {ON|1|OFF|0}  
[SOURce[1|2]:]FM:STATe?

[SOURce[1|2]:]FSKey:STATe {ON|1|OFF|0}  
[SOURce[1|2]:]FSKey:STATe?

[SOURce[1|2]:]PM:STATe {ON|1|OFF|0}  
[SOURce[1|2]:]PM:STATe?

[SOURce[1|2]:]PWM:STATe {ON|1|OFF|0}  
[SOURce[1|2]:]PWM:STATe?

Enables or disables modulation.

Parameter	Typical Return
{ON 1 OFF 0}, default OFF	0 (OFF) or 1 (ON)
Enable AM (could also substitute FM, BPSK, FSK, PM, or PWM): AM:STAT ON	

- To avoid multiple waveform changes, enable modulation after configuring the other modulation parameters.
- Only one modulation mode may be enabled at a time.
- The instrument will not enable modulation with sweep or burst enabled. When you enable modulation, the sweep or burst mode is turned off.
- PWM is allowed only when pulse is the selected function.

#### See Also

[AM Subsystem](#)  
[PSK Subsystem](#)  
[FM Subsystem](#)  
[FSKey Subsystem](#)  
[PM Subsystem](#)  
[PWM Subsystem](#)

## PWM Subsystem

The PWM subsystem allows you to perform pulse width modulation (PWM) on a pulse waveform.

### Example

This summarizes the steps required to generate a PWM waveform.

1. **Configure a pulse carrier waveform:** Use **FUNCTION**, **FREQUENCY**, **VOLTage**, and **VOLTage:OFFSet** to specify the carrier waveform's function, frequency, amplitude, and offset.
2. **Select modulation source (internal, external, CH1, or CH2):** **PWM:SOURce**. For an external modulation source, skip steps 3 and 4.
3. **Select modulating waveform:** **PWM:INTernal:FUNctIon**
4. **Set modulating frequency:** **PWM:INTernal:FREQuency**
5. **Set pulse width or duty cycle deviation:** **PWM:DEVIation** or **PWM:DEVIation:DCYClE**
6. **Enable PWM:** **PWM:STATe:ON**

The following code produces the oscilloscope image shown below.

```
FUNCTION PULS
FREQUENCY +5000.0
VOLTage +1.0
VOLTage:OFFS +0.0
PWM:DEVIation +5.0E-05
PWM:DEVIation:DCYClE +25.0
PWM:INTernal:FREQuency +1000.0
PWM:INTernal:FUNctIon RAMP
PWM:STATe 1
OUTPut1 1
```

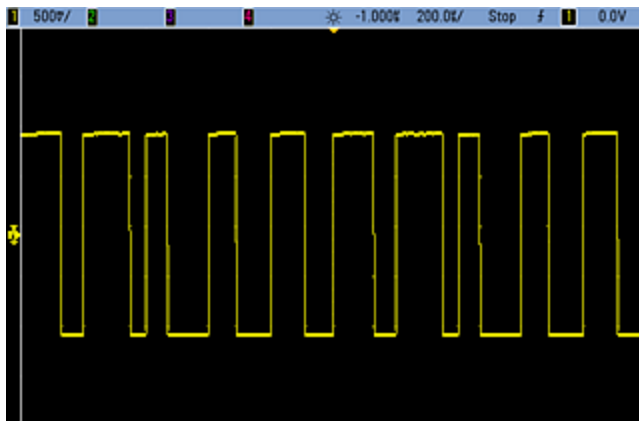

[SOURce[1|2]:]PWM:DEVIation {<deviation>|MINimum|MAXimum|DEFault}  
[SOURce[1|2]:]PWM:DEVIation? [{MINimum|MAXimum}]

Sets pulse width deviation; the ± variation in width (in seconds) from the pulse width of the carrier pulse waveform.

Parameter	Typical Return
0 to 500,000 (seconds); default 10 μs	+1.0000000000000000E+00
Set pulse width deviation to 1 s: PWM:DEV 1	
Set pulse width deviation to 0 s: PWM:DEV MIN	

- The deviation is a ± deviation, so if the pulse width is 10 ms and the deviation is 4 ms, the width can vary from 6 to 14 ms.
- The pulse width deviation cannot exceed the current pulse width, and is also limited by the minimum pulse width (Wmin):

$$\text{Width Deviation} < \text{Pulse Width} - W_{\text{min}}$$

and

$$\text{Width Deviation} < \text{Period} - \text{Pulse Width} - W_{\text{min}}$$

- The pulse width deviation is limited by the current edge time setting.

$$\text{Width Deviation} < \text{Pulse Width} - (0.8 \times \text{Leading Edge Time}) - (0.8 \times \text{Trailing Edge Time})$$

and

$$\text{Width Deviation} < \text{Period} - \text{Pulse Width} - (0.8 \times \text{Leading Edge Time}) - (0.8 \times \text{Trailing Edge Time})$$

- If you select the External modulating source (**PWM:SOURce EXTERNAL**), the deviation is controlled by the ±5 V signal level (optionally ±1 V on the 33600 Series) present on the rear-panel **Modulation In** connector. For example, if you have set the width deviation to 10 μs, then a +5 V signal level (optionally +1 V on the 33600 Series) corresponds to a 10 μs deviation. Lower external signal levels produce less deviation. Negative signal levels produce negative deviation.

[SOURce[1|2]:]PWM:DEVIation:DCYCLE {<deviation\_in\_pct>|MINimum|MAXimum|DEFAULT}  
 [SOURce[1|2]:]PWM:DEVIation:DCYCLE? [{MINimum|MAXimum}]

Sets duty cycle deviation in percent of period. This is the peak variation in duty cycle from the underlying pulse waveform. For example, if duty cycle is 10% and duty cycle deviation is 5%, the duty cycle of the modulated waveform will vary from 5% to 15%.

Parameter	Typical Return
Duty cycle in percent of period, from 0 to 50; default 1	+5.000000000000000E+00
Set pulse width deviation to 5%: PWM:DEV:DCYC 5	

- Duty cycle deviation cannot exceed pulse duty cycle.
- Duty cycle deviation also limited by minimum pulse width (Wmin):

$$\text{Duty Cycle Deviation} < \text{Duty Cycle} - 100 \times \text{Wmin} \div \text{Period}$$

and

$$\text{Duty Cycle Deviation} < 100 - \text{Duty Cycle} - 100 \times \text{Wmin} \div \text{Period}$$

where Wmin = 16 ns on the 33500 Series and 5 ns up to 4 Vpp or 8 ns up to 10 Vpp on the 33600 Series.

- Duty cycle deviation limited by edge time.

$$\text{Duty Cycle Dev} < \text{Duty Cycle} - (80 \times \text{Leading Edge Time}) \div \text{Period} - (80 \times \text{Trailing Edge Time}) \div \text{Period}$$

and

$$\text{Duty Cycle Dev} < 100 - \text{Duty Cycle} - (80 \times \text{Leading Edge Time}) \div \text{Period} - (80 \times \text{Trailing Edge Time}) \div \text{Period}$$

- With **PWM:SOURce EXTERNAL**, deviation is controlled by the ±5 V signal level (optionally ±1 V on the 33600 Series) on rear-panel **Modulation In** connector. For example, with duty cycle deviation of 5 percent, a +5 V signal level (optionally +1 V on the 33600 Series) corresponds to 5% deviation, an additional 5% of period added to the pulse duty cycle. Lower external signal levels produce less deviation, and negative signal levels reduce the duty cycle.



[SOURCE[1|2]:]PWM:INTernal:FREQUENCY {<frequency>|MINimum|MAXimum|DEFAULT}  
 [SOURCE[1|2]:]PWM:INTernal:FREQUENCY? [{MINimum|MAXimum}]

Selects frequency at which output pulse width shifts through its pulse width deviation. The waveform used as the modulating source will operate at that frequency, within frequency limits of that waveform.

Parameter	Typical Return
1 µHz to the <b>maximum allowed for the internal function</b> . Default 10 Hz	+1.0000000000000000E+02
Set internal PWM frequency to 100 Hz: PWM:INT:FREQ 100	

- When you select an arbitrary waveform as the modulating source, the frequency changes to the frequency of the arbitrary waveform, which is based on the sample rate and the number of points in the arbitrary waveform.
- When using an arbitrary waveform for the modulating source, changing this parameter also changes the cached metadata representing the arbitrary waveform's sample rate. You can also change the modulating frequency of an arbitrary waveform with **FUNCTION:ARbitrary:FREQUENCY**, **FUNCTION:ARbitrary:PERiod**, and **FUNCTION:ARbitrary:SRATe**. These commands and the modulation frequency command are directly coupled in order to keep the arbitrary waveform behaving exactly as it was last played. If you later turn modulation off and select that same arbitrary waveform as the current function, its sample rate (and corresponding frequency based upon the number of points) will be the same as it was when played as the modulation source.
- If the internal function is TRiangle, UpRamp, or DnRamp, the maximum frequency is limited to 200 kHz on the 33500 Series or 800 kHz on the 33600 Series. If the internal function is PRBS, the frequency refers to bit rate and is limited **as shown here**.
- This command should be used only with the internal modulation source (**PWM:SOURce INTernal**).

[SOURCE[1|2]:]PWM:INTernal:FUNCTION <function>  
 [SOURCE[1|2]:]PWM:INTernal:FUNCTION?

Selects shape of the internal modulating waveform.

Parameter	Typical Return
{SINusoid SQUare RAMP NRAMP TRIangle NOISe PRBS ARB}, default SINusoid <b>View internal function waveforms.</b>	SIN, SQU, RAMP, NRAM, TRI, NOIS, PRBS, or ARB
Select a sine wave as the modulating waveform shape: PWM:INT:FUNC SIN	

- This command should be used only with the internal modulation source (**PWM:SOURce INTernal**).

[SOURce[1|2]:]AM:SOURce {INTernal|EXTernal|CH1|CH2}  
[SOURce[1|2]:]AM:SOURce?

[SOURce[1|2]:]BPSK:SOURce {INTernal|EXTernal}  
[SOURce[1|2]:]BPSK:SOURce?

[SOURce[1|2]:]FM:SOURce {INTernal|EXTernal|CH1|CH2}  
[SOURce[1|2]:]FM:SOURce?

[SOURce[1|2]:]FSKey:SOURce {INTernal|EXTernal}  
[SOURce[1|2]:]FSKey:SOURce?

[SOURce[1|2]:]PM:SOURce {INTernal|EXTernal|CH1|CH2}  
[SOURce[1|2]:]PM:SOURce?

[SOURce[1|2]:]PWM:SOURce {INTernal|EXTernal|CH1|CH2}  
[SOURce[1|2]:]PWM:SOURce?

Selects the source of the modulating signal.

Parameter	Typical Return
{INTernal EXTernal CH1 CH2}, default INTernal. BPSK and FSKey cannot accept CH1 or CH2	INT, EXT, CH1, or CH2
Select external modulation source: AM:SOUR EXT (could also substitute FM, BPSK, FSK, PM, or PWM for AM)	

- If you select EXTERNAL, the carrier waveform is modulated with an external waveform. Specifically:
  - **AM:** The modulation depth is controlled by the  $\pm 5$  V signal level (or the optional  $\pm 1$  V signal level on the 33600 Series) on the rear-panel **Modulation In** connector. For example, if modulation depth (**AM[:DEPTH]**) is 100%, then when the modulating signal is at +5 V (or optionally +1 V on the 33600 Series), the output will be at the maximum amplitude. Similarly, a -5 V modulating signal (or optionally -1 V on the 33600 Series) produces output at minimum amplitude.
  - **FM:** If you select the *External* modulating source, the deviation is controlled by the  $\pm 5$  V signal level (optionally  $\pm 1$  V on the 33600 Series) on the rear-panel **Modulation In** connector. For example, if the frequency deviation is 100 kHz, then a +5 V signal level (optionally +1 V on the 33600 Series) corresponds to a 100 kHz increase in frequency. Lower external signal levels produce less deviation and negative signal levels reduce the frequency below the carrier frequency.
  - **PM:** With the External modulating source, deviation is controlled by the  $\pm 5$  V signal level (optionally  $\pm 1$  V on the 33600 Series) on the rear-panel **Modulation In** connector. For example, if you have set the frequency deviation to 180 degrees, then a +5 V signal level (optionally  $\pm 1$  V on the 33600 Series) corresponds to a +180 degree phase deviation. Lower external signal levels produce less deviation, and negative signal levels produce negative deviation.
  - **Pulse as Selected Function:** The pulse width or pulse duty cycle deviation is controlled by the  $\pm 5$  V signal level (optionally  $\pm 1$  V on the 33600 Series) present on the rear-panel **Modulation In** connector. For example, if you have set the pulse width deviation to 50  $\mu$ s using the **PWM:DEVIation** command, then a +5 V signal level (optionally +1 V on the 33600 Series) corresponds to a 50  $\mu$ s width increase. Lower external signal levels produce less deviation.
- With EXTERNAL source, the output phase (BPSK) or frequency (FSK) is determined by the signal level on the rear-panel **Ext Trig** connector. When a logic low is present, the carrier phase or carrier frequency is output. When a logic high is present, the phase shifted phase or hop frequency is output.
- The maximum external BPSK rate is 1 MHz, and the maximum FSK rate is 1 MHz.
- **Note:** the connector used for externally-controlled BPSK or FSK waveforms (**Trig In**) is not the same connector that is used for externally-modulated AM, FM, PM, and PWM waveforms (**Modulation In**). When used for BPSK or FSK, the **Trig In** connector does not have adjustable edge polarity and is not affected by the **TRIGger[1|2]:SLOPe** command.
- With INTERNAL source, the rate at which output phase (BPSK) or frequency (FSKey) "shifts" between the carrier phase or frequency and the alternate phase or frequency is determined by the BPSK rate (**BPSK:INTERNAL:RATE**) or FSK rate (**FSKey:INTERNAL:RATE**).
- A channel may not be its own modulation source.

## See Also

**INPut:ATTenuation[:STATe]**

**AM Subsystem**

**BPSK Subsystem**

**FM Subsystem**

**FSKey Subsystem**

**PM Subsystem**

**PWM Subsystem**

[SOURce[1|2]:]AM:STATe {ON|1|OFF|0}  
[SOURce[1|2]:]AM:STATe?

[SOURce[1|2]:]BPSK:STATe {ON|1|OFF|0}  
[SOURce[1|2]:]BPSK:STATe?

[SOURce[1|2]:]FM:STATe {ON|1|OFF|0}  
[SOURce[1|2]:]FM:STATe?

[SOURce[1|2]:]FSKey:STATe {ON|1|OFF|0}  
[SOURce[1|2]:]FSKey:STATe?

[SOURce[1|2]:]PM:STATe {ON|1|OFF|0}  
[SOURce[1|2]:]PM:STATe?

[SOURce[1|2]:]PWM:STATe {ON|1|OFF|0}  
[SOURce[1|2]:]PWM:STATe?

Enables or disables modulation.

Parameter	Typical Return
{ON 1 OFF 0}, default OFF	0 (OFF) or 1 (ON)
Enable AM (could also substitute FM, BPSK, FSK, PM, or PWM): AM:STAT ON	

- To avoid multiple waveform changes, enable modulation after configuring the other modulation parameters.
- Only one modulation mode may be enabled at a time.
- The instrument will not enable modulation with sweep or burst enabled. When you enable modulation, the sweep or burst mode is turned off.
- PWM is allowed only when pulse is the selected function.

#### See Also

[AM Subsystem](#)  
[PSK Subsystem](#)  
[FM Subsystem](#)  
[FSKey Subsystem](#)  
[PM Subsystem](#)  
[PWM Subsystem](#)

## RATE Subsystem

The RATE subsystem allows you to couple the outputs' sample rates on a two-channel instrument by specifying the following items:

- `[SOURCE[1|2]:]RATE:COUPLE[:STATE] {ON|1|OFF|0}`
- `[SOURCE[1|2]:]RATE:COUPLE:MODE {OFFSet|RATio}`
- `[SOURCE[1|2]:]RATE:COUPLE:OFFSet {<sample_rate>|MINimum|MAXimum|DEFAULT}`
- `[SOURCE[1|2]:]RATE:COUPLE:RATio {<ratio>|MINimum|MAXimum}`

`[SOURCE[1|2]:]RATE:COUPLE[:STATE] {ON|1|OFF|0}`  
`[SOURCE[1|2]:]RATE:COUPLE[:STATE]?`

Enables or disables sample rate coupling between channels, or allows one-time copying of one channel's sample rate into the other channel.

Parameter	Typical Return
{ON 1 OFF 0}, default OFF	0 (OFF) or 1 (ON)
Turn on sample rate coupled state: RATE:COUP ON	

- The ON value starts sample rate coupling in the mode specified by `RATE:COUPLE:MODE`.
- If the current offset or ratio, combined with the current sample rate settings, would cause either sample rate to exceed instrument specifications, the instrument will generate an error and the exceeded sample rate will clip at its maximum or minimum value.
- If setting mode to `RATIO` and setting `RATIO` to 1.0 still exceeds the specifications of either channel, an error message will be generated and the `RATE:COUPLE[:STATE]` will not be turned ON.
- Both channels must be configured for `FUNCTION ARB` in order to enable sample rate coupling.

`[SOURCE[1|2]:]RATE:COUPLE:MODE {OFFSet|RATio}`  
`[SOURCE[1|2]:]RATE:COUPLE:MODE?`

Sets type of sample rate coupling to either a constant sample rate offset (`OFFSet`) or a constant ratio (`RATio`) between the channels' sample rates.

Parameter	Typical Return
{OFFSet RATio}, default RATio	OFFS or RAT
Set the sample rate coupling mode to <code>OFFSet</code> . RATE:COUP:MODE OFFSet	

- The default `RATio` is 1.
- The default sample rate coupling is `OFF`.
- The `SOURCE[1|2]` keyword is ignored; the setting applies to both channels.

[SOURce[1|2]:]RATE:COUPle:OFFSet {<sample\_rate>|MINimum|MAXimum|DEFAULT}  
[SOURce[1|2]:]RATE:COUPle:OFFSet?

Sets sample rate offset when a two-channel instrument is in sample rate coupled mode OFFSet.

Parameter	Typical Return
Valid values depend on <b>FUNCTION:ARbitrary:FILTer</b> setting. For <b>NORMAL</b> and <b>STEP</b> , the range is between $\pm 250$ MSa/s (33500 Series) or $\pm 1$ GSa/s (33600 Series). For <b>OFF</b> , the range is between $\pm 62.5$ MSa/s (33500 Series) or $\pm 250$ MSa/s (33600 Series). In any case, default is 0.	+8.000000000000000E+02
Set sample rate offset of channel 2 to 10.3 kSa/s higher than sample rate of channel 1. RATE:COUPle:OFFSet 10300	
Sets the sample rate offset of channel 1 to 45 kSa/s below the sample rate of channel 2. SOUR2:RATE:COUP:OFFS -45000	

- When specifying OFFSet or RATio, the SOURce channel (SOURce1 or SOURce2) is used as the reference channel and the offset or ratio is applied to the other channel. For example, suppose **RATE:COUPle[:STATE]** is ON and **RATE:COUPle:MODE** is OFFSet. Furthermore, suppose channel 1 is operating at 2 kSa/s, and channel 2 is at 10 kSa/s. The command **SOUR1:RATE:COUP:OFFS 2.5** causes Channel 1 to remain at 2 Sa/s, and Channel 2 to be set to 4.5 Sa/s. As one channel's sample rate changes, the other channel's sample rate changes to maintain the specified coupling.
- If the sample rate coupling would cause either channel to exceed sample rate specifications for the present functions, the command will result in an error, and the sample rate will be set to its maximum or minimum limit for the channel.

[SOURce[1|2]:]RATE:COUPle:RATio {<ratio>|MINimum|MAXimum}  
[SOURce[1|2]:]RATE:COUPle:RATio? [{MINimum|MAXimum}]

Sets offset ratio between channel sample rates when a two-channel instrument is in sample rate coupled mode RATio.

Parameter	Typical Return
0.001 to 1000, default 1	+7.500000000000000E-1
Set channel 2's sample rate to twice that of channel 1. SOUR1:RATE:COUP:RATio 2	
Set channel 1's sample rate to 3.14 times that of channel 2. SOUR2:RATE:COUPle:RAT 3.14	

- When specifying OFFSet or RATio, the SOURce channel (SOURce1 or SOURce2) is used as the reference channel and the offset or ratio is applied to the other channel. For example, suppose the instrument is coupled in RATio mode. Furthermore, suppose channel 1 is operating at 2 kSa/s, and channel 2 is at 10 kSa/s. The command **SOUR1:RATE:COUP:RAT 2.5** causes Channel 1 to remain at 2 kSa/s, and Channel 2 to be set to 5 kSa/s. As one channel's sample rate changes, the other channel's sample rate changes to maintain the specified coupling.
- If the sample rate coupling would cause either channel to exceed sample rate specifications for the present functions, the command will result in an error, and the sample rate will be set to its maximum or minimum limit for the channel.

## ROSCillator Subsystem

### WARNING

The external 10 MHz reference input BNC connector, both the shell and center pin, on the rear panel of the instrument is isolated up to  $\pm 42$  Vpk from chassis. The shell of this BNC connector is isolated from the rest of the instrument. Internal circuitry will attempt to keep the isolated voltage to within  $\pm 42$  Vpk to chassis. Attempts to float this input beyond  $\pm 42$  Vpk from chassis may destroy the instrument and cause a hazard that could result in personal injury or death.

### NOTE

The instrument 10 MHz output is chassis referenced.

The ROSCillator subsystem controls use of the 10 MHz reference oscillator and external reference oscillator input. The reference oscillator is the primary clock for all waveform synthesis. All waveforms are phase-locked to the reference oscillator, which therefore controls output signal frequency and phase.

- **ROSCillator:SOURce {INTernal|EXTernal}** - selects internal or external reference oscillator source
- **ROSCillator:SOURce:AUTO {ON|OFF}** - disables or enables automatic selection of reference oscillator signal source
- **ROSCillator:SOURce:CURREnt?** - returns INT or EXT to indicate current reference oscillator source

ROSC:SOURce sets ROSCillator:SOURce:AUTO to OFF, and ROSCillator:SOURce:AUTO ON overrides ROSC:SOURce. The more recent command (of these two) takes priority.

ROSCillator:SOURce INTernal uses the instrument's internal oscillator as the reference oscillator. This may be either standard Temperature Compensated Crystal Oscillator (TCXO) or the **optional Ovenized Crystal Oscillator (OCXO)**.

See **\*OPT?** for details on determining whether OCXO is installed. If an external 10 MHz reference signal is on the rear-panel **10 MHz In** connector, the instrument uses the external signal. An icon also appears at the top right corner of the display to indicate the reference source change.

**ROSCillator:SOURce {INTernal|EXTernal}**  
**ROSCillator:SOURce?**

Selects the source for the reference oscillator used as the frequency/phase reference for signals generated by the instrument.

Parameter	Typical Return
{INTernal EXTernal}, default INT	INT or EXT
Use the external reference oscillator source: ROSC:SOUR EXT	

- **EXTernal:** instrument uses signal on the rear-panel **10 MHz In** connector as reference, and generates an error if this signal is absent or the instrument cannot lock to it. In such error cases, instrument output continues, but the frequency will be unstable.
- **INTernal:** instrument uses the internal reference oscillator and ignores the signal at the **10 MHz In** connector.

**ROSCillator:SOURce:AUTO {ON|OFF}**  
**ROSCillator:SOURce:AUTO?**

Disables or enables automatic selection of the reference oscillator.

Parameter	Typical Return
{ON OFF}, default ON	ON or OFF
Select reference source automatically: ROSC:SOUR:AUTO ON	

- **ON:** the instrument preferentially selects a 10 MHz signal from the rear-panel **10 MHz In** connector.
- **OFF:** the instrument selects the reference oscillator based on the **ROSC:SOURce** setting.



## ROSCillator:SOURce:CURRent?

Indicates which reference oscillator signal is currently in use when **ROSC:SOURce:AUTO** is ON.

Parameter	Typical Return
(none)	INT (internal) or EXT (10 MHz connector on rear panel)
Determine reference signal source: ROSC:SOUR:CURR?	

- INT refers to the basic internal TCXO or the **optional ovenized OCXO oscillator**, whichever is installed.

## SOURce Subsystem

The SOURce keyword is optional in many commands that set parameters for a source or output channel.

### Example

The SOURce keyword and the channel number are optional in the [SOURce[1|2]:]AM[:DEPT]h? query, and if it is omitted, the source defaults to channel 1. The following table shows how various forms of the query are interpreted.

Parameter	Typical Return
AM:DEPT]h?	returns the modulation depth of channel 1
SOUR1:AM:DEPT]h?	returns the modulation depth of channel 1
SOUR2:AM:DEPT]h?	returns the modulation depth of channel 2 (two-channel instruments only)

### Subsystems Using the Optional SOURce Keyword

Because SOURce subsystem commands are often used without the SOURce keyword, these commands are listed by their individual subsystems, below:

AM

APPLy

BPSK

BURSt

DATA

FM

FREQuency

FSKey

FUNCTion

LIST

MARKer

PHASe

PM

PWM

ROSCillator

SUM

SWEp

VOLTage

## Commands Using the Optional SOURce Keyword

The following commands, which are not part of any subsystem, also have the optional SOURce keyword:

COMBine:FEED

TRACK

## STATus Subsystem Introduction

The instrument's SCPI status system records various instrument conditions and states in several register groups.

In this subsystem, an event is something that occurred, even though it may not still be occurring. A condition is something that is currently present. A condition will appear in the event register, but the event register is read destructive; it is cleared (set to 0) when read.

The **STATus commands** manipulate bits in two of the enable registers. You can:

- Enable bits in the **Questionable Data enable** register (**STATus:QUEStionable:ENABle <enable\_value>**). Query: **STATus:QUEStionable:ENABle?**
- Enable bits in the **Operation enable** register (**STATus:OPERation:ENABle <enable\_value>**). Query: **STATus:OPERation:ENABle?**
- Clear all bits in the **Questionable Data** enable register and the Standard Operation enable register (**STATus:PRESet**).

The **STATus queries** accesses information about the status bits in the **Questionable Data** registers, including:

- The binary-weighted sum of all bits enabled in the Questionable Data **condition** register (**STATus:QUEStionable:CONDition?**)
- The binary-weighted sum of all bits enabled in the Questionable Data **event** register (**STATus:QUEStionable[:EVENT]?**)
- The binary-weighted sum of all bits enabled in the Questionable Data **enable** register (**STATus:QUEStionable:ENABle <enable\_value>**).

The **STATus queries** also allow you to access information about the status bits in the **Operation** registers, including:

- The binary-weighted sum of all bits enabled in the Operation **condition** register (**STATus:OPERation:CONDition?**).
- The binary-weighted sum of all bits enabled in the Operation **event** register (**STATus:OPERation[:EVENT]?**).

## Standard Operation Register Group

The following table describes the Standard Operation Register group.

Bit Number	Bit Name	Decimal Value	Definition
<b>0</b>	Calibrating	1	The instrument is performing a calibration.
<b>1</b>	Self-test	2	A self-test is running.
<b>2</b>	(Reserved)	4	(Reserved for future use)
<b>3</b>	Channel 1 Initiated	8	Channel is initiated and outputting the desired waveform. In INIT[1 2]:CONT OFF, this bit is set after receiving an INIT and not cleared until channel goes to IDLE ( trigger count satisfied and not busy.) This bit is 0 if the channel is in INIT[1 2]:CONT ON mode.
<b>4</b>	Channel 2 Initiated	16	
<b>5</b>	Waiting for Trigger, Channel 1	32	Instrument is waiting for a trigger. In INIT [1 2]:CONT OFF, this bit is set after receiving an INIT and while waiting for a trigger. It is cleared after receiving the trigger. This bit is 0 if the channel is in INIT[1 2]:CONT ON mode.
<b>6</b>	Waiting for Trigger, Channel 2	64	
<b>7</b>	(Reserved)	128	(Reserved for future use)
<b>8</b>	Configuration Changed Event	256	This bit is always 0 in the condition register, as it reflects an event, not a condition.
<b>9</b>	(Reserved)	512	(Reserved for future use)
<b>10</b>	Instrument Locked	1024	If a remote interface (USB or LAN) has a lock (SYSTEM:LOCK:REQuest?), this bit will be set. When a remote interface releases the lock (SYSTEM:LOCK:RELease), this bit will be cleared.
<b>11</b>	(Reserved)	2048	(Reserved for future use)
<b>12</b>	(Reserved)	4096	(Reserved for future use)
<b>13</b>	Global Error	8192	This is set if any remote interface has an error in its error queue, and cleared otherwise.
<b>14-15</b>	(Reserved)	16,384 - 32,768	(Reserved for future use)

## Questionable Data Register Group

The following table describes the Questionable Data Register group.

Bit Number	Bit Name	Decimal Value	Definition
<b>0</b>	Channel 1 Voltage Overload	1	Voltage overload on channel 1 output connector. The output has been disabled.
<b>1</b>	Channel 2 Voltage Overload	2	Voltage overload on channel 2 output connector. The output has been disabled.
<b>2</b>	(Reserved)	4	(Reserved for future use)
<b>3</b>	(Reserved)	8	(Reserved for future use)
<b>4</b>	(Reserved)	16	(Reserved for future use)
<b>5</b>	Loop Unlocked	32	Function generator has lost phase lock. Frequency accuracy will be affected.
<b>6</b>	(Reserved)	64	(Reserved for future use)
<b>7</b>	(Reserved)	128	(Reserved for future use)
<b>8</b>	Calibration Error	256	Error occurred during calibration, calibration is unsecured, or calibration memory has been lost
<b>9</b>	External Reference	512	External timebase has been detected.
<b>10-15</b>	(Reserved)	1024 - 32,768	(Reserved for future use)

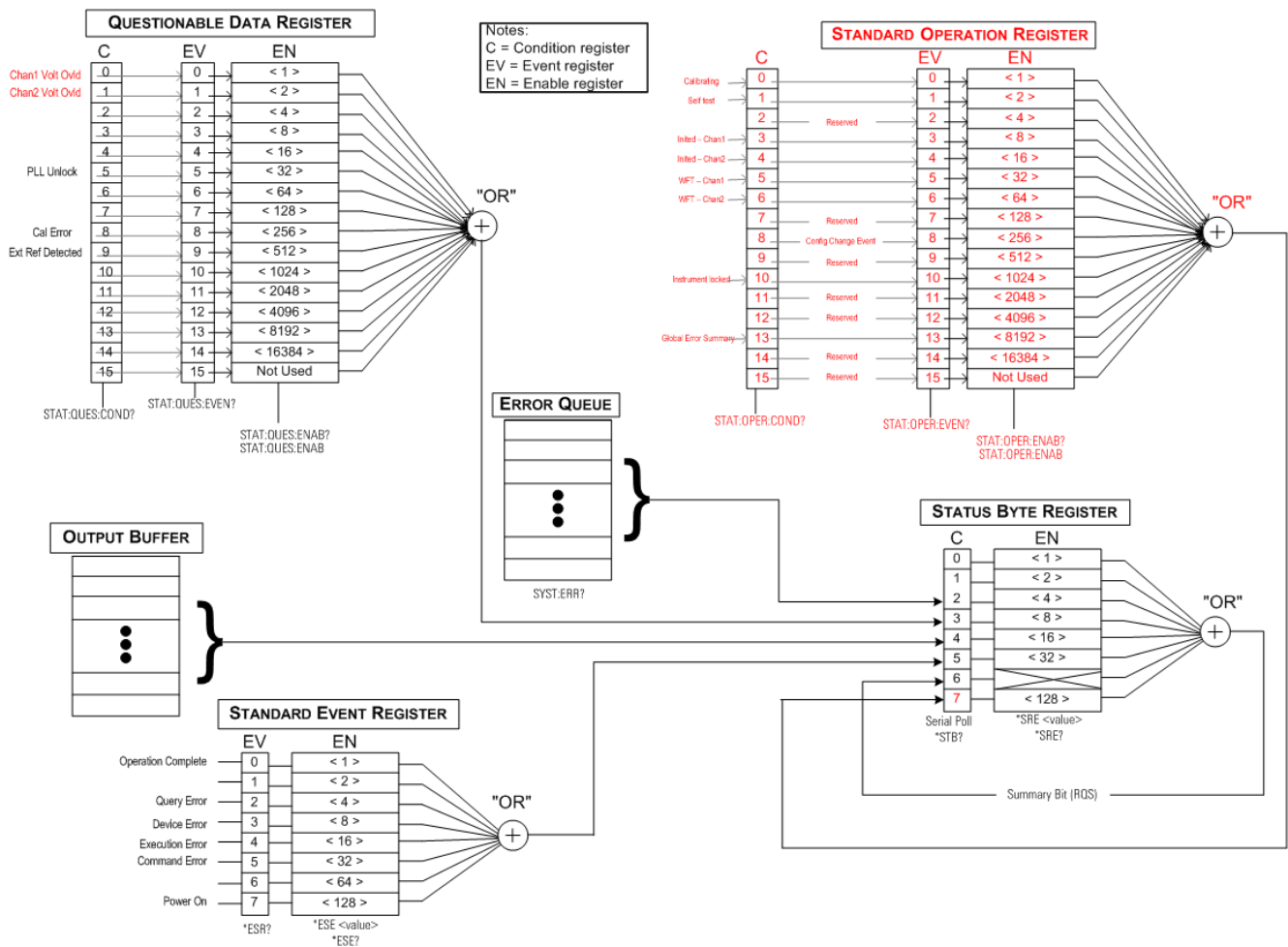

### STATus:OPERation:CONDition?

Queries the condition register for the **Standard Operation Register** group. Register is read-only; bits not cleared when read.

Parameter	Typical Return
(none)	+32
Read the condition register (bit 5 is set): STAT:OPER:COND?	

- The condition register bits reflect the current condition. If a condition goes away, the corresponding bit is cleared.
- **\*RST** clears this register, other than those bits where the condition still exists after **\*RST**.
- The command reads the condition register and returns a decimal value equal to the binary-weighted sum of all bits set in the register. For example, if bit 5 (decimal value = 32) and bit 9 (decimal value = 512) are set, the command will return +544.

## STATus:OPERation:ENABLE <enable\_value>

### STATus:OPERation:ENABLE?

Enables bits in the **enable register** for the **Standard Operation Register** group. The selected bits are then reported to the Status Byte as the standard operation summary bit.

Parameter	Typical Return
Sum of the bits' decimal values in the register.	+256
Enable bit 8 (decimal value 256) in the enable register: STAT:OPER:ENAB 256	

- Use <enable\_value> to specify which bits are reported to the Status Byte. The specified value corresponds to the binary-weighted sum of the register bits to enable. For example, to enable bit 5 (value 32) and bit 9 (value 512), the decimal value would be 544.
- **\*CLS** does not clear the enable register, but does clear the event register.
- This register is cleared at power-on unless **\*PSC** is set to 0.

See Also

**\*STB?**

### STATus:OPERation[:EVENT]?

Queries the event register for the **Standard Operation Register** group. This is a read-only register; the bits are cleared when you read the register.

Parameter	Typical Return
(none)	+32
Read event register: STAT:OPER:EVEN?	

- A set bit remains set until cleared by reading the event register or **\*CLS**.
- **\*RST** does not affect this register.
- Query reads the event register and returns a decimal value equal to the binary-weighted sum of all bits set in the register. For example, if bit 5 (value 32) and bit 9 (value 512) are set, the command returns +544.

### STATus:PRESet

Clears **Questionable Data** enable register and **Standard Operation** enable register.

Parameter	Typical Return
(none)	(none)
Clear enable register bits: STAT:PRES	



## STATus:QUEStionable:CONDition?

Queries the condition register for the **Questionable Data Register group**.

Parameter	Typical Return
(none)	+512
Read the condition register (bit 9 is set): STAT:QUES:COND?	

- The Questionable Data register group provides information about the instrument's quality or integrity.
- Any or all conditions can be reported to the Questionable Data summary bit through the enable register.
- Register is read-only; bits not cleared when read.
- The condition register bits reflect the current condition. If a condition goes away, the corresponding bit is cleared.
- **\*RST** clears the condition register.
- The query reads the condition register and returns a decimal value equal to the binary-weighted sum of all bits set in the register. For example, if bit 12 (decimal value = 4096) is set, the query returns "+4096".

### STATus:QUESTIONable:ENABLE <enable\_value>

#### STATus:QUESTIONable:ENABLE?

Enables bits in the **enable register** for the **Questionable Data Register group**. The selected bits are then reported to the Status Byte.

Parameter	Typical Return
Decimal value equal to the sum of the bit decimal values in the register.	+512
Enable bit 9 (value 512) in the enable register: STAT:QUES:ENAB 512	

- Use <enable\_value> to specify which bits are reported to the Status Byte. The specified value corresponds to the binary-weighted sum of the register bits to enable. For example, to enable bit 5 (value 32) and bit 9 (value 512), the decimal value would be 544.
- Enable register cleared by:
  - STATus:QUESTIONable:ENABLE 0
  - **STATus:PRESet**
  - Power cycle (unless **\*PSC** is set to 0)
- **\*CLS** does not clear enable register but it does clear event register.
- **\*RST** does not affect this register.
- The Query reads the enable register and returns a decimal value equal to the binary-weighted sum of all bits set in the register. For example, if bit 0 (value 1) and bit 1 (value 2) are enabled, the query returns +3.

#### STATus:QUESTIONable[:EVENT]?

Queries the event register for the **Questionable Data Register group**. This is a read-only register; the bits are cleared when you read the register.

Parameter	Typical Return
(none)	+512
Read the event register (bit 9 set): STAT:QUES?	

- Once a bit is set, it remains set until cleared by this query or **\*CLS**.
- **\*RST**, **STATus:PRESet**, and **\*PSC** have no effect on this register.
- Query reads the event register and returns a decimal value equal to the binary-weighted sum of all bits set in the register. For example, if bit 1 (value 2) and bit 9 (value 512) are set, the query returns "+514".

## SUM Subsystem Introduction

The SUM subsystem adds a modulation source signal to a channel's primary signal. This allows you to generate a two-tone signal on one channel, or to add noise to a primary signal. The SUM function uses the **same secondary sources** as used by the modulation subsystems.

Only one modulation or SUM function may be active on a channel at a time, so you cannot add noise to an FM signal using only one channel. For this operation, use **COMBine:FEED**, which combines both channels of a two-channel instrument into one channel output connector.

When signals are SUMmed:

- Their peak amplitude may not exceed the instrument's output rating.
- No other internal or external modulation is possible on that channel.

You can synchronize the phase between the primary signal and the **SUM** signal by sending **[SOURce [1|2]:PHASe:SYNChronize** after setting the functions for the primary signal and the **SUM** signal. Otherwise, the phase between the two signals is arbitrary.

### NOTE

When the source is the other channel, there is a noticeable delay (as much as 350 ns) relative to the carrier even after PHAS:SYNC. Use the Combine feature for the other channel whenever possible.

## Example

To create a SUM waveform:

1. **Configure carrier waveform:** Use **FUNCtion**, **FREQuency**, **VOLTage**, and **VOLTage:OFFSet** to specify the carrier waveform's function, frequency, amplitude, and offset.
2. **Select the summing source:** The instrument accepts an internal or external modulation source (EXT, Channel 1, or Channel 2). Select the modulation source with **SUM:SOURce**. *For an external modulation source, skip steps 3 and 4.*
3. **Configure the summing waveform:** Use **FUNCtion**, **FREQuency**, **VOLTage**, and **VOLTage:OFFSet** commands to configure the summing waveform.
4. **Set the amplitude percentage to sum:** **SUM:AMPLitude**.
5. **Enable SUM Modulation:** **SUM:STATe:ON**.
6. **If using the other channel of a two-channel instrument, synchronize the channels:** **PHASe:SYNChronize**.

The following code produces the oscilloscope image shown below.

```
SOURce1:FUNcTion RAMP
SOURce1:FREQuency +2000.0
SOURce1:VOLTage +1.0
SOURce1:VOLTage:OFFS +0.0
SOURce1:FUNcTion:RAMP:SYMMetry +50.0
SOURce2:FUNcTion SQU
SOURce2:FREQuency +4000.0
SOURce2:VOLTage +1.0
SOURce2:VOLTage:OFFS +0.0
SOURce1:SUM:AMPLitude +50.0
SOURce1:SUM:SOURce CH2
SOURce1:SUM:STATe 1
SOURce1:PHASe:SYNC
OUTPut1 1
OUTPut2 1
```

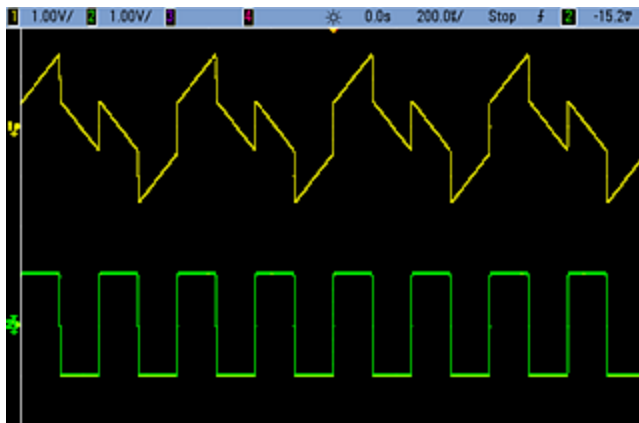

[SOURce[1|2]:]SUM:AMPLitude {<amplitude>|MINimum|MAXimum|DEFault}  
[SOURce[1|2]:]SUM:AMPLitude? [{MINimum|MAXimum}]

Sets internal modulation depth (or "percent modulation") in percent.

Parameter	Typical Return
Desired SUM signal amplitude in percent of carrier amplitude, from 0 to 100; default 0.1	+3.200000000000000E+00
Set the internal SUM signal amplitude to 1.0% of the signal amplitude: SUM:AMPL 1.0 PHAS:SYNC  Set the internal sum signal amplitude on channel 2 to 0.15% of the signal amplitude: SOUR2:SUM:AMPL 0.15	

- You can synchronize the phase between the primary signal and the **SUM** signal by sending [SOURce [1|2]:]PHASe:SYNChronize after setting the functions for the primary signal and the **SUM** signal. Otherwise, the phase between the two signals is arbitrary.
- Summed output cannot exceed ±5 V peak output (into a 50 Ω load).
- If you select the External SUM source (SUM:SOURce EXTERNAL), the carrier waveform is added to the external waveform. The summing signal is the ±5 V signal level (optionally ±1 V on the 33600 Series) on the rear-panel **Modulation In** connector. For example, if you have the carrier amplitude of a sine wave set to 4 Vpp and set the Sum Amplitude to 20% (resulting in a maximum sum contribution of 800 mVpp) using SUM:AMPLitude, then when the EXT signal is at +5 V (optionally +1 V on the 33600 Series), the additive signal output will be at the maximum amplitude of 4.8 Vpp. When the modulating signal is at -5 V (optionally -1 V on the 33600 Series), the additive signal will be at the minimum amplitude of -4.8 Vpp. A modulation input of 0 V would result in a signal equal to the carrier amplitude.

[SOURce[1|2]:]SUM:INTernal:FREQuency {<frequency>|MINimum|MAXimum|DEFault}  
[SOURce[1|2]:]SUM:INTernal:FREQuency? [{MINimum|MAXimum}]

Sets the frequency of the summing waveform when internal sum source is selected (SUM:SOURce:INTernal). The modulating source waveform operates at that frequency, within the frequency limits of that waveform.

Parameter	Typical Return
1 μHz to the maximum allowed for the internal function. Default 100 Hz	+1.0000000000000000E-06
<p>The following command sets the summing frequency to 10 kHz on Channel 2:  SOUR2:SUM:INT:FREQ 10000</p> <p>SOUR2:PHAS:SYNC The following command sets the summing frequency to 1 μHz on Channel 1:  SUM:INT:FREQ MIN  PHAS:SYNC</p>	

- You can synchronize the phase between the primary signal and the **SUM** signal by sending [SOURce[1|2]:]PHASe:SYNChronize after setting the functions for the primary signal and the **SUM** signal. Otherwise, the phase between the two signals is arbitrary.
- When you select an arbitrary waveform as the modulating source, the frequency changes to the frequency of the arbitrary waveform, which is based on the sample rate and the number of points in the arbitrary waveform.
- When using an arbitrary waveform for the modulating source, changing this parameter also changes the cached metadata representing the arbitrary waveform's sample rate. You can also change the modulating frequency of an arbitrary waveform with FUNCTION:ARbitrary:FREQuency, FUNCTION:ARbitrary:PERiod, and FUNCTION:ARbitrary:SRATe. These commands and the modulation frequency command are directly coupled in order to keep the arbitrary waveform behaving exactly as it was last played. If you later turn modulation off and select that same arbitrary waveform as the current function, its sample rate (and corresponding frequency based upon the number of points) will be the same as it was when played as the modulation source.
- If the internal function is TRIngle, UpRamp, or DnRamp, the maximum frequency is limited to 200 kHz on the 33500 Series or 800 kHz on the 33600 Series. If the internal function is PRBS, the frequency refers to bit rate and is limited as shown here.

[SOURce[1|2]:]SUM:INTernal:FUNCTion <function>  
[SOURce[1|2]:]SUM:INTernal:FUNCTion?

Selects the summing waveform (the waveform added to the primary waveform).

Parameter	Typical Return
{SINusoid SQUare RAMP NRAMp TRIangle NOISe PRBS ARB}, default SINusoid	SIN, SQU, RAMP, NRAM, TRI, NOIS, PRBS, or ARB
Select a sine wave as the summing waveform shape for channel 2: SOUR2:SUM:INT:FUNC SIN	

- You can synchronize the phase between the primary signal and the **SUM** signal by sending [SOURce [1|2]:]PHASe:SYNChronize after setting the functions for the primary signal and the **SUM** signal. Otherwise, the phase between the two signals is arbitrary.
- This command is applicable only with internal sum source (SUM:SOURce INTernal).
- You cannot use SUM when DC is the carrier.
- An arbitrary waveform may not simultaneously be a carrier and a sum waveform.

The following table shows which carriers can be associated with which internal functions.

Modulating Signal							
Carrier	Sine	Square	Tri / Ramp	Noise	PRBS	Arb	External
Sine	•	•	•	•	•	•	•
Square/Pulse	•	•	•	•	•	•	•
Ramp/Triangle	•	•	•	•	•	•	•
Gaussian Noise	•	•	•		•	•	•
PRBS	•	•	•	•		•	•
Arbitrary	•	•	•	•	•		•
Sequenced Arbitrary	•	•	•	•	•		•

[SOURCE[1|2]:]SUM:SOURce {INTERNAL|EXTERNAL|CH1|CH2}  
 [SOURCE[1|2]:]SUM:SOURce?

Selects source of summing signal.

Parameter	Typical Return
{INTERNAL EXTERNAL CH1 CH2}, default INTERNAL	INT, EXT, CH1, or CH2
Set the sum source to EXTERNAL: SUM:SOUR EXT	

- You can synchronize the phase between the primary signal and the **SUM** signal by sending [SOURCE[1|2]:]PHASe:SYNChronize after setting the functions for the primary signal and the **SUM** signal. Otherwise, the phase between the two signals is arbitrary.
- SUM:SOURce EXTERNAL**: carrier waveform is summed with external waveform. The amplitude and polarity of the sum signal is determined by the  $\pm 5$  V signal level on the rear-panel **Modulation In** connector (optionally  $\pm 1$  V on the 33600 Series). For example, if you have set the SUM Amplitude to 2.0 Vpp using SUM:AMPLitude, then when EXT signal is at +5 V, the sum signal will be at 2 Vpp. When the modulating signal is at -5 V, the sum signal will be at full amplitude and opposite polarity.

[SOURCE[1|2]:]SUM:STATe {ON|1|OFF|0}  
 [SOURCE[1|2]:]SUM:STATe?

Disables or enables SUM function.

Parameter	Typical Return
{ON 1 OFF 0}, default OFF	0 (OFF) or 1 (ON)
Enable SUM SUM:STAT ON	

- You can synchronize the phase between the primary signal and the **SUM** signal by sending [SOURCE[1|2]:]PHASe:SYNChronize after setting the functions for the primary signal and the **SUM** signal. Otherwise, the phase between the two signals is arbitrary.
- To avoid multiple waveform changes, enable SUM after you have configured the other sum parameters.
- Only one modulation mode may be enabled at a time.
- The instrument will not allow SUM to be enabled when sweep or burst is enabled. When you enable SUM, the sweep or burst mode is turned off.
- With SUM:STATe ON, the sum amplitude plus the carrier amplitude may not exceed either the programmed limits or the instrument's output rating. If setting SUM:STATe ON would cause either the output rating or the limits to be exceeded, SUM:STATe will be set OFF and the instrument will report a settings conflict error.



## SWEEP Subsystem Introduction

To generate a frequency sweep:

1. **Select the waveform shape, amplitude and offset:** Use **APPLY** or the equivalent **FUNCTION**, **FREQUENCY**, **VOLTAGE**, and **VOLTAGE:OFFSET** commands to select the function, frequency, amplitude, and offset. You can select a sine, square, ramp, pulse, or arbitrary waveform (noise, PRBS, and DC are not allowed).
2. **Select sweep's frequency boundaries:** **FREQUENCY:START** and **FREQUENCY:STOP** , or **FREQUENCY:CENTER** and **FREQUENCY:SPAN**
3. **Select linear or logarithmic sweep mode:** **SWEEP:SPACING**
4. **Set sweep time:** **SWEEP:TIME**
5. **Set sweep hold and return times:** **SWEEP:HTIME** and **SWEEP:RTIME**
6. **Select sweep trigger source:** **TRIGGER[1|2]:SOURCE**
7. **Set the marker frequency (optional):** **MARKER:FREQUENCY**
8. **Enable sweep:** **SWEEP:STATE ON**

The following code produces the waveform shown below.

```
SOURCE1:FUNCTION SINE
SOURCE1:FREQUENCY +2.0E+03
SOURCE1:FREQUENCY:START +2.0E+03
SOURCE1:FREQUENCY:STOP +6.0E+03
SOURCE1:VOLTAGE +1.0
SOURCE1:VOLTAGE:OFFS +0.0
SOURCE1:SWEEP:TIME +5.0E-03
TRIGGER1:SOURCE IMM
SOURCE1:FREQUENCY:MODE SWE
OUTPUT1 1
```

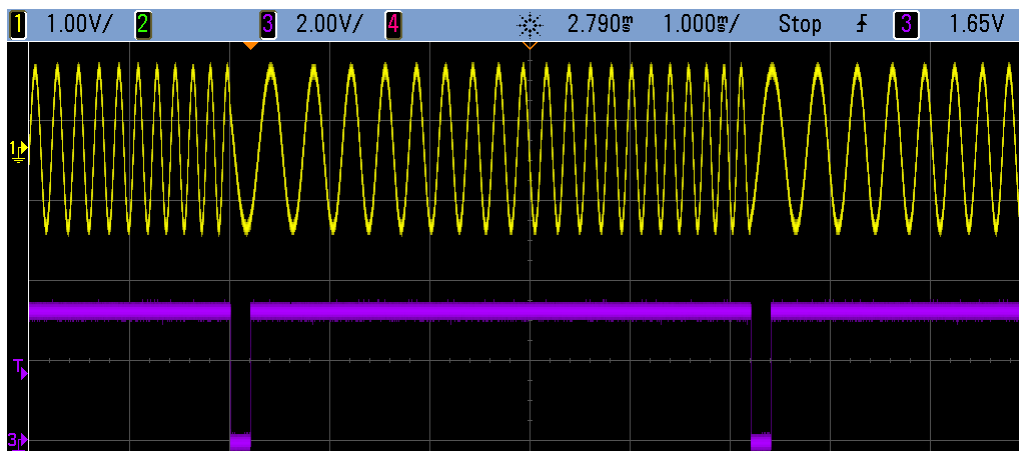

[SOURCE[1|2]:]SWEep:HTIME {<hold\_time>|MINimum|MAXimum|DEFAULT}  
 [SOURCE[1|2]:]SWEep:HTIME? [{MINimum|MAXimum}]

Sets number of seconds the sweep holds (pauses) at the stop frequency before returning to the start frequency.

Parameter	Typical Return
0 to 3600, default 0	+3.4000000000000000E+00
Set sweep hold time to 3.4 seconds: SWE:HTIM 3.4	

[SOURCE[1|2]:]SWEep:RTIME {<return\_time>|MINimum|MAXimum|DEFAULT}  
 [SOURCE[1|2]:]SWEep:RTIME? [{MINimum|MAXimum}]

Sets number of seconds the sweep takes to return from stop frequency to start frequency.

Parameter	Typical Return
0 to 3600, default 0	+5.6000000000000000E+00
Set sweep return time to 5.6 s: SWE:RTIM 5.6	

- The return sweep is always a linear sweep, regardless of the setting of **SWEep:SPACing**.

[SOURCE[1|2]:]SWEep:SPACing {LINear|LOGarithmic}  
 [SOURCE[1|2]:]SWEep:SPACing?

Selects linear or logarithmic spacing for sweep.

Parameter	Typical Return
{LINear LOGarithmic}, default LIN	LIN or LOG
Set logarithmic sweep spacing: SWE:SPAC LIN	

- **LINear**: output frequency varies linearly (from start frequency to stop frequency) during sweep.
- **LOGarithmic**: output frequency varies logarithmically (from start frequency to stop frequency) during sweep.

[SOURCE[1|2]:]SWEep:STATe {ON|1|OFF|0}  
 [SOURCE[1|2]:]SWEep:STATe?

Enables or disables the sweep.

Parameter	Typical Return
{ON 1 OFF 0}, default OFF	0 (OFF) or 1 (ON)
Enable sweep: SWE:STAT ON	

[SOURCE[1|2]:]SWEep:TIME {<seconds>|MINimum|MAXimum|DEFault}  
 [SOURCE[1|2]:]SWEep:TIME? [{MINimum|MAXimum}]

Sets time (seconds) to sweep from start frequency to stop frequency.

Parameter	Typical Return
1 ms to 250,000 s for linear sweep, up to 500 s for logarithmic sweep; default 1 s	+2.5000000000000000E+01
Set sweep time to 25 s: SWE:TIME 25	

- The number of discrete frequency points in the sweep is calculated based on the sweep time.

## SYSTEM Subsystem

The SYSTem subsystem manages instrument state storage, power-down recall, error conditions, self test, front panel display control and remote interface configuration.

### NOTE

The instrument uses LAN port 5024 for SCPI Telnet sessions, and port 5025 for SCPI Socket sessions.

- **SYSTem:BEEPer[:IMMEDIATE]** - issues a single beep
- **SYSTem:BEEPer:STATe {ON|1|OFF|0}** - disables or enables beeper
- **SYSTem:CLICK:STATe** - disables or enables keypress click
- **SYSTem:COMMunicate:ENABLE {ON|1|OFF|0}, <interface>** - disables or enables GPIB, USB, LAN interface, and remote services
- **SYSTem:COMMunicate:GPIB:ADDReSS <address>** - assigns instrument's GPIB (IEEE-488) address
- **SYSTem:DATE <yyyy>, <mm>, <dd>** - sets system clock date
- **SYSTem:ERRor?** - reads and clears one error from error queue

- **SYSTem:LIcense:CATalog?** - lists installed, **licensed options**
- **SYSTem:LIcense:DELeTe "<option\_name>"** - deletes a license
- **SYSTem:LIcense:DELeTe:ALL** - deletes all licenses
- **SYSTem:LIcense:DEScRiption? "<option\_name>"** - returns description of a **licensed option**
- **SYSTem:LIcense:ERRor?** - lists errors generated during license installation
- **SYSTem:LIcense:ERRor:COUnT?** - returns number of errors generated during license installation
- **SYSTem:LIcense:INStAll "<file>"** - installs licenses from a file or folder  
**SYSTem:LIcense:INStAll? "<option>"** - indicates whether a license is installed
- **SYSTem:LOCK:NAME?** - returns current I/O interface
- **SYSTem:LOCK:OWNer?** - returns interface that has the lock
- **SYSTem:LOCK:RELease** - releases lock and decrements lock count by 1
- **SYSTem:LOCK:REQueSt?** - requests lock of current interface
- **SYSTem:SECurity:IMMediate** - sanitizes user-accessible instrument memory
- **SYSTem:TIME <hh>, <mm>, <ss>** - sets system clock time
- **SYSTem:VERsion?** - returns version of SCPI used by instrument

#### **SYSTem:BEEPer[:IMMediate]**

Issues a single beep.

<b>Parameter</b>	<b>Typical Return</b>
(none)	(none)
Issue a single beep: SYST:BEEP	

- Sending a programmed beep may be useful for program development and troubleshooting.
- This command overrides the current beeper state (the SYSTem:BEEPer:STATe ). This means that you can issue a single beep even if the beeper is turned off.

**SYSTem:BEEPer:STATe {ON|1|OFF|0}**  
**SYSTem:BEEPer:STATe?**

Disables or enables the beeper tone heard when an error is generated from the front panel or remote interface.

Parameter	Typical Return
{ON 1 OFF 0}, default ON	0 (OFF) or 1 (ON)
Disable beeper state: SYST:BEEP:STAT OFF	

- Turning off the beeper does not disable the front panel key click.
- A beep is always emitted (even with beep state OFF) when **SYSTem:BEEPer** is sent.
- This setting is non-volatile; it will not be changed by power cycling or **\*RST**.

**SYSTem:CLICk:STATe {ON|1|OFF|0}**  
**SYSTem:CLICk:STATe?**

Disables or enables the click heard when a front panel key or softkey is pressed.

Parameter	Typical Return
{ON 1 OFF 0}, default ON	0 (OFF) or 1 (ON)
Disable keyboard click: SYST:CLIC:STAT OFF	

- This command does not affect the beeper that indicates errors.
- This setting is non-volatile; it is not changed by power cycling or a Factory Reset (**\*RST**).

**SYSTem:COMMunicate:ENABLE {ON|1|OFF|0}, <interface>**

**SYSTem:COMMunicate:ENABLE? <interface>**

Disables or enables the GPIB, USB, or LAN remote interface. Also disables or enables available remote services such as Sockets, Telnet, VXI11, and the built-in Web Interface.

Parameter	Typical Return
{ON 1 OFF 0}, default ON for all interfaces	0 (OFF) or 1 (ON)
{GPIB USB LAN SOCKETs TELNet VXI11 WEB}	
Disable the USB interface: SYST:COMM:ENAB OFF,USB  Returns the state of the USB interface: SYST:COMM:ENAB? USB	

**NOTE**

When you disable or re-enable any interface or LAN service, you must cycle power to activate the new setting.

- If you disable the LAN interface, all associated LAN services will not be started when you power on the instrument.
- This setting is non-volatile; it will not be changed by power cycling or \*RST.
- **SYSTem:SECurity:IMMEDIATE** enables all interfaces.

**SYSTem:COMMunicate:GPIB:ADDRess <address>**

**SYSTem:COMMunicate:GPIB:ADDRess?**

Assigns instrument's GPIB (IEEE-488) address, which is displayed at power-on. Each device on the GPIB interface must have a unique address.

Parameter	Typical Return
0 to 30, default 10	+15
Set GPIB address to 15: SYST:COMM:GPIB:ADDR 15	

- Your computer's GPIB interface card address must not conflict with any instrument on the interface bus.
- This setting is non-volatile; it will not be changed by power cycling or \*RST.
- **SYSTem:SECurity:IMMEDIATE** sets GPIB address to 10.
- Must cycle power for this command to take effect.

**SYSTem:DATE <yyyy>, <mm>, <dd>**  
**SYSTem:DATE?**

Sets system clock date.

Parameter	Typical Return
<yyyy> 2000 to 2100 <mm> 1 to 12 <dd> 1 to 31	+2011,+7,+26
Set system date to July 26, 2011: SYST:DAT 2011,7,26	

**SYSTem:ERRor?**

Reads and clears one error from error queue.

Parameter	Typical Return
(none)	-113,"Undefined header"
Read and clear first error in error queue: SYST:ERR?	

- Up to 20 command syntax or hardware errors can be stored in each interface-specific error queue (one each for GPIB, USB, VXI-11, and Telnet/Sockets.)
- Error retrieval is first-in-first-out (FIFO), and errors are cleared as you read them. The instrument beeps once each time an error is generated (unless disabled by **SYSTem:BEEPer:STATe OFF**).
- If more than 20 errors have occurred, the last error stored in the queue (the most recent error) is replaced with -350,"Error queue overflow". No additional errors are stored until you remove errors from the queue. If no errors have occurred when you read the error queue, the instrument responds with +0,"No error".
- The error queue is cleared by the \*CLS and when power is cycled. It is not cleared by \*RST.
- Errors have the following format (the error string may contain up to 255 characters).

<error code>,<error string>

Where:

<error code> = a three-digit code, sometimes preceded by a dash

<error string> = a quoted ASCII string up to 255 characters

## Licensed Options

The following commands are associated with licensed options. The licensed options are named as shown below.

Option Code	Description
ARB	Arbitrary waveforms
BW30	Increase bandwidth to 30 MHz (33500 Series)
BW120	Increase bandwidth to 120 MHz (33600 Series)
IQP	IQ Player (2-channel instruments only)
MEM	16 MSa Arb Memory (33500 Series) or 64 MSa Arb Memory (33600 Series)
SEC	Enable NISPOM & File Security

### SYSTem:LIcense:CATalog?

Returns a comma separated list of installed, **licensed options**.

Parameter	Typical Return
(none)	"SEC", "IQP", "MEM"
Return currently licensed options: SYST:LIC:CAT?	

- Only those installed options that require a license are returned.

### SYSTem:LIcense:DElete "<option\_name>"

Deletes a license.

**CAUTION**

Exercise caution before executing this command. The only way to undo a license deletion is to re-install the license.

Parameter	Typical Return
{ARB BW30 BW120 IQP MEM SEC}	(none)
Delete license for IQ Player: SYST:LIC:DEL "IQP"	

- Valid option names are double quoted strings representing the installed **licensed options**. They can be easily identified using **SYSTem:LIcense:CATalog?**.



## SYSTem:LiCense:DELeTe:ALL

Deletes all licenses.

### CAUTION

Exercise caution before executing this command. The only way to undo a license deletion is to re-install the license.

Parameter	Typical Return
(none)	(none)
Delete all licenses: SYST:LIC:DEL:ALL	

## SYSTem:LiCense:DESCRiption? "<option\_name>"

Returns a description of specified option, regardless of whether it is currently licensed.

Parameter	Typical Return
See list of <b>licensed options</b>	"Extended Memory Option: 16 MSa/channel waveform memory"
Return description for option 002: SYST:LIC:DESC? "MEM"	

- Option names are quoted strings representing options that may be licensed. Installed licensed items can be identified with **SYSTem:LiCense:CATalog?**.

## SYSTem:LiCense:ERRor?

Returns a string of all the errors produced by **SYSTem:LiCense:INSTall**.

Parameter	Typical Return
(none)	#279File: MyFile.lic<CR><LF>[Ignored - The license file is not formatted correctly.]<CR><LF>
Return the license installation error string: SYST:LIC:ERR?	

- String can be up to 2096 characters.
- Returns a definite-length block containing multi-line ASCII text, including carriage returns and line feeds.

## SYSTem:LiCense:ERRor:COUnT?

Returns the number of license errors generated by **SYSTem:LiCense:INSTall**.

Parameter	Typical Return
(none)	+0
Return number of license errors: SYST:LIC:ERR:COUnT?	

## SYSTem:LiCense:INSTall "<file>"

### SYSTem:LiCense:INSTall? "<option>"

This command installs all licenses from a specified file or from all license files in the specified folder. The query returns 0 or 1 to indicate whether the specified license is installed.

Parameter	Typical Return
<folder> may be any valid folder name. Default is root directory of a front panel USB storage device. <file> may be any valid license file name <option> is one of the <b>licensed options</b>	0 (license not installed) or 1 (license installed)
Install licenses from a file: SYST:LIC:INSTALL "USB:\33522B_LICENSE071.lic"	

- License files must have a ".lic" file extension.
- The format for <file> is "[<drive>:<path>]<file\_name>", where <drive> can be INTernal or USB, and <path> must be an absolute folder path.
  - INTernal specifies the internal flash file system. USB specifies a front panel USB storage device.
  - If <drive>:<path> is omitted, the folder specified by the MMEMory:CDIRectory command is used.
  - Absolute paths begin with "\" or "/" and start at the root folder of <drive>.
  - Folder and file names cannot contain the following characters: \ / : \* ? " < > |
  - The combination of folder and file name cannot exceed 240 characters.
  - The specified folder must exist and cannot be marked hidden or system.

### SYSTem:LOCK:NAME?

Returns the current I/O interface (the I/O interface in use by the querying computer).

Parameter	Typical Return
(none)	"LAN169.254.149.35"
See <a href="#">Interface Locking Examples</a>	

- After using this command to determine the name of the interface that you are using, use SYSTem:LOCK:OWNer? to determine which interface, if any, has the lock.
- Returns "USB", "VXI11", "GPIB", or "LAN <IP Address>" indicating the I/O interface being used by the querying computer.

### SYSTem:LOCK:OWNer?

Returns the I/O interface that currently has a lock.

Parameter	Typical Return
(none)	"LAN169.254.149.35"
See <a href="#">Interface Locking Examples</a>	

- When a lock is active, Bit 10 in the Standard Operation Register will be set (STATus:OPERation:CONDition?). When the lock is released on all I/O interfaces, this bit will be cleared.
- Returns "USB", "VXI11", "GPIB", or "LAN <IP Address>" indicating the I/O interface that currently has a lock. If no interfaces have a lock, "NONE" is returned.

### SYSTem:LOCK:RELease

Decrements the lock count by 1 and may release the I/O interface from which the command is executed.

Parameter	Typical Return
(none)	(none)
See <a href="#">Interface Locking Examples</a>	

- When a lock is active, Bit 10 in the Standard Operation Register will be set (STATus:OPERation:CONDition?). When the lock is released on all I/O interfaces, this bit will be cleared.

## SYSTem:LOCK:REQuest?

Requests a lock of the current I/O interface. This allows you to lock the instrument's configuration or cooperatively share the instrument with other computers.

Parameter	Typical Return
(none)	0 (denied) or 1 (granted)
See <a href="#">Interface Locking Examples</a>	

- Lock requests can be nested; each request increases lock count by 1. For every request, you will need a release ( SYSTem:LOCK:RELease) from the same I/O interface.
- Locks are handled at the I/O interface level (USB, LAN, etc.) and you are responsible for all coordination between threads and/or programs on that interface.
- When a request is granted, only I/O sessions from the present interface will be allowed to change the state of the instrument. You can only query the instrument state from other I/O interfaces.
- LAN sessions locks are automatically released when a LAN disconnect is detected.
- Granting a lock sets Bit 10 in the Standard Operation Register ([STATus:OPERation:CONDition?](#)).

### Interface Locking Examples

The following series of commands illustrates usage.

Initial State = unlocked, Count = 0

```
<FROM USB> SYST:LOCK:REQ? returns 1 (request successful)
```

State = locked, Count = 1

```
<FROM LAN> SYST:LOCK:REQ? returns 0 because USB has lock
```

State = locked, Count = 1

```
<FROM USB> SYST:LOCK:REQ? returns 1 (request successful)
```

State = locked, Count = 2

```
<FROM USB> SYST:LOCK:REL
```

State = locked, Count = 1

```
<FROM USB> SYST:LOCK:REL
```

State = unlocked, Count = 0

Note that for each successful lock request, a lock release is required. Two requests require two releases.

## SYSTem:SECurity:IMMEDIATE

Sanitizes all user-accessible instrument memory. This command complies with requirements in chapter 8 of the National Instrument Security Program Operating Manual (NISPOM).

Parameter	Typical Return
(none)	(none)
Sanitize all user-accessible instrument memory: SYST:SEC:IMM	

### CAUTION

This command is recommended for customers, such as military contractors, who must comply with NISPOM. Excessive use of this command may cause premature failure of the flash memory.

This command destroys all user-defined state information, user-defined arbitrary waveforms, and user-defined I/O settings such as the IP address.

- Typically used before removing an instrument from a secure area.
- Initializes all instrument settings to their Factory Reset (\*RST) values.

SYSTem:TIME <hh>, <mm>, <ss>

SYSTem:TIME?

Sets system clock time.

Parameter	Typical Return
<hh> 0 to 23 <mm> 0 to 59 <ss> 0 to 60	20,15,30.000
Set system Time to 20:15:30 (8:15:30 PM) SYST:TIM 20,15,30	

- This time is used for file timestamps in the Mass Memory (MMEMory) system.

SYSTem:VERSion?

Returns version of the SCPI (Standard Commands for Programmable Instruments) that the instrument complies with. Cannot be determined from front panel.

Parameter	Typical Return
(none)	1994.0
Return the SCPI version: SYST:VERS?	

## LAN Configuration

Configures instrument for remote operation via the local area network (LAN).

**NOTE**

The instrument uses LAN port 5024 for SCPI Telnet sessions, and port 5025 for SCPI Socket sessions.

**Dot Notation Details**

Dot-notation addresses ("nnn.nnn.nnn.nnn" where "nnn" is a byte value from 0 to 255) must be expressed with care, as most PC web software interprets byte values with leading zeros as octal (base 8) numbers. For example, "192.168.020.011" is actually equivalent to decimal "192.168.16.9" because ".020" is interpreted as "16" expressed in octal, and ".011" as "9". To avoid confusion, use only decimal values from 0 to 255, with no leading zeros.

**SYSTem:COMMunicate:LAN:CONTRol?**

Reads the initial Control connection port number for Sockets communications. This connection is used to send and receive commands and queries.

Parameter	Typical Return
(none)	5000 (0 if the interface does not support sockets)
Return the Control connection port number: SYST:COMM:LAN:CONT?	

- Use the Control socket connection to send a Device Clear to the instrument or to detect pending Service Request (SRQ) events. The Device Clear command is "DCL".

**SYSTem:COMMunicate:LAN:DHCP {ON|1|OFF|0}**  
**SYSTem:COMMunicate:LAN:DHCP?**

Disables or enables instrument's use of DHCP. The acronym DHCP stands for Dynamic Host Configuration Protocol, a protocol for assigning dynamic IP addresses to networked devices. With dynamic addressing, a device can have a different IP address every time it connects to the network.

**ON:** instrument tries to obtain an IP address from a DHCP server. If a DHCP server is found, it assigns a dynamic IP address, Subnet Mask, and Default Gateway to the instrument.

**OFF or DHCP unavailable:** instrument uses the static IP address, Subnet Mask, and Default Gateway during power-on.

**NOTE**

If you change this setting, you must send **SYSTem:COMMunicate:LAN:UPDate** to activate the new setting.

Parameter	Typical Return
{ON 1 OFF 0}, default ON	0 (OFF) or 1 (ON)
Disable DHCP: SYST:COMM:LAN:DHCP OFF SYST:COMM:LAN:UPDate	

- Most corporate LANs have a DHCP server.
- If DHCP LAN address not assigned by DHCP server, static IP is assumed after approximately two minutes.
- This setting is non-volatile; it will not be changed by power cycling or **\*RST**.
- Enabled when the instrument is shipped from the factory or after **SYSTem:SECurity:IMMEDIATE**.

**SYSTem:COMMunicate:LAN:DNS[1|2] "<address>"**  
**SYSTem:COMMunicate:LAN:DNS[1|2]? [{CURRENT|STATIC}]**

Assigns static IP addresses of Domain Name System (DNS) servers. A primary and a secondary server address may be assigned. Contact your LAN administrator for details. If DHCP is available and enabled, DHCP will auto-assign the DNS server addresses. These auto-assigned DNS server addresses take precedence over the static DNS addresses assigned with this command.

**NOTE** If you change this setting, you must send **SYSTem:COMMunicate:LAN:UPDate** to activate the new setting.

Parameter	Typical Return
Command: " <b>nnn.nnn.nnn.nnn</b> ", default "0.0.0.0" Query: {CURRENT STATIC}, default CURRENT	"198.105.232.4"
Set a static primary DNS address: SYST:COMM:LAN:DNS "198.105.232.4" SYST:COMM:LAN:UPD	

- CURRENT: read address currently being used by the instrument.
- STATIC: read static address from non-volatile memory. This address is used if DHCP is disabled or unavailable.
- This setting is non-volatile; it will not be changed by power cycling or \*RST.
- Set to "0.0.0.0" by SYSTem:SECurity:IMMEDIATE.

**SYSTem:COMMunicate:LAN:DOMain?**

Returns the domain name of the LAN to which the instrument is connected.

Parameter	Typical Return
(none)	"example.com"
Return domain name being used by instrument: SYST:COMM:LAN:DOM?	

- If Dynamic domain name System (DNS) is available on your network and your instrument uses DHCP, the domain name is registered with the Dynamic DNS service at power-on.
- A null string ("") indicates that no domain name is assigned.



**SYSTem:COMMunicate:LAN:GATeway "<address>"**  
**SYSTem:COMMunicate:LAN:GATeway? [{CURRENT|STATIC}]**

Assigns a default gateway for the instrument. The specified IP Address sets the default gateway which allows the instrument to communicate with systems that are not on the local subnet. Thus, this is the default gateway where packets are sent which are destined for a device not on the local subnet, as determined by the Subnet Mask setting. If DHCP is enabled (SYSTem:COMMunicate:LAN:DHCP ), the specified default gateway is not used. However, if the DHCP server fails to assign a valid IP address, the currently configured default gateway will be used. Contact your LAN administrator for details.

**NOTE**

If you change this setting, you must send **SYSTem:COMMunicate:LAN:UPDate** to activate the new setting.

Parameter	Typical Return
Command: "nnn.nnn.nnn.nnn", default "0.0.0.0" Query: {CURRENT STATIC}, default CURRENT	"198.105.232.1"
Set default gateway address: SYST:COMM:LAN:GATEWAY "198.105.232.1" SYST:COMM:LAN:UPD	

- **CURRENT**: read address currently being used by the instrument.
- **STATIC**: read static address from non-volatile memory. This address is used if DHCP is disabled or unavailable.
- Set to "0.0.0.0" when instrument is shipped from factory or after SYSTem:SECurity:IMMEDIATE.

**SYSTem:COMMunicate:LAN:HOSTname "<name>"**  
**SYSTem:COMMunicate:LAN:HOSTname? [{CURRENT|STATIC}]**

Assigns a hostname to the instrument. A hostname is the host portion of the domain name, which is translated into an IP address. If Dynamic Domain Name System (DNS) is available on your network and your instrument uses DHCP, the hostname is registered with the Dynamic DNS service at power-on. If DHCP is enabled (SYSTem:COMMunicate:LAN:DHCP ), the DHCP server can change the specified hostname.

**NOTE** If you change this setting, you must send **SYSTem:COMMunicate:LAN:UPDate** to activate the new setting.

Parameter	Typical Return
String of up to 15 characters. Must start with letter (A-Z) May contain letters, numbers (0-9), or dashes ("-")	"LAB1-33522A"
Define a hostname: SYST:COMM:LAN:HOST "LAB1" SYST:COMM:LAN:UPD	

- Set to "A-33521A-nnnnn" or "A-33522A-nnnnn", where nnnnn is the last five digits of the instrument's serial number, when the instrument is shipped from the factory or after **SYSTem:SECurity:IMMEDIATE**.
- If no hostname exists, a null string ( "" ) is returned.

**SYSTem:COMMunicate:LAN:IPADdress "<address>"**  
**SYSTem:COMMunicate:LAN:IPADdress? [{CURRENT|STATIC}]**

Assigns a static Internet Protocol (IP) address for the instrument. If DHCP is enabled (SYSTem:COMMunicate:LAN:DHCP), the specified static IP address is not used. Contact your LAN administrator for details.

**NOTE** If you change this setting, you must send **SYSTem:COMMunicate:LAN:UPDate** to activate the new setting.

Parameter	Typical Return
Command: " <b>nnn.nnn.nnn.nnn</b> ", default "0.0.0.0" Query: {CURRENT STATIC}, default CURRENT	"169.254.149.35"
Set a static IP address: SYST:COMM:LAN:IPAD "169.254.149.35" SYST:COMM:LAN:UPD	

- CURRENT: read address currently being used by the instrument.
- STATIC: read static address from non-volatile memory. This address is used if DHCP is disabled or unavailable.
- This setting is non-volatile; it will not be changed by power cycling or \*RST.
- Set to "169.254.5.21" when the instrument is shipped from the factory or after **SYSTem:SECurity:IMMEDIATE**.

**SYSTem:COMMunicate:LAN:MAC?**

Reads the instrument's Media Access Control (MAC) address.

**NOTE** Your LAN administrator may need the MAC address to assign a static IP address for this device.

Parameter	Typical Return
(none)	"0030D3001041"
Return the MAC address: SYST:COMM:LAN:MAC?	

- The MAC address is also known as the link-layer address, the Ethernet (station) address, LANIC ID, or Hardware Address. This is an unchangeable 48-bit address assigned by the manufacturer to each unique Internet device.
- The instrument's MAC address is set at the factory and cannot be changed.
- This setting is non-volatile; it will not be changed by power cycling or \*RST.

**SYSTem:COMMunicate:LAN:SMASK "<mask>"**  
**SYSTem:COMMunicate:LAN:SMASK? [{CURRENT|STATIC}]**

Assigns a subnet mask for the instrument. The instrument uses the subnet mask to determine whether a client IP address is on the same local subnet. When a client IP address is on a different subnet, all packets must be sent to the Default Gateway. Contact your LAN administrator for details.

**NOTE** If you change this setting, you must send **SYSTem:COMMunicate:LAN:UPDate** to activate the new setting.

Parameter	Typical Return
Command: "nnn.nnn.nnn.nnn", default "0.0.0.0" Query: {CURRENT STATIC}, default CURRENT	"255.255.0.0"
Set the subnet mask: SYST:COMM:LAN:SMAS "255.255.255.0" SYST:COMM:LAN:UPD	

- If DHCP is enabled (SYSTem:COMMunicate:LAN:DHCP ), the specified subnet mask is not used. However, if the DHCP server fails to assign a valid IP address, the instrument uses the AutoIP subnet mask.
- A value of "0.0.0.0" or "255.255.255.255" indicates that subnetting is not being used.
- This setting is non-volatile; it will not be changed by power cycling or \*RST.
- The subnet mask is set to "255.255.0.0" when the instrument is shipped from the factory or after a SYSTem:SECurity:IMMEDIATE command.
- CURRENT: read address currently being used by the instrument.
- STATIC: read static address from non-volatile memory. This address is used if DHCP is disabled or unavailable.

SYSTem:COMMunicate:LAN:TELNet:PROMpt "<string>"  
SYSTem:COMMunicate:LAN:TELNet:PROMpt?

Sets the command prompt seen when communicating with the instrument via Telnet.

Parameter	Typical Return
String of up to 15 characters	"Command>"
Set the command prompt: SYST:COMM:LAN:TELN:PROM "Command>"	

- A Telnet session is typically started from a host computer shell:

```
telnet <IP_address> <port>
```

For example: telnet 169.254.4.10 5024

To exit a Telnet session, press <Ctrl-D>.

- This setting is non-volatile; it will not be changed by power cycling or \*RST.
- This is set to "33521A> " (model 33521A), "33522A> " (model 33522A), "33500> " (other 33500 Series models), or "33600> " (33600 Series models) when the instrument is shipped from the factory or after **SYSTem:SECurity:IMMediate**.

SYSTem:COMMunicate:LAN:TELNet:WMESsage "<string>"  
SYSTem:COMMunicate:LAN:TELNet:WMESsage?

Sets welcome message seen when communicating with instrument via Telnet.

Parameter	Typical Return
String of up to 63 characters	"Welcome to the Telnet Session"
Define a welcome message: SYST:COMM:LAN:TELN:WMES "Welcome to the Telnet Session"	

- This setting is non-volatile; it will not be changed by power cycling or \*RST.
- This is set to "Welcome to Keysight's 33521A Waveform Generator" (model 33521A), "Welcome to Keysight's 33522A Waveform Generator" (model 33522A), "Welcome to Keysight's 33500-Series Waveform Generator" (other 33500 Series models), or "Welcome to Keysight's 33600-Series Waveform Generator" (33600 Series models) when the instrument is shipped from the factory or after **SYSTem:SECurity:IMMediate**.

### SYSTem:COMMunicate:LAN:UPDate

Stores any changes made to the LAN settings into non-volatile memory and restarts the LAN driver with the updated settings.

Parameter	Typical Return
(none)	(none)
(see below)	

- This command must be sent after changing the settings for DHCP, DNS, gateway, hostname, IP address, subnet mask, WINS.
- Make all changes to the LAN settings before sending this command.

#### Example

The following example configures the instrument to use statically assigned LAN settings.

```
SYST:COMM:LAN:DHCP OFF
SYST:COMM:LAN:DNS "198.105.232.4"
SYST:COMM:LAN:DNS2 "198.105.232.5"
SYST:COMM:LAN:GATEWAY "198.105.232.1"
SYST:COMM:LAN:HOST "LAB1-33522A"
SYST:COMM:LAN:IPAD "198.105.232.101"
SYST:COMM:LAN:SMAS "255.255.255.0"
SYST:COMM:LAN:WINS "198.105.232.4"
SYST:COMM:LAN:WINS "198.105.232.5"
SYST:COMM:LAN:UPD
```

The following example configures the instrument back to use DHCP.

```
SYST:COMM:LAN:DHCP ON
SYST:COMM:LAN:UPD
```

**SYSTem:COMMunicate:LAN:WINS[1|2] "<address>"**  
**SYSTem:COMMunicate:LAN:WINS[1|2]? [{CURRENT|STATIC}]**

Assigns the static IP addresses of the Windows Internet Name System (WINS) servers. A primary and a secondary server address may be assigned. Contact your LAN administrator for details. If DHCP is available and enabled, DHCP will auto-assign the WINS server addresses. These auto-assigned WINS server addresses take precedence over the static WINS addresses assigned with this command.

**NOTE** If you change this setting, you must send **SYSTem:COMMunicate:LAN:UPDate** to activate the new setting.

Parameter	Typical Return
Command: " <b>nnn.nnn.nnn.nnn</b> ", default "0.0.0.0" Query: {CURRENT STATIC}, default CURRENT	"198.105.232.4"
Set a static primary WINS address: SYST:COMM:LAN:WINS "198.105.232.4" SYST:COMM:LAN:UPD	

- The assigned WINS addresses are used if DHCP is disabled or unavailable. Otherwise, the WINS server addresses are auto-assigned by DHCP.
- This setting is non-volatile; it will not be changed by power cycling or **\*RST**.
- Set to "0.0.0.0" (no servers) after SYSTem:SECurity:IMMEDIATE.
- CURRENT: read address currently being used by the instrument.
- STATIC: read static address from non-volatile memory. This address is used if DHCP is disabled or unavailable.

[SOURce[1|2]:]TRACK {ON|OFF|INVerted}  
TRACK?

Causes channels 1 and 2 of a two-channel instrument to output the same signal, or an inverted polarity signal.

Parameter	Typical Return
{ON OFF INVerted}	ON, OFF, or INV
Set channel 2 to output a signal identical to that of channel 1: TRACK ON	

- Causes all settings of the named channel to be copied to the other channel with exceptions noted below. This does include frequency list settings and any arbitrary waveforms loaded in memory.
- With the INVerted option, the tracking channel's amplitude will be inverted, forming a signal similar to a differential output between Channel 1 and Channel 2. DC Offset is not inverted.
- When TRACK is ON, voltage limits on both channels apply. If voltage limits on either channel would prevent the other channel's setup from being applied, the instrument will generate a settings conflict error and channel tracking will remain OFF.
- When TRACK is ON, changes to either channel are reflected in both channels. When TRACK is changed from ON or INV to OFF, the channels will remain in their present setup (frequency, amplitude, and so on), but you may now change one channel without affecting the other channel.
- Voltage limits may be adjusted in tracking mode, but cannot be set in violation of the current signal.
- Turning tracking ON sets **COMBine:FEED** to NONE, turns off **FREQUency:COUPle**, **VOLTage:COUPle**, and **RATE:COUPle**.
- TRACK is not allowed if the internal modulation source for the channel being tracked is the other channel.
- The **OUTPut:SYNC:SOURce** is set to the channel being tracked.





## TRIGger Subsystem Introduction

### NOTE

The rear-panel external trigger BNC connector is chassis referenced.

Configures triggering for sequence, list, burst, and sweep:

**TRIGger[1|2]** - immediate trigger

**TRIGger[1|2]:COUNT** {<number>MINimum|MAXimum|DEFAULT} - trigger count

**TRIGger[1|2]:DELAY** {<seconds>|MINimum|MAXimum} - trigger delay

**TRIGger[1|2]:LEVEL** {<level>|MINimum|MAXimum} - trigger level

**TRIGger[1|2]:SLOPe** {POSitive|NEGative} - slope of trigger signal at the rear-panel **Ext Trig** connector

**TRIGger[1|2]:SOURCE** {IMMEDIATE|EXTERNAL|TIMER|BUS} - source (internal, external, timer, or bus) from which instrument accepts trigger

**TRIGger[1|2]:TIMER** {<seconds>|MINimum|MAXimum} - timer used when **TRIGger[1|2]:SOURCE** is TIMER.

### TRIGger[1|2]

Forces immediate trigger to initiate sequence, sweep, list, or burst.

Parameter	Typical Return
(none)	(none)
Send an immediate trigger on channel 2: TRIG	

- Can be used with IMMEDIATE, EXTERNAL, TIMER, or BUS trigger source (**TRIGger[1|2]:SOURCE**). For example, you can use TRIGger to issue an immediate trigger while waiting for an external trigger.
- Intended as an override. For general, software controlled triggering, use **\*TRG**.

**TRIGger[1|2]:COUNT** {<number>MINimum|MAXimum|DEFAULT}

**TRIGger[1|2]:COUNT?** [{MINimum|MAXimum}]

Sets trigger count.

Parameter	Typical Return
1 to 1,000,000; default, 1	10000
Set channel 2 trigger count to 10000: TRIG2:COUN 10000	

- Can be used with IMMEDIATE, EXTERNAL, TIMER, or BUS trigger source (**TRIGger[1|2]:SOURCE**).
- Applies only when INITiate[1|2]:CONTinuous is OFF.

**TRIGger[1|2]:DElay** {<seconds>|MINimum|MAXimum}  
**TRIGger[1|2]:DElay?** [{MINimum|MAXimum}]

Sets trigger delay, (time from assertion of trigger to occurrence of triggered event).

Parameter	Typical Return
0 to 1000 s, in resolution of 4 ns; default 0	+1.0500000000000000E-01
Set channel 1 trigger delay to 105 ms: TRIG:DEL 105e-3	

- Can be used with IMMEDIATE, EXTERNAL, TIMER, or BUS trigger source (TRIGger[1|2]:SOURCE).

**TRIGger[1|2]:LEVel** {<level>|MINimum|MAXimum}  
**TRIGger[1|2]:LEVel?** [{MINimum|MAXimum}]

Sets the output trigger level and input trigger threshold in volts. The trigger threshold is one-half of the trigger level.

Parameter	Typical Return
0.9 to 3.8 V	+3.3000000000000000E+00
Set the trigger level to 2 V: TRIG:LEV 2	

**TRIGger[1|2]:SLOPe** {POSitive|NEGative}  
**TRIGger[1|2]:SLOPe?**

Specifies polarity of trigger signal on rear-panel **Trig In** connector for any externally-triggered mode.

Parameter	Typical Return
{POSitive NEGative}, default POS (rising edge)	POS or NEG
Set trigger slope to falling edge: TRIG:SLOP NEG	

**TRIGger[1|2]:SOURce {IMMEDIATE|EXTERNAL|TIMER|BUS}**  
**TRIGger[1|2]:SOURce?**

Selects the trigger source for sequence, list, burst or sweep. The instrument accepts an immediate or timed internal trigger, an external hardware trigger from the rear-panel **Ext Trig** connector, or a software (bus) trigger.

Parameter	Typical Return
{IMMEDIATE EXTERNAL TIMER BUS}, default IMMEDIATE	IMM, EXT, TIM, BUS
Select external trigger source (trigger each time a low-true TTL pulse is received on the rear-panel trigger input): TRIG:SOUR EXT	

In triggered burst mode:

- The instrument outputs a waveform of the specified number of cycles (burst count) when a trigger is received. After the specified number of cycles have been output, the instrument stops and waits for next trigger.
- **IMMEDIATE (internal)**: the instrument outputs continuously when burst mode is enabled. The rate at which the burst is generated is determined by **BURSt:INTernal:PERiod**.
- **EXTERNAL**: the instrument accepts a hardware trigger at the rear-panel **Ext Trig** connector. The instrument outputs one burst of the specified number of cycles each time **Ext Trig** receives a level transition with the proper polarity (**TRIGger[1|2]:SLOPe**). External trigger signals during a burst are ignored.
- **BUS (software)**: the instrument initiates one burst each time a bus trigger (**\*TRG**) is received. The front panel [**Trigger**] key is illuminated when the instrument is waiting for a bus trigger.
- **EXTERNAL or BUS**: burst count and burst phase remain in effect, but burst period is ignored.
- **TIMER**: trigger events are spaced by a timer, with the first trigger as soon as **INIT** occurs.

In frequency sweep mode:

- **IMMEDIATE (internal)**: the instrument outputs continuously when the sweep is enabled. The period at which the sweep is generated is the sweep time (**SWEep:TIME**) plus 1 ms.
- **EXTERNAL**: the instrument accepts a hardware trigger at the rear-panel **Ext Trig** connector. The instrument initiates one sweep each time **Trig In** receives a TTL pulse of proper edge polarity (**TRIGger[1|2]:SLOPe**). The trigger period must be at least sweep time (**SWEep:TIME**) plus 1 ms.
- **BUS (software)**: the instrument initiates one sweep each time a bus trigger (**\*TRG**) is received. The front panel [**Trigger**] key is illuminated when the instrument is waiting for a bus trigger.
- **APPLY** sets trigger source to IMMEDIATE.

- To ensure synchronization with BUS source, send **\*WAI** (wait) so the instrument waits for all pending operations to complete before executing any additional commands. For example, the following command string guarantees that the first trigger is accepted and the operation is executed before second trigger is recognized.

TRIG:SOUR BUS;\*TRG;\*WAI;\*TRG;\*WAI

- Use **\*OPC?** or **\*OPC** to determine when the sweep or burst is complete. The **\*OPC?** query returns 1 to the output buffer when the sweep or burst is complete. The **\*OPC** command sets the Operation Complete bit (bit 0) in the Standard Event register when the sweep or burst is complete.

**TRIGger[1|2]:TImEr** {<seconds>|MINimum|MAXimum}

**TRIGger[1|2]:TImEr?** [{MINimum|MAXimum}]

Sets timer used when **TRIGger[1|2]:SOURce** is TImEr.

Parameter	Typical Return
1 $\mu$ s to 8,000 s	+3.000000000000000E-01
Set trigger timer to 300 ms on channel 2: TRIG2:TIM 0.3	

- In triggered burst mode (**BURSt:MODE TRIG**), this command supersedes **BURSt:INTernal:PERiod**.

UNIT:ANGLE {DEGREE|RADIAN|SECOND|DEFAULT}  
UNIT:ANGLE?

Specifies the angle units that displayed on the screen and used for specifying angles. The selected units are used for setting the starting phase for a burst (**BURSt:PHASe**) and for setting the phase offset (**PHASe**). The associated queries are also affected.

Parameter	Typical Return
{DEGREE RADIAN SECOND DEFAULT}, default DEGREE	DEG, RAD, or SEC
Set angle units to radians: UNIT:ANGL RAD	

- The SECond option is only available for the 33600 Series.
- The setting may be overridden by adding units to numeric parameter in command. For example, PHASE 90 DEG specifies 90 degrees, regardless of this setting.
- The front panel display always shows degrees, regardless of the UNIT:ANGLE setting.



UNIT:ARbitrary:ANGLE {DEGREE|RADIAn|SECond|SAMPle|DEFault}  
UNIT:ARbitrary:ANGLE?

Sets the units for specifying arbitrary waveform phase. The front panel will display the phase parameter in the selected units.

Parameter	Typical Return
{DEGREE RADIAn SECond SAMPle DEFault}, default DEGREE	DEG, RAD, SEC, or SAMP
Set the arbitrary waveform angle units to samples: UNIT:ARB:ANGL SAMP	

- The SECond and SAMPle options are only available for the 33600 Series models.
- You can also specify units by adding units to the numeric parameter: ARB:PHAS 10 DEG.

## VOLTage Subsystem Introduction

The VOLTage subsystem sets parameters related to output voltage.

### Example

The following is a typical procedure using the VOLTage subsystem.

1. **Select the waveform shape, amplitude and offset:** Use **APPLY** or the equivalent **FUNCTION**, **FREQUENCY**, **VOLTage**, and **VOLTage:OFFSet** commands to select the function, frequency, amplitude, and offset.
2. **Set units for output amplitude:****VOLTage:UNIT**
3. **Set output amplitude:****VOLTage**
4. **Set DC offset voltage:****VOLTage:OFFSet**
5. **Set high and low voltage level:****VOLTage:HIGH** and **VOLTage:LOW**
6. **Select output voltage limits to protect device under test (DUT):****VOLTage:LIMit:HIGH**, **VOLTage:LIMit:LOW**, and **VOLTage:LIMit:STATe**
7. **Select status of auto-ranging for all output functions:****VOLTage:RANGe:AUTO**
8. **Set voltage coupling to lock amplitude and offset of the channels together (2-channel instruments only):****VOLTageLCOUPle[:STATe]**

This example demonstrates the procedure outlined above:

```
SOURce1:FUNCTION SQU
SOURce1:FREQUENCY +1.0E+06
SOURce1:VOLTage +0.5
SOURce1:VOLTage:OFFSet +0.5
SOURce1:FUNCTION:SQUare:PERiod +1.0E-06
SOURce1:FUNCTION:PULSe:PERiod +1.0E-06
SOURce1:VOLTage:LIMit:LOW +0.0
```



```
SOURce1:VOLTage:LIMit:HIGH +1.0
SOURce1:VOLTage:LIMit:STATe 1
OUTP1 ON
SOURce2:FUNcTion SIN
SOURce2:FREQuency +1.0E+06
SOURce2:VOLTage +2.0
SOURce2:VOLTage:OFFSet +0.0
SOURce2:VOLTage:LIMit:LOW -1.0
SOURce2:VOLTage:LIMit:HIGH +1.0
SOURce2:VOLTage:LIMit:STATe 1
OUTP2 ON
```

[SOURce[1|2]:]VOLTage {<amplitude>|MINimum|MAXimum|DEFault}  
[SOURce[1|2]:]VOLTage? [{MINimum|MAXimum}]

Sets output amplitude.

Parameter	Typical Return
1 mVpp to <b>maximum allowed for waveform and model</b> , default 100 mVpp	+5.0000000000000E+00
Set output amplitude to 5 Vpp: VOLT 5 Vpp	

- The relationship between offset voltage and output amplitude is shown below. Vmax is the maximum peak voltage for the selected output termination (5 V for a 50 Ω load or 10 V for a high-impedance load).

$$|V_{\text{offset}}| < V_{\text{max}} - V_{\text{pp}}/2$$

If the specified offset voltage is not valid, the instrument will adjust it to the maximum DC voltage allowed with the specified amplitude. From the remote interface, a "Data out of range" error will also be generated.

- Differences between remote and front panel operation:*
  - Remote Interface:** Setting amplitude from the remote interface can change the offset in order to achieve the desired amplitude. The instrument will generate either a "Data out of range" or "Settings conflict" error. If the specified offset voltage is not valid, the instrument adjusts it to the maximum allowed with the specified amplitude.
  - Front Panel:** Setting amplitude from the front panel will not change the offset setting. If the specified amplitude is not valid, the instrument clips it to the maximum amplitude allowed with the current offset and generates a "Data out of range" error.
- Limits Due to Output Termination:* If the amplitude is 10 Vpp and you change the output termination setting from 50 Ω to "high impedance" (**OUTPUT[1|2]:LOAD INF**), the displayed amplitude doubles to 20 Vpp. Changing from "high impedance" to 50 Ω halves the displayed amplitude. The output termination setting does not affect the actual output voltage; it only changes the values displayed and queried from the remote interface. Actual output voltage depends on the connected load.
- Limits due to Output Coupling:*
  - Differences between remote and front panel operation:* If two channels are coupled, both channels' amplitude limitations will be checked before a change in amplitude is executed. If a change in output amplitude would exceed a LIMIT for either channel, or exceed the instrument's output specifications for either channel:
    - Remote interface:** The instrument will first adjust the offset, then if necessary, the amplitude of that channel to comply with the voltage limits or specification. The instrument will generate either a "Data out of range" or "Settings conflict" error.
    - Front panel:** The instrument will clip the amplitude value to the maximum value with the current offset setting. A "Data out of range" error will be generated.

- *Specifying Voltage Units:* You can set the output amplitude in Vpp, Vrms, or dBm by specifying the units as part of the VOLTage command VOLT 3.0 VRMS.

Use **VOLTage:UNIT** to specify output units for all subsequent commands.

You cannot specify output amplitude in dBm if output termination is set to high impedance. The units are automatically converted to Vpp.

- **Limits Due to Units Selection:** Amplitude limits are sometimes determined by the output units selected. This may occur when the units are Vrms or dBm due to the differences in various functions' crest factors. For example, if you change a 5 Vrms square wave (into 50 Ω) to a sine wave, the instrument will adjust the amplitude to 3.536 Vrms (the upper limit for sine in Vrms). The remote interface will also generate a "Settings conflict" error.
- **Arbitrary Waveform Limitations:** For arbitrary waveforms, amplitude is limited if the waveform data points do not span the full range of the output DAC (Digital-to-Analog Converter). For example, the built-in "Sinc" waveform does not use the full range of values, so its maximum amplitude is limited to 6.087 Vpp (into 50 Ω).
- **Changing amplitude may briefly disrupt output at certain voltages due to output attenuator switching.** The amplitude is controlled, however, so the output voltage will never exceed the current setting while switching ranges. To prevent this disruption, disable voltage autoranging using **VOLTage:RANGe:AUTO OFF**. The **APPLY** command automatically enables autoranging.
- You can also set the amplitude (with an associated offset voltage) by specifying a high level (**VOLTage:HIGH**) and low level (**VOLTage:LOW**). For example, if you set the high level to +2 V and the low level to -3 V, the resulting amplitude is 5 Vpp, with a -500 mV offset.
- To output a DC voltage level, select the DC voltage function (**FUNCTion DC**) and then set the offset voltage (**VOLTage:OFFSet**). Valid values are between ±5 VDC into 50 Ω or ±10 VDC into an open circuit. While the instrument is in DC mode, setting amplitude has no effect.

**[SOURce[1|2]:]VOLTage:COUPlE[:STATe] {ON|1|OFF|0}**  
**[SOURce[1|2]:]VOLTage:COUPlE[:STATe]?**

Enables or disables the maintaining of the same amplitude, offset, range, load, and units on both channels of a two-channel instrument. The command applies to both channels; the SOURce keyword is ignored.

Parameter	Typical Return
{ON 1 OFF 0}, default OFF	0 (OFF) or 1 (ON)
Enable voltage coupling: VOLT:COUP ON	

[SOURce[1|2]:]VOLTage:HIGH {<voltage>|MINimum|MAXimum|DEFault}  
[SOURce[1|2]:]VOLTage:HIGH? [{MINimum|MAXimum}]

[SOURce[1|2]:]VOLTage:LOW {<voltage>|MINimum|MAXimum|DEFault}  
[SOURce[1|2]:]VOLTage:LOW? [{MINimum|MAXimum}]

Set the waveform's high and low voltage levels.

Parameter	Typical Return
±5 VDC into 50 Ω, as long as HIGH is at least 1 mV greater than LOW. Defaults: HIGH +50 mV, LOW -50 mV.	+4.000000000000000E+00
Set high voltage level to 4 V: VOLT:HIGH 4	

- *Limits Due to Amplitude:* You can set the voltage levels to a positive or negative value with the restrictions shown below. Vpp is the maximum peak-to-peak amplitude for the selected output termination (10 Vpp into 50 Ω or 20 Vpp into an open circuit).

$$V_{\text{high}} - V_{\text{low}} \leq V_{\text{pp}} (\text{max}) \text{ and } V_{\text{high}}, V_{\text{low}} \leq V_{\text{pp}} (\text{max})/2$$

- *Differences between remote and front panel operation:*
  - **Remote Interface:** Setting the high or low level from the remote interface can change the high level or low level to achieve the desired setting. In this case either a "Data out of range" or "Settings conflict" error will occur. If the high level is set below the low level, the instrument will set the low level 1 mV less than the high level. If the high level is set below the LOW limit or the instrument output specifications, the low level will be set to the LOW limit or instrument output specification and the high level will be set 1 mV above the low level. A similar set of rules applies if the low level is set incorrectly.
  - **Front Panel:** Setting the high or low level from the front panel may clip that level setting in order to achieve the desired level setting, and a "Data out of range" error will be generated. The high level cannot be set below the low level from the front panel.
- Setting the high and low levels also sets the waveform amplitude and offset. For example, if you set the high level to +2 V and the low level to -3 V, the resulting amplitude is 5 Vpp, with a -500 mV offset.
- *Limits Due to Output Termination:* If the amplitude is 10 Vpp and you change the output termination setting from 50 Ω to "high impedance" (OUTPut[1|2]:LOAD INF), the displayed amplitude doubles to 20 Vpp. Changing from "high impedance" to 50 Ω halves the displayed amplitude. The output termination setting does not affect the actual output voltage; it only changes the values displayed and queried from the remote interface. Actual output voltage depends on the connected load.
- *Limits due to VOLTage:LIMit:STAtE:* If voltage limits are enabled, the level settings are checked against the specified limits (VOLTage:LIMit:HIGH, VOLTage:LIMit:LOW) before a level change is executed. If an output level change would exceed a LIMIT setting, the level is clipped to the maximum (or minimum) value allowed that will not exceed the LIMit setting and a "Settings conflict" error will be generated.

- *Limits due to Output Coupling:* If two channels are coupled, limitations are checked on both channels before a change in level is executed. If a change in level would exceed a LIMIT setting or exceed the instrument's output specifications for either channel, the level is clipped to the maximum (or minimum) value allowed that will not exceed the LIMit setting and a "Settings conflict" error will be generated.
- To invert the waveform relative to the offset voltage, use **OUTPut[1|2]:POLarity**.

**[SOURce[1|2]:]VOLTage:LIMit:HIGH {<voltage>|MINimum|MAXimum|DEFAULT}**  
**[SOURce[1|2]:]VOLTage:LIMit:HIGH? [{MINimum|MAXimum}]**

**[SOURce[1|2]:]VOLTage:LIMit:LOW {<voltage>|MINimum|MAXimum|DEFAULT}**  
**[SOURce[1|2]:]VOLTage:LIMit:LOW? {MINimum|MAXimum}?**

Sets the high and low limits for output voltage.

Parameter	Typical Return
±5 VDC into 50 Ω, as long as HIGH is at least 1 mV greater than LOW. Defaults: HIGH +50 mV, LOW -50 mV.	+5.0000000000000E+00
Set channel 1 output high limit to 5 V: VOLT:LIMIT:HIGH 5.0 VOLT:LIMIT:STATE ON	

- For voltage limits to be in effect, **VOLTage:LIMit:STATe** must be ON. If this is the case, and the high limit is set below the high value of the signal or the low limit is set above the low value of the signal, the relevant limit will be clipped to the high or low value of the signal. The instrument will generate either a "Data out of range" or "Settings conflict" error.
- The high limit sets the highest output voltage allowed to be set, including DC Offset and peak amplitude. It is set in reference to the current **OUTPUT[1|2]:LOAD** setting. If the specified LOAD impedance is not present at the instrument's output, then the output limit may not represent the actual voltages at the output connector. For example, if the output impedance is set to 50 Ω, but the actual load is high impedance, then the actual output peak voltage may be up to twice the specified limit voltage.
- *Specifying Voltage Units:* You can set the output limit voltage only in volts.
- When **VOLTage:COUple[:]STATe** is ON, and **VOLTage:LIMit:STATe** is ON, voltage limit settings on both channels affect maximum amplitude and offset voltage settings on both channels. The most restrictive combination of high and low limits from either channel is used.

[SOURCE[1|2]:]VOLTage:LIMit:STATe {ON|1|OFF|0}  
[SOURCE[1|2]:]VOLTage:LIMit:STATe?

Enables or disables output amplitude voltage limits.

Parameter	Typical Return
{ON 1 OFF 0}, default OFF	0 (OFF) or 1 (ON)
Set and enable $\pm 2.5$ V output limits on channel 1: VOLT:LIM:HIGH 2.5 VOLT:LIM:LOW -2.5 VOLT:LIM:STAT ON	

- When this is turned ON, if the present settings of amplitude and offset exceed the limits, then the limits will be disabled. The instrument will generate either a "Settings conflict" error.
- When **VOLTage:COUPlE[:STATe]** is ON, and **VOLTage:LIMit:STATe** is ON, voltage limit settings on both channels affect maximum amplitude and offset voltage settings on both channels. The most restrictive combination of high and low limits from either channel is used.
- Limits are set in reference to the current setting of **OUTPut[1|2]:LOAD**. If the specified LOAD impedance is not present at the instrument's output, then the output limit may not represent the actual voltages at the output connector. For example, if the output impedance is set to 50  $\Omega$ , but the actual load is high impedance, then the actual output peak voltage may be up to twice the specified limit voltage.

[SOURce[1|2]:]VOLTage:OFFSet {<offset>|MINimum|MAXimum|DEFault}  
[SOURce[1|2]:]VOLTage:OFFSet? [{MINimum|MAXimum}]

Sets DC offset voltage.

Parameter	Typical Return
± 5 VDC into 50 Ω, default 0	+1.00000000000000E-01
Set offset voltage to 100 mV: VOLT:OFFS 100 mV	

- The relationship between offset voltage and output amplitude is shown below.

$$|V_{offset}| < V_{max} - V_{pp}/2$$

- Differences between remote and front panel operation:
  - **Remote Interface:** Setting the offset from the remote interface can change the amplitude in order to achieve the desired offset setting. The instrument will generate either a "Data out of range" or "Settings conflict" error.
  - **Front Panel:** Setting the offset from the front panel will not change the amplitude in order to achieve the desired offset setting. If the specified offset is not valid, the instrument will clip it to the maximum offset allowed with the current amplitude and generate a "Data out of range" error.
- Limits Due to Output Termination: The offset range depends on the output termination setting. For example, if you set offset to 100 mVDC and then change output termination from 50 Ω to "high impedance," the offset voltage displayed on the front panel doubles to 200 mVDC (no error is generated). If you change from "high impedance" to 50 Ω, the displayed offset voltage will be halved. See **OUTPut[1|2]:LOAD** for details. Changing the output termination setting does not change the voltage present at the output terminals of the instrument. This only changes the displayed values on the front panel and the values queried from the remote interface. The voltage present at the instrument's output depends on the load connected to the instrument. See **OUTPut[1|2]:LOAD** for details.
- Limits due to Output Coupling: If two channels are coupled, limitations of setting offset will be checked on both channels before a change in offset is executed. If a change in offset would exceed a LIMIT setting, or exceed the instrument's output specifications for either channel:
  - *Remote Interface:* First the amplitude and then if necessary, the offset of that channel will be adjusted to comply with the voltage limits or specification. The instrument will generate either a "Data out of range" or "Settings conflict" error.
  - *Front panel:* The offset value is clipped to the maximum value allowed that will not exceed the LIMIT setting, and a "Data out of range" error will be generated.
- Arbitrary Waveform Limitations: For arbitrary waveforms, amplitude is limited if the waveform data points do not span the full range of the output DAC (Digital-to-Analog Converter). For example, the built-in "Sinc" waveform does not use the full range of values, so its maximum amplitude is limited to 6.087 Vpp (into 50 Ω).

- Changing amplitude may briefly disrupt output at certain voltages due to output attenuator switching. The amplitude is controlled, however, so the output voltage will never exceed the current setting while switching ranges. To prevent this disruption, disable voltage autoranging using **VOLTage:RANGe:AUTO OFF**. The **APPLY** command automatically enables autoranging.
- Setting the high and low levels also sets the waveform amplitude and offset. For example, if you set the high level to +2 V and the low level to -3 V, the resulting amplitude is 5 Vpp, with a -500 mV offset.
- To output a DC voltage level, select the DC voltage function (**FUNCTION DC**) and then set the offset voltage (**VOLTage:OFFSet**). Valid values are between  $\pm 5$  VDC into 50  $\Omega$  or  $\pm 10$  VDC into an open circuit. While the instrument is in DC mode, setting amplitude has no effect.

**[SOURCE[1|2]:]VOLTage:RANGe:AUTO {OFF|0|ON|1|ONCE}**  
**[SOURCE[1|2]:]VOLTage:RANGe:AUTO?**

Disables or enables voltage autoranging for all functions. Selecting ONCE performs an immediate autorange and then turns autoranging OFF

Parameter	Typical Return
{OFF 0 ON 1 ONCE}, default ON	0 (OFF) or 1 (ON)
Turn voltage autoranging OFF: VOLT:RANG:AUTO 0	

- In the default mode, autoranging is enabled and the instrument automatically selects the optimal settings for the output waveform generator and attenuator.
- With autoranging disabled (OFF), the instrument uses the instrument's current gain and attenuator settings.
- The **APPLY** command overrides the voltage autorange setting and automatically enables autoranging (ON).
- Disabling autoranging eliminates momentary disruptions caused by attenuator switching while changing amplitude. However, the amplitude and offset accuracy and resolution (and waveform fidelity) may be adversely affected when reducing the amplitude below the expected range change.
- If a **VOLTage:COUPle[:STATe]** is ON, changing this setting on either channel changes it on both.



[SOURce[1|2]:]VOLTage:UNIT {VPP|VRMS|DBM}  
[SOURce[1|2]:]VOLTage:UNIT?

Selects the units for output amplitude.

Parameter	Typical Return
{VPP VRMS DBM}, default VPP	VPP, VRMS, or DBM
Set output amplitude units to Vrms: VOLT:UNIT VRMS	

- Does not affect offset voltage (VOLTage:OFFSet), high level (VOLTage:HIGH) or low level (VOLTage:LOW). They all use units of volts.
- The instrument uses the current units selection for both front panel and remote interface operations. For example, if you select "VRMS" from the remote interface (VOLTage:UNIT VRMS), the units are displayed as "VRMS" on the front panel.
- Command applies to VOLTage? query results.
- Output units for amplitude cannot be set to dBm if the output termination is set to "high impedance." The units are automatically converted to Vpp.
- Arbitrary waveform sequences do not accept units of Vrms or dBm.
- Unless you specify the units as part of either the VOLTage command or one of the APPLy commands, the VOLTage:UNIT command takes precedence. For example, if you select VOLTage:UNIT VRMS and do not include units with an APPLy command, the <amplitude> in the APPLy command will be in "Vrms".

## Programming Examples

These programming examples help you get started with common tasks.

[Configure a Sine Wave](#)

[Configure a Square Wave](#)

[Configure a Ramp Wave](#)

[Configure a Pulse Wave](#)

[Create a List of Frequencies](#)

[Configure an Arbitrary Waveform](#)

### Configure a Sine Wave

This section describes the configuration of a sine wave function.

## Description

A sine wave has amplitude, offset, and phase relative to sync pulse. Its amplitude and offset can also be set using high and low voltage values.

## Example

The following waveform can be set up with the series of SCPI commands, where high and low can be used in place of **SOUR:VOLT** and **SOUR:VOLT:OFFS**.

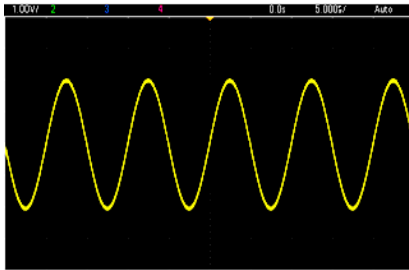

The following commands produce the sine wave shown above.

```
FUNCTION SIN
FREQUENCY +1.0E+05
VOLTage:HIGH +2.0
VOLTage:LOW +0.0
OUTPut ON
PHASe +90.0
```

## Remarks

- Although period can be adjusted from the front panel, there is no **SOUR:FUNC:SIN:PER** or **SOUR:PER** command that can be used in addition to **SOUR:FREQ**.

## Configure a Square Wave

### Description

A square wave has amplitude, offset, and phase relative to sync pulse. It also has duty cycle and period. Its amplitude and offset can also be set using high and low voltage values.

### Example

The following waveform can be set up with the series of SCPI commands, where high and low can be used in place of **SOUR:VOLT** and **SOUR:VOLT:OFFS**.

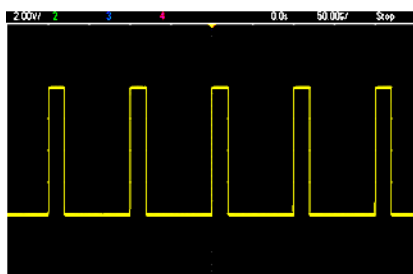

The following commands produce the square wave shown above.

```
FUNC SQU
FUNC:SQU:DCYC +20.0
FREQ +1.0E+04
VOLT:HIGH +4.0
VOLT:LOW +0.0
OUTP 1
```

### Remarks

- For Square Wave, if you change **SOUR:FREQ**, the **SOUR:FUNC:SQU:PER** will change. For example, **SOUR:FREQ +2.0E+03** is equivalent to **SOUR:FUNC:SQU:PER +5.0E-04**.

## Configure a Ramp Wave

### Description

A ramp wave has amplitude, offset, and phase relative to sync pulse. It also has symmetry for creating triangular and other similar waveforms. Its amplitude and offset can also be set using high and low voltage values.

### Example

The following waveform can be set up with the series of SCPI commands, where high and low can be used in place of **SOUR:VOLT** and **SOUR:VOLT:OFFS**.

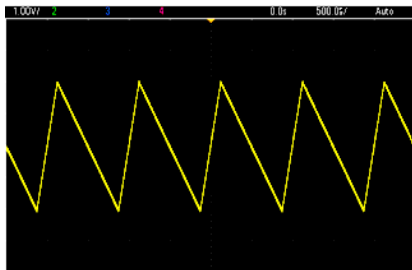

The following commands produce the ramp wave shown above.

```
FUNCTION RAMP
FUNCTION:RAMP:SYMMetry 25
FREQ +1.0E+03
VOLTage +2.0
```

```
VOLTage:OFFSet +1.0  
OUTP 1
```

## Remarks

- Ramp frequency is limited to 200 kHz.
- Although period can be adjusted from the instrument's front panel, there is no SOUR:FUNC:RAMP:PER or SOUR:PER command that can be used in addition to SOUR:FREQ.

## Configure a Pulse Wave

### Description

A pulse wave has amplitude, offset, and phase relative to sync pulse. It also adds edge slope, period, and duty cycle (or pulse width, depending on the FUNC:PULSe:HOLD configuration). Its amplitude and offset can also be set using high and low voltage values.

### Example

The following waveform can be set up with the series of SCPI commands, where high and low can be used in place of SOUR:VOLT and SOUR:VOLT:OFFS.

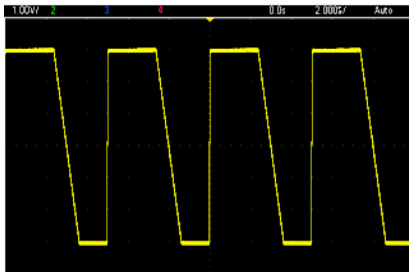

The following commands produce the pulse wave shown above.

```
FUNC PULS  
FUNC:PULS:TRAN:LEAD 4E-8  
FUNC:PULS:TRAN:TRA 1E-6  
FUNC:PULS:WIDT 3E-6  
FREQ 2E5  
VOLT 3  
OUTP ON
```

## Remarks

- You can use FUNC:PULS:PER instead of FREQ. These commands are paired; changing one changes the other.
- Pulse can be specified by width or duty cycle, which are also coupled. Use FUNCTION:PULSe:HOLD DCYC to specify that duty cycle is held constant value as frequency or period changes. Use FUNCTION:PULSe:HOLD WIDTH to specify that pulse width is held constant as frequency or period changes.

## Create a List of Frequencies

### Description

The **LIST** commands set the instrument's output frequency according to entries in a frequency list, which allows fast changing to frequencies in a list of up to 128 frequencies. The frequencies to be used are entered using the **LIST:FREQUENCY** command, or they may be read from a file using **MMEMORY:LOAD:LIST [1|2]**.

### Examples

The following code demonstrates the **LIST:FREQUENCY** method.

```
FUNCTION SQU
TRIGGER:SOURCE IMMEDIATE
FREQUENCY:MODE LIST
LIST:DWELL +5.0E-03
LIST:FREQUENCY +1.0E+03,+3.0E+03,+7.0E+03
VOLTAGE +1.0
OUTPUT 1
```

The results of this code are shown below.

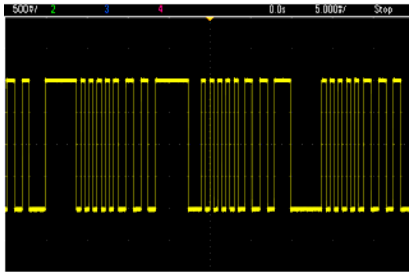

## Configure an arbitrary waveform

This section describes the configuration of an arbitrary waveform.

### Description

A user-created arbitrary waveform has amplitude, offset, sample rate, and filter type. These can be set when the arbitrary waveform file (.arb or .barb extension) is loaded into waveform memory. The beginning of a typical arbitrary waveform is shown below; note that amplitude and offset are represented by high and low voltage values:

```
File Format:1.10
Checksum:0
Channel Count:1
Sample Rate:20000.000000
High Level:2.000000
Low Level:0.000000
Marker Point:50
```

```
Data Type:"short"  
Filter:"off"  
Data Points:100  
Data:  
23259  
23114
```

The **23259** and **23114** lines after the **Data:** line are ASCII DAC codes representing the first two waveform data values. If the waveform's DAC codes do not range from -32767 to + 32767, the output amplitude is asymmetric.

In firmware revisions 1.12 and before, the instrument did not update waveform metadata (sample rate, voltage range, and filter setting) when switching from one arbitrary waveform to another. The new arbitrary waveform adopted the metadata of the waveform already in memory. Therefore, an arbitrary waveform designed to play at one voltage range, sample rate, and filter setting (as specified in the waveform's metadata) was changed to another set of metadata. After firmware revision 1.12, arbitrary waveforms load any metadata present in the arbitrary waveform file, so that they play the way they previously played.

Built-in waveforms make few or no changes when loaded into waveform memory. They play according to the instrument's current configuration. For example, see the beginning of Haversine.arb, shown below.

```
Copyright: Keysight Technologies, 2010  
File Format:1.0  
Channel Count:1  
Data Points:40  
Data:  
0  
202  
802
```

Because of the missing metadata, the current settings for voltage range, sample rate, and filter setup are used.

### Example

The following code loads and modifies a built-in arbitrary waveform.

```
FUNCTION ARB  
VOLTage +3  
VOLTage:OFFSet +1  
FUNC:ARB:SRAT 1E5  
FUNCTION:ARbitrary "INT:\BUILTIN\EXP_RISE.ARB"  
OUTPut 1
```

The waveform resulting from these commands is shown below.

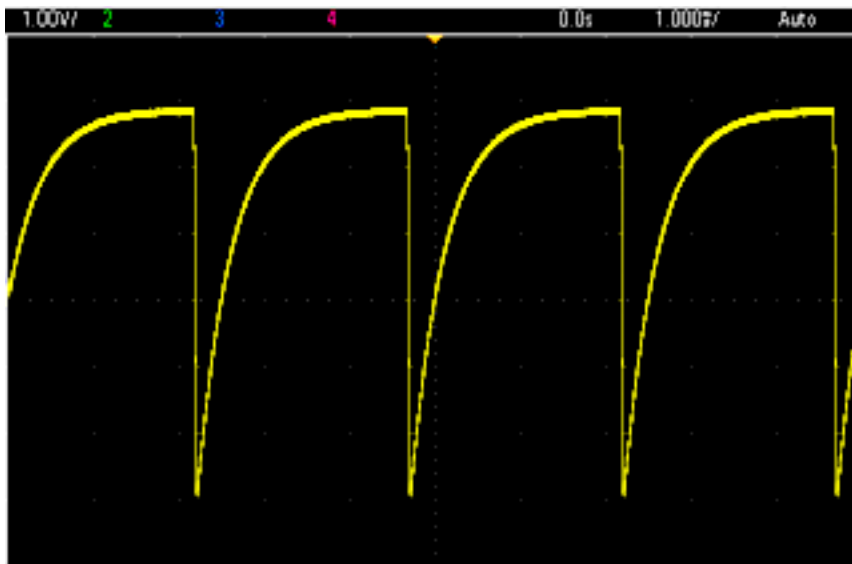

## Keysight Trueform Series Command Quick Reference

See the [Syntax Conventions](#) for SCPI.

### APPLY Commands

[SOURCE[1|2]:]APPLY?

[SOURCE[1|2]:]APPLY:ARbitrary [{<sample\_rate>|MIN|MAX|DEF} [, {<amplitude>|MIN|MAX|DEF} [, {<offset>|MIN|MAX|DEF}]]]

[SOURCE[1|2]:]APPLY:DC [{<frequency>|MIN|MAX|DEF} [, {<amplitude>|MIN|MAX|DEF} [, {<offset>|MIN|MAX|DEF}]]]

[SOURCE[1|2]:]APPLY:NOISE [{<frequency>|MIN|MAX|DEF} [, {<amplitude>|MIN|MAX|DEF} [, {<offset>|MIN|MAX|DEF}]]]

[SOURCE[1|2]:]APPLY:PRBS [{<frequency>|MIN|MAX|DEF} [, {<amplitude>|MIN|MAX|DEF} [, {<offset>|MIN|MAX|DEF}]]]

[SOURCE[1|2]:]APPLY:PULSE [{<frequency>|MIN|MAX|DEF} [, {<amplitude>|MIN|MAX|DEF} [, {<offset>|MIN|MAX|DEF}]]]

[SOURCE[1|2]:]APPLY:RAMP [{<frequency>|MIN|MAX|DEF} [, {<amplitude>|MIN|MAX|DEF} [, {<offset>|MIN|MAX|DEF}]]]

[SOURCE[1|2]:]APPLY:SINusoid [{<frequency>|MIN|MAX|DEF} [, {<amplitude>|MIN|MAX|DEF} [, {<offset>|MIN|MAX|DEF}]]]

[SOURCE[1|2]:]APPLY:SQUare [{<frequency>|MIN|MAX|DEF} [, {<amplitude>|MIN|MAX|DEF} [, {<offset>|MIN|MAX|DEF}]]]

[SOURCE[1|2]:]APPLY:TRIangle [{<frequency>|MIN|MAX|DEF} [, {<amplitude>|MIN|MAX|DEF} [, {<offset>|MIN|MAX|DEF}]]]

## DATA Commands

[SOURCE[1|2]:]DATA:ARBitrary2:FORMat {AABB|ABAB}

[SOURCE[1|2]:]DATA:ARBitrary[1|2] <arb\_name>, {<binary\_block>|<value>, <value>, ...}

[SOURCE[1|2]:]DATA:ARBitrary[1|2]:DAC <arb\_name>, {<binary\_block>|<value>, <value>, ...}

[SOURCE[1|2]:]DATA:ATTRibute:AVERage? [<arb\_name>]

[SOURCE[1|2]:]DATA:ATTRibute:CFACTOR? [<arb\_name>]

[SOURCE[1|2]:]DATA:ATTRibute:POINTS? [<arb\_name>]

[SOURCE[1|2]:]DATA:ATTRibute:PTPeak? [<arb\_name>]

[SOURCE[1|2]:]DATA:SEQuence <block\_descriptor>

[SOURCE[1|2]:]DATA:VOLatile:CATalog?

[SOURCE[1|2]:]DATA:VOLatile:CLEar

[SOURCE[1|2]:]DATA:VOLatile:FREE?



## Output Configuration Commands

[SOURce[1|2]:]FUNction <function>  
[SOURce[1|2]:]FUNction?

### FREQUENCY CONTROL

[SOURce[1|2]:]FREQuency {<frequency>|MINimum|MAXimum|DEFault}  
[SOURce[1|2]:]FREQuency? [{MINimum|MAXimum}]

[SOURce[1|2]:]FREQuency:CENTer {<frequency>|MINimum|MAXimum|DEFault}  
[SOURce[1|2]:]FREQuency:CENTer? [{MINimum|MAXimum}]

[SOURce[1|2]:]FREQuency:COUple:MODE {OFFSet|RATio}  
[SOURce[1|2]:]FREQuency:COUple:MODE?

[SOURce[1|2]:]FREQuency:COUple:OFFSet {<frequency>|MINimum|MAXimum|DEFault}  
[SOURce[1|2]:]FREQuency:COUple:OFFSet?

[SOURce[1|2]:]FREQuency:COUple:RATio <ratio>  
[SOURce[1|2]:]FREQuency:COUple:RATio?

[SOURce[1|2]:]FREQuency:COUple[:STATe] {ON|1|OFF|0}  
[SOURce[1|2]:]FREQuency:COUple[:STATe]?

[SOURce[1|2]:]FREQuency:MODE {CW|LIST|SWEep|FIXed}  
[SOURce[1|2]:]FREQuency:MODE?

[SOURce[1|2]:]FREQuency:SPAN {<frequency>|MINimum|MAXimum|DEFault}  
[SOURce[1|2]:]FREQuency:SPAN? [{MINimum|MAXimum}]

[SOURce[1|2]:]FREQuency:STARt {<frequency>|MINimum|MAXimum|DEFault}  
[SOURce[1|2]:]FREQuency:STARt? [{MINimum|MAXimum}]

[SOURce[1|2]:]FREQuency:STOP {<frequency>|MINimum|MAXimum|DEFault}  
[SOURce[1|2]:]FREQuency:STOP? [{MINimum|MAXimum}]

### FREQUENCY LIST MODE

[SOURce[1|2]:]LIST:DWELL {<seconds>|MINimum|MAXimum}  
[SOURce[1|2]:]LIST:DWELL? [{MINimum|MAXimum}]

[SOURce[1|2]:]LIST:FREQuency <freq1>[, <freq2>, etc.]  
[SOURce[1|2]:]LIST:FREQuency?

[SOURce[1|2]:]LIST:FREQuency:POINts? [{MINimum|MAXimum}]

MMEMory:LOAD:LIST[1|2] <filename>

MMEMory:STORe:LIST[1|2] <filename>

## VOLTAGE

[SOURce[1|2]:]VOLTage {<amplitude>|MINimum|MAXimum|DEFault}  
[SOURce[1|2]:]VOLTage? [{MINimum|MAXimum}]

[SOURce[1|2]:]VOLTage:COUple[:STATe] {ON|1|OFF|0}  
[SOURce[1|2]:]VOLTage:COUple[:STATe]?

[SOURce[1|2]:]VOLTage:HIGH {<voltage>|MINimum|MAXimum|DEFault}  
[SOURce[1|2]:]VOLTage:HIGH? [{MINimum|MAXimum}]

[SOURce[1|2]:]VOLTage:LOW {<voltage>|MINimum|MAXimum|DEFault}  
[SOURce[1|2]:]VOLTage:LOW? [{MINimum|MAXimum}]

[SOURce[1|2]:]VOLTage:LIMit:HIGH {<voltage>|MINimum|MAXimum|DEFault}  
[SOURce[1|2]:]VOLTage:LIMit:HIGH? [{MINimum|MAXimum}]

[SOURce[1|2]:]VOLTage:LIMit:LOW {<voltage>|MINimum|MAXimum|DEFault}  
[SOURce[1|2]:]VOLTage:LIMit:LOW? [{MINimum|MAXimum}]?

[SOURce[1|2]:]VOLTage:LIMit:STATe {ON|1|OFF|0}  
[SOURce[1|2]:]VOLTage:LIMit:STATe?

[SOURce[1|2]:]VOLTage:OFFSet {<offset>|MINimum|MAXimum|DEFault}  
[SOURce[1|2]:]VOLTage:OFFSet? [{MINimum|MAXimum}]

[SOURce[1|2]:]VOLTage:RANGe:AUTO {OFF|0|ON|1|ONCE}  
[SOURce[1|2]:]VOLTage:RANGe:AUTO?

[SOURce[1|2]:]VOLTage:UNIT {VPP|VRMS|DBM}  
[SOURce[1|2]:]VOLTage:UNIT?

## SQUARE WAVE

[SOURce[1|2]:]FUNction:SQUare:DCYcle {<percent>|MINimum|MAXimum}  
[SOURce[1|2]:]FUNction:SQUare:DCYcle? [{MINimum|MAXimum}]

[SOURce[1|2]:]FUNction:SQUare:PERiod {<seconds>|MINimum|MAXimum|DEFault}  
[SOURce[1|2]:]FUNction:SQUare:PERiod? [{MINimum|MAXimum}]

## RAMP

[SOURce[1|2]:]FUNction:RAMP:SYMMetry {<percent>|MINimum|MAXimum|DEFault}  
[SOURce[1|2]:]FUNction:RAMP:SYMMetry? [{MINimum|MAXimum}]

## NOISE

[SOURce[1|2]:]FUNction:NOISe:BANDwidth {<bandwidth>|MINimum|MAXimum|DEFault}  
[SOURce[1|2]:]FUNction:NOISe:BANDwidth? [{MINimum|MAXimum}]

## PRBS

[SOURCE[1|2]:]FUNCTION:PRBS:BRATE {<bit\_rate>|MINimum|MAXimum|DEFAULT}

[SOURCE[1|2]:]FUNCTION:PRBS:BRATE? [{MINimum|MAXimum}]

[SOURCE[1|2]:]FUNCTION:PRBS:DATA <sequence\_type>

[SOURCE[1|2]:]FUNCTION:PRBS:DATA?

[SOURCE[1|2]:]FUNCTION:PRBS:TRANSITION[:BOTH] {<seconds>|MINimum|MAXimum|DEFAULT}

[SOURCE[1|2]:]FUNCTION:PRBS:TRANSITION[:BOTH]? [{MINimum|MAXimum}]

## ARBITRARY WAVEFORM

[SOURCE[1|2]:]FUNCTION:ARbitrary {<filename>}

[SOURCE[1|2]:]FUNCTION:ARbitrary?

[SOURCE[1|2]:]FUNCTION:ARbitrary:ADVance {TRIGger|SRATE}

[SOURCE[1|2]:]FUNCTION:ARbitrary:ADVance?

[SOURCE[1|2]:]FUNCTION:ARbitrary:FILTer {NORMal|STEP|OFF}

[SOURCE[1|2]:]FUNCTION:ARbitrary:FILTer?

[SOURCE[1|2]:]FUNCTION:ARbitrary:FREQuency {<frequency>|MINimum|MAXimum|DEFault}

[SOURCE[1|2]:]FUNCTION:ARbitrary:FREQuency? {MINimum|MAXimum}

[SOURCE[1|2]:]FUNCTION:ARbitrary:PERiod {<period>|MINimum|MAXimum}DEFault}

[SOURCE[1|2]:]FUNCTION:ARbitrary:PERiod? {MINimum|MAXimum}

[SOURCE[1|2]:]FUNCTION:ARbitrary:POINts?

[SOURCE[1|2]:]FUNCTION:ARbitrary:PTPeak {<voltage>|MINimum|MAXimum|DEFault}

[SOURCE[1|2]:]FUNCTION:ARbitrary:PTPeak? [{MINimum|MAXimum}]

[SOURCE[1|2]:]FUNCTION:ARbitrary:SRATE {<sample\_rate>|MINimum|MAXimum|DEFault}

[SOURCE[1|2]:]FUNCTION:ARbitrary:SRATE? {MINimum|MAXimum}

FUNCTION:ARbitrary:BALance[:STATE] {ON|1|OFF|0} **(IQ Player option only)**

FUNCTION:ARbitrary:BALance[:STATE]? **(IQ Player option only)**

FUNCTION:ARbitrary:BALance:GAIN {<percent>|MINimum|MAXimum|DEFine} **(IQ Player option only)**

FUNCTION:ARbitrary:BALance:GAIN? [{MINimum|MAXimum}] **(IQ Player option only)**

FUNCTION:ARbitrary:BALance:OFFSet{1|2} {<volts>|MINimum|MAXimum|DEFault} **(IQ Player option only)**

FUNCTION:ARbitrary:BALance:OFFSet{1|2}? [MINimum|MAXimum] **(IQ Player option only)**

FUNCTION:ARbitrary:SKEW[:STATE] {ON|1|OFF|0} **(IQ Player option only)**

FUNCTION:ARbitrary:SKEW[:STATE]? **(IQ Player option only)**

FUNCTION:ARbitrary:SKEW:TIME [{<time>|MINimum|MAXimum|DEFault}] **(IQ Player option only)**

FUNCTION:ARbitrary:SKEW:TIME? [{MINimum|MAXimum}] **(IQ Player option only)**

[SOURCE[1|2]:]FUNCTION:ARbitrary:SYNChronize

[SOURCE[1|2]:]RATE:COUple[:STATE] {ON|1|OFF|0}

[SOURCE[1|2]:]RATE:COUple[:STATE]?

[SOURCE[1|2]:]RATE:COUple:MODE {OFFSet|RATio}

[SOURCE[1|2]:]RATE:COUple:MODE?

[SOURCE[1|2]:]RATE:COUple:OFFSet {<sample\_rate>|MINimum|MAXimum|DEFault}

[SOURCE[1|2]:]RATE:COUple:OFFSet?

[SOURCE[1|2]:]RATE:COUple:RATio {<ratio>|MINimum|MAXimum}

[SOURCE[1|2]:]RATE:COUple:RATio? [{MINimum|MAXimum}]

## OUTPUT

OUTPut[1|2] {ON|1|OFF|0}  
OUTPut[1|2]?

OUTPut[1|2]:LOAD {<ohms>|INFinity|MINimum|MAXimum|DEFault}  
OUTPut[1|2]:LOAD? [{MINimum|MAXimum}]

OUTPut[1|2]:MODE {NORMal|GATed}  
OUTPut[1|2]:MODE?

OUTPut[1|2]:POLarity {NORMal|INVerted}  
OUTPut[1|2]:POLarity?

OUTPut:SYNC {ON|1|OFF|0}  
OUTPut:SYNC?

OUTPut[1|2]:SYNC:MODE {NORMal|CARRier|MARKer}  
OUTPut[1|2]:SYNC:MODE?

OUTPut[1|2]:SYNC:POLarity {NORMal|INVerted}  
OUTPut[1|2]:SYNC:POLarity?

OUTPut:SYNC:SOURce {CH1|CH2}  
OUTPut:SYNC:SOURce?

OUTPut:TRIGger {ON|1|OFF|0}  
OUTPut:TRIGger?

OUTPut:TRIGger:SLOPe {POSitive|NEGative}  
OUTPut:TRIGger:SLOPe?

OUTPut:TRIGger:SOURce {CH1|CH2}  
OUTPut:TRIGger:SOURce?

### Pulse Configuration Commands

[SOURce[1|2]:]FUNCTION:PULSe:DCYCLE {<percent>|MINimum|MAXimum|DEFault}  
[SOURce[1|2]:]FUNCTION:PULSe:DCYCLE? [{MINimum|MAXimum}]

[SOURce[1|2]:]FUNCTION:PULSe:HOLD {WIDTh|DCYCLE}  
[SOURce[1|2]:]FUNCTION:PULSe:HOLD?

[SOURce[1|2]:]FUNCTION:PULSe:PERiod {<seconds>|MINimum|MAXimum|DEFault}  
[SOURce[1|2]:]FUNCTION:PULSe:PERiod? [{MINimum|MAXimum}]

[SOURce[1|2]:]FUNCTION:PULSe:TRANSition[:BOTH] {<seconds>|MINimum|MAXimum|DEFault}

[SOURce[1|2]:]FUNCTION:PULSe:TRANSition:LEADing {<seconds>|MINimum|MAXimum|DEFault}  
[SOURce[1|2]:]FUNCTION:PULSe:TRANSition:LEADing? [{MINimum|MAXimum}]

[SOURce[1|2]:]FUNCTION:PULSe:TRANSition:TRAILing {<seconds>|MINimum|MAXimum|DEFault}  
[SOURce[1|2]:]FUNCTION:PULSe:TRANSition:TRAILing? [{MINimum|MAXimum}]

[SOURce[1|2]:]FUNCTION:PULSe:WIDTh {<seconds>|MINimum|MAXimum|DEFault}  
[SOURce[1|2]:]FUNCTION:PULSe:WIDTh? [{MINimum|MAXimum}]

## Modulation Commands

### AM

[SOURCE[1|2]:]AM[:DEPTH] {<depth\_in\_percent>|MINimum|MAXimum}  
[SOURCE[1|2]:]AM[:DEPTH]? [{MINimum|MAXimum}]

[SOURCE[1|2]:]AM:DSSC {ON|1|OFF|0}  
[SOURCE[1|2]:]AM:DSSC?

[SOURCE[1|2]:]AM:INTERNAL:FREQUENCY {<frequency>|MINimum|MAXimum|DEFAULT}  
[SOURCE[1|2]:]AM:INTERNAL:FREQUENCY? [{MINimum|MAXimum}]

[SOURCE[1|2]:]AM:INTERNAL:FUNCTION <function>  
[SOURCE[1|2]:]AM:INTERNAL:FUNCTION?

[SOURCE[1|2]:]AM:SOURCE {INTERNAL|EXTERNAL|CH1|CH2}  
[SOURCE[1|2]:]AM:SOURCE?

[SOURCE[1|2]:]AM:STATE {ON|1|OFF|0}  
[SOURCE[1|2]:]AM:STATE?

### FM

[SOURCE[1|2]:]FM[:DEVIATION] {<peak\_deviation\_in\_Hz>|MINimum|MAXimum|DEFAULT}  
[SOURCE[1|2]:]FM[:DEVIATION]? [{MINimum|MAXimum}]

[SOURCE[1|2]:]FM:INTERNAL:FREQUENCY {<frequency>|MINimum|MAXimum|DEFAULT}  
[SOURCE[1|2]:]FM:INTERNAL:FREQUENCY? [{MINimum|MAXimum}]

[SOURCE[1|2]:]FM:INTERNAL:FUNCTION <function>  
[SOURCE[1|2]:]FM:INTERNAL:FUNCTION?

[SOURCE[1|2]:]FM:SOURCE {INTERNAL|EXTERNAL|CH1|CH2}  
[SOURCE[1|2]:]FM:SOURCE?

[SOURCE[1|2]:]FM:STATE {ON|1|OFF|0}  
[SOURCE[1|2]:]FM:STATE?

### BPSK Commands

[SOURCE[1|2]:]BPSK:SOURCE {INTERNAL|EXTERNAL}  
[SOURCE[1|2]:]BPSK:SOURCE?

[SOURCE[1|2]:]BPSK:STATE {ON|1|OFF|0}  
[SOURCE[1|2]:]BPSK:STATE?

[SOURCE[1|2]:]BPSK:INTERNAL:RATE {<modulating\_frequency>|MINimum|MAXimum|DEFAULT}  
[SOURCE[1|2]:]BPSK:INTERNAL:RATE? [{MINimum|MAXimum}]

[SOURCE[1|2]:]BPSK[:PHASE] {<angle>|MINimum|MAXimum|DEFAULT}  
[SOURCE[1|2]:]BPSK[:PHASE]? [{MINimum|MAXimum}]

## PM

[SOURCE[1|2]:]PM:DEVIation {<deviation in degrees>|MINimum|MAXimum|DEFault}  
[SOURCE[1|2]:]PM:DEVIation? [{MINimum|MAXimum}]

[SOURCE[1|2]:]PM:INTernal:FREQUency {<frequency>|MINimum|MAXimum|DEFault}  
[SOURCE[1|2]:]PM:INTernal:FREQUency? [{MINimum|MAXimum}]

[SOURCE[1|2]:]PM:INTernal:FUNCTion <function>  
[SOURCE[1|2]:]PM:INTernal:FUNCTion?

[SOURCE[1|2]:]PM:SOURce {INTernal|EXTernal|CH1|CH2}  
[SOURCE[1|2]:]PM:SOURce?

[SOURCE[1|2]:]PM:STATe {ON|1|OFF|0}  
[SOURCE[1|2]:]PM:STATe?

## FSK

[SOURCE[1|2]:]FSKey:FREQUency {<frequency>|MINimum|MAXimum|DEFault}  
[SOURCE[1|2]:]FSKey:FREQUency? [{MINimum|MAXimum}]

[SOURCE[1|2]:]FSKey:INTernal:RATE {<rate\_in\_Hz>|MINimum|MAXimum}  
[SOURCE[1|2]:]FSKey:INTernal:RATE? [{MINimum|MAXimum}]

[SOURCE[1|2]:]FSKey:SOURce {INTernal|EXTernal}  
[SOURCE[1|2]:]FSKey:SOURce?

[SOURCE[1|2]:]FSKey:STATe {ON|1|OFF|0}  
[SOURCE[1|2]:]FSKey:STATe?

## PWM

[SOURCE[1|2]:]PWM:DEVIation {<deviation>|MINimum|MAXimum|DEFault}  
[SOURCE[1|2]:]PWM:DEVIation? [{MINimum|MAXimum}]

[SOURCE[1|2]:]PWM:DEVIation:DCYClE {<deviation\_in\_pct>|MINimum|MAXimum|DEFault}  
[SOURCE[1|2]:]PWM:DEVIation:DCYClE? [{MINimum|MAXimum}]

[SOURCE[1|2]:]PWM:INTernal:FREQUency {<frequency>|MINimum|MAXimum|DEFault}  
[SOURCE[1|2]:]PWM:INTernal:FREQUency? [{MINimum|MAXimum}]

[SOURCE[1|2]:]PWM:INTernal:FUNCTion <function>  
[SOURCE[1|2]:]PWM:INTernal:FUNCTion?

[SOURCE[1|2]:]PWM:SOURce {INTernal|EXTernal|CH1|CH2}  
[SOURCE[1|2]:]PWM:SOURce?

[SOURCE[1|2]:]PWM:STATe {ON|1|OFF|0}  
[SOURCE[1|2]:]PWM:STATe?

## SUM

[SOURCE[1|2]:]SUM:AMPLitude {<amplitude>|MINimum|MAXimum|DEFAULT}

[SOURCE[1|2]:]SUM:AMPLitude? [{MINimum|MAXimum}]

[SOURCE[1|2]:]SUM:INTERNAL:FREQUENCY {<frequency>|MINimum|MAXimum|DEFAULT}

[SOURCE[1|2]:]SUM:INTERNAL:FREQUENCY? [{MINimum|MAXimum}]

[SOURCE[1|2]:]SUM:INTERNAL:FUNCTION <function>

[SOURCE[1|2]:]SUM:INTERNAL:FUNCTION?

[SOURCE[1|2]:]SUM:SOURCE {INTERNAL|EXTERNAL|CH1|CH2}

[SOURCE[1|2]:]SUM:SOURCE?

[SOURCE[1|2]:]SUM:STATE {ON|1|OFF|0}

[SOURCE[1|2]:]SUM:STATE?

## Frequency Sweep

[SOURCE[1|2]:]SWEep:HTIME {<hold\_time>|MINimum|MAXimum|DEFAULT}

[SOURCE[1|2]:]SWEep:HTIME? [{MINimum|MAXimum}]

[SOURCE[1|2]:]SWEep:RTIME {<return\_time>|MINimum|MAXimum|DEFAULT}

[SOURCE[1|2]:]SWEep:RTIME? [{MINimum|MAXimum}]

[SOURCE[1|2]:]SWEep:SPACing {LINEar|LOGarithmic}

[SOURCE[1|2]:]SWEep:SPACing?

[SOURCE[1|2]:]SWEep:STATE {ON|1|OFF|0}

[SOURCE[1|2]:]SWEep:STATE?

[SOURCE[1|2]:]SWEep:TIME {<seconds>|MINimum|MAXimum|DEFAULT}

[SOURCE[1|2]:]SWEep:TIME? [{MINimum|MAXimum}]

## Burst Mode

[SOURCE[1|2]:]BURSt:GATE:POLarity {NORMAL|INVERTed}

[SOURCE[1|2]:]BURSt:GATE:POLarity?

[SOURCE[1|2]:]BURSt:INTERNAL:PERiod {<seconds>|MINimum|MAXimum}

[SOURCE[1|2]:]BURSt:INTERNAL:PERiod? [{MINimum|MAXimum}]

[SOURCE[1|2]:]BURSt:MODE {TRIGgered|GATed}

[SOURCE[1|2]:]BURSt:MODE?

[SOURCE[1|2]:]BURSt:NCYCles {<num\_cycles>|INFinity|MINimum|MAXimum}

[SOURCE[1|2]:]BURSt:NCYCles? [{MINimum|MAXimum}]

[SOURCE[1|2]:]BURSt:PHASe {<angle>|MINimum|MAXimum}

[SOURCE[1|2]:]BURSt:PHASe? [{MINimum|MAXimum}]

[SOURCE[1|2]:]BURSt:STATE {ON|1|OFF|0}

[SOURCE[1|2]:]BURSt:STATE?



## Marker

[SOURCE[1|2]:]MARKer:CYCLE {<cycle\_num>|MINimum|MAXimum|DEFAULT}

[SOURCE[1|2]:]MARKer:FREQUENCY {<frequency>|MINimum|MAXimum|DEFAULT}

[SOURCE[1|2]:]MARKer:POINT {<sample\_number>|MINimum|MAXimum}

## Trigger Setup

TRIGger[1|2]

TRIGger[1|2]:COUNT {<number>|MINimum|MAXimum|DEFAULT}

TRIGger[1|2]:COUNT? [{MINimum|MAXimum}]

TRIGger[1|2]:DELAY {<seconds>|MINimum|MAXimum}

TRIGger[1|2]:DELAY? [{MINimum|MAXimum}]

TRIGger[1|2]:LEVEL {<level>|MINimum|MAXimum}

TRIGger[1|2]:LEVEL? [{MINimum|MAXimum}]

TRIGger[1|2]:SLOPe {POSitive|NEGative}

TRIGger[1|2]:SLOPe?

TRIGger[1|2]:SOURCE {IMMEDIATE|EXTERNAL|TIMER|BUS}

TRIGger[1|2]:SOURCE?

TRIGger[1|2]:TIMER {<seconds>|MINimum|MAXimum}

TRIGger[1|2]:TIMER? [{MINimum|MAXimum}]

## State Storage

MEMory:NSTates?

MEMory:STATE:CATalog?

MEMory:STATE:DElete {0|1|2|3|4}

MEMory:STATE:NAME {0|1|2|3|4} [, <name>]

MEMory:STATE:NAME? {0|1|2|3|4}

MEMory:STATE:RECall:AUTO {ON|1|OFF|0}

MEMory:STATE:RECall:AUTO?

MEMory:STATE:VALid? {0|1|2|3|4}

## Mass Memory

MMEMory:CATalog[:ALL]? [<folder>]

MMEMory:CATalog:DATA:ARbitrary? [<folder>]

MMEMory:CATalog:STATe? [<folder>]

MMEMory:CDIRectory <folder>

MMEMory:CDIRectory?

MMEMory:COpy <file1>,<file2>

MMEMory:COpy:SEQuence <source>,<destination>

MMEMory:DELeTe <file>

MMEMory:DOWNload:DATA <binary\_block>

MMEMory:DOWNload:FNAME <filename>

MMEMory:LOAD:ALL <filename>

MMEMory:LOAD:DATA[1|2] <filename>

MMEMory:LOAD:LIST[1|2] <filename>

MMEMory:LOAD:STATe <filename>

MMEMory:MDIRectory <folder>

MMEMory:MOVE <file1>,<file2>

MMEMory:RDIRectory <folder>

MMEMory:STORe:ALL <filename>

MMEMory:STORe:DATA[1|2] <filename>

MMEMory:STORe:LIST[1|2] <filename>

MMEMory:STORe:STATe <filename>

MMEMory:UPLoad? <filename>

## Display

DISPlay {ON|1|OFF|0}

DISPlay?

DISPlay:TEXT "<string>"

DISPlay:TEXT?

DISPlay:TEXT:CLear

DISPlay:UNIT:ARBRate {SRATe|FREQuency|PERiod}

DISPlay:UNIT:PULse {WIDTh|DUTY}

DISPlay:UNIT:RATE {FREQuency|PERiod}

DISPlay:UNIT:SWEep {STARtstop|CENTerspan}

DISPlay:UNIT:VOLT {AMPLitudeoff|HIGHlow}

DISPlay:VIEW {STANdard|TEXT|GRAPh|DUAL}

## Screen Shots

HCOPy:SDUMp:DATA?

HCOPy:SDUMp:DATA:FORMat {PNG|BMP}

HCOPy:SDUMp:DATA:FORMat?

## LXI

LXI:IDENtify[:STATE] {ON|1|OFF|0}

LXI:IDENtify[:STATE]?

LXI:MDNS:ENABle {ON|1|OFF|0}

LXI:MDNS:ENABle?

LXI:MDNS:HNAME:RESolved?

LXI:MDNS:SNAME:DESired <name>

LXI:MDNS:SNAME:DESired?

LXI:MDNS:SNAME[:RESolved]?

LXI:RESet

LXI:REStart

## Remote Interface Configuration

SYSTem:COMMunicate:ENABle {ON|1|OFF|0}, <interface>

SYSTem:COMMunicate:ENABle? <interface>

SYSTem:COMMunicate:GPIB:ADDRes <address>

SYSTem:COMMunicate:GPIB:ADDRes?

SYSTem:COMMunicate:LAN:CONTRol?

SYSTem:COMMunicate:LAN:DHCP {ON|1|OFF|0}

SYSTem:COMMunicate:LAN:DHCP?

SYSTem:COMMunicate:LAN:DNS[1|2] "<address>"

SYSTem:COMMunicate:LAN:DNS[1|2]? [{CURRENT|STATIC}]

SYSTem:COMMunicate:LAN:DOMain?

SYSTem:COMMunicate:LAN:GATeway "<address>"

SYSTem:COMMunicate:LAN:GATeway? [{CURRENT|STATIC}]

SYSTem:COMMunicate:LAN:HOSTname "<name>"

SYSTem:COMMunicate:LAN:HOSTname? [{CURRENT|STATIC}]

SYSTem:COMMunicate:LAN:IPADdress "<address>"

SYSTem:COMMunicate:LAN:IPADdress? [{CURRENT|STATIC}]

SYSTem:COMMunicate:LAN:MAC?

SYSTem:COMMunicate:LAN:SMASk "<mask>"

SYSTem:COMMunicate:LAN:SMASk? [{CURRENT|STATIC}]

SYSTem:COMMunicate:LAN:TELNet:PRoMpt "<string>"

SYSTem:COMMunicate:LAN:TELNet:PRoMpt?

SYSTem:COMMunicate:LAN:TELNet:WMESsage "<string>"

SYSTem:COMMunicate:LAN:TELNet:WMESsage?

SYSTem:COMMunicate:LAN:UPDate

SYSTem:COMMunicate:LAN:WINS[1|2] "<address>"

SYSTem:COMMunicate:LAN:WINS[1|2]? [{CURRENT|STATIC}]

## System

SYSTem:BEEPer[:IMMediate]

SYSTem:BEEPer:STATe {ON|1|OFF|0}

SYSTem:BEEPer:STATe?

SYSTem:CLICk:STATe{ON|1|OFF|0}

SYSTem:CLICk:STATe?

SYSTem:DATE <yyyy>, <mm>, <dd>

SYSTem:DATE?

SYSTem:ERRor?

SYSTem:LICense:CATalog?

SYSTem:LICense:DELeTe "<option\_name>"

SYSTem:LICense:DELeTe:ALL

SYSTem:LICense:DESCRiption? "<option\_name>"

SYSTem:LICense:ERRor?

SYSTem:LICense:ERRor:COUNT?

SYSTem:LICense:INSTall "<file>"

SYSTem:LICense:INSTall? "<option>"

SYSTem:LOCK:NAME?

SYSTem:LOCK:OWNer?

SYSTem:LOCK:RELease

SYSTem:LOCK:REQuest?

SYSTem:SECurity:IMMediate

SYSTem:TIME <hh>, <mm>, <ss>

SYSTem:TIME?

SYSTem:VERSion?

## Phase

[SOURce[1|2]:]PHASe {<angle>|MINimum|MAXimum|DEFAULT}

[SOURce[1|2]:]PHASe? [{MINimum|MAXimum}]

[SOURce[1|2]:]PHASe:ARBitrary {<angle>|MINimum|MAXimum}

[SOURce[1|2]:]PHASe:MODulation {<angle>|MINimum|MAXimum}

[SOURce[1|2]:]PHASe:MODulation?

[SOURce[1|2]:]PHASe:REFerence

[SOURce[1|2]:]PHASe:SYNChronize

[SOURce[1|2]:]PHASe:UNLock:ERRor:STATe {ON|1|OFF|0}

[SOURce[1|2]:]PHASe:UNLock:ERRor:STATe?

## Reference oscillator

ROSCillator:SOURce {INTernal|EXTernal}

ROSCillator:SOURce?

ROSCillator:SOURce:AUTO {ON|OFF}

ROSCillator:SOURce:AUTO?

ROSCillator:SOURce:CURREnt?

## Calibration

CALibration[:ALL]?

CALibration:COUNT?

CALibration:SECure:CODE <new\_code>

CALibration:SECure:STATe {ON|1|OFF|0} [, <code>]

CALibration:SECure:STATe?

CALibration:SETup <step>

CALibration:SETup?

CALibration:STORE

CALibration:STRing "<string>"

CALibration:STRing?

CALibration:VALue <value>

CALibration:VALue?

## IEEE-488

\*CLS

\*ESE <enable\_value>

\*ESE?

\*ESR?

\*IDN?

\*OPC

\*OPC?

\*OPT?

\*PSC {0|1}

\*PSC?

\*RCL {0|1|2|3|4}

\*RST

\*SAV {0|1|2|3|4}

\*SRE <enable\_value>

\*SRE?

\*STB?

\*TRG

\*TST?

\*WAI

## Status

STATus:OPERation:CONDition?

STATus:OPERation:ENABle <enable\_value>

STATus:OPERation:ENABle?

STATus:OPERation[:EVENT]?

STATus:PRESet

STATus:QUEStionable:CONDition?

STATus:QUEStionable:ENABle <enable\_value>

STATus:QUEStionable:ENABle?

STATus:QUEStionable[:EVENT]?

## Miscellaneous

ABORt

[SOURce[1|2]:]PHASe:ARBitrary {<angle>|MINimum|MAXimum}

[SOURce[1|2]:]PHASe:ARBitrary?

[SOURce[1|2]:]COMBine:FEED {CH1|CH2|NONE}

[SOURce[1|2]:]COMBine:FEED?

FORMat:BORDER {NORMal|SWAPped}

FORMat:BORDER?

INITiate[1|2]:CONTInuous {ON|1|OFF|0}

INITiate[1|2]:CONTInuous?

INITiate:CONTInuous:ALL {ON|1|OFF|0}

INITiate[1|2]::IMMediate]

INITiate[:IMMediate]:ALL

[SOURce[1|2]:]MARKer:CYCLE {<cycle\_num>|MINimum|MAXimum|DEFAULT}

[SOURce[1|2]:]MARKer:CYCLE? [{MINimum|MAXimum}]

INPut:ATTenuation[::STATe] {ON|1|OFF|0}

INPut:ATTenuation[::STATe]?

[SOURce[1|2]:]MARKer:FREQuency {<frequency>|MINimum|MAXimum|DEFAULT}

[SOURce[1|2]:]MARKer:FREQuency? [{MINimum|MAXimum}]

[SOURce[1|2]:]MARKer:POINt {<sample\_number>|MINimum|MAXimum}

[SOURce[1|2]:]MARKer:POINt? [{MINimum|MAXimum}]

[SOURce[1|2]:]TRACk {ON|OFF|INVerted}

TRACk?

UNIT:ANGLe {DEGREE|RADIan|SECond|DEFAULT}

UNIT:ANGLe?

UNIT:ARBitrary:ANGLe {DEGREE|RADIan|SECond|SAMPLE|DEFAULT}

UNIT:ARBitrary:ANGLe?

## Factory Reset State

The following tables show factory default settings. Parameters marked with a bullet (·) are non-volatile, and are not affected by power cycling or \*RST. Other parameters are volatile and reset to the indicated values at power-on or after \*RST.

### NOTE

The power-on/reset state may differ from that shown below if you have enabled power-on state recall mode from the **[System]** menu. See [Instrument State Storage](#).



<b>Output Channel Configuration</b>	
Function	Sine
Tracking	Off
Frequency	1 kHz
Frequency Mode	CW
Frequency Couple State	OFF
Frequency Couple Mode	Ratio
Frequency Couple Ratio	1
Frequency Couple Offset	0
Amplitude	100 mVpp
Offset	0 VDC
Voltage Couple State	OFF
Voltage Limit State	OFF
Voltage Limit High	5 V
Voltage Limit Low	-5 V
Voltage Unit	VPP
Voltage Range	AUTO
State	OFF
Load	50 $\Omega$
Polarity	Normal
Mode (Normal vs. Gated)	Normal
Sync Polarity	Normal
Sync Mode	Normal
<b>Output Channel Configuration</b>	
Sync State	ON
Sync Source	CH1
Trigger Source	CH1
Trigger Slope	Positive
Trigger State	OFF

<b>Noise</b>	
Bandwidth	100 kHz
<b>PRBS</b>	
Data	PN7
Bit Rate	1 kbps
Transition	8.4E-09
<b>Pulse</b>	
Duty Cycle	10%
Period	1 ms
Leading/Trailing Edge	10 ns
Width	0.1 ms
<b>Ramp</b>	
Symmetry	100
<b>Square</b>	
Duty Cycle	50%
Period	1 ms
<b>Arbitrary Waveforms</b>	
Arb	Exponential Rise
Filter	STEP
Sample Rate	40 kSa/sec
Advance	SRATE
Marker Point	Mid point of arb
<b>Amplitude Modulation</b>	
State	OFF
Modulation Source	Internal
Internal Function	Sine
Internal Frequency	100 Hz
Depth	100%
DSSC	OFF
<b>Frequency Modulation</b>	

State	OFF
Modulation Source	Internal
Internal Function	Sine
Internal Frequency	10 Hz
Deviation	100 Hz
<b>FSK Modulation</b>	
State	OFF
Modulation Source	Internal
Internal Rate	10 Hz
Frequency	100 Hz
<b>Phase Modulation</b>	
State	OFF
Modulation Source	Internal
Function	Sine
Frequency	10 Hz
Deviation	180 degrees
<b>BPSK Modulation</b>	
State	OFF
Modulation Source	Internal
Internal Rate	10 Hz
Phase	180 degrees
<b>Pulse Width Modulation</b>	
State	OFF
Modulation Source	Internal
Function	Sine
Frequency	10 Hz
Deviation	1% or 1E-5 sec, depending on how specified
<b>SUM</b>	
State	OFF

Source	Internal
Function	Sine
Frequency	100 Hz
Sum Amplitude	0.10%
<b>Phase Control</b>	
Phase Adjust	0 degrees
Unlock Error State	OFF
Units	degrees
<b>Reference Oscillator</b>	
Source Auto	ON
Source	Internal
<b>Burst</b>	
State	OFF
Gate Polarity	Normal
Mode	Triggered
Cycles	1
Period	10 ms
Phase	0 degrees
Marker Cycle	2
<b>Sweep</b>	
State	OFF
Spacing	Linear
Start Freq	100 Hz
Stop Freq	1 kHz
Center Freq	550 Hz
Span	900 Hz
Marker Freq	500 Hz
Sweep Time	1 sec
Hold Time	0 sec
Return Time	0 sec

<b>List</b>	
Frequency	100, 1000, 550 Hz
Points	3
Dwell	1 sec
<b>Trigger</b>	
Delay	0 sec
Slope	Positive
Source	Immediate
Timer	1 sec
Init Continuous	ON
Count	1
<b>Channel Independent Trigger Configuration</b>	
Init Continuous All	ON
<b>Miscellaneous</b>	
Format Byte Order	Normal
Combine Feed	NONE
<b>The following items do not relate to channel configuration.</b>	
<b>Display</b>	
State	ON
Text	""
Hcopy Format	PNG
<b>Remote Interface Communication</b>	
GPIB Address •	10
DHCP •	Enabled
IP Address static •	169.254.5.21
Subnet Mask static •	255.255.0.0
Gateway static •	0.0.0.0

DNS primary server •	0.0.0.0
DNS secondary server •	0.0.0.0
Hostname static •	"A-33xxxx-nnnnn" or "A-33xxxx-nnnnn", where xxxx is the last three digits of the model number, and nnnnn is the last 5 digits of the instrument's serial number
Telnet Prompt •	33xxxx>, where xxxx is the last four digits of the model number.
Telnet Welcome Message •	Welcome to Keysight's 33xxxx Waveform Generator, where xxxx is the last four digits of the model number.
WINS primary server •	0.0.0.0
WINS secondary server •	0.0.0.0
<b>System</b>	
Beep State	ON
Power Down Recall •	OFF
<b>LXI</b>	
Identify	OFF
<b>Calibration</b>	
Calibration State	Secured

**NOTE**

The instrument uses LAN port 5024 for SCPI Telnet sessions, and port 5025 for SCPI Socket sessions.

## SCPI Error Messages

The instrument returns error messages in accord with the SCPI standard.

- Up to 20 command syntax or hardware errors can be stored in each interface-specific error queue (one each for GPIB, USB, VXI-11, and Telnet/Sockets.) Errors appear in the error queue of the I/O session that caused the error.
- The instrument beeps once each time an error is generated (unless disabled by **SYSTem:BEEPer:STATe OFF**). The front panel **ERROR** annunciator turns on when one or more errors are in the error queue.
- A special global error queue holds all power-on and hardware-related errors (for example, overtemperature).

- Error retrieval is first-in-first-out (FIFO), and errors are cleared as you read them. Once you have read all interface-specific errors, the errors in the global error queue are retrieved. When you have read all errors from the global error queue, the **ERROR** annunciator turns off.
- If more than 20 errors have occurred, the last error stored in the queue (the most recent error) is replaced with -350,"Error queue overflow". No additional errors are stored until you remove errors from the queue. If no errors have occurred when you read the error queue, the instrument responds with +0,"No error".
- The front panel reports errors from all I/O sessions and the global error queue. To read the error queue from the front panel, press the [**System**] button, then the **Help** softkey. Then select "View remote command error queue" in the Help menu.
- Error conditions are also summarized in the Status Byte Register. See [Status Subsystem Introduction](#) for details
- The interface-specific error queues are cleared by power cycles and **\*CLS**. The error queue is not cleared by **\*RST**.

- **SCPI:**

**SYSTem:ERRor?** *Read and clear one error from the queue*

Errors have the following format (the error string may contain up to 255 characters):

-113,"Undefined header"

-315 Configuration memory lost; due to firmware revision change

-315 Configuration memory lost; memory corruption detected

-314 Save/recall memory lost; due to firmware revision change

-314 Save/recall memory lost; memory corruption detected

-313 Calibration memory lost

-313 Calibration memory lost; due to firmware revision change

-313 Cannot read file; due to corrupt data

-313 Cannot read file; due to file revision change

-313 Invalid number of channels for operation

-310 System error; internal software error

-310 System error; out of memory

-310 System error; software initialization failed

-292 Referenced name does not exist

-257 File name error;

access denied

drive name missing or not recognized

file or folder already exists  
file too large  
folder is default folder  
folder not empty  
invalid character in name  
not a folder name  
path is a folder name  
path name missing  
path too long  
relative path not allowed  
unknown file extension

-256 File or folder name not found

-254 Media full

-252 Missing media

-250 Mass storage error: file read/write error

-241 Hardware missing

-241 Hardware missing; Command not valid in one channel instrument.

-240 Hardware error; GPIB interface failed

-230 Data corrupt or stale

-222 Data out of range;

- AM depth
- amplitude
- arb frequency
- arb period
- burst count
- burst count limited by length of burst
- burst period
- burst period limited by length of burst
- cannot combine channel with itself. Combine disabled
- duty cycle
- duty cycle limited by frequency



FM deviation  
FM deviation limited by maximum frequency  
FM deviation limited by minimum frequency  
frequency  
frequency in burst mode  
frequency in FM  
high level limited by high soft limit  
high level limited by low level  
high level limited by low soft limit  
high limit value limited by high signal level  
large period limits minimum pulse width  
low level limited by high level  
low level limited by high soft limit  
low level limited by low soft limit  
low limit value limited by low signal level  
marker confined to burst cycles  
marker confined to sweep span  
offset  
period  
PRBS edge time  
PRBS edge time limited by bit rate  
pulse duty cycle limited by period  
pulse edge at maximum  
pulse edge at minimum  
pulse edge time  
pulse edge time limited by duty cycle  
pulse edge time limited by period  
pulse edge time limited by width  
pulse frequency  
pulse period  
pulse width

pulse width limited by period  
PWM deviation  
PWM deviation limited by pulse parameters  
ramp frequency  
ramp Symmetry  
Sample rate  
sample rate clipped to lower limit  
sample rate clipped to upper limit  
square edge time  
square edge time limited by duty cycle  
square edge time limited by period  
square edge time limited by width  
square period  
square width  
sum amplitude limited by channel or combine amplitudes  
sum amplitude value clipped to lower limit  
sweep time  
Track exceeds limits on channel 1. Tracking disabled  
Track exceeds limits on channel 2. Tracking disabled  
trigger count clipped to lower limit  
trigger count clipped to upper limit  
trigger delay  
trigger delay clipped to lower limit  
trigger delay clipped to upper limit  
trigger delay limited by length of burst  
trigger level clipped to lower limit (33600 Series only)  
trigger level clipped to upper limit (33600 Series only)  
trigger level (33600 Series only)  
trigger timer clipped to lower limit  
trigger timer clipped to upper limit  
trigger timer limited by length of burst

user frequency

USER setting only valid for channel 1

value clipped to dwell time's lower limit

value clipped to dwell time's upper limit

value clipped to lower limit

value clipped to sweep time's lower limit

value clipped to upper limit

value limited due to coupling

-222 List Data out of range; Arb frequency : Mode is changed to Normal (33600 Series only)

-222 List Data out of range; Pulse frequency : Mode is changed to Normal

-222 List Data out of range; Ramp frequency : Mode is changed to Normal

-222 List Data out of range; Sine frequency : Mode is changed to Normal

-222 List Data out of range; Square frequency : Mode is changed to Normal

-222 List Data out of range; User frequency : Mode is changed to Normal

-221 Setting the advance mode to trigger forced the trigger source to external.

-221 Setting the Arb Filter OFF changed the maximum sample rate value to 6.25e7.

-221 Setting the trigger source changed the arb advance mode.

-221 Settings conflict;

50V input range not compatible with 50 ohm input impedance; impedance set to 1 Mohm

AM depth forced amplitude change

AM turned off by selection of other mode or modulation

amplitude changed due to function

amplitude changed due to offset

amplitude units changed to Vpp due to high-Z load

amplitude units changed to Vpp, dBm and Vrms not applicable to arb sequences

amplitude units unchanged, dBm and Vrms not applicable to arb sequences

arb advance changed to SRATE due to filter (33600 Series only)

arb advance changed to SRATE due to mode

arb voltage reduced due to output load or limits

Balance gain limited due to amplitude.

Balance offset changed due to amplitude  
both edge times decreased due to period  
both edge times decreased due to pulse duty cycle  
both edge times decreased due to pulse width  
BPSK turned off by selection of other mode or modulation  
burst count reduced to fit entire burst  
Burst mode has caused output phase to be set to zero degrees  
burst period increased to fit entire burst  
burst phase inapplicable for arbs larger than 1M. burst phase set to 0 (33500 Series only)  
burst turned off by selection of other mode or modulation  
Cannot combine DC function  
cannot delete state selected and enabled for automatic power-on recall  
Cannot modulate ARB carrier with ARB as modulation function. Modulation turned off.  
Cannot modulate ARB carrier with ARB modulation function. Function unchanged.  
Cannot modulate ARB carrier with USER as modulation function. Modulation turned off.  
Cannot modulate ARB carrier with USER modulation function. Function unchanged.  
Cannot modulate by a two-channel Arb  
Cannot modulate Noise carrier with Noise as modulation function. Modulation turned off.  
Cannot modulate Noise carrier with Noise modulation function. Function unchanged.  
Cannot modulate PRBS carrier with PRBS as modulation function. Modulation turned off.  
Cannot modulate PRBS carrier with PRBS modulation function. Function unchanged.  
Cannot modulate USER carrier with ARB as modulation function. Modulation turned off.  
Cannot modulate USER carrier with ARB modulation function. Function unchanged.  
Cannot modulate USER carrier with USER as modulation function. Modulation turned off.  
Cannot modulate USER carrier with USER modulation function. Function unchanged.  
Cannot select channel as modulating source  
Cannot use filter in advance arb trigger mode. (33600 Series only)  
combine amplitude exceeds limit. Combine disabled  
Combine turned off by selection of DC function  
coupling cannot be ON with this function, coupling turned off  
coupling violates settings, coupling turned off

edge time decreased due to bit rate

external gating not compatible with gate output; gate output disabled

FM deviation cannot exceed carrier

FM deviation exceeds maximum frequency

FM turned off by selection of other mode or modulation

frequency changed for pulse function

frequency changed for sine function (33600 Series only)

frequency changed for square function (33600 Series only)

frequency forced duty cycle change

frequency made compatible with burst mode (33500 Series only)

frequency reduced for ramp function

frequency reduced for user function

FSK turned off by selection of other mode or modulation

Function or modulation source cannot be USER. Tracking disabled

Function selection limited the FSK frequency.

Gated output not available for gated burst. Output mode changed to normal.

high level changed due to low level

high limit less than low limit. Limits disabled

infinite burst changed trigger source to BUS

input threshold voltage > input range; threshold clipped to range

leading edge time decreased due to period

leading edge time decreased due to pulse width

leading edge times decreased due to pulse duty cycle

limited frequency to 1MHz when sync mode carrier, burst ON, and function sine (33500 Series only)

list turned off by selection of other mode or modulation

low level changed due to high level

low reference >= high reference

marker forced into sweep span

marker off forced sync to normal mode

marker on forced sync to marker mode

marker point changed to fit arb length  
modulation frequency made compatible with modulation shape  
must stop operation to update trigger count  
must stop operation to update trigger delay  
not able to adjust phase for arb < 64 samples (33600 Series only)  
not able to adjust phase in this function  
not able to adjust phase in this mode  
not able to burst DC, burst turned off  
not able to burst this function  
not able to change output load with limits enabled  
not able to list arb, list turned off  
not able to list DC, list turned off  
not able to list noise, list turned off  
not able to list PRBS, list turned off  
not able to list this function  
not able to modulate arb, modulation turned off  
not able to modulate DC, modulation turned off  
not able to modulate noise, modulation turned off  
not able to modulate PRBS, modulation turned off  
not able to modulate this function  
not able to sweep arb, sweep turned off  
not able to sweep DC, sweep turned off  
not able to sweep noise, sweep turned off  
not able to sweep PRBS, sweep turned off  
not able to sweep this function  
offset changed due to amplitude  
offset changed on exit from DC function  
PM turned off by selection of other mode or modulation  
prbs edge time increased due to amplitude (33600 Series only)  
pulse duty cycle and edge times increased due to amplitude (33600 Series only)  
pulse duty cycle decreased due to period

pulse duty cycle increased due to amplitude (33600 Series only)

pulse duty cycle increased due to period

pulse edge times increased due to amplitude (33600 Series only)

pulse width and edge times increased due to amplitude (33600 Series only)

pulse width decreased due to period

pulse width increased due to amplitude (33600 Series only)

pulse width increased due to large period

PWM deviation decreased due to pulse parameters

PWM only available in pulse function

PWM turned off by selection of other mode or modulation

Range hold turned off by selection of new function (33600 Series only)

selected arb is missing, changing selection to default

selecting a sequence turned off modulation

sequences not supported, changing selection to default

signal exceeds high limit. Limits disabled

signal exceeds low limit. Limits disabled

Skew time between channels not available in Burst, Modulation, or Sweep

sum amplitude exceeds limit or range. Sum disabled

SUM turned off by selection of other mode or modulation

Sweep + Hold + Return time larger than trigger TIMER. Trig timer increased.

Sweep + Hold + Return time max (8000s) limited time setting.

Sweep + Hold + Return time max (8000s) limited time setting.

Sweep + Hold + Return time too large for IMM or TIMER trigger. Sweep turned off.

Sweep + Hold + Return time too large for IMM or TIMER trigger. Trig source unchanged.

Sweep time reduced due to log sweep setting.

sweep turned off by selection of other mode or modulation

Tracking turned off by selection of USER function or modulation source

trailing edge decreased due to leading edge

trailing edge time decreased due to period

trailing edge time decreased due to pulse width

trailing edge times decreased due to pulse duty cycle

trigger delay reduced to fit entire burst

trigger output connector used by BPSK

trigger output connector used by burst gate

trigger output connector used by FSK

trigger output connector used by trigger external

trigger output disabled

trigger output disabled by trigger external

Trigger source limited the sweep time; value clipped to upper limit

triggered burst not available for noise

turned off infinite burst to allow immediate trigger source

Use FUNC:ARB to select an ARB before selecting ARB as modulation function. Function unchanged.

Use FUNC:ARB to select an ARB before selecting ARB as modulation function. Modulation disabled.

Use FUNC:USER to select a user arb before selecting USER as modulation function. Function unchanged.

Use FUNC:USER to select a user arb before selecting USER as modulation function. Modulation disabled.

-213 INIT ignored

-203 Command protected; Enter calibration password from front panel calibration menu (33500 Series only)

-203 Command protected; instrument must be unsecured (33600 Series only)

-203 Command protected; requires license BWD (33600 Series only)

-203 Command protected; requires license SEC (33600 Series only)

-203 Secure option: Instrument security is unlocked

-115 Invalid parameter; Parameter not supported on one channel instrument

-114 Header suffix out of range

100 Network Error

110 LXI mDNS Error

201 Memory lost: stored state

202 Memory lost: power-on state

203 Memory lost: stored measurements

263 Not able to execute while instrument is measuring



291 Not able to recall state: it is empty  
292 State file size error  
293 State file corrupt  
301 Cannot reset input protection; high voltage present  
305 Not able to perform requested operation  
514 Not allowed  
514 Not allowed; Instrument locked by another I/O session  
521 Communications: input buffer overflow  
522 Communications: output buffer overflow  
532 Not able to achieve requested resolution  
540 Cannot use overload as math reference  
550 Not able to execute command in local mode  
560 No valid external timebase  
561 High voltage present on input channel  
570 DDS Processor is not responding  
580 Reference phase-locked loop is unlocked  
581 Waveform DAC Timing is unlocked (33600 Series only)  
581 Waveform DAC Timing regained lock (33600 Series only)  
582 The DATA controller failed to lock for WFDAC (33600 Series only)  
582 The MU controller failed to lock for WFDAC (33600 Series only)  
582 The SYNC controller failed to lock for WFDAC (33600 Series only)  
600 Internal licensing error  
601 License file corrupt or empty  
602 No valid licenses found for this instrument  
603 Some licenses could not be installed  
604 License not found  
605 License already installed

**NOTE**

Most error codes between 600 and 699 refer to self-test errors. See [Self-Test Procedures](#) for details.

701 Calibration error; security defeated by hardware jumper  
702 Calibration error; calibration memory is secured  
703 Calibration error; secure code provided was invalid

704 Calibration error: secure code too long

705 Calibration error; calibration aborted

706 Calibration error; provided value is out of range

707 Calibration error: computed correction factor out of range

707 Calibration error; signal input is out of range

708 Calibration error: signal measurement out of range

709 Calibration error: no calibration for this function/range

710 Calibration error: full scale correction out of range

710 Self-calibration failed

711 Calibration error: calibration string too long

711 Self-calibration failed

712 Calibration failed

712 Self-calibration failed

715 Self-calibration failed

720 Self-calibration failed

740 Calibration data lost: secure state

741 Calibration data lost: string data

742 Calibration data lost: corrections

748 Calibration memory write failure

770 Nonvolatile arb waveform memory corruption detected

781 Not enough memory to store new arb waveform; bad sectors

781 Not enough memory to store new arb waveform; use DATA:DELETE

782 Cannot overwrite a built-in arb waveform

784 Name of source arb waveform for copy must be VOLATILE

785 Specified arb waveform does not exist

786 Not able to delete a built-in arb waveform

786 Specified arb waveform already exists

787 Not able to delete the currently selected active arb waveform

787 Specified arb not loaded in waveform memory

788 Could not load specified arb; Loaded Built-in default arb

791 Firmware update error; unable to begin download

792 Firmware update error; programming operation failed

793 Firmware update error; data record invalid character  
794 Firmware update error; data record length mismatch  
795 Firmware update error; data record checksum mismatch  
796 Firmware update error; bad checksum for download start  
797 Firmware update error; bad checksum for download complete  
798 Firmware update error; download in progress  
799 Firmware update error; unable to complete download  
800 Firmware update error; invalid programming address  
810 State has not been stored  
850 Calibration error; set up is invalid  
851 Calibration error; set up is out of order  
870 Arb: Text File Format error; invalid format  
871 Arb: Segment name is too long  
872 Arb: File name is too long  
873 Arb: Too many sequence steps  
874 Arb: Too many segments defined  
875 Arb: Too many sequences defined  
876 Arb: Sequence already defined  
877 Arb: Segment not found  
878 Arb: Sequence not found  
879 Arb: Segment edit too large  
880 Arb: Out of memory  
881 Arb: Channel count mismatch  
881 Arb: Values are out of range  
882 Arb: Segment too small  
883 Arb: Error in closing file  
884 Arb: Seek too large  
885 Arb: Arb file cannot be stored as sequence file  
886 Arb: Sequence file cannot be stored as arb file  
887 File name error; not a valid extension  
888 Arb: Could not create built in arb directory

889 Arb: Could not copy built in arb

890 enable combine forced tracking off

891 enable coupling forced tracking off

892 enable tracking forced coupling off

893 enable tracking forced combine off

894 Enable tracking forced range hold off (33600 Series only)



## Service and Repair - Introduction

This section contains basic service information for your instrument.

### Types of Service Available

#### Cleaning

#### Electrostatic Discharge (ESD) Precautions

Additional service information is found here:

#### Block Diagram - 33500 Series

#### Block Diagram - 33600 Series

#### Power Supplies - 33500 Series

#### Power Supplies - 33600 Series

#### Troubleshooting - 33500 Series

#### Troubleshooting - 33600 Series

#### Self-Test Procedures

#### Replaceable Parts

#### Disassembly - 33500 Series

#### Disassembly - 33600 Series

#### Battery Replacement

#### Installing the Optional GPIB Interface

## Types of Service Available

If your instrument fails during the warranty period, Keysight Technologies will repair or replace it under the terms of your warranty. After your warranty expires, Keysight offers repair services at competitive prices.

### Extended Service Contracts

Many Keysight products have optional service contracts that extend coverage after the standard warranty expires.

### Obtaining Repair Service (Worldwide)

To obtain service for your instrument, [contact your nearest Keysight Technologies Service Center](#). They will arrange to have your unit repaired or replaced, and can provide warranty or repair-cost information where applicable. Ask the Keysight Technologies Service Center for shipping instructions, including what components to ship. Keysight recommends that you retain the original shipping carton for return shipments.

## Repackaging for Shipment

To ship the unit to Keysight for service or repair:

- Attach a tag to the unit identifying the owner and indicating the required service or repair. Include the model number and full serial number.
- Place the unit in its original container with appropriate packaging material.
- Secure the container with strong tape or metal bands.
- If the original shipping container is unavailable, use a container that will ensure at least 10 cm (4 in.) of compressible packaging material around the entire instrument. Use static-free packaging materials.

Keysight suggests that you always insure shipments.

## Cleaning

Clean the outside of the instrument with a soft, lint-free cloth slightly dampened with water only. Do not use detergent or any form of spray. Disassembly is not required or recommended for cleaning.

## Electrostatic Discharge (ESD) Precautions

Almost all electrical components can be damaged by electrostatic discharge (ESD) during handling. Component damage can occur at electrostatic discharge voltages as low as 50 V.

The following guidelines will help prevent ESD damage during service operations:

- Disassemble instruments only in a static-free work area.
- Use a conductive work area to reduce static charges.
- Use a conductive wrist strap to reduce static charge accumulation.
- Minimize handling.
- Keep replacement parts in original static-free packaging.
- Remove all plastic, foam, vinyl, paper, and other static-generating materials from the immediate work area.
- Use only anti-static solder suckers.

## Introduction to Calibration – 33500 Series

This chapter contains procedures for verifying the instrument's performance and adjustment (calibration).

The instrument uses closed-case electronic calibration; no internal mechanical adjustments are required. The instrument calculates correction factors based on input reference values that you set and stores correction factors in non-volatile memory until the next calibration adjustment is performed. This data is not changed by cycling power or \*RST.

## Keysight Technologies Calibration Services

Your local Keysight Technologies Service Center offers low-cost recalibration. The service center uses automated calibration systems that allow Keysight to provide calibration at competitive prices.

## Calibration Table of Contents

The section includes the following sections:

### Calibration Overview

- Calibration Interval
- Adjustment is Recommended
- Time Required for Calibration
- Automating Calibration Procedures
- Recommended Test Equipment
- Test Considerations
- Calibration Count
- Calibration Message

### Calibration Security

### Performance Verification Tests

- Self-Test
- Quick Performance Check
- Performance Verification Tests
- Amplitude and Flatness Verification Procedures

### Internal Timebase Verification

### AC Amplitude (high-impedance) Verification

### DC Offset Voltage Verification

### -8 dB Range Flatness Verification

### -24 dB Range Flatness Verification



## Service and Repair - Introduction

General Calibration/Adjustment Procedure

Aborting a Calibration in Progress

Sequence of Adjustments

Self-Test

Frequency (Internal Timebase) Adjustment

Internal ADC Adjustment

Self Calibration Adjustment

Output Impedance Adjustment

AC Amplitude (high-impedance) Adjustment

-24 dB Range Flatness Adjustment

-8 dB Range Flatness Adjustment

Adjust Channel 2 (if necessary)

- Self Calibration Adjustment (Channel 2)
- Output Impedance Adjustment (Channel 2)
- AC Amplitude (high-impedance) Adjustment (Channel 2)
- -24 dB Range Flatness Adjustment (Channel 2)
- -8 dB Range Flatness Adjustment (Channel 2)

Calibration Errors

Next Calibration Topic

## Calibration Overview - 33500 Series

This section introduces the instrument's calibration features. For more detailed calibration information, see [Introduction to Calibration](#).

### Calibration Interval

The instrument should be calibrated on a regular interval determined by the accuracy requirements of your application. A one-year interval is adequate for most applications. Accuracy specifications are warranted only if adjustment is made at regular calibration intervals. Accuracy specifications are not warranted beyond the one-year calibration interval. Keysight Technologies does not recommend calibration intervals beyond two years for any application.

### Adjustment is Recommended

Whatever calibration interval you select, Keysight Technologies recommends that complete re-adjustment should always be performed at the calibration interval. This ensures that the instrument will remain within specifications for the next calibration interval and provides the best long-term stability. Performance data measured using this method can be used to extend future calibration intervals. Use the Calibration Count to verify that all adjustments have been performed.

### Time Required for Calibration

For incoming instrument verification, do performance verification tests first. Then perform adjustments and re-run the performance verification tests. Each of these steps, if done manually, takes approximately 30 minutes per channel to perform.

The instrument can also be automatically calibrated under computer control. With computer control you can perform the complete calibration procedure and performance verification tests in approximately 30 minutes (one channel) or 60 minutes (two channels) once the instrument is warmed-up (see [Test Considerations](#)).

### Automating Calibration Procedures

You can use programmable test equipment to automate the complete verification and adjustment procedures. You can program each test's instrument configuration over the remote interface. Then enter read-back verification data into a test program and compare the results to the appropriate test limit.

You can also adjust the instrument from the remote interface, which is similar to the front panel procedure. Use a computer to perform the adjustment by first selecting the required function and range on the measurement equipment. Send the calibration value to the instrument and then initiate calibration over the remote interface.

You must [unsecure the instrument](#) before calibration.

A typical programming sequence for a single calibration setup is as follows:

1. **CAL:SETup 2** (configures instrument for calibration step 2)
2. Measure the output frequency with the external frequency counter
3. **CAL:VALue 9.99994321E6** (send the measured value to the instrument)

4. **CAL?** (initiates the calibration adjustment for setup 2)
5. Read **CAL?** query value to determine the failure (+1) or success (+0) of adjustment
6. **CAL:SETup 3** (configures instrument for calibration step 3)

For further information on instrument programming, see [Introduction to SCPI Language](#).

### Recommended Test Equipment

The test equipment recommended for the performance verification and adjustment procedures is listed below. If the exact instrument is not available, substitute calibration standards of equivalent accuracy.

Instrument	Requirements	Recommended Model	Use*
Digital Multimeter (DMM)	ACV, true rms, AC coupled accuracy: $\pm 0.02\%$ to 1 MHz DCV accuracy: 50 ppm resolution: 100 $\mu\text{V}$ Resistance Offset-compensated accuracy: $\pm 0.1 \Omega$	Keysight 3458A	Q, P, T
Precision AC Voltmeter	1000 Hz to 30 MHz, 0.1 Vrms to 2 Vrms ( $-7 \text{ dBm}$ to $+20 \text{ dBm}$ ) accuracy: 0.02 dB resolution: 0.01 dB	Fluke 5790A	Q, P, T
Frequency Counter	accuracy: 0.1 ppm	Keysight 53132A Opt 012 (high stability)	Q, P, T
Oscilloscope	1 GHz 4 Gs/second 50 $\Omega$ input termination	Keysight MSO6104A	T
Adapter	N type (m) to BNC (m)	Keysight E9623A	Q, P, T
Cable (2 required)	Dual banana (m) to dual banana (m)	Keysight 11000-60000	Q, P, T
Cable	RG58, BNC (m) to dual banana OR RG58 coaxial cable with BNC (m) to dual banana adapter	Keysight 11001-60001	Q, P, T
Cable	RG58, BNC (m) to BNC (m)	Keysight 11170C	Q, P, T

\* Q = Quick Verification P = Performance Verification T = Troubleshooting

### Test Considerations

For optimal performance, all procedures should comply with the following recommendations:

- Calibration ambient temperature is stable, between 18 and 28 °C. Ideally, it should be  $23 \pm 1 \text{ }^\circ\text{C}$ .
- Ambient relative humidity is less than 80%.
- One-hour warm-up period before verification or adjustment.
- Measurement cables as short as possible, consistent with the impedance requirements.
- RG-58 or equivalent 50  $\Omega$  cable.

## Calibration Count

You can query the instrument to determine how many calibrations have been performed. The instrument was calibrated at the factory. When you receive your instrument, be sure to read the count to determine its initial value.

- This setting is non-volatile; it will not be changed by power cycling or **\*RST**.
- Because the value increments for each calibration point that stores a value, a complete calibration increases the value by many counts.

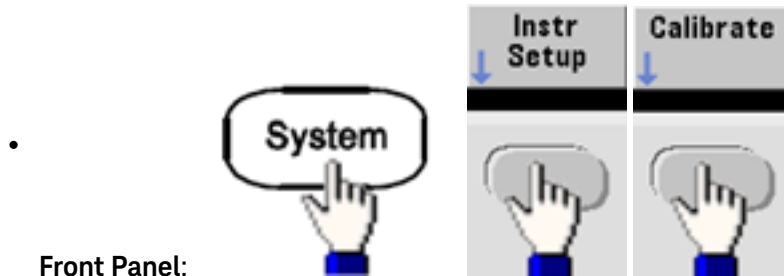

- **SCPI: CAL:COUNT?**

## Calibration Message

You can store one message of up to 40 characters in calibration memory. For example, you can store the date when the last calibration was performed, the date when the next calibration is due, the instrument's serial number, or contact information for your calibration experts.

Unsecure the instrument to record a calibration message. You can read the message from either the front panel or over the remote interface, regardless of whether the instrument is secured.

- Storing a calibration message overwrites any message previously stored.
- This setting is non-volatile; it will not be changed by power cycling or **\*RST**.

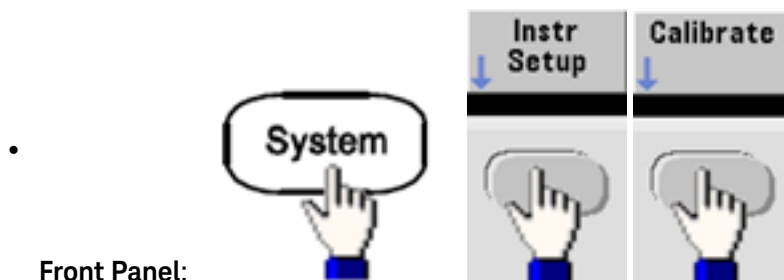

- **SCPI: CAL:STR "Cal Due: 01 August 2012"**

[Previous Calibration Topic](#)   [Next Calibration Topic](#)

## Calibration Security – 33500 Series

This section describes the instrument's calibration security system.

### Security Overview

A security code prevents accidental or unauthorized instrument adjustments. On the 33500 Series, the factory default security code varies by model:

Models	Security Code
33521A and 33522A	AT33520A
335XXB	AT33500

- Once you enter a security code, that code must be used for both front panel and remote operation. If you secure the instrument from the front panel, you must use that same code to unsecure it from the remote interface.
- This setting is non-volatile; it will not be changed by power cycling or \*RST.
- Security code rules:
  - Unquoted string up to 12 characters
  - Must start with letter (A-Z)
  - May contain letters, numbers (0-9) and underscores

- **Front Panel:**



- **SCPI:** `CALibration_SECURITY:STATE`

### Unsecure Instrument Without Security Code

**CAUTION** See [Electrostatic Discharge \(ESD\) Precautions](#) before beginning this procedure.

1. Disconnect power cord and all input and output connections.
2. Disassemble the instrument (see [Disassembly - 33500 Series](#)).

3. Apply a temporary short between pin 1 and pin 6 of the header on the main board, shown below.

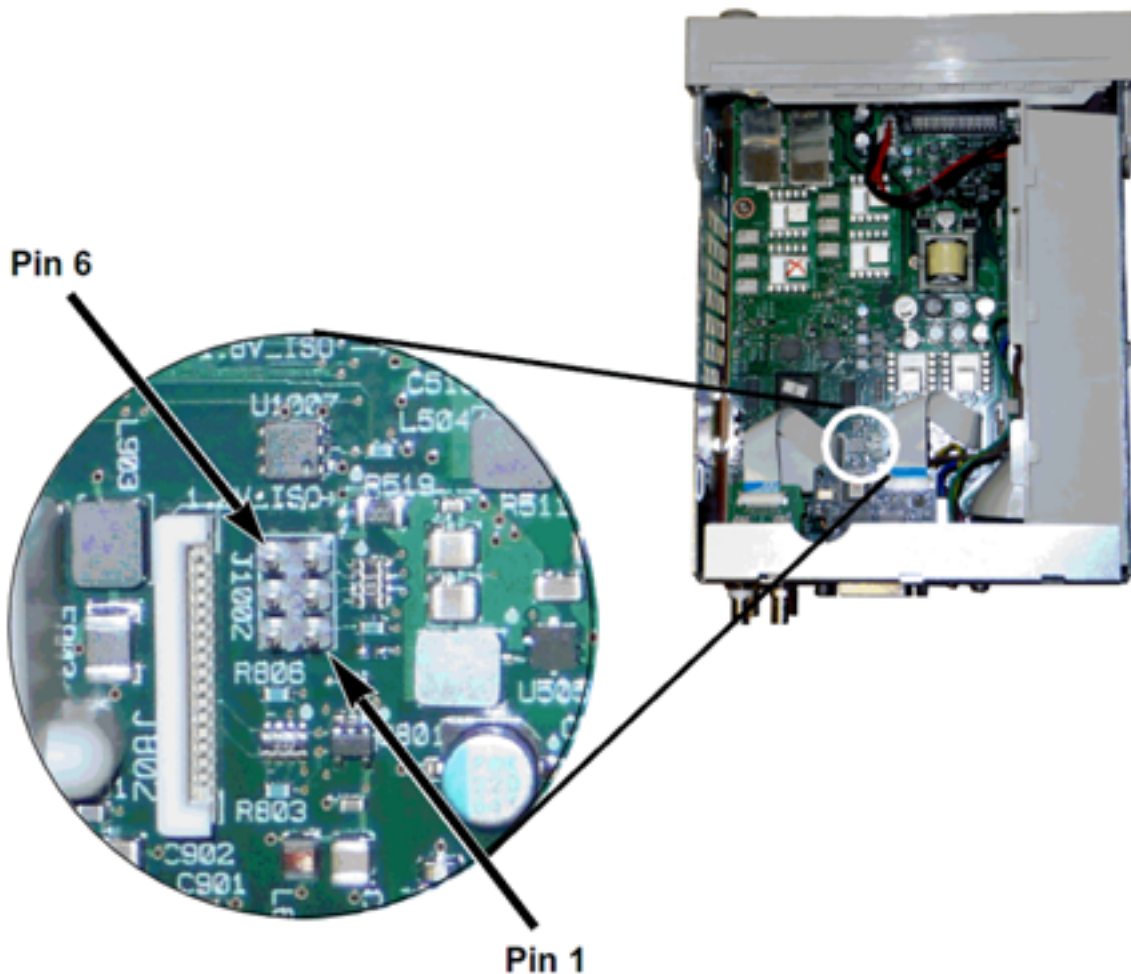

4. Attach power and turn on the instrument.

**WARNING**

Be careful not to touch the power line connections or high voltages on the power supply module. Power is present even if the instrument is turned off.

5. The error queue will show the message "Calibration security has been disabled."

Calibration security is unlocked, with password reset to its factory default value. Calibration count is incremented because jumper was connected during power-up, and error message **+701,"Calibration error; security defeated by hardware jumper"** is issued. Nonvolatile calibration storage is updated to reflect these operations.

6. Turn off the instrument, remove temporary short, and remove power cord.
7. Reassemble the instrument.
8. Enter a new security code as described above, and record the security code in a safe location.

[Previous Calibration Topic](#)   [Next Calibration Topic](#)

## Verification - 33500 Series

The following topics describe the verification portion of the calibration procedure:

- [Performance Verification Tests](#)
- [Internal Timebase Verification](#)
- [AC Amplitude \(high-impedance\) Verification](#)
- [DC Offset Voltage Verification](#)
- [-8 dB Range Flatness Verification](#)
- [-24 dB Range Flatness Verification](#)

[Previous Calibration Topic](#) [Next Calibration Topic](#)

## Performance Verification Tests - 33500 Series

Use the Performance Verification Tests to verify the measurement performance of the instrument. The performance verification tests use the instrument's specifications listed on the product datasheet.

You can perform three levels of performance verification tests:

- **Self-Test** A series of internal verification tests that give high confidence that the instrument is operational.
- **Quick Verification** A combination of the internal self-tests and selected verification tests.
- **Performance Verification Tests** An extensive set of tests that are recommended as an acceptance test when you first receive the instrument or after performing adjustments.

### Self-Test

A brief power-on self-test occurs automatically whenever you turn on the instrument. This limited test assures that the instrument is operational. For details, see [Self-Test Procedures](#).

### Quick Performance Check

The quick performance check is a combination of internal self-test and an abbreviated performance test (specified by the letter Q in the performance verification tests). This test provides a simple method to achieve high confidence in the instrument's ability to functionally operate and meet specifications. These tests represent the absolute minimum set of performance checks recommended following any service activity. Auditing the instrument's performance for the quick check points (designated by a Q) verifies performance for normal accuracy drift mechanisms. This test does not check for abnormal component failures.

To perform the quick performance check, do the following:

1. Perform a [complete self-test](#).
2. Perform only the performance verification tests indicated with the letter Q.

3. If the instrument fails the quick performance check, adjustment or repair is required.

### **Performance Verification Tests**

The performance verification tests are recommended as acceptance tests when you first receive the instrument. The acceptance test results should be compared against the specifications on the product datasheet. After acceptance, you should repeat the performance verification tests at every calibration interval.

If the instrument fails performance verification, adjustment or repair is required.

Adjustment is recommended at every calibration interval. If adjustment is not made, you must guard band, using no more than 80% of the specifications listed in the datasheet, as the verification limits.

### **Amplitude and Flatness Verification Procedures**

The flatness verification procedures use a precision AC voltmeter and a power meter. You may substitute Thermal Voltage Converters (TVCs) to make measurements using appropriate operating procedures and test equipment.

Flatness measurements for the -24 dB and -8 dB attenuator ranges are measured during the verification procedure. Other attenuator ranges are verified as a part of -24 dB and -8 dB attenuation range verification procedures. No separate verification procedure is given for these ranges.

[Previous Calibration Topic](#)   [Next Calibration Topic](#)



## Internal Timebase Verification - 33500 Series

Verifies output frequency accuracy. All output frequencies are derived from a single generated frequency.

1. Connect a frequency counter to the channel 1 output as shown below (the frequency counter input should be terminated at 50  $\Omega$ ).

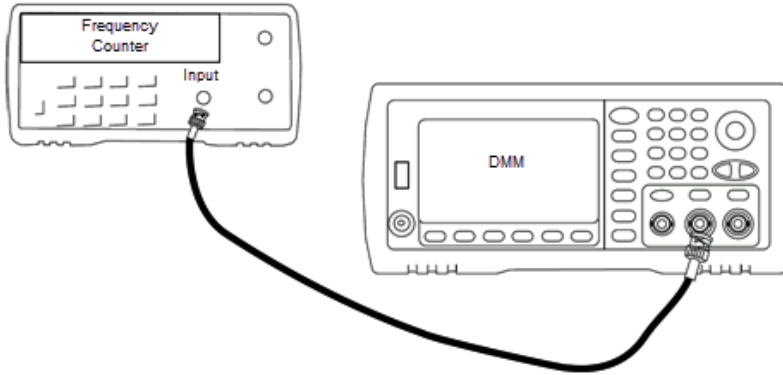

2. Set the instrument to the output described in the table below and measure the output frequency. *Be sure the instrument output is enabled.*

Use	Waveform Generator			Measurement	
	Function	Amplitude	Frequency	Nominal	Error*
Q	Sine	1.00 Vpp	10.0000000 MHz	10.000 MHz	$\pm 10$ Hz

\* With the **optional high-stability OCXO timebase**, the measurement error is  $\pm 1$  Hz.

3. Compare the measured value to the test limits shown in the table.

[Previous Calibration Topic](#)   [Next Calibration Topic](#)

## AC Amplitude (high-impedance) Verification - 33500 Series

Checks AC amplitude output accuracy at 1 kHz frequency using each attenuator.

1. Set the DMM to measure Vrms. Connect the DMM to the channel output as shown below.

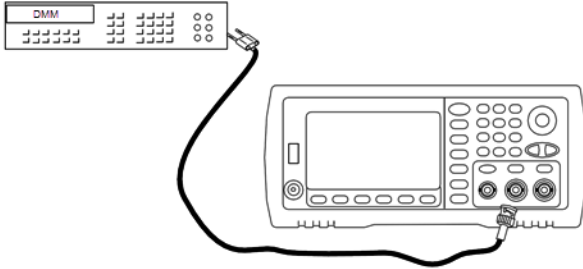

2. Set the instrument to each output in the table below and measure the output voltage with the DMM. Be sure the output impedance is set to High-Z and the output is enabled.

Use	Waveform Generator				Measurement	
	Output Setup	Function	Frequency	Amplitude	Nominal	Error*
Q	High Z**	Sine	1.000 kHz	400.0 mVrms	400.0 mVrms	±0.004707 Vrms
Q	High Z	Sine	1.000 kHz	400.0 mVrms	400.0 mVrms	±0.004707 Vrms
Q	High Z	Sine	1.000 kHz	1.00 Vrms	1.00 Vrms	±0.010707 Vrms
Q	High Z	Sine	1.000 kHz	2.500 Vrms	2.500 Vrms	±0.025707 Vrms
Q	High Z	Sine	1.000 kHz	7.000 Vrms	7.000 Vrms	±0.070707 Vrms

\* Based upon 1% of setting ±1 mVpp (50 Ω); converted to Vrms for High-Z.

\*\* Use the following sequence to set this output:

- a. Set amplitude to 400.0 mVrms
- b. Set DC Offset to 1.0 VDC
- c. Set Auto-Range to OFF
- d. Set DC Offset Voltage to 0.0 VDC
- e. After the measurement, set autorange ON for remaining measurements.

3. Compare the measured value to the test limits shown in the table.
4. Two-channel instruments only: connect DMM to channel 2 output and repeat steps 2 and 3.

[Previous Calibration Topic](#)   [Next Calibration Topic](#)

## DC Offset Voltage Verification - 33500 Series

Checks the DC Offset Voltage on two attenuator ranges:

1. Set the DMM to measure DCV. Connect the DMM to the channel output as shown below.

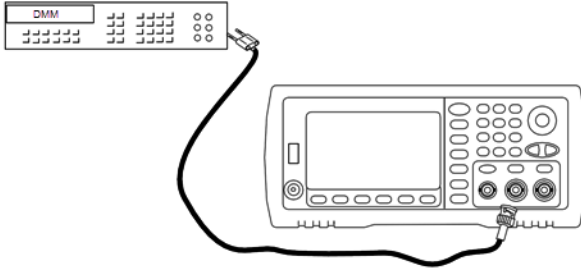

2. Set the instrument to each output in the table below and measure the output voltage with the DMM.

Use	Waveform Generator			Measurement	
	Output Setup	Function	Voltage	Nominal	Error*
Q	High Z	DC	0.0 V	0.0 VDC	±0.002 VDC
Q	High Z	DC	500 mV	0.500 VDC	±0.007 VDC
Q	High Z	DC	10.0 V	10.0 VDC	±0.102 VDC

\* Based upon 1% of setting ±2 mVDC for High-Z.

3. Compare the measured value to the test limits shown in the table.
4. Two-channel instruments only: connect DMM to channel 2 output and repeat steps 2 and 3.

[Previous Calibration Topic](#) [Next Calibration Topic](#)

### -8 dB Range Flatness Verification - 33500 Series

Checks high frequency AC amplitude flatness on the -8 dB attenuator range. Also checks flatness for all other ranges excluding the -24 dB and 0 dB attenuator ranges.

1. Connect a precision AC voltmeter to measure the output amplitude as shown below. Connect the BNC cable to the Wide Band input of the Fluke 5790A. If you are using substitute test equipment, verify that the input impedance is 50  $\Omega$ , because load accuracy directly affects measurement quality.

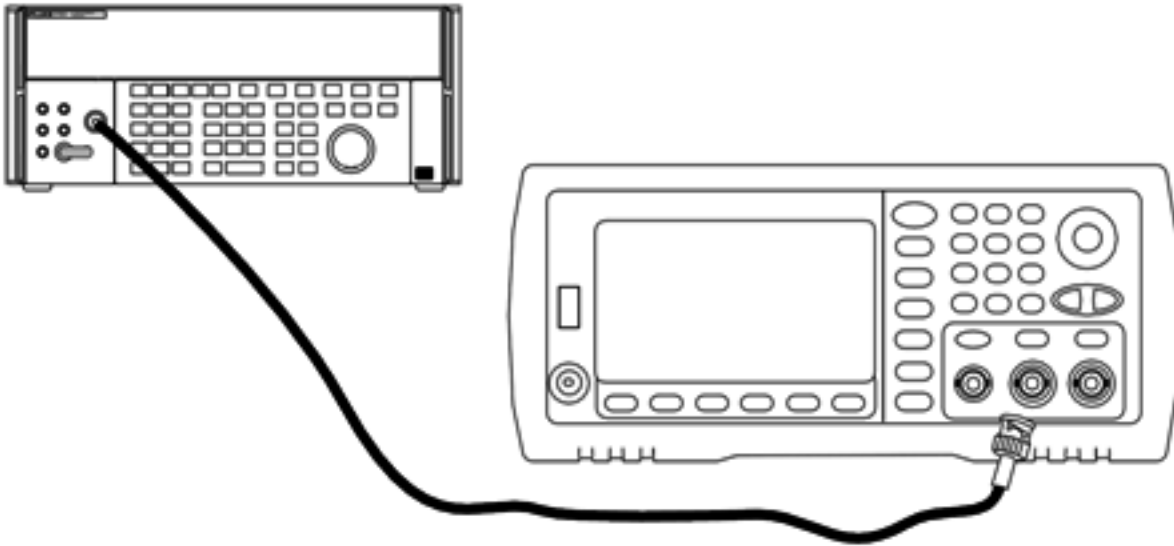

2. Set the precision AC Voltmeter to "Medium, Medium" Digital Filter and Filter Restart.
3. Set the instrument to each output described in the table below and measure the output amplitude with the AC voltmeter. This will become the reference measurement. Set the output impedance to 50  $\Omega$ . Be sure the output is enabled.

Use	Waveform Generator				Measurement	
	Output Load	Function	Amplitude	Frequency	Nominal	Error
Q	50 $\Omega$	Sine	1.200 Vrms	1.000 kHz	1.200 Vrms	$\pm 0.0127$ Vrms

4. Set the measured value in Step 3 to be the reference value on the AC voltmeter.
5. Set the instrument to each output described in the table below and measure the output amplitude relative to the source as a percent with the AC voltmeter. Note that the table also lists the output in dB if you are using a power meter to perform this test.

Use	Waveform Generator				Measurement			
	Output Load	Function	Amplitude	Frequency	Nominal	Error	Nominal	Error

Use	Waveform Generator				Measurement			
	50 $\Omega$	Sine	1.200 Vrms	100.000 kHz	100%	$\pm 1.15\%$	0 dB	$\pm 0.10$ dB
				500.000 kHz		$\pm 1.74\%$		$\pm 0.15$ dB
				1.000 MHz		$\pm 1.74\%$		$\pm 0.15$ dB
Q	50 $\Omega$	Sine	1.200 Vrms	2.000 MHz	100%	$\pm 1.74\%$	0 dB	$\pm 0.15$ dB
	50 $\Omega$	Sine	1.200 Vrms	5.000 MHz	100%	$\pm 1.74\%$	0 dB	$\pm 0.15$ dB
				10.00 MHz		$\pm 3.51\%$		$\pm 0.30$ dB
				15.00 MHz		$\pm 3.51\%$		$\pm 0.30$ dB
				20.00 MHz		$\pm 3.51\%$		$\pm 0.30$ dB
				22.00 MHz (unnecessary for 20 MHz instruments)		$\pm 4.71\%$		$\pm 0.40$ dB
				27.00 MHz (unnecessary for 20 MHz instruments)		$\pm 4.71\%$		$\pm 0.40$ dB
				30.00 MHz (unnecessary for 20 MHz instruments)		$\pm 4.71\%$		$\pm 0.40$ dB

6. Compare the measured value to the test limits shown in the table.
7. Two-channel instruments only: Connect the AC voltmeter to channel 2 and repeat steps 2 through 6.

[Previous Calibration Topic](#) [Next Calibration Topic](#)

### -24 dB Range Flatness Verification - 33500 Series

Checks high frequency AC amplitude flatness on the - 24 dB attenuator range. Also checks flatness for the 0 dB attenuator range.

1. Connect a precision AC voltmeter to measure the output amplitude as shown below. Connect the BNC cable to the Wide Band input of the Fluke 5790A. If you are using substitute test equipment, verify that the input impedance is 50  $\Omega$ , because load accuracy directly affects measurement quality.

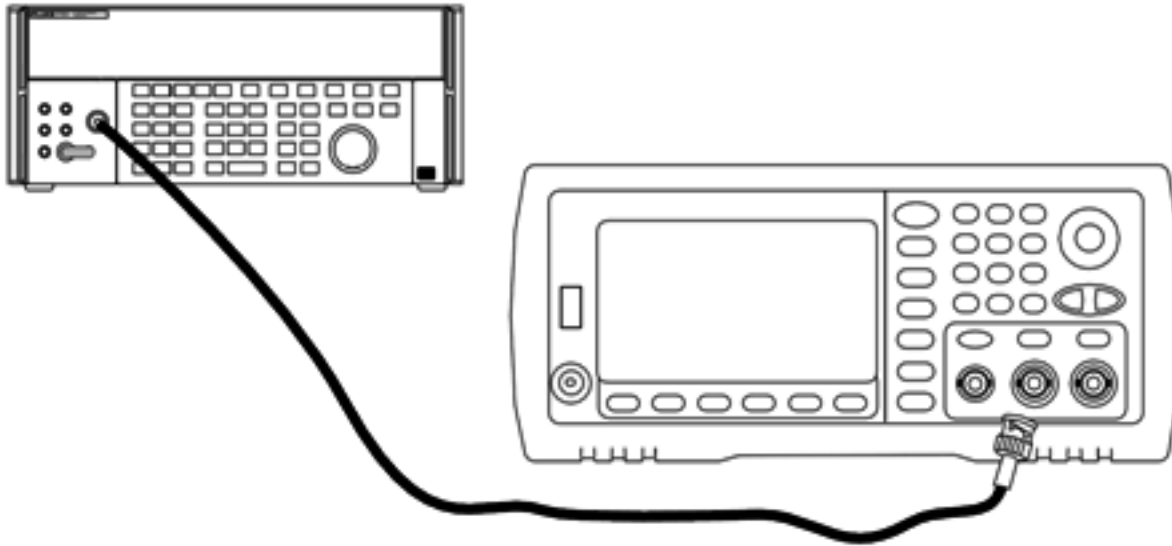

2. Set the precision AC Voltmeter to "Medium, Medium" Digital Filter and Filter Restart.
3. Set the instrument to each output described in the table below and measure the output amplitude with the AC voltmeter. This will become the reference measurement. Set the output impedance to 50  $\Omega$ . Be sure the output is enabled.

Use	Waveform Generator				Measurement	
	Output Load	Function	Amplitude	Frequency	Nominal	Error
Q	50 $\Omega$	Sine	0.190 Vrms	1.000 kHz	0.190 Vrms	$\pm 0.0026$ Vrms

4. Set the measured value in Step 3 to be the reference value on the AC voltmeter.
5. Set the instrument to each output described in the table below and measure the output amplitude relative to the source as a percent with the AC voltmeter. Note that the table also lists the output in dB if you are using a power meter to perform this test.

Use	Waveform Generator				Measurement			
	Output Load	Function	Amplitude	Frequency	Nominal	Error	Nominal	Error

Use	Waveform Generator				Measurement			
	50 $\Omega$	Sine	0.190 Vrms	100.000 kHz	100%	$\pm 1.15\%$	0 dB	$\pm 0.10$ dB
				500.000 kHz		$\pm 1.74\%$		$\pm 0.15$ dB
				1.000 MHz		$\pm 1.74\%$		$\pm 0.15$ dB
Q	50 $\Omega$	Sine	0.190 Vrms	2.000 MHz	100%	$\pm 1.74\%$	0 dB	$\pm 0.15$ dB
	50 $\Omega$	Sine	0.190 Vrms	5.000 MHz	100%	$\pm 1.74\%$	0 dB	$\pm 0.15$ dB
				10.00 MHz		$\pm 3.51\%$		$\pm 0.30$ dB
				15.00 MHz		$\pm 3.51\%$		$\pm 0.30$ dB
				20.00 MHz		$\pm 3.51\%$		$\pm 0.30$ dB
				22.00 MHz (unnecessary for 20 MHz instruments)		$\pm 4.71\%$		$\pm 0.40$ dB
				27.00 MHz (unnecessary for 20 MHz instruments)		$\pm 4.71\%$		$\pm 0.40$ dB
				30.00 MHz (unnecessary for 20 MHz instruments)		$\pm 4.71\%$		$\pm 0.40$ dB

6. Compare the measured value to the test limits shown in the table.
7. Two-channel instruments only: Connect the AC voltmeter to channel 2 and repeat steps 2 through 6.

[Previous Calibration Topic](#)   [Next Calibration Topic](#)

## General Calibration/Adjustment Procedure - 33500 Series

Recommended method for a complete instrument calibration:

1. Read **Test Considerations**.
2. **Perform the verification tests** to characterize the instrument (incoming data).
3. Press [**System** > **Instr Setup** > **Calibrate**. If the instrument is secured from calibration, **unsecure it**.
4. Enter the Setup Number for the procedure being performed. The default setup number is "1" and, from the front panel, the number will increment as the procedures are performed.
5. Select **BEGIN**.
6. For setups that require an input, adjust the value shown in the display to the measured value and select **ENTER VALUE**.
7. The setup automatically advances to the next required value.

To cancel the adjustment procedure, select **CANCEL STEP**. The display will return to the setup number entry.

8. When finished, select **END CAL**.
9. (Optional) Set a new calibration message using the remote interface. The message (up to 40 characters) is stored with the calibration coefficients.
10. Secure the instrument against calibration.
11. Note the new security code and calibration count in the instrument's maintenance records.

[Previous Calibration Topic](#)   [Next Calibration Topic](#)

## Aborting a Calibration in Progress - 33500 Series

Sometimes it may be necessary to abort a calibration in progress. You can abort a calibration at any time by turning off the power or by issuing a remote interface device clear message followed by **\*RST**.

The instrument stores calibration constants at the end of each adjustment procedure. If you lose power, or otherwise abort an adjustment in progress, you will only need to perform the interrupted adjustment procedure again.

### CAUTION

If power is lost when the instrument is attempting to write new calibration constants to memory, you may lose all calibration constants for the function. Typically, upon re-applying power, the instrument will report error **"-313, Calibration Memory Lost"**.

[Previous Calibration Topic](#)   [Next Calibration Topic](#)



## Sequence of Adjustments - 33500 Series

The adjustment sequence in the numbered steps minimizes the number of test equipment setups and connection changes.

You may perform individual adjustments as necessary, but setups 1 through 7 must be performed in order, before any other setup procedure.

[Previous Calibration Topic](#)   [Next Calibration Topic](#)

## Self-Test - 33500 Series

Run self-test to ensure that the instrument is in working order before beginning any additional adjustments.

Be sure to unlock the instrument and follow the requirements listed in [Test Considerations](#) before beginning any adjustments.

1. Press [**System** > **Instr Setup** > **Calibrate**. Enter setup number 1 and select **BEGIN**.

Setup	
1	Performs the self-test. The Main Output is disabled during test.

2. If the instrument fails any self-test, you must repair the instrument before continuing the adjustment procedures.

A complete self-test (\*TST?) takes approximately 15 seconds.

[Previous Calibration Topic](#)   [Next Calibration Topic](#)

## Frequency (Internal Timebase) Adjustment - 33500 Series

The instrument stores a calibration constant that sets the crystal oscillator to put out exactly 10 MHz. The instrument should have been running continuously for 30 minutes prior to this calibration adjustment to ensure timebase stability.

1. Set the frequency counter resolution to better than 0.01 ppm and the input termination to 50 Ω (if your frequency counter does not have a 50 Ω input termination, you must provide an external termination). Make the connections shown below.

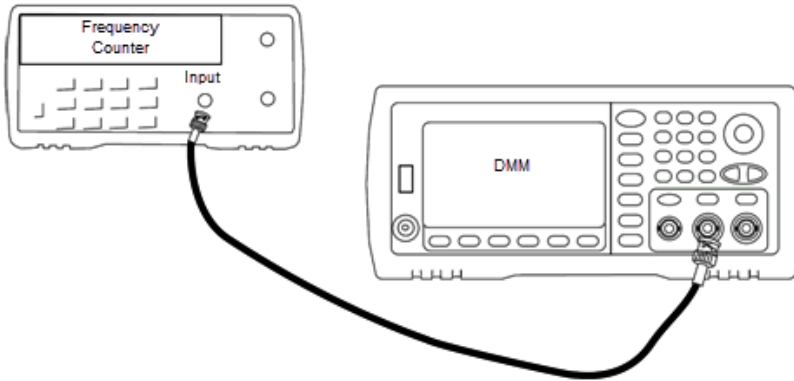

2. Use the frequency counter to measure the output frequency for each setup in the following table.

Setup	Nominal Signal		
	Frequency	Amplitude	
2	<10 MHz	~1 Vpp	Output frequency is slightly less than 10 MHz
3	>10 MHz		Output frequency is slightly more than 10 MHz
4	~10 MHz		Output frequency should be near 10 MHz
5*	10 MHz		Output frequency should be 10 MHz ± 1 ppm

\* Constants are stored after completing this setup.

3. Using the numerical keypad or knob, adjust the displayed frequency at each setup to match the measured frequency. Select **ENTER VALUE**.
4. To proceed:
  - a. If your calibration procedures require you to verify the adjustment just made, exit the calibration menu and perform **Internal Timebase Verification**.
  - b. If you are making all of the adjustments and then verifying the instrument's performance, continue with the next procedure in this section.

[Previous Calibration Topic](#)   [Next Calibration Topic](#)

### Internal ADC Adjustment - 33500 Series

The instrument stores calibration constants related to the gain and offset of the internal ADC. Setup 6 must always be performed before any other amplitude adjustments are attempted. The internal ADC is then used as a source for the calibration constants generated in self calibration (setup 7).

1. Connect the channel 1 output to the instrument's rear panel Modulation Input and DMM as shown below.

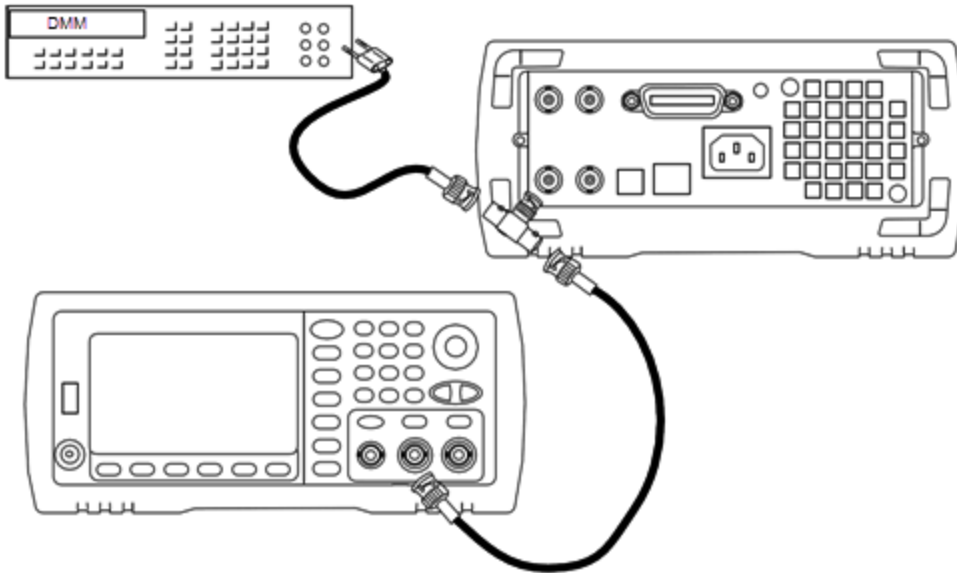

2. Set the DMM to display 5½ digits and set the function to DCV.
3. Enter the following setup.

	Nominal Signal	
Setup	DC level	
6*	~1.0 VDC ±10%	Calibrates the internal ADC.

\* Constants are stored after completing this setup.

4. Use the numeric keypad or knob to enter the value measured on the DMM.

**NOTE**

This setup requires approximately 15 seconds to complete.

5. Disconnect all cables from the instrument.

[Previous Calibration Topic](#)   [Next Calibration Topic](#)

### Self Calibration Adjustment - 33500 Series

1. Enter and begin the following setup.

Setup	
7*	Self-calibration. The output is disabled.

\* Constants are stored after completing this setup.

2. To proceed:

- a. If your calibration procedures require you to verify the adjustment just made, exit the calibration menu and perform **DC Offset Voltage Verification**.
- b. If you are making all of the adjustments and then verifying the instrument's performance, continue with the next procedure in this section.

**NOTE** This setup requires approximately 15 seconds to complete.

[Previous Calibration Topic](#)   [Next Calibration Topic](#)

### Output Impedance Adjustment - 33500 Series

The instrument stores calibration constants for the channels' output impedance. These constants are generated with and without the post-amplifier attenuator.

1. Set the DMM to measure offset-compensated, four-wire Ohms. Set the DMM to use 100 NPLC integration. Connect the Ohms Source and Ohms Sense DMM inputs to the channel output as shown below.

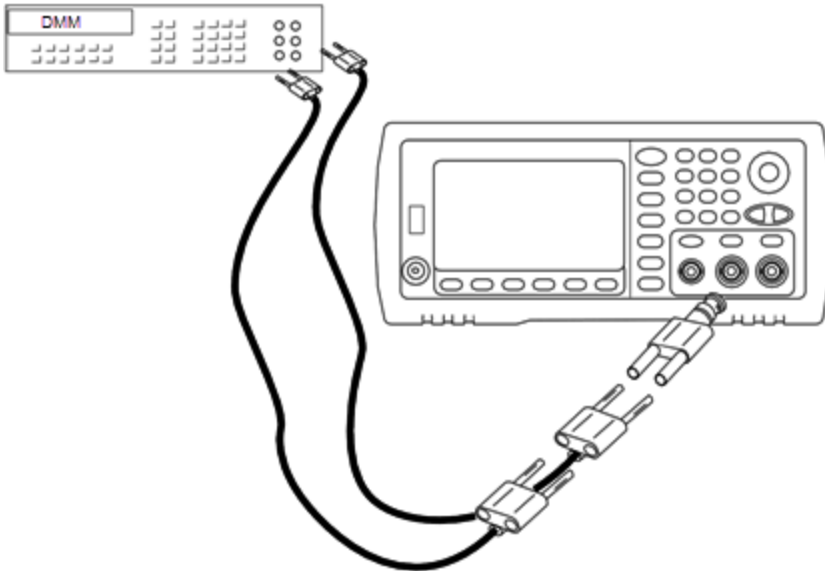

2. Use the DMM to make a 4-wire resistance measurement at the front panel output connector for each setup in the following table. The expected measured value is approximately 50 Ω.

Setup	
8*	-24 dB post-attenuator range
9*	0 dB

\* Constants are stored after completing this setup.

3. Using the numeric keypad or knob, adjust the displayed impedance at each setup to match the measured impedance. Select **ENTER VALUE**.
4. There are no specific operational verification tests for output impedance. Continue with the next adjustment procedure in this section.

[Previous Calibration Topic](#)   [Next Calibration Topic](#)

## AC Amplitude (high-impedance) Adjustment - 33500 Series

The instrument stores a calibration constant for each high-impedance attenuator path. Each path's gain coefficient is calculated using two measurements: one with the waveform DAC at + output and one with waveform DAC at - output. The setups, therefore, must be performed in pairs.

1. Connect the DMM to the channel output as shown below.

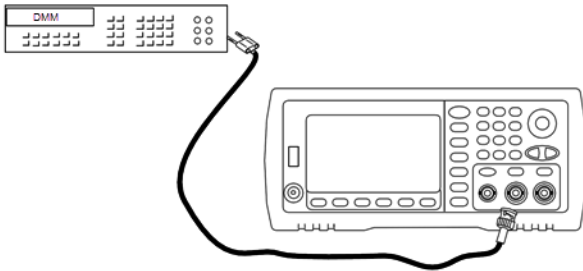

2. Use the DMM to measure the DC voltage at the front panel connector for each setup in the following table.

<b>Setup</b>	<b>Nominal Signal</b>	
	<b>DC Level</b>	
10	+0.0028 V	Output of -72 dB range
11*	-0.0028 V	Output of -72 dB range
12	+0.007 V	Output of -64 dB range
13*	-0.007 V	Output of -64 dB range
14	+0.017 V	Output of -56 dB range
15*	-0.017 V	Output of -56 dB range
16	+0.044 V	Output of -48 dB range
17*	-0.044 V	Output of -48 dB range
18	+0.11 V	Output of -40 dB range
19*	-0.11 V	Output of -40 dB range
20	+0.28 V	Output of -32 dB range
21*	-0.28 V	Output of -32 dB range
22	+0.68 V	Output of -24 dB range
23*	-0.68 V	Output of -24 dB range
24	+1.7 V	Output of -16 dB range
25*	-1.7 V	Output of -16 dB range
26	+4.3 V	Output of -8 dB range
27*	-4.3 V	Output of -8 dB range
28	+10.8 V	Output of 0 dB range
29*	-10.8 V	Output of 0 dB range
30	+0.044V	Output of -48 dB High DC range
31*	-0.044V	Output of -48 dB High DC range
32	+0.11 V	Output of -40 dB High DC range
33*	-0.11 V	Output of -40 dB High DC range
34	+0.28 V	Output of -32 dB High DC range

Setup	Nominal Signal	
	DC Level	
35*	-0.28 V	Output of -32 dB High DC range
36	+0.68 V	Output of -24 dB High DC range
37*	-0.68 V	Output of -24 dB High DC range

\* Constants are stored after completing this setup.

3. Using the numeric keypad or knob, adjust the displayed voltage at each setup to match the measured voltage. Select **ENTER VALUE**.
4. To proceed:
  - a. If your calibration procedures require you to verify this adjustment, exit the calibration menu and perform **AC Amplitude (high-impedance) Verification**.
  - b. If you are making all of the adjustments and then verifying the instrument's performance, continue with the next procedure in this section.

[Previous Calibration Topic](#)   [Next Calibration Topic](#)

### -24 dB Range Flatness Adjustment - 33500 Series

1. Connect a precision AC voltmeter to measure the output amplitude as shown below. Connect the BNC cable to the Wide Band input of the Fluke 5790A.

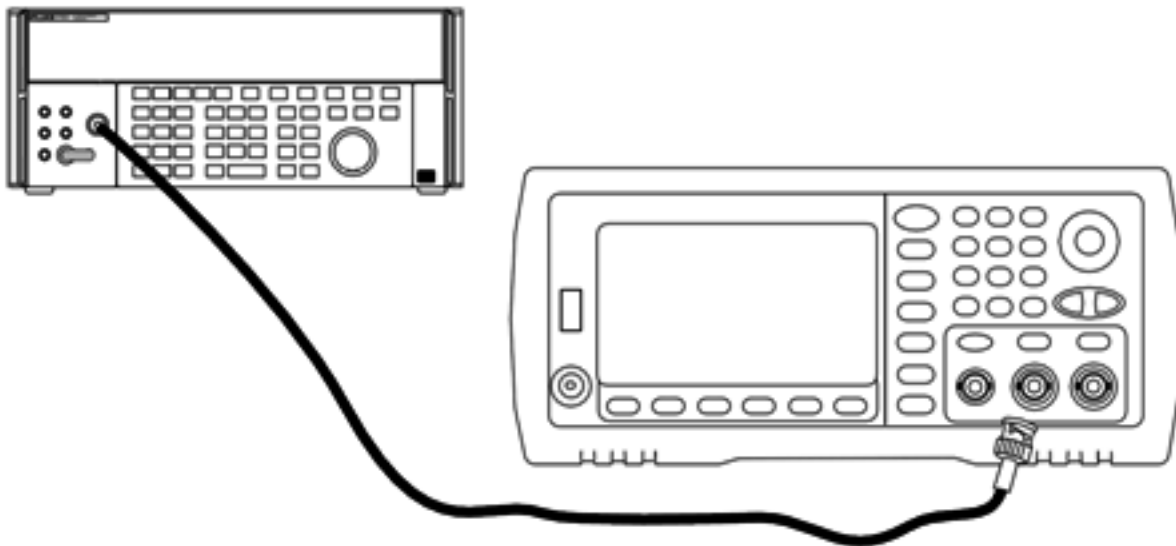

2. Use the precision AC voltmeter to measure the output amplitude for each setup in the table below.

Setup	Nominal Signal		
	Frequency	Amplitude	
38*	1 kHz	0.192 Vrms	Flatness for -24 dB range
39*	100 kHz		
40*	1 MHz		
41*	5 MHz		
42*	10 MHz		
43*	20 MHz		
44*	25 MHz		
45*	30 MHz		

\* Constants are stored after completing this setup.

3. Using the numeric keypad or knob, adjust the displayed voltage at each setup to match the measured voltage. Select **ENTER VALUE**.
4. To proceed:
- If your calibration procedures require you to verify the adjustment just made, exit the calibration menu and perform **-24 dB Range Flatness Verification**.
  - If you are making all of the adjustments and then verifying the instrument's performance, continue with the next procedure in this section.

[Previous Calibration Topic](#) [Next Calibration Topic](#)



### -8 dB Range Flatness Adjustment - 33500 Series

1. Connect a precision AC voltmeter to measure the output amplitude as shown below. Connect the BNC cable to the Wide Band input of the Fluke 5790A.

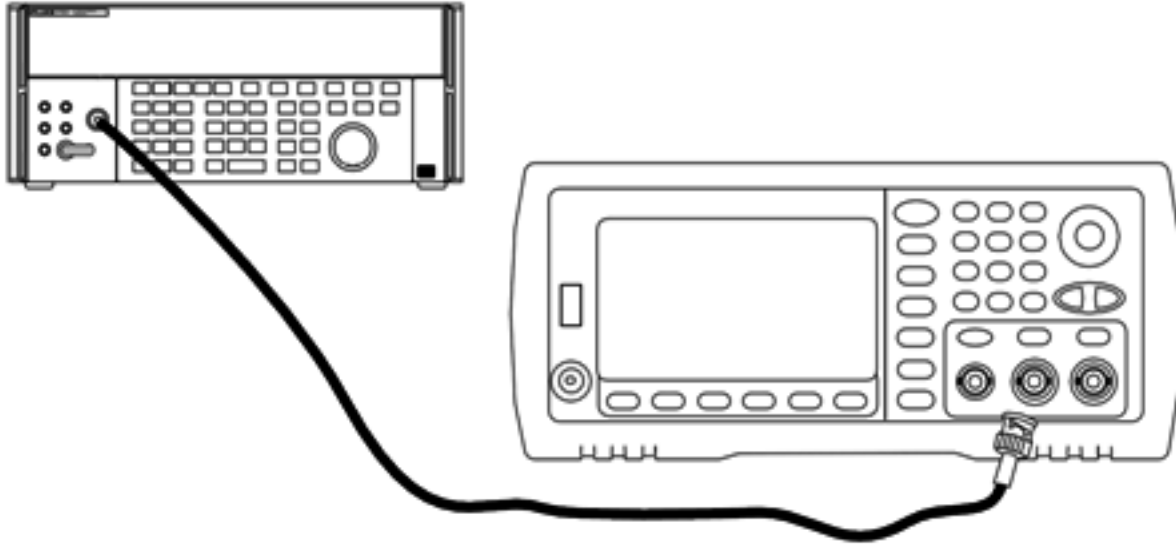

2. Use the precision AC voltmeter to measure the output amplitude for each setup in the table below.

Setup	Nominal Signal		
	Frequency	Amplitude	
46*	1 kHz	1.22 Vrms	Flatness for -8 dB range
47*	100 kHz		
48*	1 MHz		
49*	5 MHz		
50*	10 MHz		
51*	20 MHz		
52*	25 MHz		
53*	30 MHz		

\* Constants are stored after completing this setup.

3. Using the numeric keypad or knob, adjust the displayed voltage at each setup to match the measured voltage. Select **ENTER VALUE**.
4. To proceed:
  - a. If your calibration procedures require you to verify the adjustment just made, exit the calibration menu and perform **-8 dB Range Flatness Verification**.

- b. If you are making all the adjustments and then verifying the instrument's performance, verify the output specifications of the instrument with the [Performance Verification Tests](#).

This completes the adjustment procedures for the one-channel instrument. Verification of the output specifications is recommended.

If you are making adjustments to a two-channel instrument, continue with the next procedure in this section.

[Previous Calibration Topic](#)   [Next Calibration Topic](#)

## Channel 2 Adjustments - 33500 Series

The following topics describe calibration adjustments on channel 2.

- [Self Calibration Adjustment \(Channel 2\)](#)
- [Output Impedance Adjustment \(Channel 2\)](#)
- [AC Amplitude \(high-impedance\) Adjustment \(Channel 2\)](#)
- [-24 dB Range Flatness Adjustment \(Channel 2\)](#)
- [-8 dB Range Flatness Adjustment \(Channel 2\)](#)

[Previous Calibration Topic](#)   [Next Calibration Topic](#)

### Self Calibration Adjustment (Channel 2) - 33500 Series

1. Enter and begin the following setup.

Setup	
54*	Self-calibration. The output is disabled.

\* Constants are stored after completing this setup.

2. To proceed:
  - a. If your calibration procedures require you to verify the adjustment just made, exit the calibration menu and perform [DC Offset Voltage Verification](#). Be sure to do this for channel 2.
  - b. If you are making all of the adjustments and then verifying the instrument's performance, continue with the next procedure in this section.

#### NOTE

This setup requires approximately 15 seconds to complete.

[Previous Calibration Topic](#)   [Next Calibration Topic](#)

### Output Impedance Adjustment (Channel 2) - 33500 Series

The instrument stores calibration constants for the channels' output impedance. These constants are generated with and without the post-amplifier attenuator.

1. Set the DMM to measure offset-compensated, four-wire Ohms. Set the DMM to use 100 NPLC integration. Connect the Ohms Source and Ohms Sense DMM inputs to the channel output as shown below.

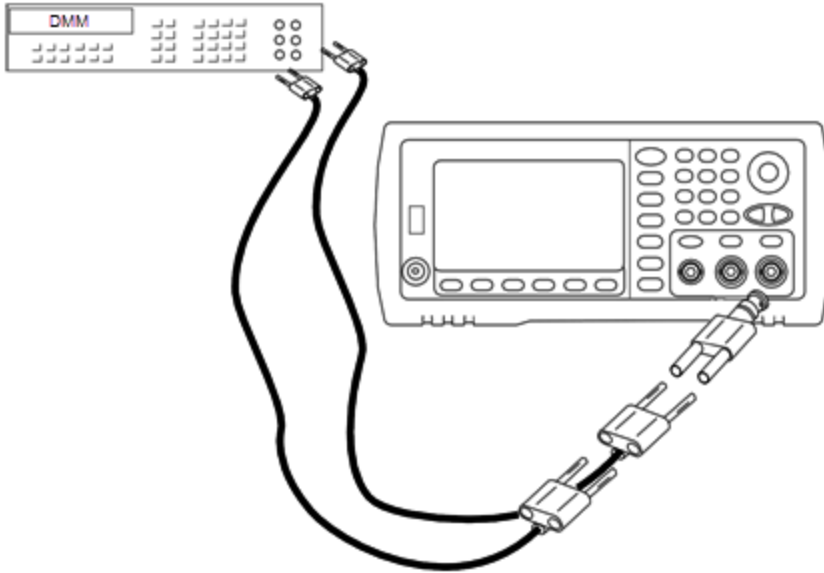

2. Use the DMM to make a 4-wire resistance measurement at the front panel output connector for each setup in the following table. The expected measured value is approximately 50  $\Omega$ .

Setup	
55*	-24 dB post-attenuator range
56*	0 dB

\* Constants are stored after completing this setup.

3. Using the numeric keypad or knob, adjust the displayed impedance at each setup to match the measured impedance. Select **ENTER VALUE**.
4. There are no specific operational verification tests for output impedance. Continue with the next adjustment procedure in this section.

[Previous Calibration Topic](#)   [Next Calibration Topic](#)

### AC Amplitude (high-impedance) Adjustment (Channel 2) - 33500 Series

The instrument stores a calibration constant for each high-impedance attenuator path. Each path's gain coefficient is calculated using two measurements: one with the waveform DAC at + output and one with waveform DAC at - output. The setups, therefore, must be performed in pairs.

1. Connect the DMM to the channel output as shown below.

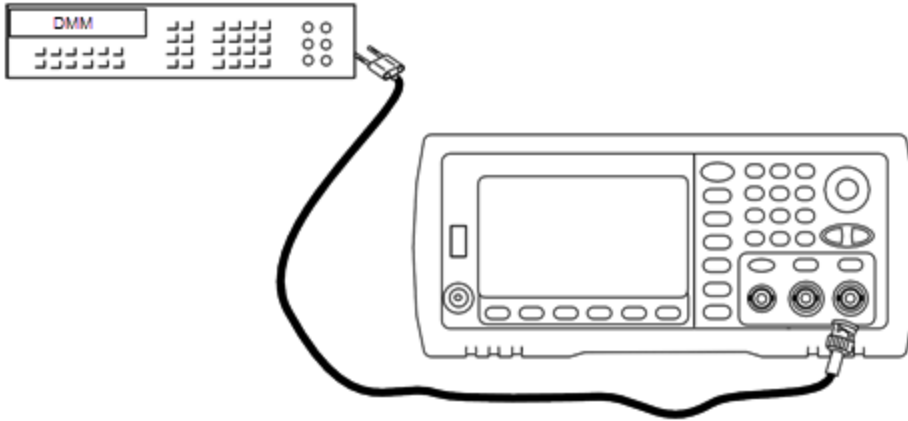

- Use the DMM to measure the DC voltage at the front panel connector for each setup in the following table.

	<b>Nominal Signal</b>	
<b>Setup</b>	<b>DC Level</b>	
57	+0.0028 V	Output of -72 dB range
58*	-0.0028 V	Output of -72 dB range
59	+0.007 V	Output of -64 dB range
60*	-0.007 V	Output of -64 dB range
61	+0.017 V	Output of -56 dB range
62*	-0.017 V	Output of -56 dB range
63	+0.044 V	Output of -48 dB range
64*	-0.044 V	Output of -48 dB range
65	+0.11 V	Output of -40 dB range
66*	-0.11 V	Output of -40 dB range
67	+0.28 V	Output of -32 dB range
68*	-0.28 V	Output of -32 dB range
69	+0.68 V	Output of -24 dB range
70*	-0.68 V	Output of -24 dB range
71	+1.7 V	Output of -16 dB range
72*	-1.7 V	Output of -16 dB range
73	+4.3 V	Output of -8 dB range
74*	-4.3 V	Output of -8 dB range
75	+10.8 V	Output of 0 dB range
76*	-10.8 V	Output of 0 dB range
77	+0.044 V	Output of -48 dB High DC range
78*	-0.044 V	Output of -48 dB High DC range
79	+0.11 V	Output of -40 dB High DC range
80*	-0.11 V	Output of -40 dB High DC range
81	+0.28 V	Output of -32 dB High DC range

	Nominal Signal	
Setup	DC Level	
82*	-0.28 V	Output of -32 dB High DC range
83	+0.68 V	Output of -24 dB High DC range
84*	-0.68 V	Output of -24 dB High DC range

\* Constants are stored after completing this setup.

3. Using the numeric keypad or knob, adjust the displayed voltage at each setup to match the measured voltage. Select **ENTER VALUE**.
4. To proceed:
  - a. If your calibration procedures require you to verify this adjustment, exit the calibration menu and perform **AC Amplitude (high-impedance) Verification**.
  - b. If you are making all of the adjustments and then verifying the instrument's performance, continue with the next procedure in this section.

[Previous Calibration Topic](#) [Next Calibration Topic](#)

#### -24 dB Range Flatness Adjustment (Channel 2) - 33500 Series

1. Connect a precision AC voltmeter to measure the output amplitude as shown below. Connect the BNC cable to the Wide Band input of the Fluke 5790A.

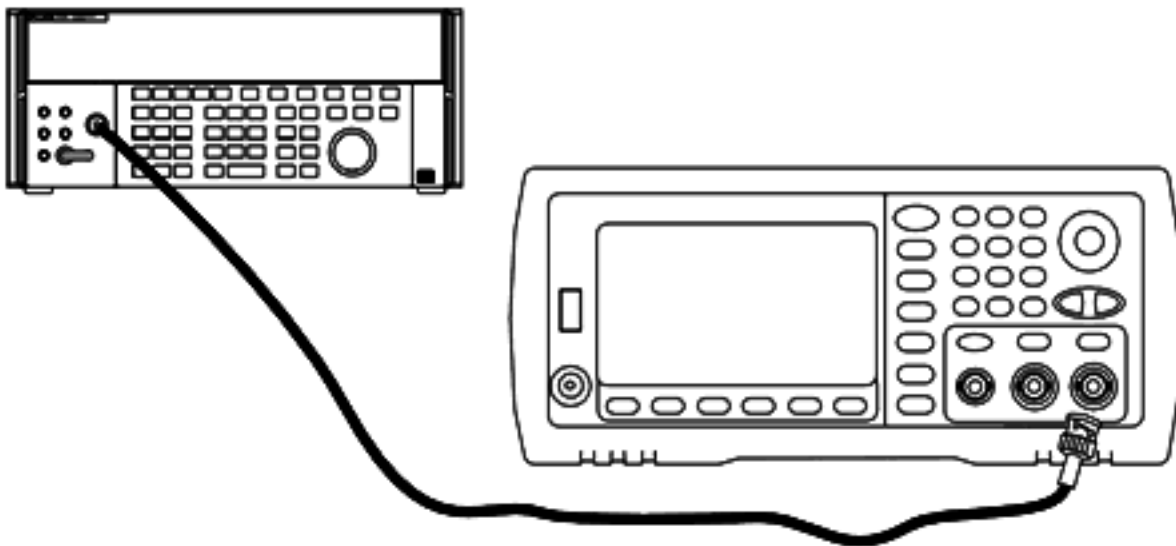

2. Use the precision AC voltmeter to measure the output amplitude for each setup in the table below.

Setup	Nominal Signal		
	Frequency	Amplitude	
85*	1 kHz	0.192 Vrms	Flatness for -24 dB range
86*	100 kHz		
87*	1 MHz		
88*	5 MHz		
89*	10 MHz		
90*	20 MHz		
91*	25 MHz		
92*	30 MHz		

\* Constants are stored after completing this setup.

3. Using the numeric keypad or knob, adjust the displayed voltage at each setup to match the measured voltage. Select **ENTER VALUE**.
4. To proceed:
  - a. If your calibration procedures require you to verify the adjustment just made, exit the calibration menu and perform **-24 dB Range Flatness Verification**. Be sure that you do this for Channel 2.
  - b. If you are making all of the adjustments and then verifying the instrument's performance, continue with the next procedure in this section.

[Previous Calibration Topic](#)   [Next Calibration Topic](#)

### **-8 dB Range Flatness Adjustment (Channel 2) - 33500 Series**

This section applies to channel 2. It checks high frequency AC amplitude flatness on the -8 dB attenuator range. It also checks flatness for all other ranges excluding the -24 dB and 0 dB attenuator ranges.

1. Connect a precision AC voltmeter to measure the output amplitude as shown below. Connect the BNC cable to the Wide Band input of the Fluke 5790A.

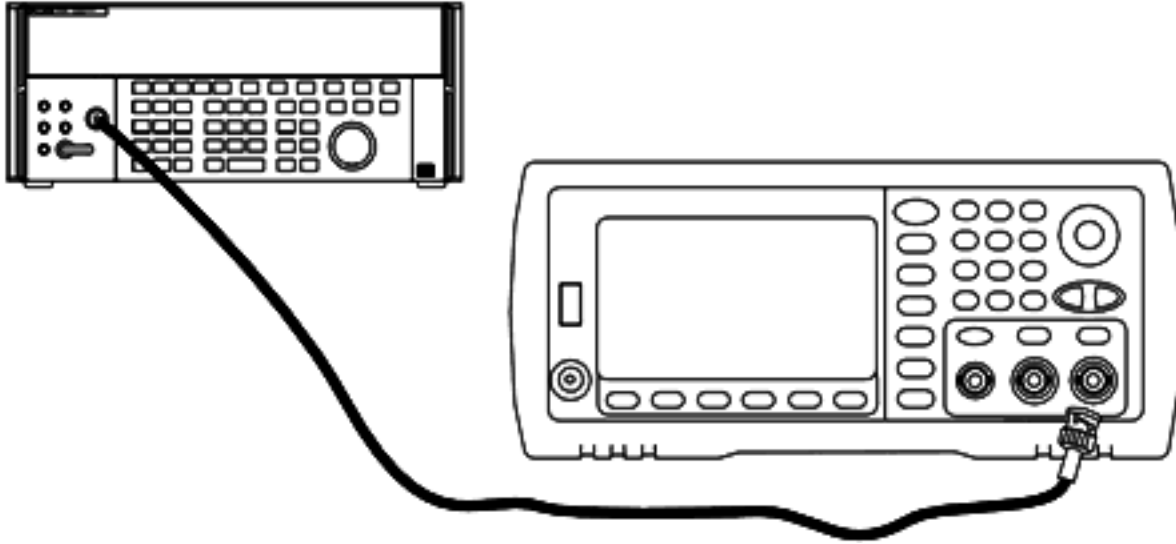

2. Use the precision AC voltmeter to measure the output amplitude for each setup in the table below.

Setup	Nominal Signal		
	Frequency	Amplitude	
93*	1 kHz	1.22 Vrms	Flatness for -8 dB range
94*	100 kHz		
95*	1 MHz		
96*	5 MHz		
97*	10 MHz		
98*	20 MHz		
99*	25 MHz		
100	30 MHz		

\* Constants are stored after completing this setup.

3. Using the numeric keypad or knob, adjust the displayed voltage at each setup to match the measured voltage. Select **ENTER VALUE**.
4. You have now completed the recommended adjustment procedures. Verification of the output specifications is recommended.
  - a. If your calibration procedures require you to verify the adjustment just made, exit the calibration menu and perform **-8 dB Range Flatness Verification**.

[Previous Calibration Topic](#)   [Next Calibration Topic](#)



## Calibration Errors - 33500 Series

The following errors may occur during calibration. There are also **system errors** and **self-test errors**. Some error messages include a failing channel number (1 or 2), shown as n in the messages below.

### **701 Calibration error; security defeated by hardware jumper**

If you short the calibration secure jumper (CAL ENABLE) while turning the instrument on, this error indicates the security password has been overwritten. See **Calibration Security** for details.

### **702 Calibration error; calibration memory is secured**

To perform calibration, unsecure the instrument. See **Calibration Security** for details.

### **703 Calibration error; secure code provided was invalid**

Specified security code was invalid.

### **706 Calibration error; value out of range**

Value entered was outside valid range.

### **707 Calibration error; signal input is out of range**

Occurs during the ADC Adjustment, setup 6, if the 1 V input voltage is too high. May also occur during self-calibration (setup 7). Run self-test to diagnose problem.

### **710 Self-calibration failed; Chan n, null DAC cal, invalid self cal**

**Self-calibration failed; Chan n, offset DAC cal with attenuator, invalid self cal**

**Self-calibration failed; Chan n, offset DAC cal no attenuator, invalid self cal**

Error occurred while performing internal calibration of specified DAC. Self-calibration exited without changing self-calibration constants. Run self-test to diagnose problem.

### **711 Self-calibration failed; Chan n, null DAC cal gain too low (too high), <meas\_value>**

**Self-calibration failed; Chan n, offset DAC cal with attenuator gain too low (too high), <meas\_value>**

**Self-calibration failed; Chan n, offset DAC cal no attenuator gain too low (too high), <meas\_value>**

Computed gain calibration factor for specified DAC was out of limits. Self-calibration exited without changing self-calibration constants. Run self-test to diagnose problem.

### **712 Self-calibration failed; Chan n, null DAC cal zero too low (too high), <meas\_value>**

**Self-calibration failed; Chan n, offset DAC cal with attenuator zero too low (too high), <meas\_value>**

**Self-calibration failed; Chan n, offset DAC cal no attenuator zero too low (too high), <meas\_value>**

**Self-calibration failed; Chan n, GND measurement out of limits, <meas\_value>**

Computed zero calibration factor for specified DAC was out of limits. Self-calibration exited without changing self-calibration constants. Run self-test to diagnose problem.

### **715 Self-calibration failed; Chan n, null DAC cal, convergence error sub attenuator value dB**

Internal null DAC calibration failed to converge during internal calibration. Self-calibration exited without changing self-calibration constants. Run self-test to diagnose problem.

**720 Self-calibration failed; Chan n, offset DAC cal with attenuator, convergence error**  
**Self-calibration failed; Chan n, offset DAC cal no attenuator, convergence error**

Internal offset DAC calibration failed to converge internal calibration. Self-calibration exited without changing self-calibration constants. Run self-test to diagnose problem.

**850 Calibration error; set up is invalid**

Invalid calibration setup number selected.

**850 Calibration error; set up is out of order**

Certain calibration steps require a specific beginning and ending. Do not enter into the middle of a calibration sequence.

[Previous Calibration Topic](#)

## Introduction to Calibration - 33600 Series

This chapter contains procedures for verifying the instrument's performance and adjustment (calibration).

The instrument uses closed-case electronic calibration; no internal mechanical adjustments are required. The instrument calculates correction factors based on input reference values that you set and stores correction factors in non-volatile memory until the next calibration adjustment is performed. This data is not changed by cycling power or \*RST.

## Keysight Technologies Calibration Services

Your local Keysight Technologies Service Center offers low-cost recalibration. The service center uses automated calibration systems that allow Keysight to provide calibration at competitive prices.

## Calibration Table of Contents

The section includes the following sections:

### Calibration Overview

- Calibration Interval
- Adjustment is Recommended
- Time Required for Calibration
- Automating Calibration Procedures
- Recommended Test Equipment
- Test Considerations
- Calibration Count
- Calibration Message

### Calibration Security

### Verification

#### Performance Verification Tests

- Self-Test
- Quick Performance Check
- Performance Verification Tests
- Amplitude and Flatness Verification Procedures

#### Internal Timebase Verification

#### AC Amplitude (high-impedance) Verification

#### DC Offset Voltage Verification

#### 1 Vpp Range Flatness Verification

4 Vpp Range Flatness Verification

8 Vpp Range Flatness Verification

General Calibration/Adjustment Procedure

Aborting a Calibration in Progress

Sequence of Adjustments

Self-Test

Frequency (Internal Timebase) Adjustment

Internal ADC Adjustment

Self Calibration Adjustment

Output Impedance Adjustment

AC Amplitude (high-impedance) Adjustment

1 Vpp Flatness Adjustment

4 Vpp Flatness Adjustment

8 Vpp Flatness Adjustment

Adjust Channel 2 (if necessary)

- Self Calibration Adjustment (Channel 2)
- Output Impedance Adjustment (Channel 2)
- AC Amplitude (high-impedance) Adjustment (Channel 2)
- 1 Vpp Flatness Adjustment (Channel 2)
- 4 Vpp Flatness Adjustment (Channel 2)
- 8 Vpp Flatness Adjustment

Calibration Errors

Next Calibration Topic

## Calibration Overview - 33600 Series

This section introduces the instrument's calibration features. For more detailed calibration information, see [Introduction to Calibration](#).

### Calibration Interval

The instrument should be calibrated on a regular interval determined by the accuracy requirements of your application. A one-year interval is adequate for most applications. Accuracy specifications are warranted only if adjustment is made at regular calibration intervals. Accuracy specifications are not

warranted beyond the one-year calibration interval. Keysight Technologies does not recommend calibration intervals beyond two years for any application.

### Adjustment is Recommended

Whatever calibration interval you select, Keysight Technologies recommends that complete re-adjustment should always be performed at the calibration interval. This ensures that the instrument will remain within specifications for the next calibration interval and provides the best long-term stability. Performance data measured using this method can be used to extend future calibration intervals. Use the Calibration Count to verify that all adjustments have been performed.

### Time Required for Calibration

For incoming instrument verification, do performance verification tests first. Then perform adjustments and re-run the performance verification tests. Each of these steps, if done manually, takes approximately 30 minutes per channel to perform.

The instrument can also be automatically calibrated under computer control. With computer control you can perform the complete calibration procedure and performance verification tests in approximately 30 minutes (one channel) or 60 minutes (two channels) once the instrument is warmed-up (see [Test Considerations](#)).

### Automating Calibration Procedures

You can use programmable test equipment to automate the complete verification and adjustment procedures. You can program each test's instrument configuration over the remote interface. Then enter read-back verification data into a test program and compare the results to the appropriate test limit.

You can also adjust the instrument from the remote interface, which is similar to the front panel procedure. Use a computer to perform the adjustment by first selecting the required function and range on the measurement equipment. Send the calibration value to the instrument and then initiate calibration over the remote interface.

You must [unsecure the instrument](#) before calibration.

A typical programming sequence for a single calibration setup is as follows:

1. **CAL:SETup 2** (configures instrument for calibration step 2)
2. Measure the output frequency with the external frequency counter
3. **CAL:VALue 9.99994321E6** (send the measured value to the instrument)
4. **CAL?** (initiates the calibration adjustment for setup 2)
5. Read **CAL?** query value to determine the failure (+1) or success (+0) of adjustment
6. **CAL:SETup 3** (configures instrument for calibration step 3)

For further information on instrument programming, see [Introduction to SCPI Language](#).

## Recommended Test Equipment

The test equipment recommended for the performance verification and adjustment procedures is listed below. If the exact instrument is not available, substitute calibration standards of equivalent accuracy.

Instrument	Requirements	Recommended Model	Use*
Digital Multimeter (DMM)	ACV, true rms, AC coupled accuracy: $\pm 0.02\%$ to 1 MHz DCV accuracy: 50 ppm resolution: 100 $\mu\text{V}$ Resistance Offset-compensated accuracy: $\pm 0.1 \Omega$	Keysight 3458A	Q, P, T
Precision AC Voltmeter	1000 Hz to 30 MHz, 0.1 Vrms to 2 Vrms ( $-7 \text{ dBm}$ to $+20 \text{ dBm}$ ) accuracy: 0.02 dB resolution: 0.01 dB	Fluke 5790A	Q, P, T
Frequency Counter	Accuracy: 0.1 ppm	Keysight 53230A Opt 010 (OCXO)	Q, P, T
Power Sensor	Specific model	Keysight N8482A	Q, P, T
Power Meter	Specific model (pick one of four)	Keysight N1911A, N1912A, N1913A, or N1914A	Q, P, T
Oscilloscope	1 GHz 4 Gs/second 50 $\Omega$ input termination	Keysight MSO6104A	T
Adapter	N type (m) to BNC (m)	Keysight E9623A	Q, P, T
Cable (2 required)	Dual banana (m) to dual banana (m)	Keysight 11000-60000	Q, P, T
Cable	RG58, BNC (m) to dual banana OR RG58 coaxial cable with BNC (m) to dual banana adapter		Q, P, T
Cable	RG58, BNC (m) to BNC (m)	Keysight 11170C	Q, P, T
Low-loss cable	Used for connecting to Type N attenuator, Fluke 5790A, and N8482A. Flatness verified by Precision Network Analyzer (PNA)	(Any as long as verified by PNA)	Q, P, T
10 to 20 dB Attenuator	Flatness verified by Precision Network Analyzer (PNA)	(Any as long as verified by PNA)	Q, P, T

\* Q = Quick Verification P = Performance Verification T = Troubleshooting

## Test Considerations

For optimal performance, all procedures should comply with the following recommendations:

## Service and Repair - Introduction

- Calibration ambient temperature is stable, between 18 and 28 °C. Ideally, it should be 23 ±1 °C.
- Ambient relative humidity is less than 80%.
- One-hour warm-up period before verification or adjustment.
- Measurement cables as short as possible, consistent with the impedance requirements.
- RG-58 or equivalent 50 Ω cable.

### Calibration Count

You can query the instrument to determine how many calibrations have been performed. The instrument was calibrated at the factory. When you receive your instrument, be sure to read the count to determine its initial value.

- This setting is non-volatile; it will not be changed by power cycling or \*RST.
- Because the value increments for each calibration point that stores a value, a complete calibration increases the value by many counts.

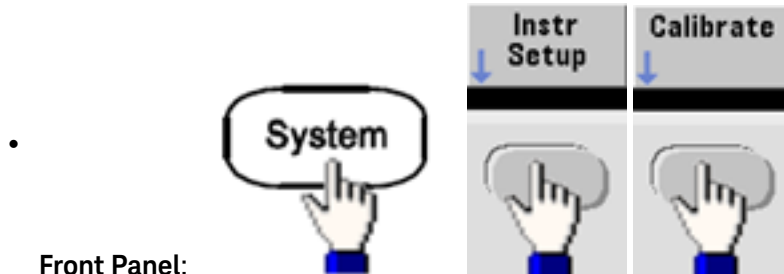

Front Panel:

- **SCPI:** CAL:COUNT?

### Calibration Message

You can store one message of up to 40 characters in calibration memory. For example, you can store the date when the last calibration was performed, the date when the next calibration is due, the instrument's serial number, or contact information for your calibration experts.

Unsecure the instrument to record a calibration message. You can read the message from either the front panel or over the remote interface, regardless of whether the instrument is secured.

- Storing a calibration message overwrites any message previously stored.
- This setting is non-volatile; it will not be changed by power cycling or \*RST.

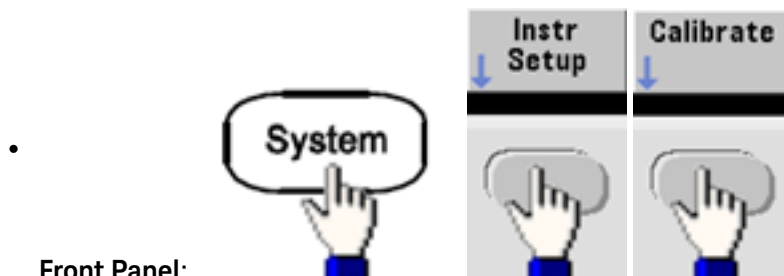

Front Panel:

- **SCPI:** CAL:STR "Cal Due: 01 August 2012"

[Previous Calibration Topic](#)   [Next Calibration Topic](#)

## Calibration Security - 33600 Series

This section describes the instrument's calibration security system.

### Security Overview

A security code prevents accidental or unauthorized instrument adjustments. The factory default security code for 33600 Series instruments is **AT33600**.

- Once you enter a security code, that code must be used for both front panel and remote operation. If you secure the instrument from the front panel, you must use that same code to unsecure it from the remote interface.
- This setting is non-volatile; it will not be changed by power cycling or **\*RST**.
- Security code rules:
  - Unquoted string up to 12 characters
  - Must start with letter (A-Z)
  - May contain letters, numbers (0-9) and underscores
- **Front Panel:**

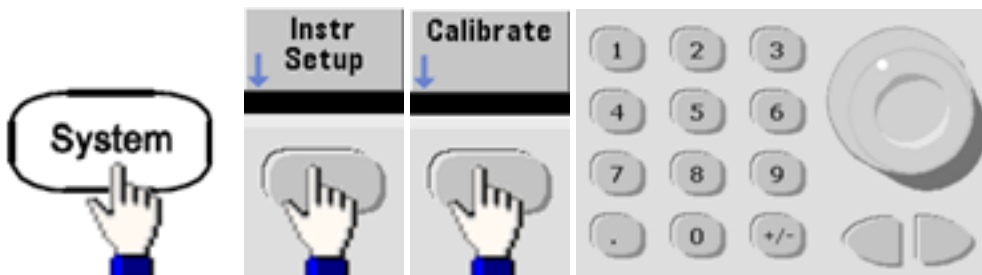

- **SCPI:** `CALibration_SECURITY:STATE`

### Unsecure Instrument Without Security Code

**CAUTION** See [Electrostatic Discharge \(ESD\) Precautions](#) before beginning this procedure.

1. Disconnect power cord and all input and output connections.
2. Disassemble the instrument (see [Disassembly - 33600 Series](#)).



## Service and Repair - Introduction

3. On the 33600 Series, apply a temporary short across pins A1 and B1 on the front panel PCBA, as shown below.

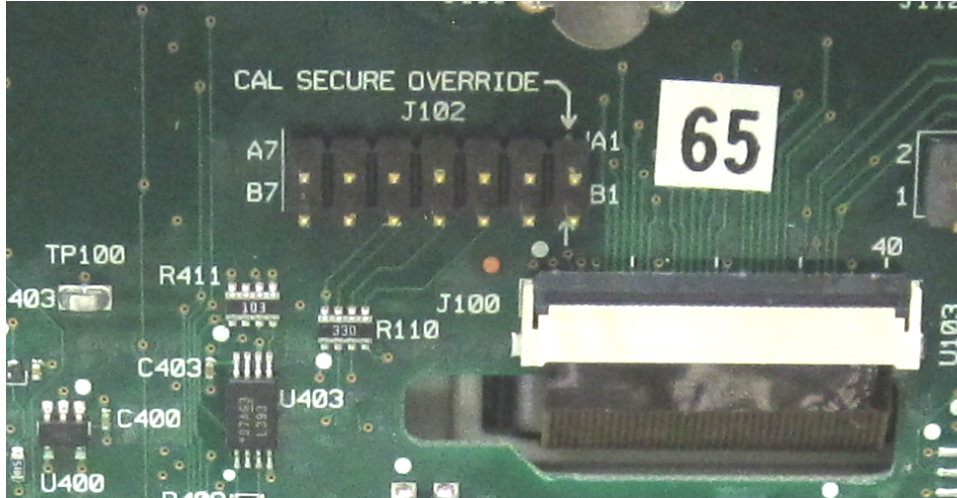

4. Attach power and turn on the instrument.

### **WARNING**

Be careful not to touch the power line connections or high voltages on the power supply module. Power is present even if the instrument is turned off.

5. The error queue will show the message "Calibration security has been disabled."

Calibration security is unlocked, with password reset to its factory default value. Calibration count is incremented because jumper was connected during power-up, and error message **+701,"Calibration error; security defeated by hardware jumper"** is issued. Nonvolatile calibration storage is updated to reflect these operations.

6. Turn off the instrument, remove temporary short, and remove power cord.
7. Reassemble the instrument.
8. Enter a new security code as described above, and record the security code in a safe location.

[Previous Calibration Topic](#)   [Next Calibration Topic](#)

## Verification - 33600 Series

The following topics describe the verification portion of the calibration procedure:

- [Performance Verification Tests](#)
- [Internal Timebase Verification](#)
- [AC Amplitude \(high-impedance\) Verification](#)
- [DC Offset Voltage Verification](#)
- [1 Vpp Range Flatness Verification](#)

- [4 Vpp Range Flatness Verification](#)
- [8 Vpp Range Flatness Verification](#)

[Previous Calibration Topic](#)   [Next Calibration Topic](#)

## Performance Verification Tests - 33600 Series

Use the Performance Verification Tests to verify the measurement performance of the instrument. The performance verification tests use the instrument's specifications listed on the product datasheet.

You can perform three levels of performance verification tests:

- **Self-Test** A series of internal verification tests that give high confidence that the instrument is operational.
- **Quick Verification** A combination of the internal self-tests and selected verification tests.
- **Performance Verification Tests** An extensive set of tests that are recommended as an acceptance test when you first receive the instrument or after performing adjustments.

### Self-Test

A brief power-on self-test occurs automatically whenever you turn on the instrument. This limited test assures that the instrument is operational. For details, see [Self-Test Procedures](#).

### Quick Performance Check

The quick performance check is a combination of internal self-test and an abbreviated performance test (specified by the letter Q in the performance verification tests). This test provides a simple method to achieve high confidence in the instrument's ability to functionally operate and meet specifications. These tests represent the absolute minimum set of performance checks recommended following any service activity. Auditing the instrument's performance for the quick check points (designated by a Q) verifies performance for normal accuracy drift mechanisms. This test does not check for abnormal component failures.

To perform the quick performance check, do the following:

1. Perform a [complete self-test](#).
2. Perform only the performance verification tests indicated with the letter Q.
3. If the instrument fails the quick performance check, adjustment or repair is required.

### Performance Verification Tests

The performance verification tests are recommended as acceptance tests when you first receive the instrument. The acceptance test results should be compared against the specifications on the product datasheet. After acceptance, you should repeat the performance verification tests at every calibration interval.

If the instrument fails performance verification, adjustment or repair is required.

Adjustment is recommended at every calibration interval. If adjustment is not made, you must guard band, using no more than 80% of the specifications listed in the datasheet, as the verification limits.

### Amplitude and Flatness Verification Procedures

The flatness verification procedures use a precision AC voltmeter and a power meter. You may substitute Thermal Voltage Converters (TVCs) to make measurements using appropriate operating procedures and test equipment.

The Fluke 5790A precision AC voltmeter is used to measure the amplitude from 1 kHz to 20 MHz. From 20 to 120 MHz, a power meter with the Keysight N8482A power sensor is used. Measurements of amplitudes from both the 5790A and the N8482A at 1 MHz to 20 MHz are used to scale the N8482A to the 5790A.

[Previous Calibration Topic](#)   [Next Calibration Topic](#)

### Internal Timebase Verification - 33600 Series

Verifies output frequency accuracy. All output frequencies are derived from a single generated frequency.

1. Connect a frequency counter to the channel 1 output as shown below (the frequency counter input should be terminated at 50 Ω).

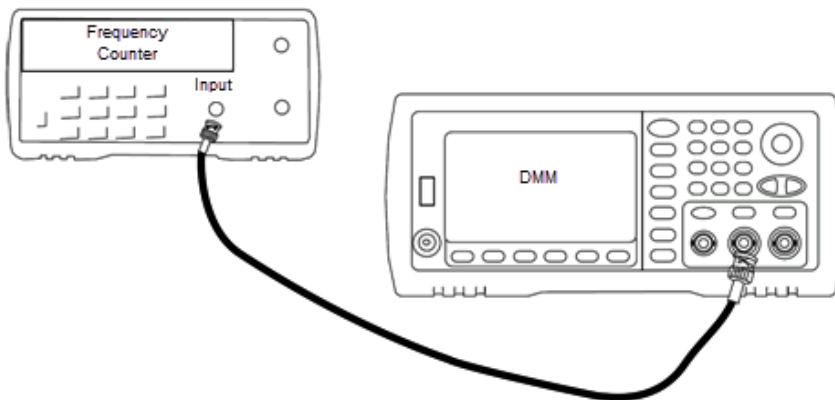

2. Set the instrument to the output described in the table below and measure the output frequency. *Be sure the instrument output is enabled.*

Use	Waveform Generator			Measurement	
	Function	Amplitude	Frequency	Nominal	Error*
Q	Sine	1.00 Vpp	10.0000000 MHz	10.000 MHz	±10 Hz

\* With the **optional high-stability OCXO timebase**, the measurement error is ±1 Hz.

3. Compare the measured value to the test limits shown in the table.

[Previous Calibration Topic](#)   [Next Calibration Topic](#)

## AC Amplitude (high-impedance) Verification - 33600 Series

Checks AC amplitude output accuracy at 1 kHz frequency using each attenuator.

1. Set the DMM to measure Vrms. Connect the DMM to the channel output as shown below.

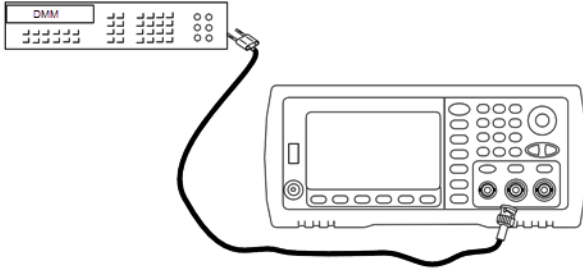

2. Set the instrument to each output in the table below and measure the output voltage with the DMM. Be sure the output impedance is set to High-Z and the output is enabled.

Use	Waveform Generator				Measurement	
	Output Setup	Function	Frequency	Amplitude	Nominal	Error*
Q	High Z**	Sine	1.000 kHz	400.0 mVrms	400.0 mVrms	±0.004707 Vrms
Q	High Z	Sine	1.000 kHz	400.0 mVrms	400.0 mVrms	±0.004707 Vrms
Q	High Z	Sine	1.000 kHz	1.00 Vrms	1.00 Vrms	±0.010707 Vrms
Q	High Z	Sine	1.000 kHz	2.500 Vrms	2.500 Vrms	±0.025707 Vrms
Q	High Z	Sine	1.000 kHz	7.000 Vrms	7.000 Vrms	±0.070707 Vrms

\* Based upon 1% of setting ±1 mVpp (50 Ω); converted to Vrms for High-Z.

\*\* Use the following sequence to set this output:

- a. Set amplitude to 400.0 mVrms
  - b. Set DC Offset to 1.0 VDC
  - c. Set Auto-Range to OFF
  - d. Set DC Offset Voltage to 0.0 VDC
  - e. After the measurement, set autorange ON for remaining measurements.
3. Compare the measured value to the test limits shown in the table.
  4. Two-channel instruments only: connect DMM to channel 2 output and repeat steps 2 and 3.

[Previous Calibration Topic](#)   [Next Calibration Topic](#)

## DC Offset Voltage Verification - 33600 Series

Checks the DC Offset Voltage on two attenuator ranges:

## Service and Repair - Introduction

1. Set the DMM to measure DCV. Connect the DMM to the channel output as shown below.

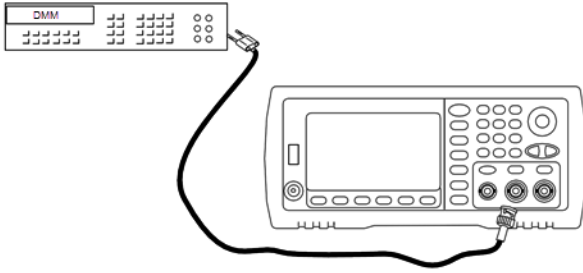

2. Set the instrument to each output in the table below and measure the output voltage with the DMM.

Use	Waveform Generator			Measurement	
	Output Setup	Function	Voltage	Nominal	Error*
Q	High Z	DC	0.0 V	0.0 VDC	±0.002 VDC
Q	High Z	DC	500 mV	0.500 VDC	±0.007 VDC
Q	High Z	DC	10.0 V	10.0 VDC	±0.102 VDC

\* Based upon 1% of setting ±2 mVDC for High-Z.

3. Compare the measured value to the test limits shown in the table.
4. Two-channel instruments only: connect DMM to channel 2 output and repeat steps 2 and 3.

[Previous Calibration Topic](#)   [Next Calibration Topic](#)

### 1 Vpp Range Flatness Verification - 33600 Series

Checks high frequency AC amplitude flatness on the 1 Vpp range.

1. Connect a precision AC voltmeter to measure the output amplitude as shown below. Connect the BNC cable to the Wide Band input of the Fluke 5790A. If you are using substitute test equipment, verify that the input impedance is 50 Ω, because load accuracy directly affects measurement quality.

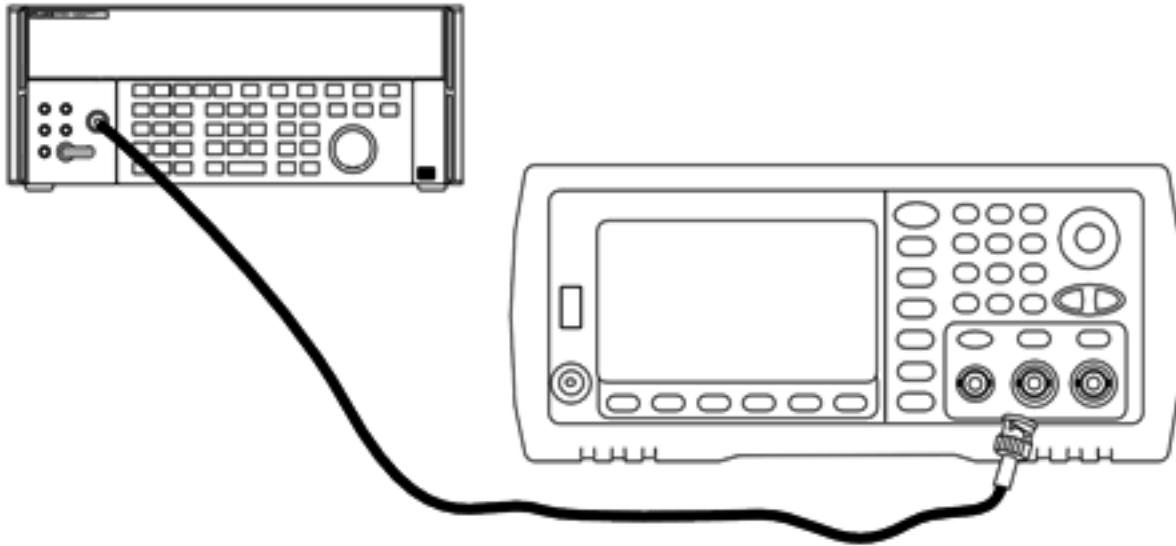

2. Set the precision AC Voltmeter to "Medium, Medium" Digital Filter and Filter Restart.
3. Set the output impedance to 50 Ω. Be sure the output is enabled. Configure the instrument as described in the table below and measure the output amplitude with the AC voltmeter. This will become the reference measurement. Record this  $V_{rms}$  value in the table below and also record its dBm equivalent by using the formula  $dBm = 10 \times \log_{10}(20 \times V_{rms}^2)$ .

Use	Waveform Generator				Measurement
	Output Load	Function	Amplitude	Frequency	Measured Result
Q	50 Ω	Sine	0.354 Vrms (3.990 dBm)	1.000 kHz	Vrms dBm

4. Set the waveform generator function, amplitude, and frequency as described in the table below. Measure the amplitude and record the results in the table below.

Use	Waveform Generator				Measurement	
	Output Load	Function	Amplitude	Frequency	Error Relative to Step 3 Reference (Vrms)	Measured Result (Vrms)
	50 Ω	Sine	0.354 Vrms	100.000 kHz	±1.15%	
				500.000 kHz		
				1.000 MHz*		
				5.000 MHz*		
	50 Ω	Sine	0.354 Vrms	10.00 MHz*	±2.92%	
				20.00 MHz*		

\* These values are used in the Correction Factor Table below.

5. In order to scale the power meter to the Fluke 5790A, a correction factor is calculated using the table below. The measurements of amplitudes from both the 5790A and the power meter at 1 MHz to 20 MHz are used. Enter the measured values for 1, 5, 10, and 20 MHz made with the Fluke 5790A into the Correction Factor table below. Then use the following formula to convert the Vrms results to dBm:

$$\text{dBm} = 10 \times \log_{10}(20 \times \text{Vrms}^2)$$

Compute the average (arithmetic mean) of the four dBm results and enter the result into the table at the bottom of the Fluke 5790A dBm column.

- Connect the N8482A to the channel 1 output of the waveform generator using a Type N connector as shown below. Repeat the 1, 5, 10, and 20 MHz measurements and enter the dBm results into the table below. Compute the average (arithmetic mean) of the four dBm results and enter the result into the table at the bottom of the Power Meter dBm column.

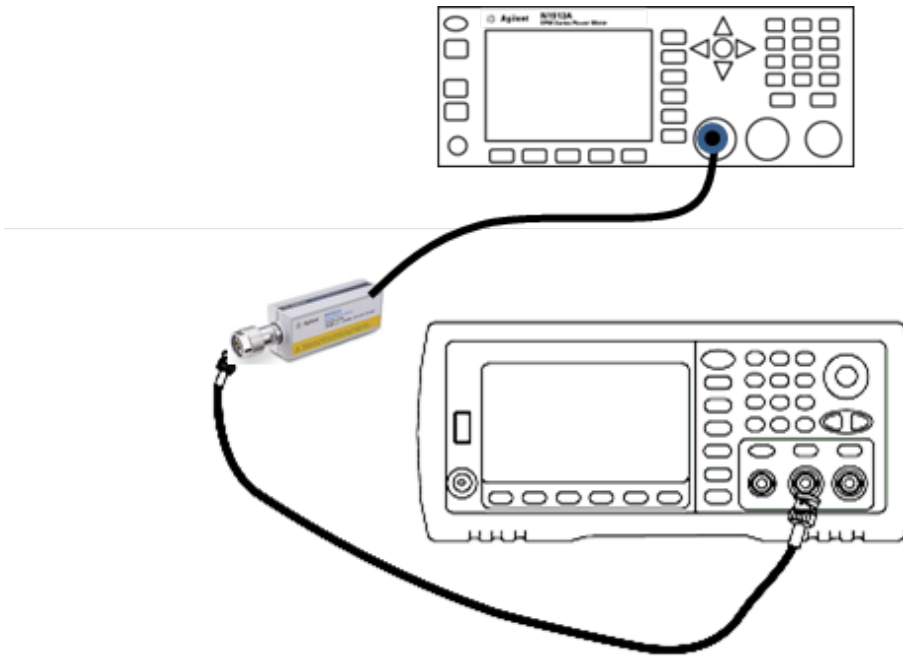

- Subtract the Power Meter dBm average from the Fluke 5790A dBm average to compute the correction factor. Record the result in the lower right corner of the Correction Factor table. Add this correction factor to all of your Power Meter measurements.

**Correction Factor Table**

Frequency	Fluke 5790A		Power Meter	
	Vrms (measured)	dBm (see formula)		dBm (measured)
1 MHz				
5 MHz				
10 MHz				
20 MHz				
	<b>Average (mean):</b>		<b>Average (mean):</b>	
<b>Correction Factor (Fluke 5790A Average minus Power Meter average):</b>				



- Make the following measurements using the power meter. Set the 33600 Series instrument to the function, amplitude, and frequencies shown below. Record the measured dBm (remembering to add the correction factor) for each frequency in the table below.

Use	Waveform Generator				Measurement		
	Output Load	Function	Amplitude	Frequency	Error Relative to Step 3 Reference	Measured Result (dBm)	Corrected Result (dBm)
	50 $\Omega$	Sine	0.354 Vrms	30.00 MHz	$\pm 0.20$ dB		
				40.00 MHz			
				50.00 MHz			
				60.00 MHz			
	50 $\Omega$	Sine	0.354 Vrms	70.00 MHz	$\pm 0.30$ dB		
				80.00 MHz			
	50 $\Omega$	Sine	0.354 Vrms	90.00 MHz	$\pm 0.40$ dB		
				100.00 MHz			
				110.00 MHz			
				120.00 MHz			

- Compare the measured values to the test limits shown in both tables.
- Two-channel instruments only: Connect the AC voltmeter to channel 2 and repeat steps 2 through 6.

[Previous Calibration Topic](#)   [Next Calibration Topic](#)

#### 4 Vpp Range Flatness Verification - 33600 Series

Checks high frequency AC amplitude flatness on the 4 Vpp range.

1. Connect a precision AC voltmeter to measure the output amplitude as shown below. Connect the BNC cable to the Wide Band input of the Fluke 5790A. If you are using substitute test equipment, verify that the input impedance is 50 Ω, because load accuracy directly affects measurement quality.

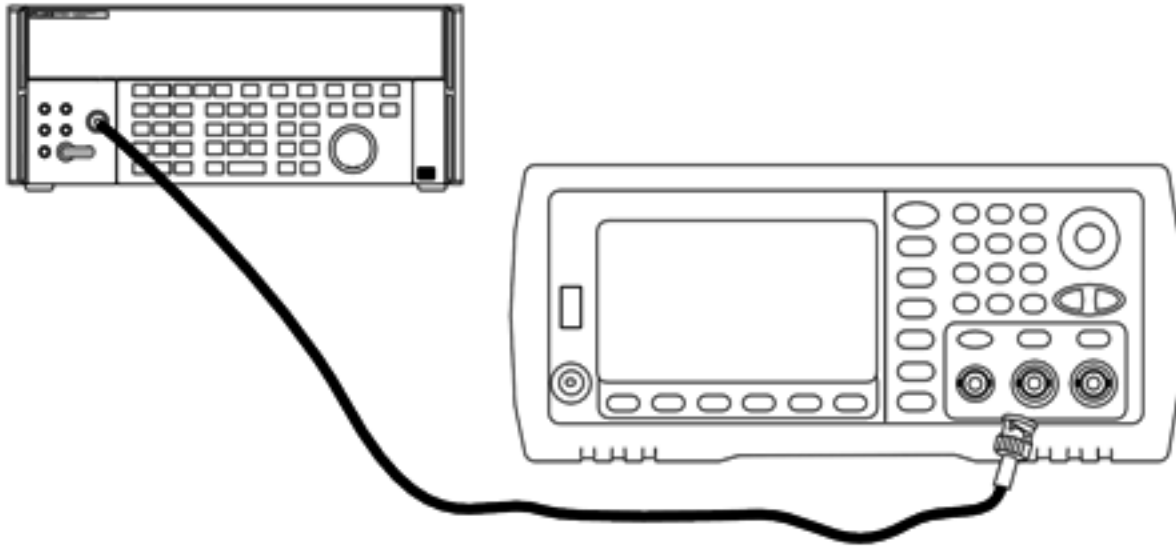

2. Set the precision AC Voltmeter to "Medium, Medium" Digital Filter and Filter Restart.
3. Set the output impedance to 50 Ω. Be sure the output is enabled. Configure the instrument as described in the table below and measure the output amplitude with the AC voltmeter. This will become the reference measurement. Record this  $V_{rms}$  value in the table below and also record its dBm equivalent by using the formula  $dBm = 10 \times \log_{10}(20 \times V_{rms}^2)$ .

Use	Waveform Generator			Frequency	Measurement
	Output Load	Function	Amplitude		Measured Result
Q	50 Ω	Sine	1.414 $V_{rms}$ (16.019 dBm)	1.000 kHz	$V_{rms}$ dBm

4. Set the waveform generator function, amplitude, and frequency as described in the table below. Measure the amplitude and record the results in the table below.

Use	Waveform Generator				Measurement	
	Output Load	Function	Amplitude	Frequency	Error Relative to Step 3 Reference (Vrms)	Measured Result (Vrms)
	50 Ω	Sine	1.414 Vrms	100.000 kHz	±1.15%	
				500.000 kHz		
				1.000 MHz*		
				5.000 MHz*		
	50 Ω	Sine	1.414 Vrms	10.00 MHz*	±2.92%	
				20.00 MHz*		

\* These values are used in the Correction Factor Table below.

5. In order to scale the power meter to the Fluke 5790A, a correction factor is calculated using the table below. The measurements of amplitudes from both the 5790A and the power meter at 1 MHz to 20 MHz are used. Enter the measured values for 1, 5, 10, and 20 MHz made with the Fluke 5790A into the Correction Factor table below. Then use the following formula to convert the Vrms results to dBm:

$$\text{dBm} = 10 \times \log_{10}(20 \times \text{Vrms}^2)$$

Compute the average (arithmetic mean) of the four dBm results and enter the result into the table at the bottom of the Fluke 5790A dBm column.

- Connect the N8482A to the channel 1 output of the waveform generator using a Type N connector as shown below. Repeat the 1, 5, 10, and 20 MHz measurements and enter the dBm results into the table below. Compute the average (arithmetic mean) of the four dBm results and enter the result into the table at the bottom of the Power Meter dBm column.

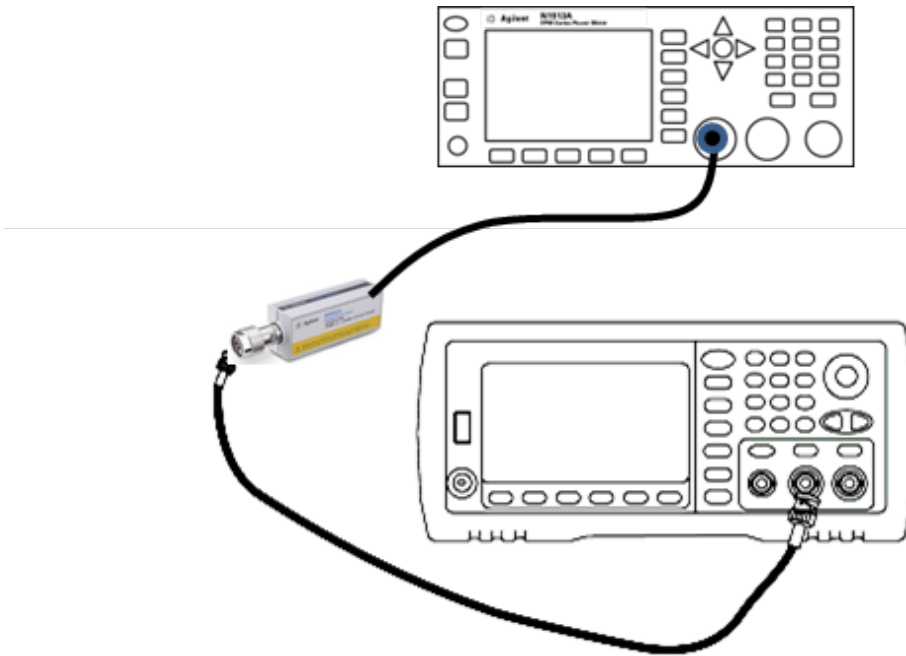

- Subtract the Power Meter dBm average from the Fluke 5790A dBm average to compute the correction factor. Record the result in the lower right corner of the Correction Factor table. Add this correction factor to all of your Power Meter measurements.

**Correction Factor Table**

Frequency	Fluke 5790A		Power Meter	
	Vrms (measured)	dBm (see formula)		dBm (measured)
1 MHz				
5 MHz				
10 MHz				
20 MHz				
	<b>Average (mean):</b>		<b>Average (mean):</b>	
<b>Correction Factor (Fluke 5790A Average minus Power Meter average):</b>				

- Make the following measurements using the power meter. Set the 33600 Series instrument to the function, amplitude, and frequencies shown below. Record the measured dBm (remembering to add the correction factor) for each frequency in the table below.

Use	Waveform Generator				Measurement		
	Output Load	Function	Amplitude	Frequency	Error Relative to Step 3 Reference	Measured Result (dBm)	Corrected Result (dBm)
	50 $\Omega$	Sine	1.414 Vrms	30.00 MHz	$\pm 0.25$ dB		
				40.00 MHz			
				50.00 MHz			
				60.00 MHz			
	50 $\Omega$	Sine	1.414 Vrms	70.00 MHz	$\pm 0.40$ dB		
				80.00 MHz			
	50 $\Omega$	Sine	1.414 Vrms	90.00 MHz	$\pm 0.50$ dB		
				100.00 MHz			
				110.00 MHz			
				120.00 MHz			

- Compare the measured values to the test limits shown in both tables.
- Two-channel instruments only: Connect the AC voltmeter to channel 2 and repeat steps 2 through 6.

[Previous Calibration Topic](#)   [Next Calibration Topic](#)

### 8 Vpp Range Flatness Verification - 33600 Series

Checks high frequency AC amplitude flatness on the 8 Vpp range.

1. Connect a precision AC voltmeter to measure the output amplitude as shown below. Connect the BNC cable to the Wide Band input of the Fluke 5790A. If you are using substitute test equipment, verify that the input impedance is 50 Ω, because load accuracy directly affects measurement quality.

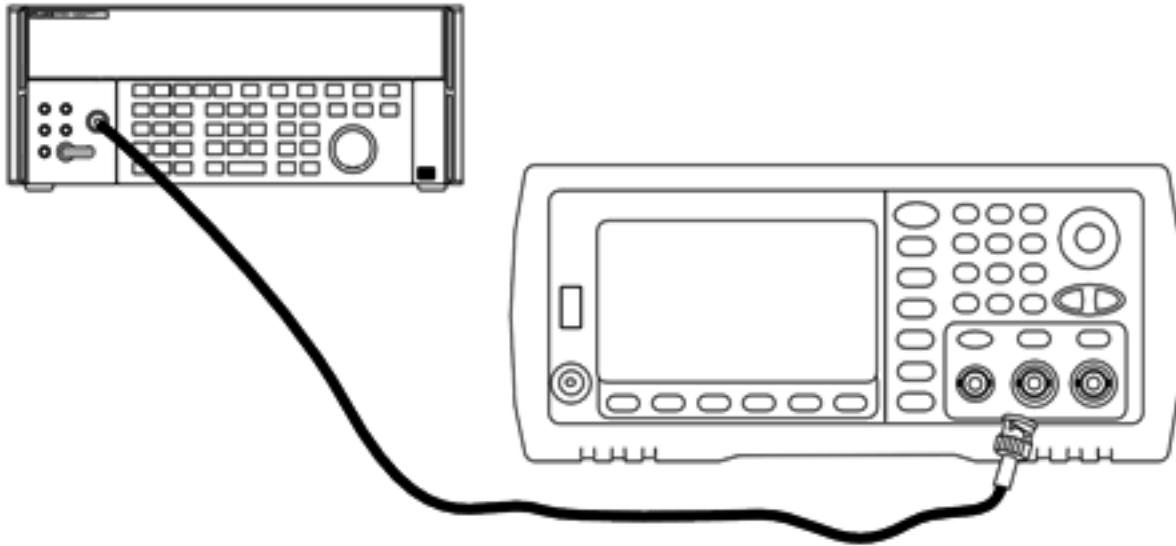

2. Set the precision AC Voltmeter to "Medium, Medium" Digital Filter and Filter Restart.
3. Set the output impedance to 50 Ω. Be sure the output is enabled. Configure the instrument as described in the table below and measure the output amplitude with the AC voltmeter. This will become the reference measurement. Record this  $V_{rms}$  value in the table below and also record its dBm equivalent by using the formula  $dBm = 10 \times \log_{10}(20 \times V_{rms}^2)$ .

Use	Waveform Generator			Measurement	
	Output Load	Function	Amplitude	Frequency	Measured Result
Q	50 Ω	Sine	2.828 $V_{rms}$ (22.040 dBm)	1.000 kHz	$V_{rms}$ dBm

4. Set the waveform generator function, amplitude, and frequency as described in the table below. Measure the amplitude and record the results in the table below.

Use	Waveform Generator				Measurement	
	Output Load	Function	Amplitude	Frequency	Error Relative to Step 3 Reference (Vrms)	Measured Result (Vrms)
	50 Ω	Sine	2.828 Vrms	100.000 kHz	±1.15%	
				500.000 kHz		
				1.000 MHz*		
				5.000 MHz*		
	50 Ω	Sine	2.828 Vrms	10.00 MHz*	±2.92%	
				20.00 MHz*		

\* These values are used in the Correction Factor Table below.

5. In order to scale the power meter to the Fluke 5790A, a correction factor is calculated using the table below. The measurements of amplitudes from both the 5790A and the power meter at 1 MHz to 20 MHz are used. Enter the measured values for 1, 5, 10, and 20 MHz made with the Fluke 5790A into the Correction Factor table below. Then use the following formula to convert the Vrms results to dBm:

$$\text{dBm} = 10 \times \log_{10}(20 \times \text{Vrms}^2)$$

Compute the average (arithmetic mean) of the four dBm results and enter the result into the table at the bottom of the Fluke 5790A dBm column.

6. Connect the N8482A to the channel 1 output of the waveform generator using a Type N connector as shown below. Repeat the 1, 5, 10, and 20 MHz measurements and enter the dBm results into the table below. Compute the average (arithmetic mean) of the four dBm results and enter the result into the table at the bottom of the Power Meter dBm column.

**CAUTION**

To avoid damaging the N8482A power sensor, be sure to insert the 10 to 20 dB attenuator in series with the measurement.

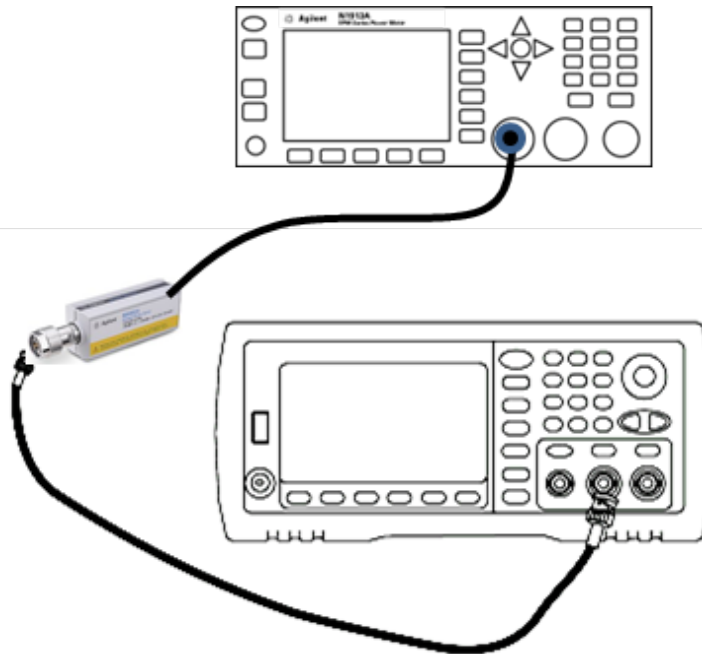



- Subtract the Power Meter dBm average from the Fluke 5790A dBm average to compute the correction factor. Record the result in the lower right corner of the Correction Factor table. Add this correction factor to all of your Power Meter measurements.

**Correction Factor Table**

	Fluke 5790A		Power Meter	
Frequency	Vrms (measured)	dBm (see formula)		dBm (measured)
1 MHz				
5 MHz				
10 MHz				
20 MHz				
	<b>Average (mean):</b>		<b>Average (mean):</b>	
<b>Correction Factor (Fluke 5790A Average minus Power Meter average):</b>				

- Make the following measurements using the power meter. Set the 33600 Series instrument to the function, amplitude, and frequencies shown below. Record the measured dBm (remembering to add the correction factor) for each frequency in the table below.

	Waveform Generator				Measurement		
Use	Output Load	Function	Amplitude	Frequency	Error Relative to Step 3 Reference	Measured Result (dBm)	Corrected Result (dBm)
	50 Ω	Sine	2.828 Vrms	30.00 MHz	±0.25 dB		
				40.00 MHz			
				50.00 MHz			
				60.00 MHz			
	50 Ω	Sine	2.828 Vrms	70.00 MHz	±0.40 dB		
				80.00 MHz			

- Compare the measured values to the test limits shown in both tables.
- Two-channel instruments only: Connect the AC voltmeter to channel 2 and repeat steps 2 through 6.

[Previous Calibration Topic](#)   [Next Calibration Topic](#)

## General Calibration/Adjustment Procedure - 33600 Series

Recommended method for a complete instrument calibration:

1. Read **Test Considerations**.
2. **Perform the verification tests** to characterize the instrument (incoming data).
3. Press [**System** > **Instr Setup** > **Calibrate**. If the instrument is secured from calibration, **unsecure it**.
4. Enter the Setup Number for the procedure being performed. The default setup number is "1" and, from the front panel, the number will increment as the procedures are performed.
5. Select **BEGIN**.
6. For setups that require an input, adjust the value shown in the display to the measured value and select **ENTER VALUE**.
7. The setup automatically advances to the next required value.

To cancel the adjustment procedure, select **CANCEL STEP**. The display will return to the setup number entry.

8. When finished, select **END CAL**.
9. (Optional) Set a new calibration message using the remote interface. The message (up to 40 characters) is stored with the calibration coefficients.
10. Secure the instrument against calibration.
11. Note the new security code and calibration count in the instrument's maintenance records.

[Previous Calibration Topic](#)   [Next Calibration Topic](#)

## Aborting a Calibration in Progress - 33600 Series

Sometimes it may be necessary to abort a calibration in progress. You can abort a calibration at any time by turning off the power or by issuing a remote interface device clear message followed by **\*RST**.

The instrument stores calibration constants at the end of each adjustment procedure. If you lose power, or otherwise abort an adjustment in progress, you will only need to perform the interrupted adjustment procedure again.

### CAUTION

If power is lost when the instrument is attempting to write new calibration constants to memory, you may lose all calibration constants for the function. Typically, upon re-applying power, the instrument will report error **"-313, Calibration Memory Lost"**.

[Previous Calibration Topic](#)   [Next Calibration Topic](#)

## Sequence of Adjustments - 33600 Series

The adjustment sequence in the numbered steps minimizes the number of test equipment setups and connection changes.

You may perform individual adjustments as necessary, but setups 1 through 7 must be performed in order, before any other setup procedure.

[Previous Calibration Topic](#)   [Next Calibration Topic](#)

## Self-Test - 33600 Series

Run self-test to ensure that the instrument is in working order before beginning any additional adjustments.

Be sure to unlock the instrument and follow the requirements listed in [Test Considerations](#) before beginning any adjustments.

1. Press [**System** > **Instr Setup** > **Calibrate**. Enter setup number 1 and select **BEGIN**.

Setup	
1	Performs the self-test. The Main Output is disabled during test.

2. If the instrument fails any self-test, you must repair the instrument before continuing the adjustment procedures.

A complete self-test (\*TST?) takes approximately 15 seconds.

[Previous Calibration Topic](#)   [Next Calibration Topic](#)

## Frequency (Internal Timebase) Adjustment - 33600 Series

The instrument stores a calibration constant that sets the crystal oscillator to put out exactly 10 MHz. The instrument should have been running continuously for 30 minutes prior to this calibration adjustment to ensure timebase stability

1. Set the frequency counter resolution to better than 0.01 ppm and the input termination to 50 Ω (if your frequency counter does not have a 50 Ω input termination, you must provide an external termination). Make the connections shown below.

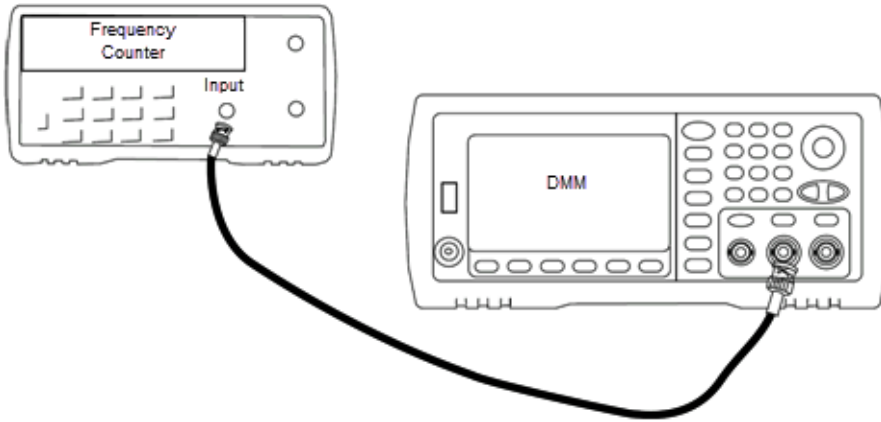

2. Use the frequency counter to measure the output frequency for each setup in the following table.

	Nominal Signal		
Setup	Frequency	Amplitude	
2	<10 MHz	~1 Vpp	Output frequency is slightly less than 10 MHz
3	>10 MHz		Output frequency is slightly more than 10 MHz
4	~10 MHz		Output frequency should be near 10 MHz
5*	10 MHz		Output frequency should be 10 MHz ± 1 ppm

\* Constants are stored after completing this setup.

3. Using the numerical keypad or knob, adjust the displayed frequency at each setup to match the measured frequency. Select **ENTER VALUE**.
4. To proceed:
  - a. If your calibration procedures require you to verify the adjustment just made, exit the calibration menu and perform **Internal Timebase Verification**.
  - b. If you are making all of the adjustments and then verifying the instrument's performance, continue with the next procedure in this section.

[Previous Calibration Topic](#)   [Next Calibration Topic](#)

### Internal ADC Adjustment - 33600 Series

The instrument stores calibration constants related to the gain and offset of the internal ADC. Setup 8 must always be performed before any other amplitude adjustments are attempted. The internal ADC is then used as a source for the calibration constants generated in self calibration (Setup9). (Setup 6 and Setup 7 are not used.)

1. Connect the channel 1 output to the instrument's rear panel Modulation Input and DMM as shown below.

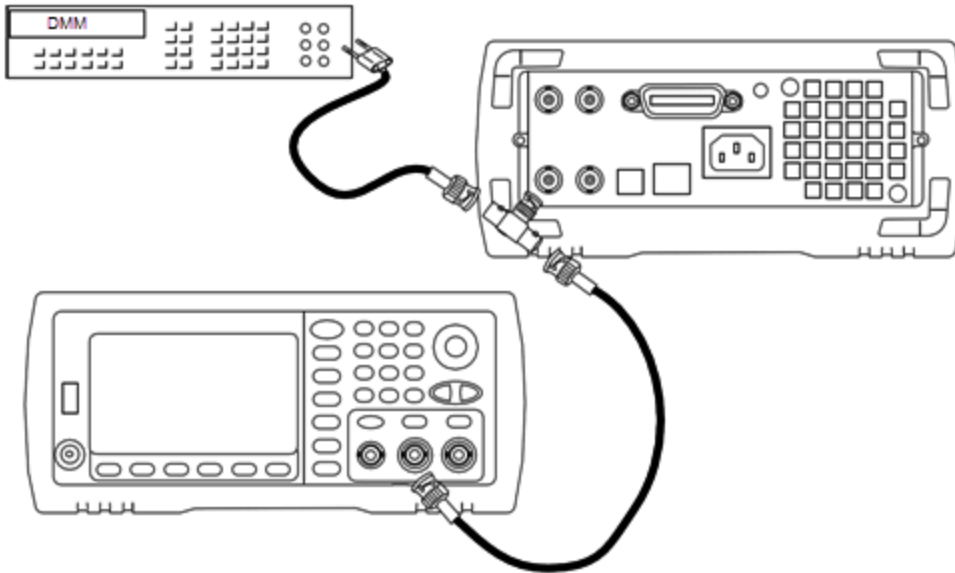

2. Set the DMM to display 5½ digits and set the function to DCV.
3. Enter the following setup.

	Nominal Signal	
Setup	DC level	
8*	~1.1 VDC ±10%	Calibrates the internal ADC.

\* Constants are stored after completing this setup.

4. Use the numeric keypad or knob to enter the value measured on the DMM.

**NOTE**

This setup requires approximately 15 seconds to complete.

5. Disconnect all cables from the instrument.

[Previous Calibration Topic](#)   [Next Calibration Topic](#)

### Self Calibration Adjustment - 33600 Series

1. Enter and begin the following setup.

Setup	
9*	Self-calibration. The output is disabled.

\* Constants are stored after completing this setup.

2. To proceed:

- a. If your calibration procedures require you to verify the adjustment just made, exit the calibration menu and perform **DC Offset Voltage Verification**.
- b. If you are making all of the adjustments and then verifying the instrument's performance, continue with the next procedure in this section.

**NOTE** This setup requires approximately 15 seconds to complete.

[Previous Calibration Topic](#)   [Next Calibration Topic](#)

### Output Impedance Adjustment - 33600 Series

The instrument stores calibration constants for the channels' output impedance. These constants are generated with and without the post-amplifier attenuator.

1. Set the DMM to measure offset-compensated, four-wire Ohms. Set the DMM to use 100 NPLC integration. Connect the Ohms Source and Ohms Sense DMM inputs to the channel output as shown below.

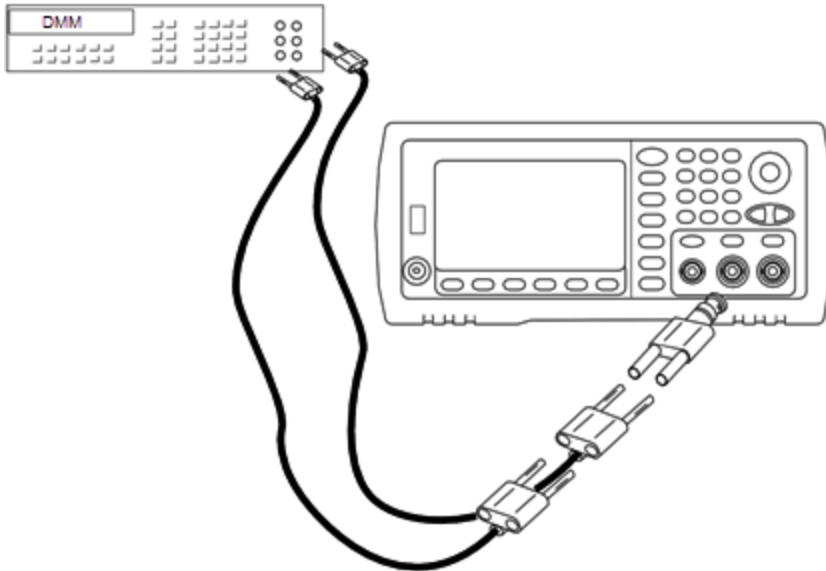

2. Use the DMM to make a 4-wire resistance measurement at the front panel output connector for each setup in the following table. The expected measured value is approximately 50 Ω.

Setup	
10*	Amplifier direct
11*	Amplifier plus 100 MHz filter
12*	Amplifier plus 150 MHz filter
13*	24 dB post attenuator
14*	24 dB post attenuator plus 150 MHz filter

\* Constants are stored after completing this setup.

- Using the numeric keypad or knob, adjust the displayed impedance at each setup to match the measured impedance. Select **ENTER VALUE**.
- There are no specific operational verification tests for output impedance. Continue with the next adjustment procedure in this section.

[Previous Calibration Topic](#)   [Next Calibration Topic](#)

### AC Amplitude (high-impedance) Adjustment - 33600 Series

The instrument stores a calibration constant for each high-impedance attenuator path. Each path's gain coefficient is calculated using two measurements: one with the waveform DAC at + output and one with waveform DAC at - output. The setups, therefore, must be performed in pairs.

- Connect the DMM to the channel output as shown below.

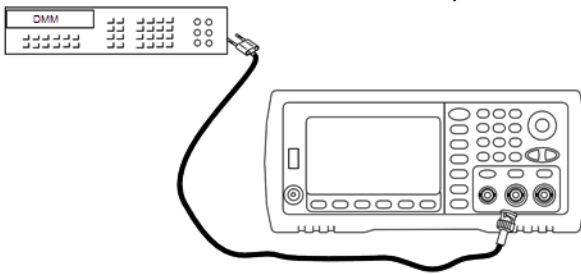

2. Use the DMM to measure the DC voltage at the front panel connector for each setup in the following table.

<b>Setup</b>	<b>Nominal Signal</b>	
	<b>DC Level</b>	
15	+0.0028 V	Output of -72 dB range
16*	-0.0028 V	Output of -72 dB range
17	+0.0068 V	Output of -64 dB range
18*	-0.0068 V	Output of -64 dB range
19	+0.0170 V	Output of -56 dB range
20*	-0.0170 V	Output of -56 dB range
21	+0.0430 V	Output of -48 dB range
22*	-0.0430 V	Output of -48 dB range
23	+0.1060 V	Output of -40 dB range
24*	-0.1060 V	Output of -40 dB range
25	+0.2680 V	Output of -32 dB range
26*	-0.2680 V	Output of -32 dB range
27	+0.6600 V	Output of -24 dB range
28*	-0.6600 V	Output of -24 dB range
29	+1.6500 V	Output of -16 dB range
30*	-1.6500 V	Output of -16 dB range
31	+4.2000 V	Output of -8 dB range
32*	-4.2000 V	Output of -8 dB range
33	+10.4000 V	Output of 0 dB range
34*	-10.4000 V	Output of 0 dB range
35	+0.0430 V	Output of -48 dB High DC range
36*	-0.0430V	Output of -48 dB High DC range
37	+0.1060 V	Output of -40 dB High DC range
38*	-0.1060 V	Output of -40 dB High DC range
39	+0.2680 V	Output of -32 dB High DC range



Setup	Nominal Signal	
	DC Level	
40*	-0.2680 V	Output of -32 dB High DC range
41	+0.6600 V	Output of -24 dB High DC range
42*	-0.6600 V	Output of -24 dB High DC range

\* Constants are stored after completing this setup.

- 3.
4. Using the numeric keypad or knob, adjust the displayed voltage at each setup to match the measured voltage. Select **ENTER VALUE**.
5. To proceed:
  - a. If your calibration procedures require you to verify this adjustment, exit the calibration menu and perform **AC Amplitude (high-impedance) Verification**.
  - b. If you are making all of the adjustments and then verifying the instrument's performance, continue with the next procedure in this section.

[Previous Calibration Topic](#)   [Next Calibration Topic](#)

## 1 Vpp Flatness Adjustment - 33600 Series

1. For frequencies up to and including 20 MHz, connect a precision AC voltmeter to measure the output amplitude as shown below. Connect the BNC cable to the Wide Band input of the Fluke 5790A.

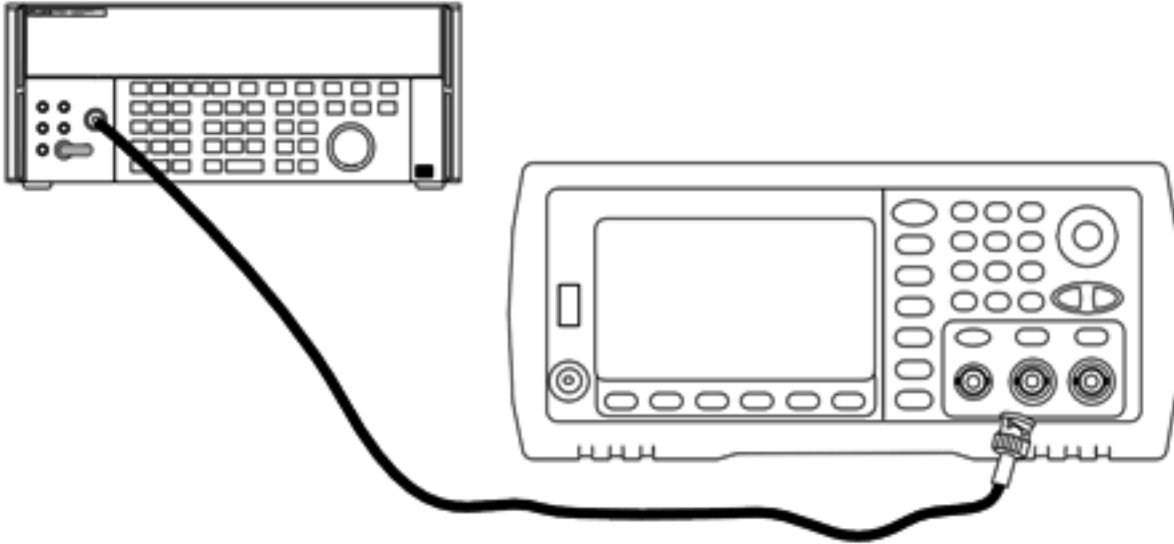

For frequencies above 20 MHz, connect a precision power sensor and power meter to measure the output amplitude as shown below.

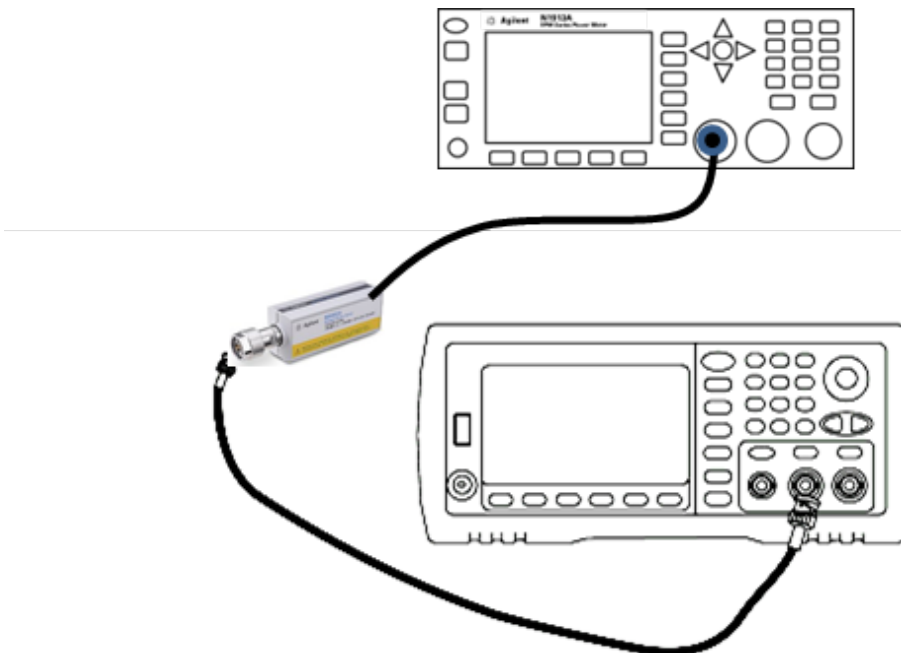

- Use the precision AC voltmeter to measure the output amplitude for each setup in the table below.

Setup	Nominal Signal		
	Frequency	Amplitude	
43*	1 kHz	380 mVrms	Flatness for 1 Vpp range
44*	100 kHz		
45*	1 MHz		
46*	5 MHz		
47*	10 MHz		
48*	20 MHz		
49*	25 MHz		
50*	30 MHz		
51	40 MHz		
52	50 MHz		
53	60 MHz		
54	70 MHz		
55	80 MHz		
56	90 MHz		
57	100 MHz		
58	110 MHz		
59	120 MHz		

\* Constants are stored after completing this setup.

- Using the numeric keypad or knob, adjust the displayed voltage at each setup to match the measured voltage. Select **ENTER VALUE**.
- To proceed:
  - If your calibration procedures require you to verify the adjustment just made, exit the calibration menu and perform **1 Vpp Range Flatness Verification**.
  - If you are making all of the adjustments and then verifying the instrument's performance, continue with the next procedure in this section.

[Previous Calibration Topic](#)   [Next Calibration Topic](#)

### 4 Vpp Flatness Adjustment - 33600 Series

1. For frequencies up to and including 20 MHz, connect a precision AC voltmeter to measure the output amplitude as shown below. Connect the BNC cable to the Wide Band input of the Fluke 5790A.

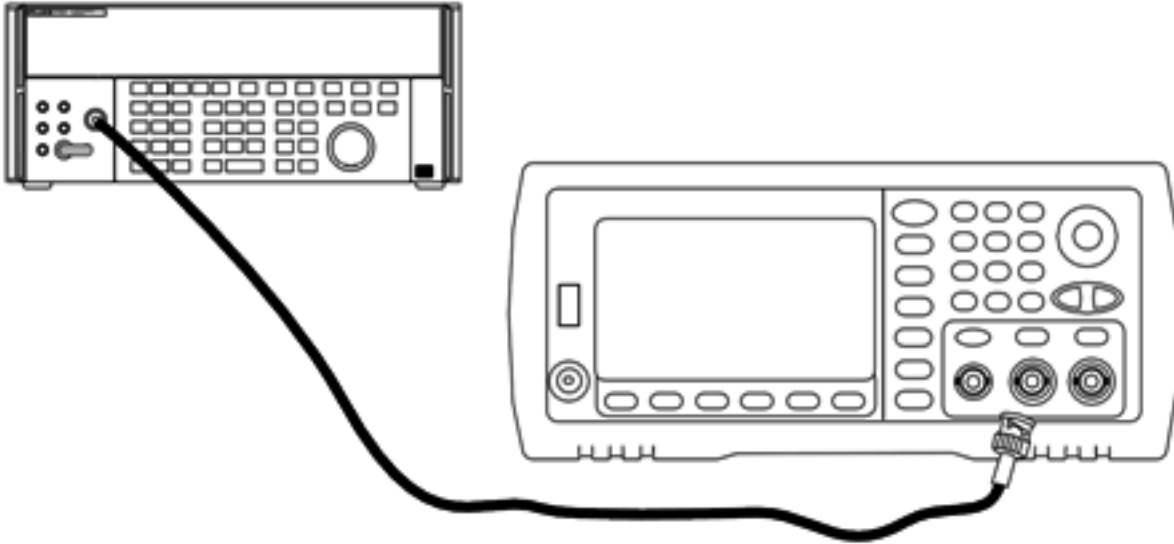

For frequencies above 20 MHz, connect a precision power sensor and power meter to measure the output amplitude as shown below.

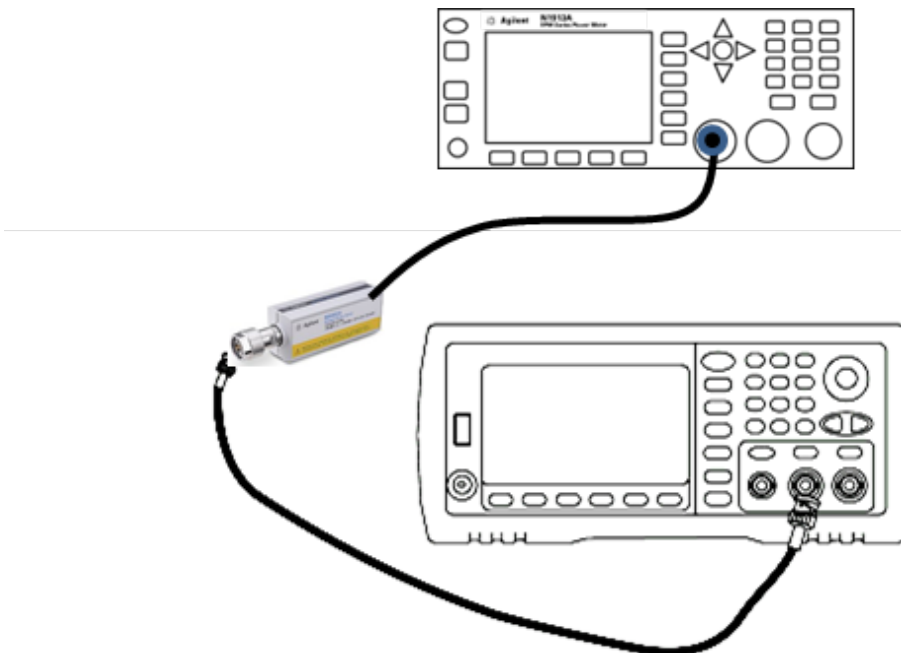

2. Use the precision AC voltmeter to measure the output amplitude for each setup in the table below.

Setup	Nominal Signal		
	Frequency	Amplitude	
60*	1 kHz	960 mVrms	Flatness for -8 dB range
61*	100 kHz		
62*	1 MHz		
63*	5 MHz		
64*	10 MHz		
65*	20 MHz		
66*	25 MHz		
67*	30 MHz		
68	40 MHz		
69	50 MHz		
70	60 MHz		
71	70 MHz		
72	80 MHz		
73	90 MHz		
74	100 MHz		
75	110 MHz		
76	120 MHz		

\* Constants are stored after completing this setup.

3. Using the numeric keypad or knob, adjust the displayed voltage at each setup to match the measured voltage. Select **ENTER VALUE**.
4. To proceed:
  - a. If your calibration procedures require you to verify the adjustment just made, exit the calibration menu and perform **4 Vpp Range Flatness Verification**.
  - b. If you are making all the adjustments and then verifying the instrument's performance, verify the output specifications of the instrument with the **Performance Verification Tests**.

This completes the adjustment procedures for the one-channel instrument. Verification of the output specifications is recommended.

If you are making adjustments to a two-channel instrument, continue with the next procedure in this section.

[Previous Calibration Topic](#)   [Next Calibration Topic](#)

## 8 Vpp Flatness Adjustment - 33600 Series

1. For frequencies up to and including 20 MHz, connect a precision AC voltmeter to measure the output amplitude as shown below. Connect the BNC cable to the Wide Band input of the Fluke 5790A.

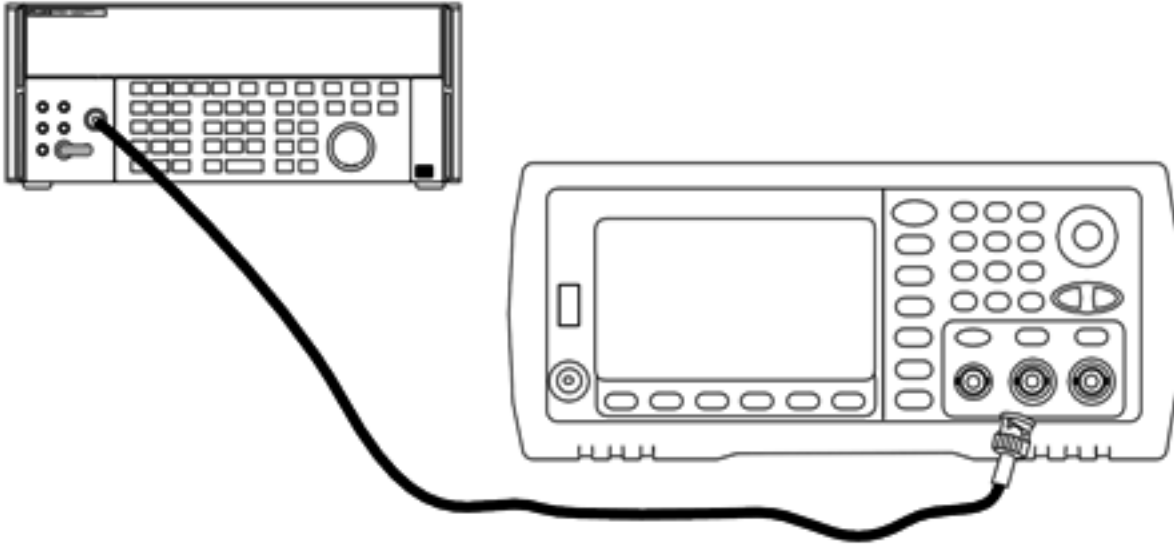

For frequencies above 20 MHz, connect a precision power sensor and power meter to measure the output amplitude as shown below.

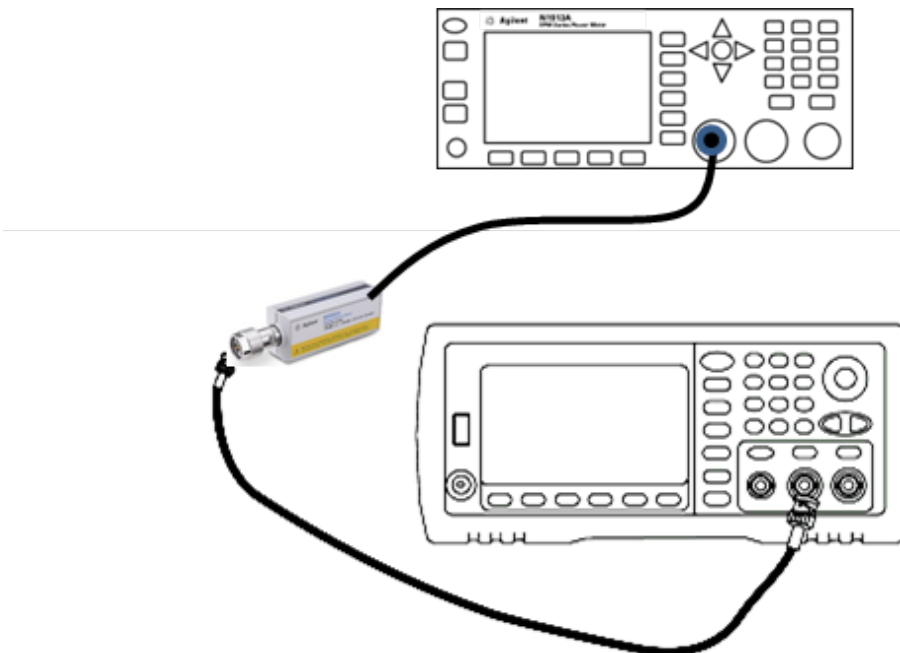

2. Use the precision AC voltmeter to measure the output amplitude for each setup in the table below.

Setup	Nominal Signal		
	Frequency	Amplitude	
77*	1 kHz	2.4 Vrms	Flatness for 0 dB range
78*	100 kHz		
79*	1 MHz		
80*	5 MHz		
81*	10 MHz		
82*	20 MHz		
83*	25 MHz		
84*	30 MHz		
85	40 MHz		
86	50 MHz		
87	60 MHz		
88	70 MHz		
89	80 MHz		

\* Constants are stored after completing this setup.

3. Using the numeric keypad or knob, adjust the displayed voltage at each setup to match the measured voltage. Select **ENTER VALUE**.
4. To proceed:
  - a. If your calibration procedures require you to verify the adjustment just made, exit the calibration menu and perform **8 Vpp Range Flatness Verification**.
  - b. If you are making all the adjustments and then verifying the instrument's performance, verify the output specifications of the instrument with the **Performance Verification Tests**.

This completes the adjustment procedures for the one-channel instrument. Verification of the output specifications is recommended.

If you are making adjustments to a two-channel instrument, continue with the next procedure in this section.

[Previous Calibration Topic](#)   [Next Calibration Topic](#)

## Channel 2 Adjustments - 33600 Series

The following topics describe calibration adjustments on channel 2.

- [Self Calibration Adjustment \(Channel 2\)](#)
- [Output Impedance Adjustment \(Channel 2\)](#)
- [AC Amplitude \(high-impedance\) Adjustment \(Channel 2\)](#)
- [-16 dB Range Flatness Adjustment \(Channel 2\)](#)
- [-8 dB Range Flatness Adjustment \(Channel 2\)](#)
- [0 dB Range Flatness Adjustment](#)

[Previous Calibration Topic](#)   [Next Calibration Topic](#)

### Self Calibration Adjustment (Channel 2) - 33600 Series

1. Enter and begin the following setup.

Setup	
90*	Self-calibration. The output is disabled.

\* Constants are stored after completing this setup.

2. To proceed:
  - a. If your calibration procedures require you to verify the adjustment just made, exit the calibration menu and perform [DC Offset Voltage Verification](#). Be sure to do this for channel 2.
  - b. If you are making all of the adjustments and then verifying the instrument's performance, continue with the next procedure in this section.

**NOTE**

This setup requires approximately 15 seconds to complete.

[Previous Calibration Topic](#)   [Next Calibration Topic](#)

### Output Impedance Adjustment (Channel 2) - 33600 Series

The instrument stores calibration constants for the channels' output impedance. These constants are generated with and without the post-amplifier attenuator.



1. Set the DMM to measure offset-compensated, four-wire Ohms. Set the DMM to use 100 NPLC integration. Connect the Ohms Source and Ohms Sense DMM inputs to the channel output as shown below.

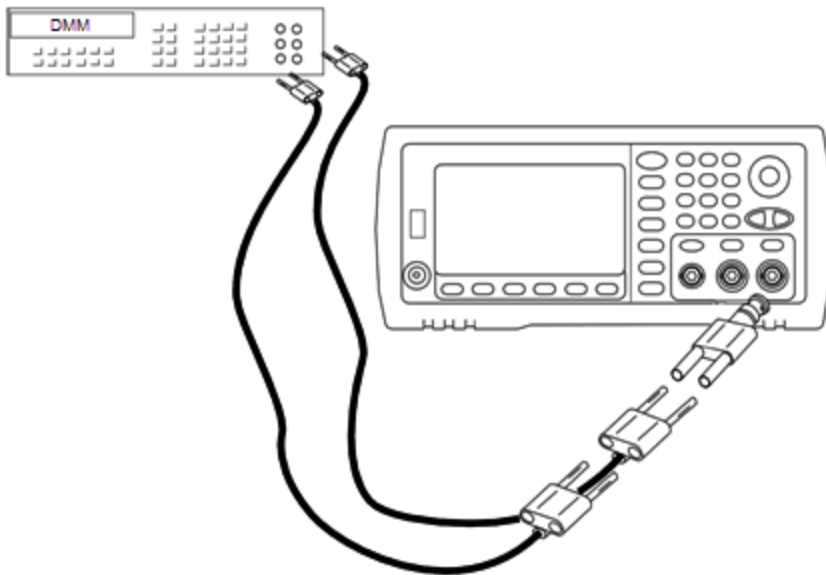

2. Use the DMM to make a 4-wire resistance measurement at the front panel output connector for each setup in the following table. The expected measured value is approximately 50  $\Omega$ .

3.

Setup	
91*	Amplifier direct
92*	Amplifier plus 100 MHz filter
93*	Amplifier plus 150 MHz filter
94*	24 dB post attenuator
95*	24 dB post attenuator plus 150 MHz filter

\* Constants are stored after completing this setup.

4. Using the numeric keypad or knob, adjust the displayed impedance at each setup to match the measured impedance. Select **ENTER VALUE**.
5. There are no specific operational verification tests for output impedance. Continue with the next adjustment procedure in this section.

[Previous Calibration Topic](#)   [Next Calibration Topic](#)

### AC Amplitude (high-impedance) Adjustment (Channel 2) - 33600 Series

The instrument stores a calibration constant for each high-impedance attenuator path. Each path's gain coefficient is calculated using two measurements: one with the waveform DAC at + output and one with waveform DAC at - output. The setups, therefore, must be performed in pairs.

1. Connect the DMM to the channel output as shown below.

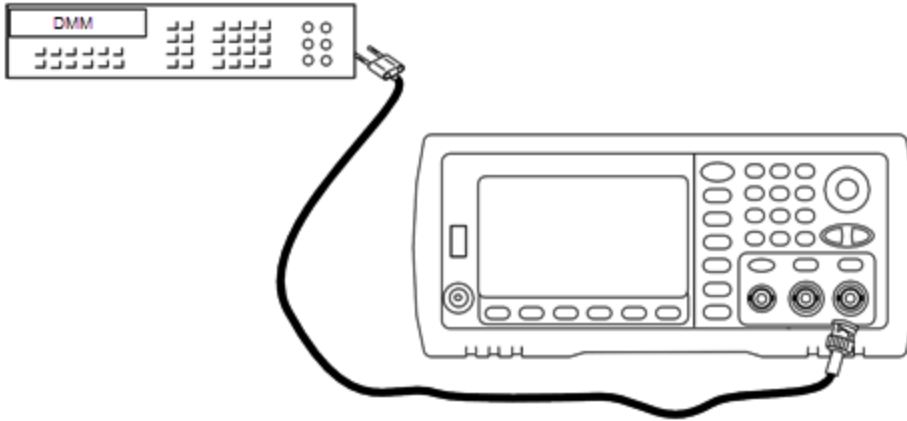

2. Use the DMM to measure the DC voltage at the front panel connector for each setup in the following table.

Service and Repair - Introduction

3.

<b>Setup</b>	<b>Nominal Signal</b>	
	<b>DC Level</b>	
96	+0.0028 V	Output of -72 dB range
97*	-0.0028 V	Output of -72 dB range
98	+0.0068 V	Output of -64 dB range
99*	-0.0068 V	Output of -64 dB range
100	+0.0170 V	Output of -56 dB range
101*	-0.0170 V	Output of -56 dB range
102	+0.0430 V	Output of -48 dB range
103*	-0.0430 V	Output of -48 dB range
104	+0.1060 V	Output of -40 dB range
105*	-0.1060 V	Output of -40 dB range
106	+0.2680 V	Output of -32 dB range
107*	-0.2680 V	Output of -32 dB range
108	+0.6600 V	Output of -24 dB range
109*	-0.6600 V	Output of -24 dB range
110	+1.6500 V	Output of -16 dB range
111*	-1.6500 V	Output of -16 dB range
112	+4.2000 V	Output of -8 dB range
113*	-4.2000 V	Output of -8 dB range
114	+10.4000 V	Output of 0 dB range
115*	-10.4000 V	Output of 0 dB range
116	+0.0430 V	Output of -48 dB High DC range
117*	-0.0430V	Output of -48 dB High DC range
118	+0.1060 V	Output of -40 dB High DC range
119*	-0.1060 V	Output of -40 dB High DC range
120	+0.2680 V	Output of -32 dB High DC range
121*	-0.2680 V	Output of -32 dB High DC range
122	+0.6600 V	Output of -24 dB High DC range
123*	-0.6600 V	Output of -24 dB High DC range

4.

\* Constants are stored after completing this setup.

5. Using the numeric keypad or knob, adjust the displayed voltage at each setup to match the measured voltage. Select **ENTER VALUE**.
6. To proceed:
  - a. If your calibration procedures require you to verify this adjustment, exit the calibration menu and perform **AC Amplitude (high-impedance) Verification**.
  - b. If you are making all of the adjustments and then verifying the instrument's performance, continue with the next procedure in this section.

[Previous Calibration Topic](#)   [Next Calibration Topic](#)

### 1 Vpp Flatness Adjustment (Channel 2) - 33600 Series

1. For frequencies up to and including 20 MHz, connect a precision AC voltmeter to measure the output amplitude as shown below. Connect the BNC cable to the Wide Band input of the Fluke 5790A.

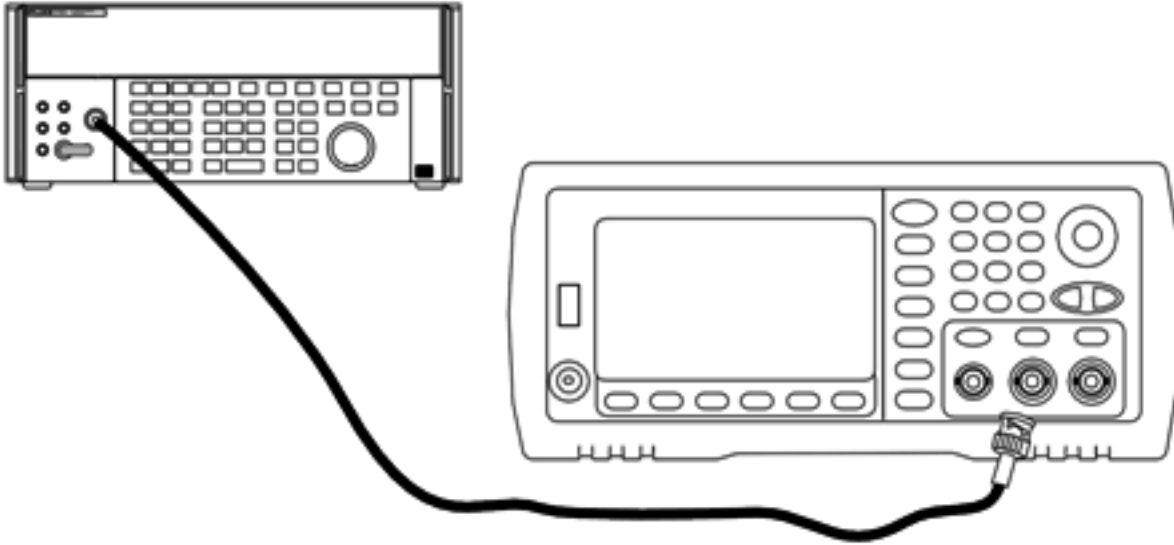

For frequencies above 20 MHz, connect a precision power sensor and power meter to measure the output amplitude as shown below.

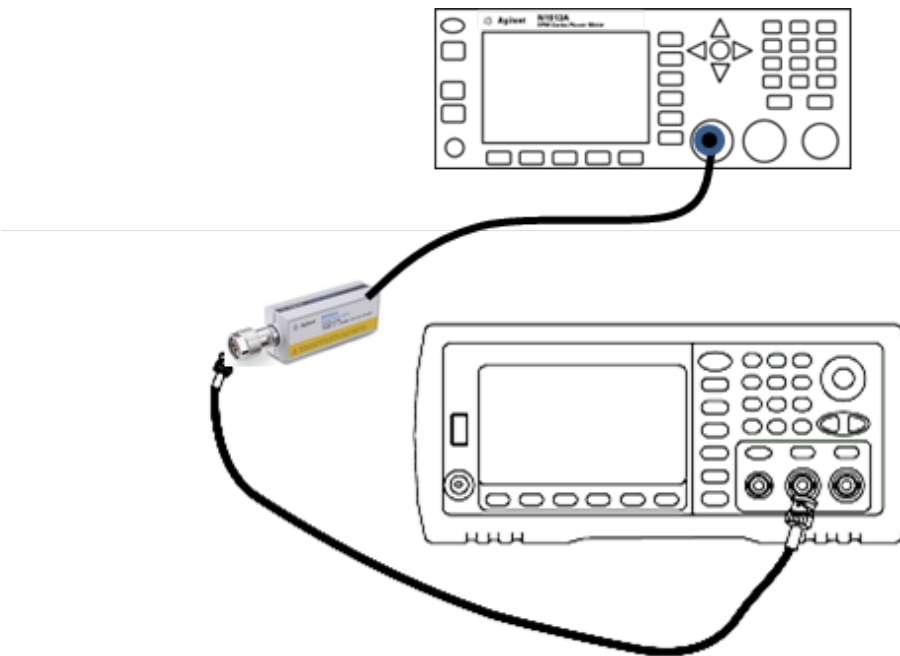

2. Use the precision AC voltmeter to measure the output amplitude for each setup in the table below.

Setup	Nominal Signal		
	Frequency	Amplitude	
124*	1 kHz	380 mVrms	Flatness for 1 Vpp range
125*	100 kHz		
126*	1 MHz		
127*	5 MHz		
128*	10 MHz		
129*	20 MHz		
130*	25 MHz		
131*	30 MHz		
132	40 MHz		
133	50 MHz		
134	60 MHz		
135	70 MHz		
136	80 MHz		
137	90 MHz		
138	100 MHz		
139	110 MHz		
140	120 MHz		

\* Constants are stored after completing this setup.

3. Using the numeric keypad or knob, adjust the displayed voltage at each setup to match the measured voltage. Select **ENTER VALUE**.
4. To proceed:
- If your calibration procedures require you to verify the adjustment just made, exit the calibration menu and perform **1 Vpp Range Flatness Verification**. Be sure that you do this for Channel 2.
  - If you are making all of the adjustments and then verifying the instrument's performance, continue with the next procedure in this section.

[Previous Calibration Topic](#)   [Next Calibration Topic](#)

#### 4 Vpp Flatness Adjustment (Channel 2) - 33600 Series

This section applies to channel 2. It checks high frequency AC amplitude flatness on the -8 dB attenuator range. It also checks flatness for all other ranges excluding the -24 dB and 0 dB attenuator ranges.

1. For frequencies up to and including 20 MHz, connect a precision AC voltmeter to measure the output amplitude as shown below. Connect the BNC cable to the Wide Band input of the Fluke 5790A.

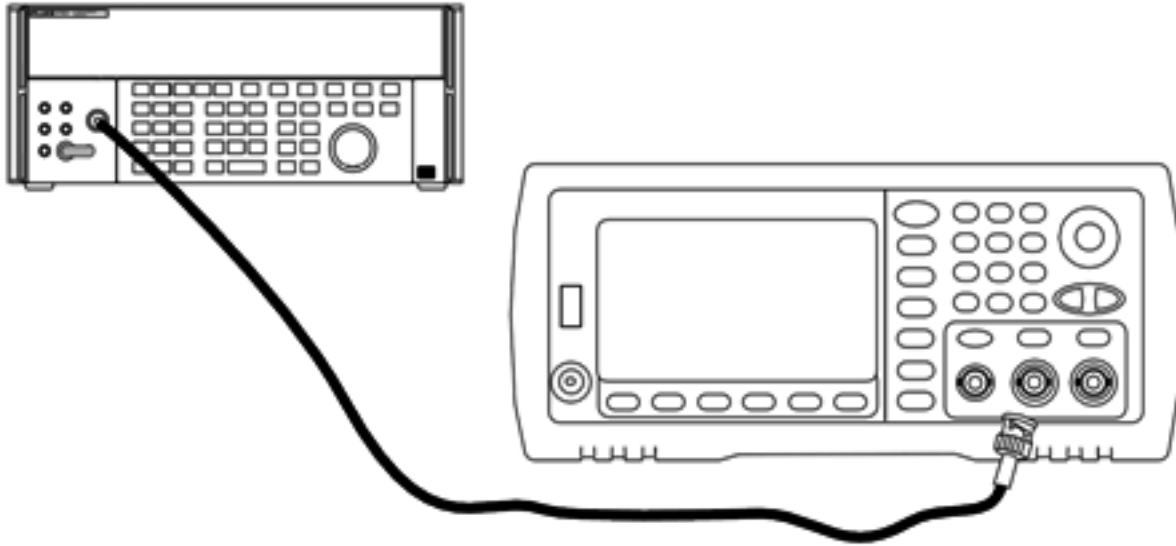

For frequencies above 20 MHz, connect a precision power sensor and power meter to measure the output amplitude as shown below.

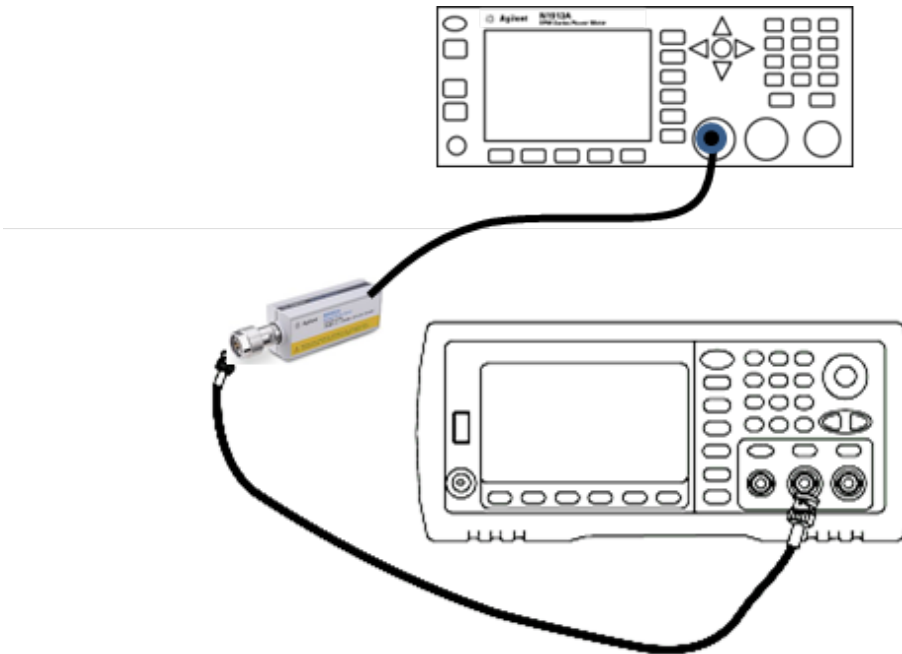

2. Use the precision AC voltmeter to measure the output amplitude for each setup in the table below.

Setup	Nominal Signal		
	Frequency	Amplitude	
141*	1 kHz	960 mVrms	Flatness for -8 dB range
142*	100 kHz		
143*	1 MHz		
144*	5 MHz		
145*	10 MHz		
146*	20 MHz		
147*	25 MHz		
148*	30 MHz		
149	40 MHz		
150	50 MHz		
151	60 MHz		
152	70 MHz		
153	80 MHz		
154	90 MHz		
155	100 MHz		
156	110 MHz		
157	120 MHz		

\* Constants are stored after completing this setup.

3. Using the numeric keypad or knob, adjust the displayed voltage at each setup to match the measured voltage. Select **ENTER VALUE**.
4. You have now completed the recommended adjustment procedures. Verification of the output specifications is recommended.
  - a. If your calibration procedures require you to verify the adjustment just made, exit the calibration menu and perform **4 Vpp Range Flatness Verification**.

[Previous Calibration Topic](#)   [Next Calibration Topic](#)



### 8 Vpp Flatness Adjustment - 33600 Series

1. For frequencies up to and including 20 MHz, connect a precision AC voltmeter to measure the output amplitude as shown below. Connect the BNC cable to the Wide Band input of the Fluke 5790A.

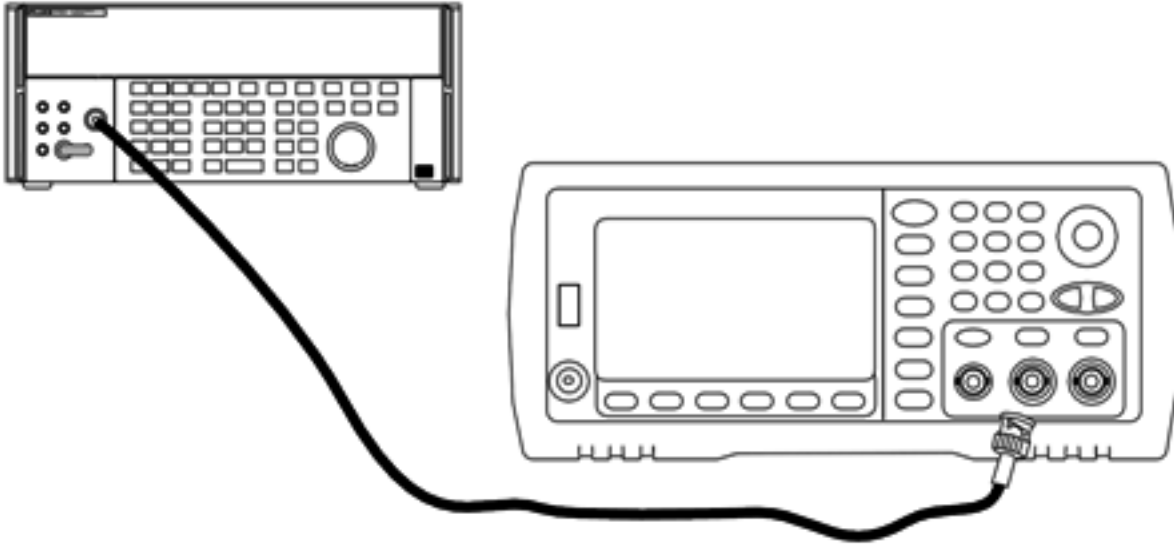

For frequencies above 20 MHz, connect a precision power sensor and power meter to measure the output amplitude as shown below.

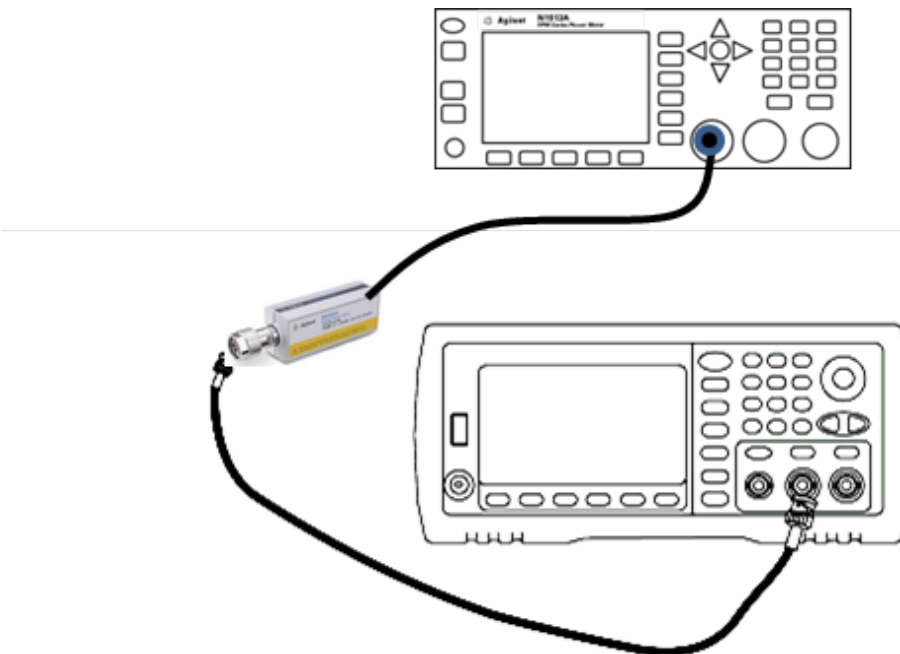

2. Use the precision AC voltmeter to measure the output amplitude for each setup in the table below.

Setup	Nominal Signal		
	Frequency	Amplitude	
158*	1 kHz	2.4 Vrms	Flatness for 0 dB range
159*	100 kHz		
160*	1 MHz		
161*	5 MHz		
162*	10 MHz		
163*	20 MHz		
164*	25 MHz		
165*	30 MHz		
166	40 MHz		
167	50 MHz		
168	60 MHz		
169	70 MHz		
170	80 MHz		

\* Constants are stored after completing this setup.

3. Using the numeric keypad or knob, adjust the displayed voltage at each setup to match the measured voltage. Select **ENTER VALUE**.
4. To proceed:
  - a. If your calibration procedures require you to verify the adjustment just made, exit the calibration menu and perform **8 Vpp Range Flatness Verification**.
  - b. If you are making all the adjustments and then verifying the instrument's performance, verify the output specifications of the instrument with the **Performance Verification Tests**.

This completes the adjustment procedures for the one-channel instrument. Verification of the output specifications is recommended.

If you are making adjustments to a two-channel instrument, continue with the next procedure in this section.

[Previous Calibration Topic](#)   [Next Calibration Topic](#)

## Calibration Errors - 33600 Series

The following errors may occur during calibration. There are also **system errors** and **self-test errors**. Some error messages include a failing channel number (1 or 2), shown as n in the messages below.

### **701 Calibration error; security defeated by hardware jumper**

If you short the calibration secure jumper (CAL ENABLE) while turning the instrument on, this error indicates the security password has been overwritten. See **Calibration Security** for details.

### **702 Calibration error; calibration memory is secured**

To perform calibration, unsecure the instrument. See **Calibration Security** for details.

### **703 Calibration error; secure code provided was invalid**

Specified security code was invalid.

### **706 Calibration error; value out of range**

Value entered was outside valid range.

### **707 Calibration error; signal input is out of range**

Occurs during the ADC Adjustment, setup 6, if the 1 V input voltage is too high. May also occur during self-calibration (setup 7). Run self-test to diagnose problem.

### **710 Self-calibration failed; Chan n, null DAC cal, invalid self cal**

**Self-calibration failed; Chan n, offset DAC cal with attenuator, invalid self cal**

**Self-calibration failed; Chan n, offset DAC cal no attenuator, invalid self cal**

Error occurred while performing internal calibration of specified DAC. Self-calibration exited without changing self-calibration constants. Run self-test to diagnose problem.

### **711 Self-calibration failed; Chan n, null DAC cal gain too low (too high), <meas\_value>**

**Self-calibration failed; Chan n, offset DAC cal with attenuator gain too low (too high), <meas\_value>**

**Self-calibration failed; Chan n, offset DAC cal no attenuator gain too low (too high), <meas\_value>**

Computed gain calibration factor for specified DAC was out of limits. Self-calibration exited without changing self-calibration constants. Run self-test to diagnose problem.

### **712 Self-calibration failed; Chan n, null DAC cal zero too low (too high), <meas\_value>**

**Self-calibration failed; Chan n, offset DAC cal with attenuator zero too low (too high), <meas\_value>**

**Self-calibration failed; Chan n, offset DAC cal no attenuator zero too low (too high), <meas\_value>**

**Self-calibration failed; Chan n, GND measurement out of limits, <meas\_value>**

Computed zero calibration factor for specified DAC was out of limits. Self-calibration exited without changing self-calibration constants. Run self-test to diagnose problem.

### **715 Self-calibration failed; Chan n, null DAC cal, convergence error sub attenuator value dB**

Internal null DAC calibration failed to converge during internal calibration. Self-calibration exited without changing self-calibration constants. Run self-test to diagnose problem.

**720 Self-calibration failed; Chan n, offset DAC cal with attenuator, convergence error**  
**Self-calibration failed; Chan n, offset DAC cal no attenuator, convergence error**

Internal offset DAC calibration failed to converge internal calibration. Self-calibration exited without changing self-calibration constants. Run self-test to diagnose problem.

**850 Calibration error; set up is invalid**

Invalid calibration setup number selected.

**850 Calibration error; set up is out of order**

Certain calibration steps require a specific beginning and ending. Do not enter into the middle of a calibration sequence.

**Previous Calibration Topic**

## Block Diagram - 33500 Series

The instrument has four main assemblies:

- Processor
- Main board
- Front panel
- Main power supply

A **simplified block diagram** appears at the bottom of this section.

The processor is a single board computer that contains the CPU, RAM, ROM, and circuits used to drive the GPIB, LAN, and USB ports. The built in web interface is contained in the ROM. The processor circuitry is earth referenced.

When the power switch is pressed, the processor communicates with and loads the FPGA. This communication uses three asynchronous serial data lines and one serial clock line. These four lines are isolated.

The FPGA stores all waveforms except arbitrary waveforms. Arbitrary waveforms are loaded into SDRAM on the main board. All control of waveforms, triggers, sync signals, output path, attenuation, and offset is provided by the FPGA.

The main waveform for each channel (only one channel is shown in the **block diagram**) is loaded into the waveform DAC and clocked by the timebase. The DAC output passes through an elliptical filter before the main attenuators. There are three attenuators available in the path, -7.96 dB, -15.91 dB, and -23.87 dB.

The signal is applied to the output amplifier. The DC offset is summed at the output amplifier. A post amplifier -23.87 dB attenuator is available for low level signals. The table below show the attenuators that create the output signal amplitude.

<b>Output Range DC Offset &lt; 320 mV</b>	<b>-7.96 dB</b>	<b>-15.91 dB</b>	<b>-23.87 dB</b>	<b>-23.87 dB (post)</b>
10 Vpp - 3.6 Vpp	Out	Out	Out	Out
4 Vpp - 1.44 Vpp	In	Out	Out	Out
1.6 Vpp - 576 mVpp	Out	In	Out	Out
640 mVpp - 230 mVpp	Out	Out	Out	In
256 mVpp - 92 mVpp	In	Out	Out	In
102.4 mVpp - 36.86 mVpp	Out	In	Out	In
40.96 mVpp - 14.75 mVpp	Out	Out	In	In
16.38 mVpp - 5.90 mVpp	In	Out	In	In
6.55 mVpp - 2.36 mVpp	Out	In	In	In
2.62 mVpp - 1.00 mVpp	In	In	In	In

<b>Output Range DC Offset ≥ 320 mV</b>	<b>-7.96 dB</b>	<b>-15.91 dB</b>	<b>-23.87 dB</b>	<b>-23.87 dB (post)</b>
9.36 Vpp - 3.6 Vpp	Out	Out	Out	Out
4 Vpp - 1.44 Vpp	In	Out	Out	Out
1.6 Vpp - 576 mVpp	Out	In	Out	Out
640 mVpp - 230 mVpp	Out	Out	In	Out
256 mVpp - 92 mVpp	In	Out	In	Out
102.4 mVpp - 36.86 mVpp	Out	In	In	Out
40.96 mVpp - 1.00 mVpp	In	In	In	Out

The output relay when enabled provides the waveform to the front panel BNC connector. Additionally, this relay, when disabled, routes the signal to the Modulation ADC for internal self-test and calibration routines.

The output relay is controlled by the FPGA. Two circuits provide overvoltage and over current protection, primarily from an external circuit. The instrument can source very low output impedances.

The **Sync** output signal is generated as a waveform from the FPGA to the **Sync** DAC.

External trigger in and out is chassis referenced at the BNC connector but is isolated before the FPGA.

Modulation in is an isolated input to the A/D converter. The FPGA applies the modulation signal to the output waveform.

The instrument's clock generator employs a 10-MHz crystal oscillator and a phase-locked loop to generate the 250-MHz clocks used by the FPGA and Waveform DACs. When an external 10-MHz frequency reference is used, a digital phase-locked loop in the FPGA keeps the crystal oscillator in sync.

### Block Diagram - 33500 Series

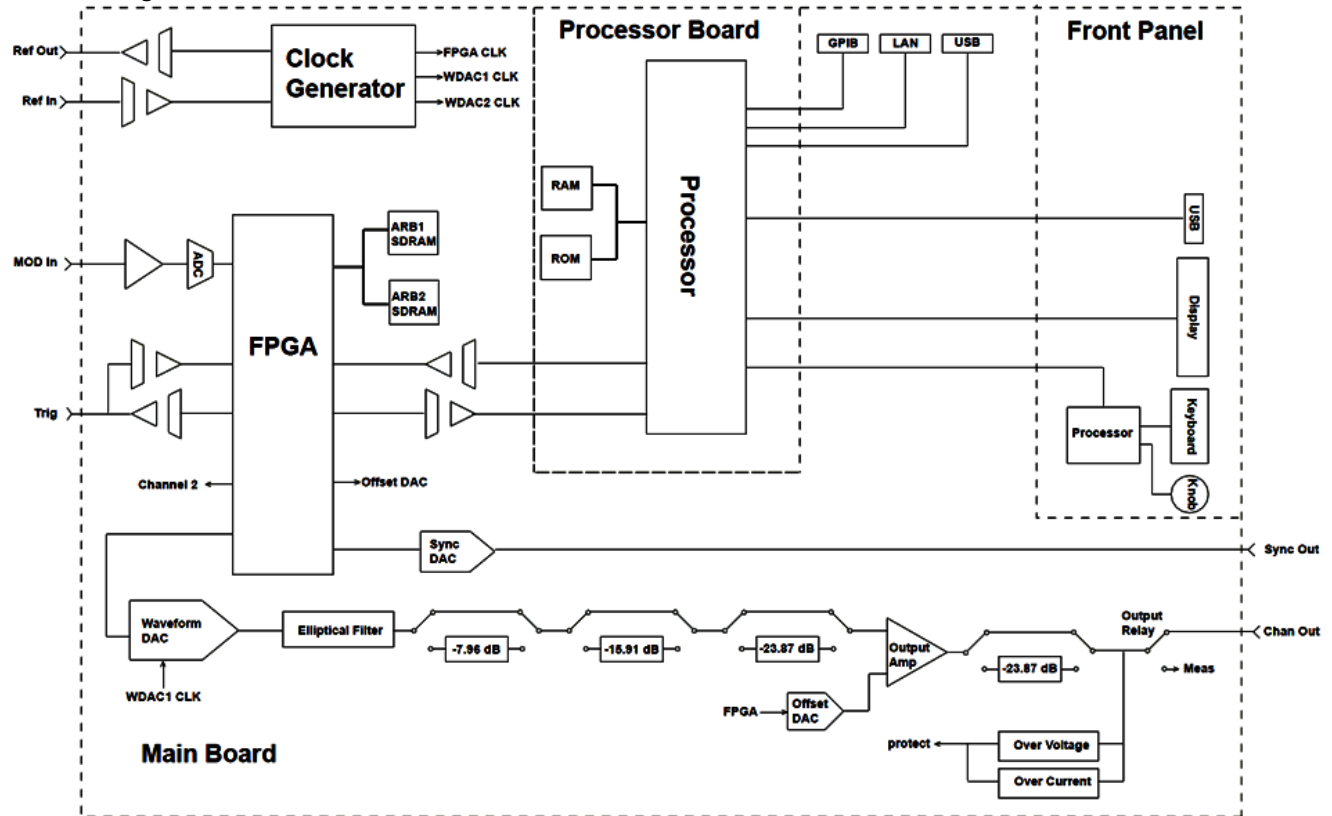

### Block Diagram - 33600 Series

The instrument has four main assemblies:

- Processor
- Main board
- Front panel
- Main power supply

A **simplified block diagram** appears at the bottom of this section.

The processor is contained within the Front Panel Assembly, and contains the CPU, RAM, and ROM, as well as circuits used to drive the GPIB, LAN, and USB ports. The built in web interface is contained in the ROM. The processor circuitry is earth referenced.

When the power switch is pressed, the processor communicates with and loads the FPGA on the Mezzanine Assembly. This communication uses three asynchronous serial data lines and one serial clock line. These four lines are isolated.

The FPGA stores all waveforms except arbitrary waveforms. Arbitrary waveforms are loaded into SDRAM on the Mezzanine Assembly. All control of waveforms, triggers, sync signals, output path, attenuation, and offset is provided by the FPGA.

The main waveform for each channel (only one channel is shown in the **block diagram**) is loaded into the waveform DAC and clocked by the Clock Generator. The DAC output passes through an Anti-Alias Filter before the main attenuators. There are three attenuators available in the path, -7.96 dB, -15.91 dB, and -23.87 dB.

The signal is applied to the output amplifier. The DC offset is summed at the output amplifier. A post amplifier -23.87 dB attenuator is available for low level signals. The table below show the attenuators that create the output signal amplitude.

<b>Output Range DC Offset &lt; 320 mV</b>	<b>-7.96 dB</b>	<b>-15.91 dB</b>	<b>-23.87 dB</b>	<b>-23.87 dB (post)</b>
10 Vpp - 4.0001 Vpp	Out	Out	Out	Out
4.1 Vpp - 1.44 Vpp	In	Out	Out	Out
1.6 Vpp - 576 mVpp	Out	In	Out	Out
640 mVpp - 230 mVpp	Out	Out	Out	In
256 mVpp - 92 mVpp	In	Out	Out	In
102.4 mVpp - 36.86 mVpp	Out	In	Out	In
40.96 mVpp - 14.75 mVpp	Out	Out	In	In
16.38 mVpp - 5.90 mVpp	In	Out	In	In
6.55 mVpp - 2.36 mVpp	Out	In	In	In
2.62 mVpp - 1.00 mVpp	In	In	In	In

<b>Output Range DC Offset ≥ 320 mV</b>	<b>-7.96 dB</b>	<b>-15.91 dB</b>	<b>-23.87 dB</b>	<b>-23.87 dB (post)</b>
9.36 Vpp - 3.6 Vpp	Out	Out	Out	Out
4 Vpp - 1.44 Vpp	In	Out	Out	Out
1.6 Vpp - 576 mVpp	Out	In	Out	Out
640 mVpp - 230 mVpp	Out	Out	In	Out
256 mVpp - 92 mVpp	In	Out	In	Out
102.4 mVpp - 36.86 mVpp	Out	In	In	Out
40.96 mVpp - 1.00 mVpp	In	In	In	Out
DC Volts function < 320 mV	In	In	In	In

<b>Output Range DC Offset <math>\geq</math> 320 mV</b>	<b>-7.96 dB</b>	<b>-15.91 dB</b>	<b>-23.87 dB</b>	<b>-23.87 dB (post)</b>
DC Volts function $\geq$ 320 mV	In	In	In	Out

Two relays in the Output Switching and Filters block provide three paths to the front panel BNC connector (one straight-through and two through filters that reduce output distortion) as well as an open path to disable the output. An attenuated version of the output is fed to the Modulation ADC to be used for internal self-test and calibration.

The output relays are controlled by the FPGA. Two circuits provide overvoltage and over current protection, primarily from an external circuit. The instrument can source very low output impedances.

The **Sync** output signal is generated as a waveform from the FPGA to the **Sync** DAC.

External trigger in and out is chassis referenced at the BNC connector but is isolated before the FPGA.

Modulation In is an input to the A/D converter. The FPGA applies the modulation signal to the output waveform.

The instrument's clock generator employs a 10-MHz crystal oscillator and a phase-locked loop to generate the 2-GHz clocks used by the FPGA and Waveform DACs. When an external 10-MHz frequency reference is used, a phase-locked loop in the FPGA keeps the crystal oscillator in sync.



### Block Diagram - 33600 Series

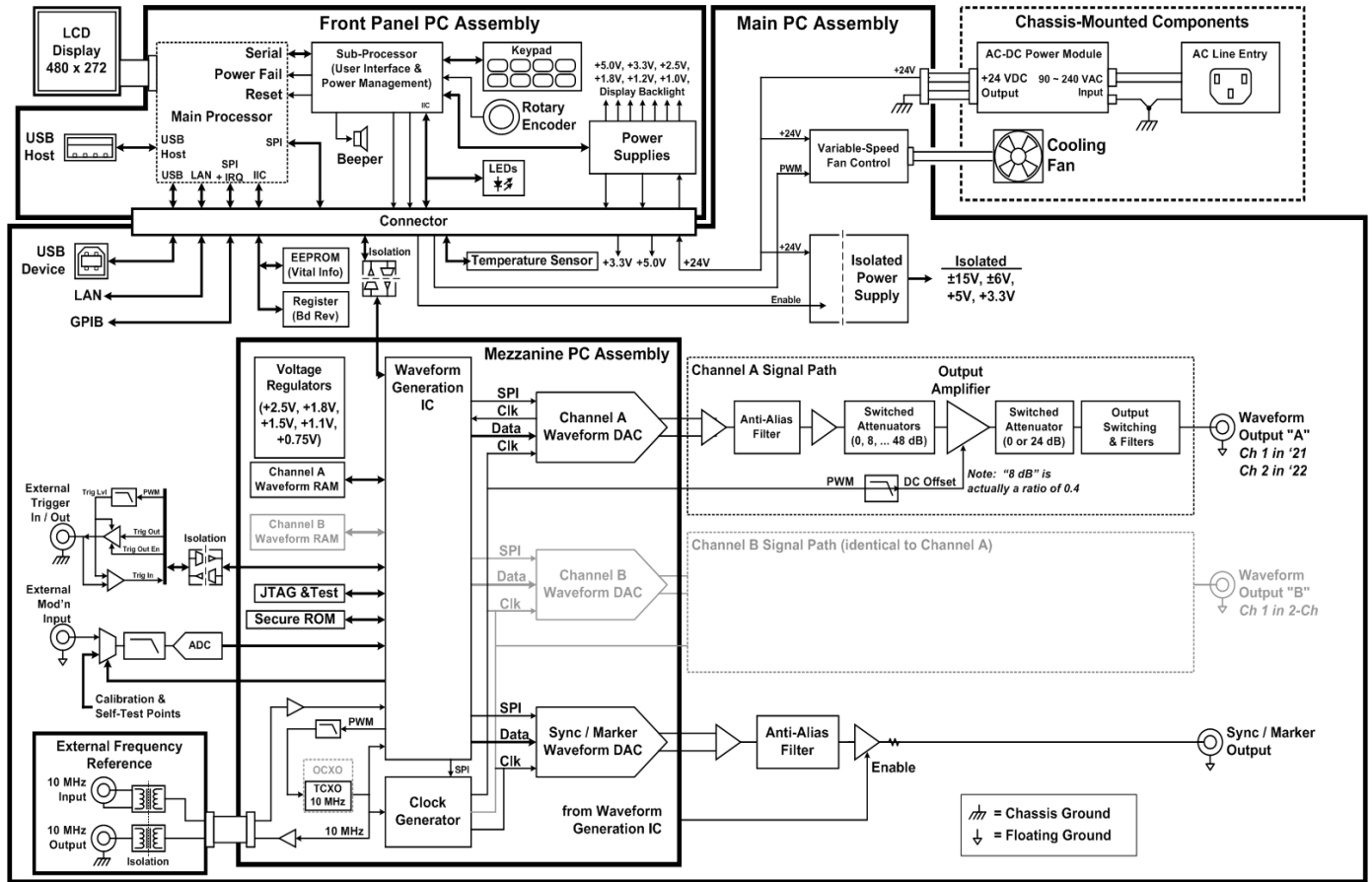

### Power Supplies - 33500 Series

The line voltage is filtered and applied to the main power supply, a +15 V supply that is always on when line power is applied. A regulator creates an earth referenced +3.3 V supply from the main supply, and this is also always active when line power is applied.

A small microprocessor on the main board senses the power switch and enables all other supplies.

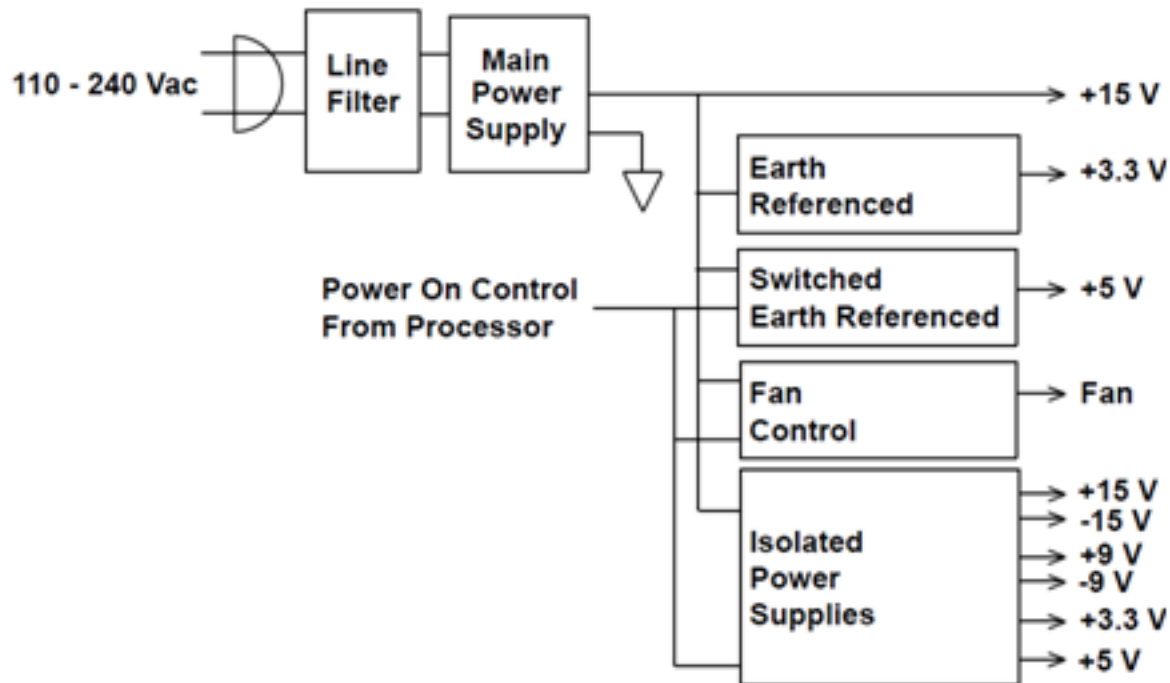

### Power Supplies - 33600 Series

The line voltage is filtered and applied to the main power supply, a +24 V supply that is always on when line power is applied. A regulator creates an earth referenced +5 V supply from the main supply, and this is also always active when line power is applied.

A small microprocessor on the front panel senses the power switch and enables all other supplies.

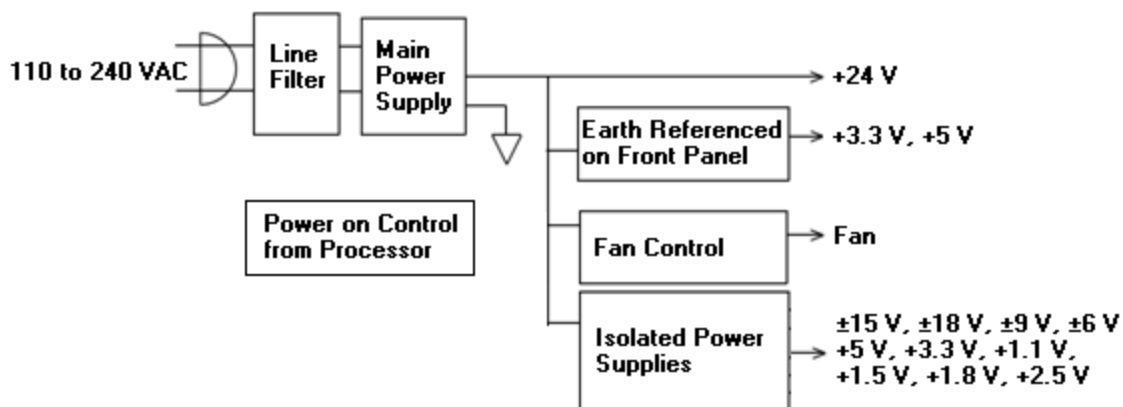

### Troubleshooting - 33500 Series

A brief list of common failures appears below. Before troubleshooting or repairing the instrument, make sure the failure is in the instrument rather than any external connections. Also make sure that the instrument was accurately calibrated within the last year. The instrument's circuits allow troubleshooting and repair with basic test equipment.

## Unit is Inoperative

Verify that:

- the AC power cord is securely connected to the instrument and plugged into a live outlet
- the front panel Power On/Standby switch has been pushed

## Unit Fails Self-Test

Ensure that all connections (front and rear) are removed when self-test is performed. During self-test, errors may be induced by signals present on external wiring, such as long test leads that can act as antennas.

### CAUTION

DO NOT swap the motherboard, the processor board, or the front panel board from one instrument to another. These boards contain model number and serial number information that uniquely identifies a specific unit, and boards that are mismatched to the instrument may result in problems with its performance, licensing, serviceability, importability/exportability or warranty.

## Power Supplies

Verify the main power supply.

### WARNING

Shock Hazard. To check the power supplies, remove the instrument cover as described in [Disassembly](#).

The main power supply provides a +15 VDC ( $\pm 0.3$  VDC) supply to the main circuit board. All other supplies are derived from this supply. This supply is energized at all times while the line power cord is connected.

Test the supply at the connector to the main board. Note that the supply is not referenced to the chassis when disconnected from the main board.

- Circuit failure can cause heavy supply loads which may pull down the supply output voltage. Disconnect the main supply from the main board to test.
- Always check the supply is free of oscillations using an oscilloscope.
- The main power supply contains a fuse. Replacing this fuse is not recommended. Replace the entire main power supply assembly. Note that power supply failures are often caused by other instrument failures.

### CAUTION

The heat sinks on the main board are at different potentials. Damage may occur if any of the heat sinks are shorted together. Use care when probing the main board.

Verify the power supplies listed in the table below and shown in the [power supply block diagram](#). Earth referenced supplies may be tested using the chassis as ground. Isolated supplied may be tested by using one of the heat sinks shown in the figure.

Supply			
+3.3 V ER*	+15 V Isolated	+9 V Isolated	+3.3 V Isolated
+5 ER	-15 V Isolated	-9 V Isolated	+5 V Isolated

\* This supply is active whenever AC power is applied to the instrument.

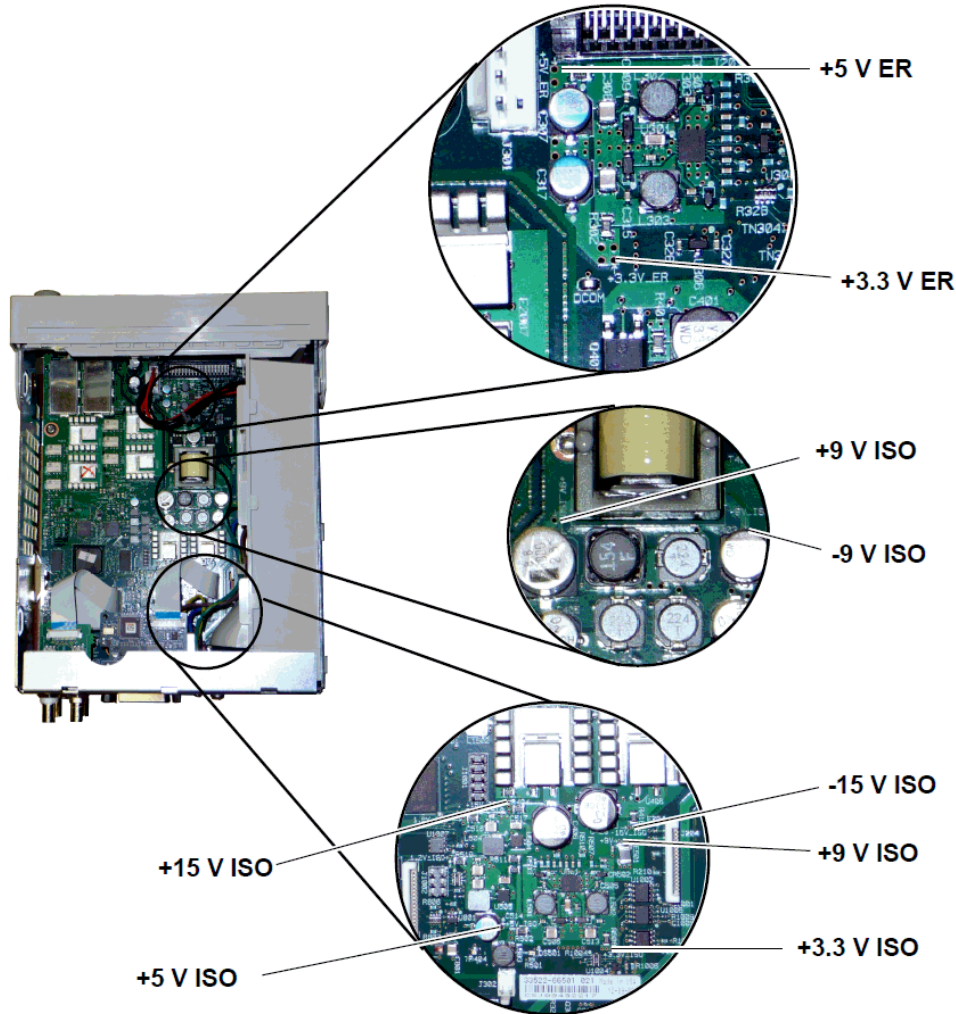

### Self-Test Errors 605 - 609

Self-test errors 605-609 indicate that the processor board is unable to correctly program or communicate with the waveform FPGA (U1005) on the main board. In this case, further troubleshooting is required. The problem could be due to out of date firmware, or a failing or unseated processor board or main board. Before troubleshooting these errors, ensure that the instrument firmware is up to date. If the errors are still being reported, continue with the following procedure.

#### Reseat the Boards

Power off the unit, remove the cover. Reseat the processor board and the main board. Power up the unit and see if the errors 605-609 are still reported at power-on.

### Check Power Supplies

Probe the system power supplies and verify they are operating within limits. If any of the power supplies are out of limit, diagnose the power supply. Otherwise, continue on to check SPI communications.

### Check SPI Communications

If you still see errors after reseating the boards, the next step is to probe the SPI communications lines between the processor board and the main board. First, locate LED DS1001 on the main board as shown below. Cycle power on the unit, wait until it fully boots, and see whether the main board LED illuminates. The main board LED indicates whether the FPGA was successfully programmed. The following sections indicate which signal lines to probe on the main board connector (J201).

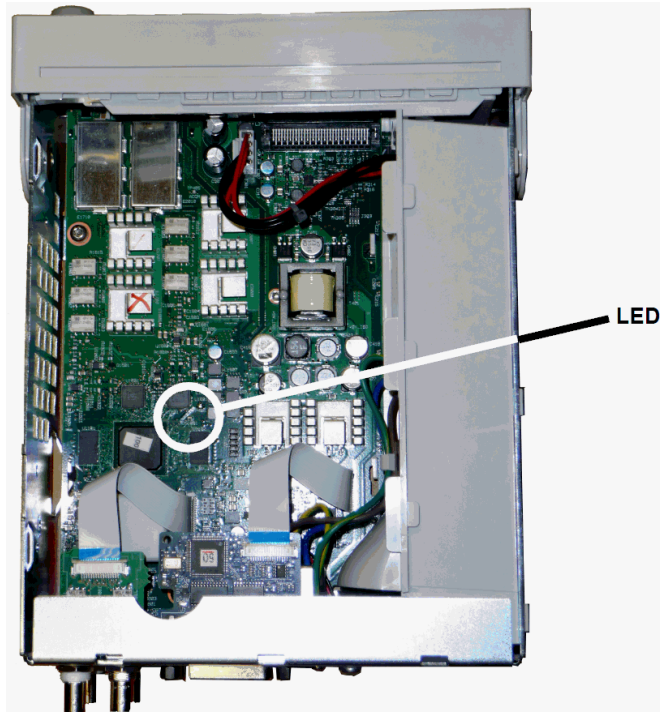

### Main Board LED Lights up after Boot

This indicates that the FPGA is programmed and running. Most likely there is a communications failure from the main board to the processor board. Probe the J201, pin 27 line with an oscilloscope, and cycle power on the unit (wait for full boot) to see if there is activity on the line. Activity should be +3.3 V pulses (isolated). Note that activity ceases once the instrument is booted.

- If there is no activity on the line even after the LED lights up, then most likely the main board is the cause of the failure.
- If there is activity on the line, then the processor board is the most likely cause of the failure.

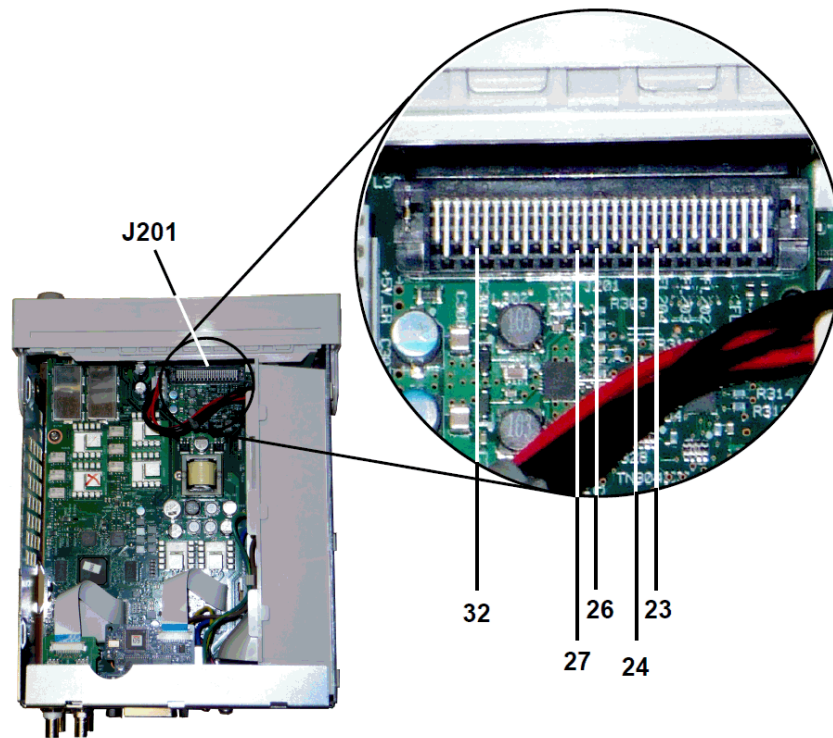

### Main Board LED Does not Light up after Boot

This indicates that the processor was unable to program the FPGA. Most likely there is a communications failure from the processor board to the main board. Probe the following serial data lines at power up with an oscilloscope:

- J201, pin 23
- J201, pin 24
- J201, pin 26
- J201, pin 32

If all of the above SPI lines show activity during FPGA programming, then the main board is the most likely cause of the failure. Otherwise, the processor board is the most likely cause.

### 10 MHz Out

If the power supplies are functional and self-test passes, check the 10 MHz output at the rear panel. This output is present whenever the instrument has powered on and the processor and main board are operational. If the 10 MHz is present, but the display is not working, suspect the front panel board or display assembly.

## Troubleshooting - 33600 Series

A brief list of common failures appears below. Before troubleshooting or repairing the instrument, make sure the failure is in the instrument rather than any external connections. Also make sure that the

instrument was accurately calibrated within the last year. The instrument's circuits allow troubleshooting and repair with basic test equipment.

### Unit is Inoperative

Verify that:

- the AC power cord is securely connected to the instrument and plugged into a live outlet
- the front panel Power On/Standby switch has been pushed

### Unit Fails Self-Test

Ensure that all connections (front and rear) are removed when self-test is performed. During self-test, errors may be induced by signals present on external wiring, such as long test leads that can act as antennas.

#### CAUTION

DO NOT swap the motherboard, the processor board, or the front panel board from one instrument to another. These boards contain model number and serial number information that uniquely identifies a specific unit, and boards that are mismatched to the instrument may result in problems with its performance, licensing, serviceability, importability/exportability or warranty.

### Power Supplies

Verify the main power supply.

#### WARNING

Shock Hazard. To check the power supplies, remove the instrument cover as described in [Disassembly](#).

The main power supply assembly provides a +24 VDC supply to the main circuit board. All other supplies are derived from this supply. This supply is energized at all times while the line power cord is connected.

#### CAUTION

Test the supply at the connector to the main board. Note that the supply is not referenced to the chassis when disconnected from the main board. If the connector is connected to the main board, ensure that the main board mounting screw is in place and the AC inlet ground (green/yellow wire) is connected to the chassis.

- Circuit failure can cause heavy supply loads which may pull down the supply output voltage. Disconnect the main supply from the main board to test.
- Always check the supply output is free of oscillations using an oscilloscope.

#### CAUTION

The main power supply contains two fuses. Replacing these fuses is not recommended. Replace the entire main power supply assembly. Note that power supply failures are often caused by other instrument failures.

#### CAUTION

The heat sinks on the main board are at different potentials. Damage may occur if any of the heat sinks are shorted together. Use care when probing the main board.

### Main Board Power Supplies

Verify the power supplies listed in the table below and shown in the **power supply block diagram**. Earth referenced supplies may be tested using the chassis as ground. Isolated supplied may be tested by using one of the heat sinks.

The line voltage is filtered and applied to the main power supply, a +24 V ( $\pm 0.3$  VDC) supply that is always on when line power is applied. Regulators on the front panel board create earth referenced +5 V and +3.3 V supplies from the main supply, which are also always active when line power is applied.

Main board LEDs illuminate at power-on to indicate that the +5 V Isolated and +3.3 V Isolated power supplies are good. On the main board, LED DS2001 illuminates to indicate the +3.3 V Isolated power supply is operating, and LED DS2002 illuminates to indicate the +5 V Isolated power supply is operating.

Power Supplies on Main Board			
+3.3 V ER*	+15 V Isolated	+9 V Isolated	+3.3 V Isolated*** DS2001
+5 ER	-15 V Isolated	-9 V Isolated	+5 V Isolated**, *** DS2002

\* This supply is active whenever AC power is applied to the instrument.

\*\* This supply also provides power to the Mezzanine Board power supplies.

\*\*\* This supply has a "power-good" indicator LED as indicated in the picture below.

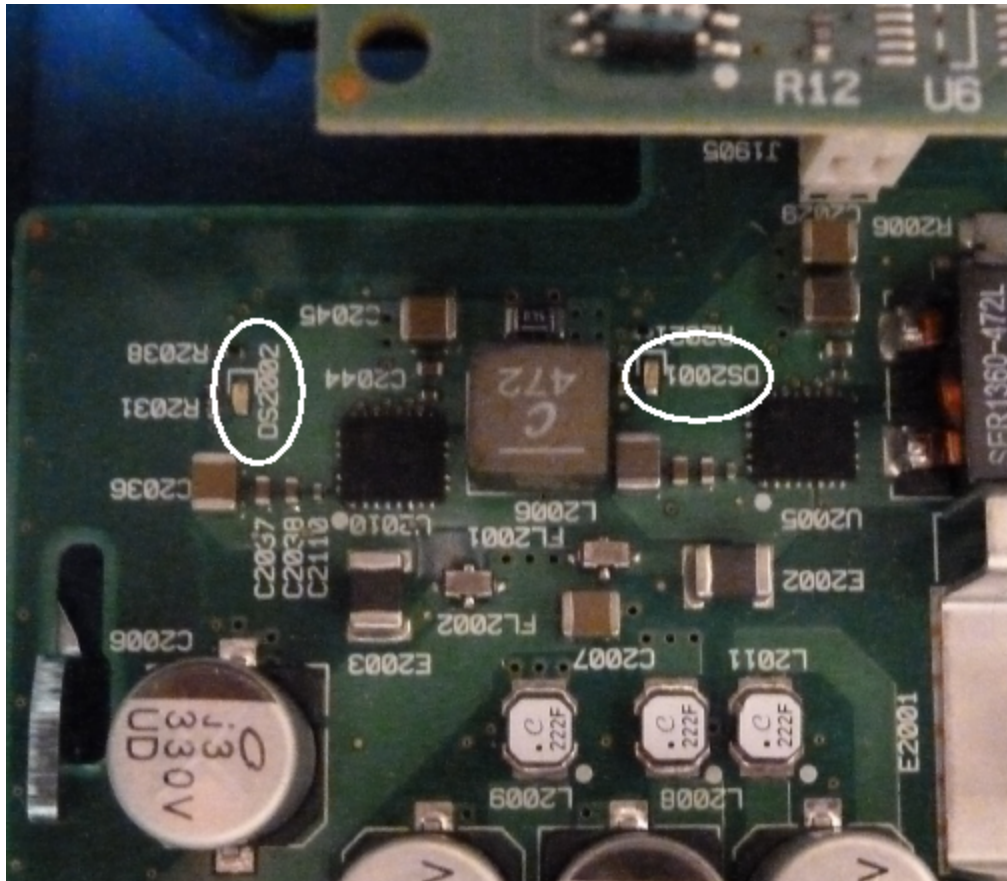



## Mezzanine Board Power Supplies

Power Supplies on Mezzanine Board			
+1.1 V*** DS1501	+1.5 V*** DS1501	+1.8 V*** DS1501	+2.5 V*** DS1501

\*\*\* This supply has a "power-good" indicator LED as indicated in the picture below.



## Self-Test Errors 607 through 611

Self-test errors 607-611 indicate that the processor board is unable to correctly program or communicate with the waveform FPGA (U301) on the mezzanine board. In this case, further troubleshooting is required. The problem could be due to out of date firmware, or a failing or unseated processor board or main board. Before troubleshooting these errors, ensure that the instrument firmware is up to date. If the errors are still reported, continue with the following procedure.

### Reseat the Boards

Power off the unit and remove the cover. Reseat the mezzanine board and the main board. Power up the unit and see whether errors 607 through 611 are still reported. Check all power good LEDs to see if the power supplies are operating. Not all power supplies have an LED.

### Check SPI Communications

If you still see self-test errors after reseating the boards, the next step is to probe the SPI communications lines between the processor board and the main board. First, locate LED DS1501 on the mezzanine board as shown above. Cycle power on the unit, wait until it fully boots, and see whether the main board "power good" LEDs (DS2001, DS2002) illuminate. Check whether the mezzanine board "power good" LED DS1501 illuminates, indicating the mezzanine board power supplies are good.

### Check FPGA programming success

The DS401 LED on the mezzanine board (to the left of DS1501 in the picture above) indicates whether the FPGA was successfully programmed. If illuminated, it indicates that the FPGA is programmed and running. If it fails to light and all power supplies are good, most likely there is a SPI communications failure from the processor board to the main board or from the main board to the mezzanine board.

### Check SPI Communications

Probe the front panel to main board connector J201 pins 23, 24, 26 and 27 to check for activity during bootup between the main board and the front panel board. Activity should be +3.3 V pulses (isolated). Note that activity ceases or becomes infrequent once the instrument is booted. If there is no activity, the fault most likely lies in the front panel board.

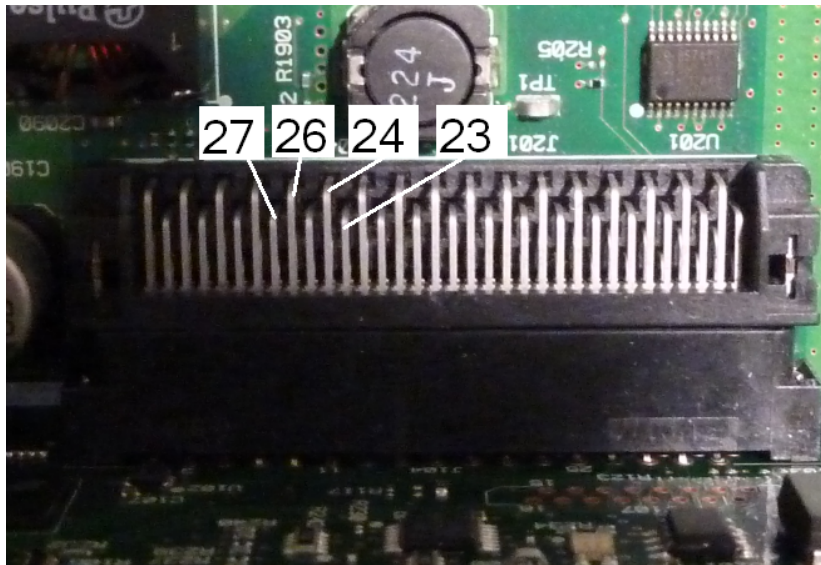

## Service and Repair - Introduction

Probe the Opto isolator U602 pin 6 on the main board with an oscilloscope, and cycle power on the unit (wait for full boot) to see if there is activity on the line. This line is used to reset the FPGA to initiate programming. Activity should be +3.3 V pulses (isolated).

Also check U601 (on the main board) pins 11, 12, 13, and 14 for activity during bootup. Note that activity ceases or becomes infrequent once the instrument is booted.

If there is no activity, the fault most likely lies in the main board.

If there is activity and the DS401 LED does not light, the fault most likely lies in the mezzanine board.

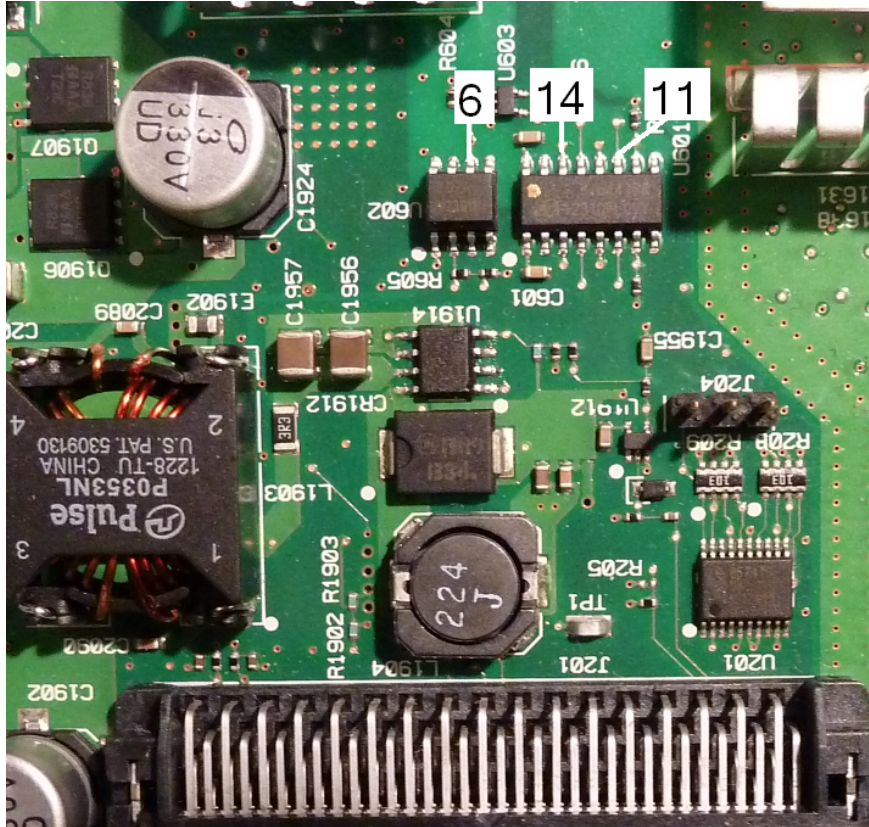

### 10 MHz Out

If the power supplies are functional and self-test passes, check the 10 MHz output at the rear panel. This output is present whenever the instrument has powered on and the processor and main board are operational. If the 10 MHz is present, but the display is not working, suspect the front panel board or display assembly.

## Self-Test Procedures

### Power-On Self-Test

Each time the instrument is powered on, self-tests are performed to check that the minimum set of logic and subsystems are functioning properly.

## Full Self-Test

Passing self-test provides a high degree of confidence that instrument is operating normally. Self-test procedure systematically exercises internal oscillator, digital infrastructure, waveform memory, and analog attenuator paths. It attempts to isolate failures to a particular assembly to facilitate service. During the test, instrument main output(s) are disconnected internally from the BNC connectors and are connected to the internal ADC, which checks for expected signal levels throughout the instrument.

A complete self-test (**\*TST?**) takes approximately 15 seconds. You may hear relays switching during the procedure. When self-test completes, either "Self-test Passed" or "Self-test Failed" appears on the front panel. Self-test error messages are described in detail below.

Execute self-test before any verifications or adjustments.

### To Run Self-Test

Remove all input connections to instrument before self-test. Cycle power to run power-on self-test.

#### Remote I/O Execution

1. Connect to instrument using remote interface ([LAN Configuration Procedure](#)).
2. Send **\*TST?** and read the result: Pass (+0) or fail (+1). Use **SYSTem:ERRor?** to view errors.

#### Front Panel Execution

1. Press **[System] > Instr Setup > Self Test**.
2. A progress bar will appear as self-test executes. After completion, view any failures by pressing **[System] > Help** and then choosing the topic **View remote command error queue**.

### Self-Test Error Numbers and Messages (33500 Series)

A failure can generate multiple error messages; the first one should be considered the primary cause of failure. Some error messages include a failing channel number (1 or 2), shown as n in the messages below.

Error	Message and Meaning (33500 Series)	Probable Cause (33500 Series)
601	<p>Self-test failed; <b>real time clock settings lost</b></p> <p>Real time clock's date-time settings were lost, likely due a disconnected or discharged RTC battery (coin cell found on the front panel board). Error can also occur if processor board is removed and reinserted into front panel assembly. This error condition is captured at power-on, and will be reported by self-test until the problem is corrected and power is cycled.</p>	RTC Battery

Error	Message and Meaning (33500 Series)	Probable Cause (33500 Series)
602	<p><b>Self-test failed; main CPU power supply out of range</b></p> <p>Processor board detected that one of its supplies was more than 10% out of the nominal voltage range.</p>	Processor Board
603	<p><b>Self-test failed; main CPU error accessing boot env</b></p> <p>Processor wasn't able to access its boot parameters from flash, possibly due to out of date firmware, or a problem on the processor board.</p>	Processor Board
604	<p><b>Self-test failed; front panel processor ping failed</b></p> <p>Processor board tried to read front panel revision code and received a 0, possibly due to un-programmed front panel processor, unseated processor board, or defective front panel processor.</p>	Front Panel Board
605	<p><b>Self-test failed; waveform FPGA not programmed</b></p> <p>Processor could not program the waveform FPGA (U1005) at boot-up. The hardware will not work properly.</p>	Processor Board or Main Board. See <a href="#">Troubleshooting</a> for additional information on troubleshooting errors 605-609.
606	<p><b>Self-test failed; waveform FPGA revision check failed</b></p> <p>Processor tried to read the revision register from the waveform FPGA (U1005) and received an invalid value, possibly due to un-programmed FPGA or internal SPI communications failure.</p>	
607	<p>Self-test failed; <b>waveform FPGA read back error</b></p> <p>Processor was unable to write and read back from a test location in the waveform FPGA (U1005), possibly due to un-programmed FPGA or internal SPI communications failure.</p>	
608	<p><b>Self-test failed; waveform FPGA security check failed</b></p> <p>Waveform FPGA (U1005) failed internal security check, possibly due to FPGA failures (tests 605-608), invalid FPGA image, or malfunctioning security device (U1007).Self-test exits on this failure.</p>	
609	<p><b>Self-test failed; waveform FPGA security check failed</b></p> <p>Waveform FPGA (U1005) failed internal security check, possibly due to FPGA failures (tests 605-608), invalid FPGA image, or malfunctioning security device (U1007).Self-test exits on this failure.</p>	Main Board
610	<p><b>Self-test failed; main PLL not locked</b></p> <p>Waveform FPGA (U1005) unable to lock to internal 10MHz oscillator (U903 or U905).</p>	Main Board
611	<p>Self-test failed; <b>FPGA PLL not locked</b></p> <p>Waveform FPGA (U1005) unable to lock to internal sample clock generator IC (U906).</p>	Main Board

Error	Message and Meaning (33500 Series)	Probable Cause (33500 Series)
612	<p><b>Self-test failed; Chan n, waveform memory PLL not locked</b></p> <p>Waveform RAM for indicated channel (U1101 or U1102) was unable to lock to its clock.</p>	Main Board
613	<p><b>Self-test failed; Chan n, waveform memory not initialized</b></p> <p>Waveform RAM for indicated channel (U1101 or U1102) failed to initialize.</p>	Main Board
615	<p><b>Self-test failed; modulation ADC offset too low (too high)</b></p> <p>Internal ADC's measurement of ACOM out of limits.</p>	Main Board
616	<p>Self-test failed; <b>modulation ADC reference too low (too high)</b></p> <p>Internal ADC's measurement of its voltage reference (VRef) was out of limits.</p>	Main Board
620	<p>Self-test failed; <b>Chan n, waveform memory test failed on idle</b></p> <p>Waveform memory test not started properly, probably due to error in waveform FPGA (U1005)</p>	Main Board
621	<p><b>Self-test failed; Chan n, waveform memory test failed</b></p> <p>Waveform RAM memory test for the indicated channel (U1101 or U1102) failed; test consists of writing and reading back the entire waveform RAM with a predetermined pattern.</p>	Main Board
625	<p><b>Self-test failed; Chan n, waveform DAC gain[idx] too low (too high)</b></p> <p>Waveform DAC (U1801 or U1501) not providing correct output. Gain [idx] of 1 references POS voltage test; gain [idx] of 2 references NEG voltage test.</p>	Main Board
630	<p><b>Self-test failed; Chan n, sub attenuator failure 0dB</b></p> <p>Trim DAC inside waveform DAC (U1801 or U1501) not providing correct output at 0 dB. If this fails, test 631 will not be executed.</p>	Main Board
631	<p><b>Self-test failed; Chan n, sub attenuator &lt;-7.00 to 0.00&gt;dB too low (too high)</b></p> <p>Trim DAC inside waveform DAC (U1801 or U1501) producing output outside expected range.</p>	Main Board
635	<p>Self-test failed; <b>Chan n, null DAC gain[idx] too low (too high)</b></p> <p>Aux DAC output of waveform DAC (U1801 or U1501) or its associated analog circuitry producing output outside expected range. Gain [idx] of 1 references POS voltage test; gain [idx] of 2 references NEG voltage test.</p>	Main Board

Error	Message and Meaning (33500 Series)	Probable Cause (33500 Series)
640	<p><b>Self-test failed; Chan n, offset DAC gain[idx] too low (too high)</b></p> <p>Offset DAC (U1702 or U2002) or its associated circuitry producing output outside expected range. For offset DAC, [idx] polarities are inverted: gain [idx] of 1 references NEG voltage test; gain [idx] of 2 references POS voltage test.</p>	Main Board
650	<p>Self-test failed; <b>Chan n, 0dB path failure expected 0dB, measured value dB</b></p> <p>Straight-through path (no attenuator) from waveform DAC to ADC input producing output outside expected range. If this fails, extended attenuator test 655 is not executed.</p>	Main Board
655	<p>Self-test failed; <b>Chan n, -8 dB pre attenuator path too low (too high)</b></p> <p>Self-test failed; <b>Chan n, -16 dB pre attenuator path too low (too high)</b></p> <p>Self-test failed; <b>Chan n, -24 dB pre attenuator path too low (too high)</b></p> <p>Self-test failed; <b>Chan n, -24 dB post attenuator path too low (too high)</b></p> <p>Specified attenuator relay malfunctioning, or associated circuitry not providing expected attenuation.</p>	Main Board

### Self-Test Error Numbers and Messages (33600 Series)

A failure can generate multiple error messages; the first one should be considered the primary cause of failure. Some error messages include a failing channel number (1 or 2), shown as n in the messages below.

Error	Message and Meaning (33600 Series)	Probable Cause (33600 Series)
601	<p>Self-test failed; <b>real time clock settings lost</b></p> <p>Real time clock's date-time settings were lost, likely due a disconnected or discharged RTC battery (coin cell found on the front panel board). Error can also occur if processor board is removed and reinserted into front panel assembly. This error condition is captured at power-on, and will be reported by self-test until the problem is corrected and power is cycled.</p>	RTC Battery
602	<p><b>Self-test failed; keyboard processor not responding</b></p> <p>A front panel microprocessor is not functional.</p>	Front Panel Board
603	<p><b>Self-test failed; incorrect keyboard processor product ID</b></p> <p>A front panel microprocessor is faulty.</p>	Front Panel Board

Error	Message and Meaning (33600 Series)	Probable Cause (33600 Series)
604	<p><b>Self-test failed; FPGA temperature out of limits</b></p> <p>Temperature sensor on the FPGA (U301 on the mezzanine board) indicates excessive temperature.</p>	Mezzanine Board or Fan
604	<p><b>Self-test failed; unknown CPU exception during temperature test</b></p> <p>Attempt to communicate with temperature sensor on the FPGA (U301 on the mezzanine board) failed.</p>	Front Panel Board
605	<p><b>Self-test failed; front panel I2C communication to main board temp sensor failed</b></p> <p>A front panel communications with a temperature sensor on the main board is not operating.</p>	Main Board
605	<p><b>Self-test failed; main board temperature out of limits</b></p> <p>A temperature sensor on the main board indicates excessive temperature.</p>	Main Board or Fan
606	<p><b>Self-test failed; front panel processor ping failed</b></p> <p>Processor board tried to read front panel revision code and received a 0, possibly due to an unprogrammed or defective front panel processor.</p>	Front Panel Board
607	<p>Self-test failed; <b>waveform FPGA not programmed</b></p> <p>Processor could not program the waveform FPGA (U301 on mezzanine board) at boot-up. The hardware will not work properly.</p>	<p>Front panel board, Main board, or Mezzanine board. See <b>Troubleshooting 33600 Series</b> for additional information on troubleshooting errors 607 to 611.</p>
608	<p><b>Self-test failed; waveform FPGA revision check failed</b></p> <p>Processor tried to read the revision register from the waveform FPGA (U301 on mezzanine board) and received an invalid value, possibly due to an unprogrammed FPGA or an internal SPI communications failure.</p>	
609	<p><b>Self-test failed; waveform FPGA read back error</b></p> <p>Processor was unable to write and read back from a test location in the waveform FPGA (U301 on mezzanine board), possibly due to an unprogrammed FPGA or internal SPI communications failure.</p>	
610	<p><b>Self-test failed; waveform FPGA error</b></p> <p>Processor was unable to write and read back from the FPGA due to hardware failure in the waveform FPGA (U301 on mezzanine board), or possibly due to an unprogrammed FPGA or internal SPI communications failure.</p>	



Error	Message and Meaning (33600 Series)	Probable Cause (33600 Series)
611	Self-test failed; <b>waveform FPGA authentication failed</b> Processor was unable to verify that the FPGA programmed correctly and verify the security check.	Mezzanine Board. See <a href="#">Troubleshooting 33600 Series</a> for additional information on troubleshooting errors 607 to 611.
612	<b>Self-test failed; main PLL not locked</b> Phase Locked Loop circuit on the Mezzanine board was unable to lock to the internal 10 MHz reference oscillator.	Mezzanine Board
613	<b>Self-test failed; FPGA not locked to 250MHz</b> Phase Locked Loop circuit on the Mezzanine board was unable to lock at 250 MHz.	Mezzanine Board
614	<b>Self-test failed; waveform memory PLL not locked</b> Phase Locked Loop circuit on the Mezzanine board was unable to lock at waveform memory frequency.	Mezzanine Board
615	<b>Self-test failed; waveform memory not initialized</b> The waveform memory did not correctly initialize.	
616	<b>Self-test failed; modulation ADC offset too low</b> The external modulation ADC circuit has failed to properly measure a ground reference voltage.	Main Board
616	<b>Self-test failed; modulation ADC offset too high</b> The external modulation ADC circuit has failed to properly measure a ground reference voltage.	Main Board
617	<b>Self-test failed; modulation ADC reference too low</b> The external modulation ADC circuit has failed to measure a reference voltage properly.	Main Board
617	<b>Self-test failed; modulation ADC reference too high</b> The external modulation ADC circuit has failed to measure a reference voltage properly.	Main Board
620	Self-test failed; <b>Chan n, waveform memory test failed on idle</b> Waveform memory test not started properly, probably due to error in waveform FPGA (U301).	Mezzanine Board
621	<b>Self-test failed; Chan n, waveform memory test failed</b> Waveform RAM memory test for the indicated channel (U601 and U602 or U701 and U702) failed; test consists of writing and reading back the entire waveform RAM with a predetermined pattern.	Mezzanine Board

Error	Message and Meaning (33600 Series)	Probable Cause (33600 Series)
625	<p><b>Self-test failed; Chan n, waveform DAC gain[idx] too low (too high)</b></p> <p>Waveform DAC (U1001 or U1101 on mezzanine board) not providing correct output. Gain [idx] of 1 references Positive voltage test; gain [idx] of 2 references Negative voltage test. Also tests U901 and U902 for Channel 1 or U1401 and U1402 (for channel 2) on the main board.</p>	Mezzanine Board or Main Board
626	<p><b>Self-test failed; CH1 waveform DAC is not synchronized properly</b></p> <p>The Waveform DAC (U1001) on Channel 1 cannot frequency lock to the clocking signals.</p>	Mezzanine Board
626	<p><b>Self-test failed; CH2 waveform DAC is not synchronized properly</b></p> <p>The Waveform DAC (U1101) on Channel 2 cannot frequency lock to the clocking signals.</p>	Mezzanine Board
626	<p><b>Self-test failed; Sync waveform DAC is not synchronized properly</b></p> <p>The Waveform DAC (U1201) on the Sync Channel cannot frequency lock to the clocking signals.</p>	Mezzanine Board
630	<p><b>Self-test failed; Chan n, sub attenuator failure 0dB</b></p> <p>Trim DAC inside waveform DAC (U1001 – Ch1 or U1101 – Ch2) not providing correct output at 0 dB. This test also depends upon the signal attenuation circuit on the main board (for Channel 1 this means U1401, U1402, relay attenuators K1501 - K1503, K1701 - K1704 and the amplifier circuit). If this fails, test 631 will not be executed.</p>	Mezzanine Board (DAC) or Main Board (signal attenuator chain).
631	<p><b>Self-test failed; Chan n, sub attenuator xx dB</b></p> <p>Trim DAC inside waveform DAC (U1001 or U1101) producing output outside expected range.</p>	Mezzanine Board
635	<p><b>Self-test failed; Chan n, null DAC gain xx</b></p> <p>A DC Nulling circuit (U1404, U1405), has failed to produce the expected voltage change.</p>	Main Board
640	<p><b>Self-test failed; Chan n, offset DAC gain xx</b></p> <p>A DC Offset signal generation circuit (U1609, U1610) has failed to produce the expected voltage change.</p>	Main Board

Error	Message and Meaning (33600 Series)	Probable Cause (33600 Series)
650	<p><b>Self-test failed; 0dB path failure channel n expected 0dB, measured yy dB</b></p> <p>The straight-through path (no attenuator) from waveform DAC to ADC input producing output outside expected range. Waveform DAC (U1001 – Ch1 or U1101 – Ch2) not providing correct output at 0 dB. This test also depends upon the signal attenuation circuit on the main board (for Channel 1 this means U1401, U1402, relay attenuators K1501 - K1503, K1701 - K1704 and the amplifier circuit).</p> <p>If this fails, extended attenuator test 655 is not executed.</p>	Mezzanine Board Waveform DAC or Main Board
655	<p><b>Self-test failed; Chan n, -8 dB pre attenuator path too low (too high)</b>  <b>Self-test failed; Chan n, -16 dB pre attenuator path too low (too high)</b>  <b>Self-test failed; Chan n, -24 dB pre attenuator path too low (too high)</b>  <b>Self-test failed; Chan n, -24 dB post attenuator path too low (too high)</b></p> <p>Specified attenuator relay malfunctioning, or associated circuitry not providing expected attenuation.</p>	Main Board
660	<p><b>Self-test failed; Channel n: xx dB pre/post attenuator relay inoperative</b></p> <p>Self-test is unable to change the signal amplitude with the relay attenuators named.</p>	Main Board
661	<p><b>Self-test failed; EEPROM access failed</b></p> <p>Main CPU is unable to read a memory chip (U2) on the front panel board.</p>	Main Board

## Replaceable Parts

**CAUTION**

Always use anti-static techniques when assemblies are handled or serviced.

The following table lists the replacement assemblies for the instrument:

Part Number	Description
5041-5288	Bumper Kit
5041-5285	Handle
5041-5641	Cover (33500B Series)
33200-84111	Cover (33600A Series)
3100-3759	Encoder
53200-87435	Knob

Part Number	Description
33521-88011	Keypad for one-channel models
33522-88011	Keypad for two-channel models
2090-1138	Display
1250-3569	Front Panel BNCs
33500-60211	Front Panel for 33500B Series one-channel models
33500-60212	Front Panel for 33500B Series two-channel models
33600-60211	Front Panel for 33600A Series one-channel models
33600-60212	Front Panel for 33600A Series two-channel models
33500-66528	Front Panel Board (33500B Series)
1252-8483	USB Connector
1254-0795	LAN Connector
33500-61628	Line Filter Assembly (33500B Series)
5190-9114	Line Filter Assembly (33600A Series)
33250-68501	Fan (33500B Series)
5041-5244	Fan Kit (33600A Series)
1420-0356	Battery (in Front Panel) CR2032 for 33600A Series
1420-0952	Battery (in Front Panel) CR2032 for 33500B Series
53200-80012	Power Supply Kit with battery main cable* (33500B Series)
5190-9092	Power Supply Cover (33600A Series)
0950-6383	Power Supply* (33600A Series)

\* The 33500B Series models contain a 15 A, 250 V radial lead fuse. Fuse replacement is not recommended.

\* The 33600A Series models contain two 3.15 A, 250 V radial lead fuses. Fuse replacement is not recommended.

## Disassembly - 33500 Series

This section describes the procedure for disassembling the instrument.

### Tools Required

The following tools are required for instrument disassembly.

## Service and Repair - Introduction

- T15 Torx driver (most disassembly)
- T8 Torx driver (front panel disassembly)
- Posidrive and flat bladed screw drivers
- 14 mm nut driver, hollow shaft (rear-panel BNC connectors)
- 7 mm nut driver (rear-panel GPIB connector)

### **WARNING**

Only qualified, service-trained personnel who are aware of the hazards involved should remove instrument covers. Always disconnect the power cable and any external circuits before removing the instrument cover. Some circuits are active and have power applied even when the power switch is turned off.

Always disconnect all inputs, cords, and cables before disassembling the instrument.

## General Disassembly Procedure

1. Turn off the power. Remove all cables from the instrument.
2. Rotate the handle upright and pull off.



3. Pull off the instrument bumpers.



4. Loosen the two captive screws (circled in red, below) in the rear bezel and remove the rear bezel.



5. Slide off the instrument cover.

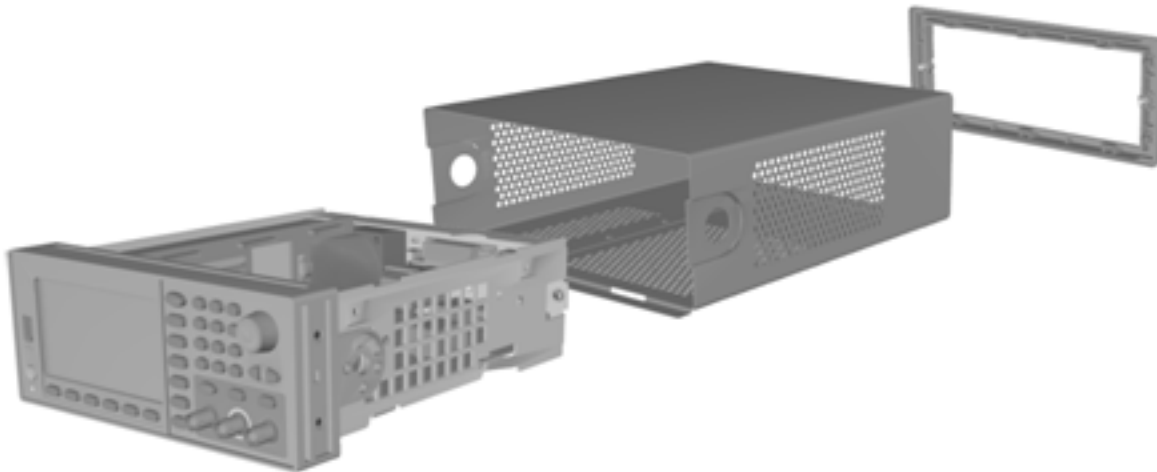

Many of the service procedures can now be performed without further disassembly. Troubleshooting and service procedures that require power be applied can be performed with the instrument in this state of disassembly.

**WARNING**

*SHOCK HAZARD. Only service-trained personnel who are aware of the hazards involved should remove the instrument covers. Dangerous voltages may be encountered with the instrument covers removed.*

## Main Component Disassembly

1. Remove processor board. Turn instrument over. Remove the T-8 screw securing the processor board. Press the tabs on the processor board connector and slide processor board toward the back of instrument to disengage the connector. Lift processor board out.

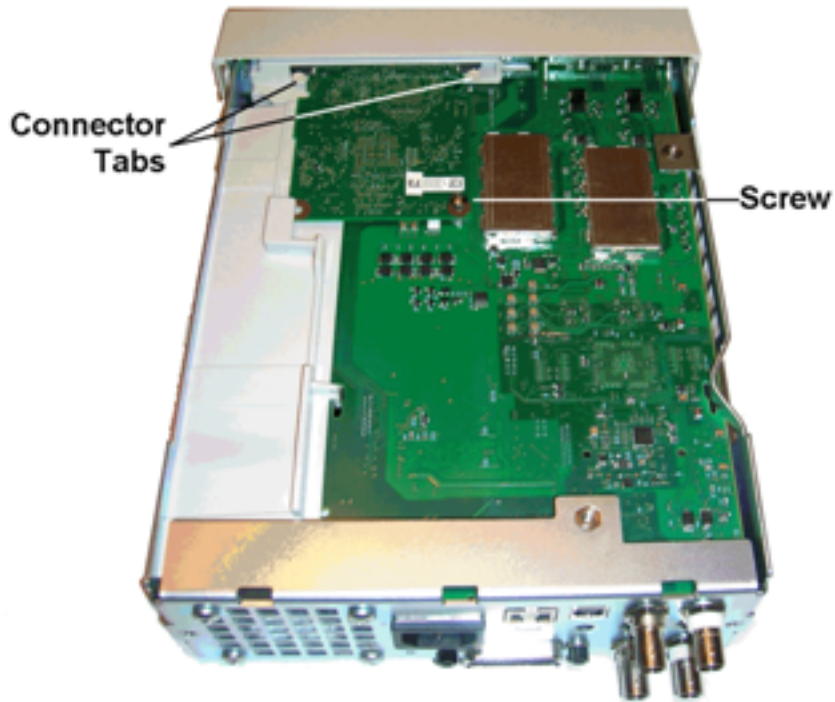

2. Remove front panel assembly. Remove T15 screw holding the main board. Press latch on left side of front panel and latch in power supply cover on right side of front panel. Push sides of metal chassis toward center to disengage studs on sides of front panel assembly. Gently pull front panel assembly straight off chassis. Note that front panel assembly has an electrical connector to the main board. Be careful not to damaged connector.

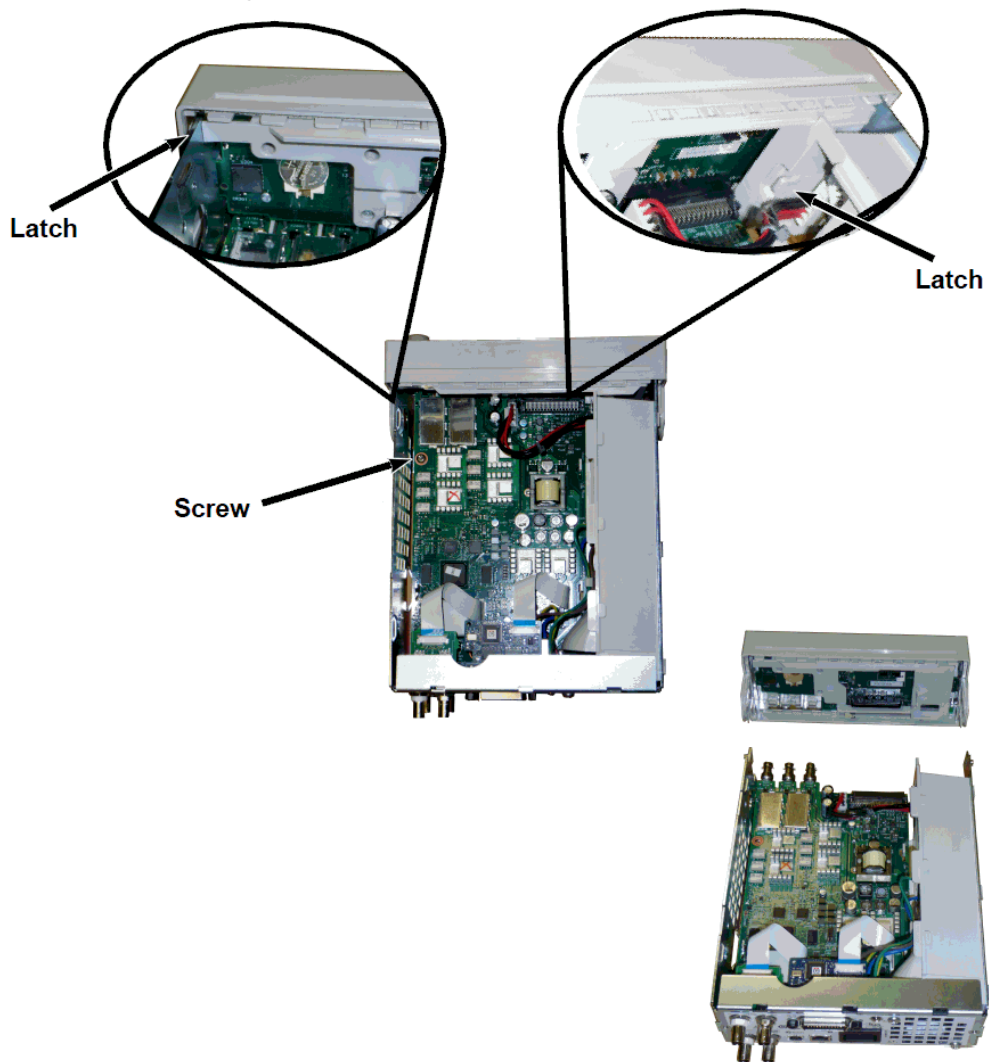



3. Remove Main Board. Disconnect power supply connector from main board. Disconnect **GPIB** and **Oscillator In** ribbon cables. Disconnect fan power cable from main board. Loosen and remove nuts securing **Modulation In** and **Ext Trig** BNC connector to rear panel. Remove screw below GPIB board securing main board to chassis. Slide main board toward front of instrument to disengage tabs on power supply cover. Lift main board out.

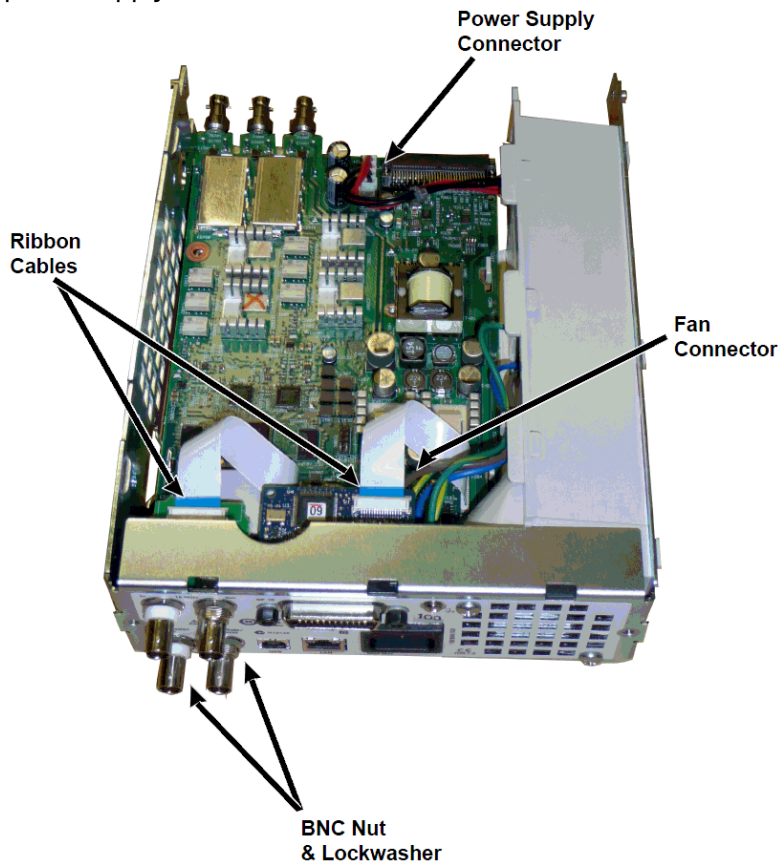

4. Remove Power Supply. Disconnect input power to power supply board (blue and brown wires). Disconnect green ground connector on power supply board. Remove screw securing power supply cover to chassis. Slide power supply assembly toward front of instrument and remove.

**WARNING**

Always re-attach the green ground wire to the power supply before operating the instrument.

5. The remaining assemblies can be removed from the chassis if needed.

## Front Panel Disassembly

1. Pull the knob straight off. Remove six T8 screws securing front panel bracket to front panel assembly. Lift out bracket.

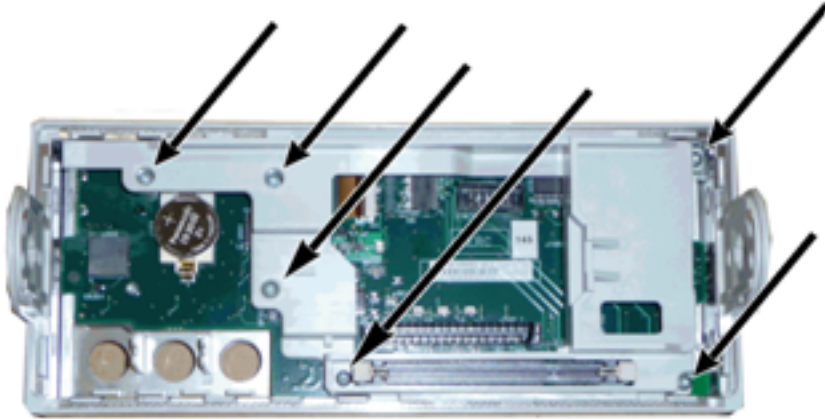

## Service and Repair - Introduction

2. Disconnect display ribbon cable from the front panel board. Remove T8 screws securing the front panel board to the front panel assembly. Lift out printed circuit board.

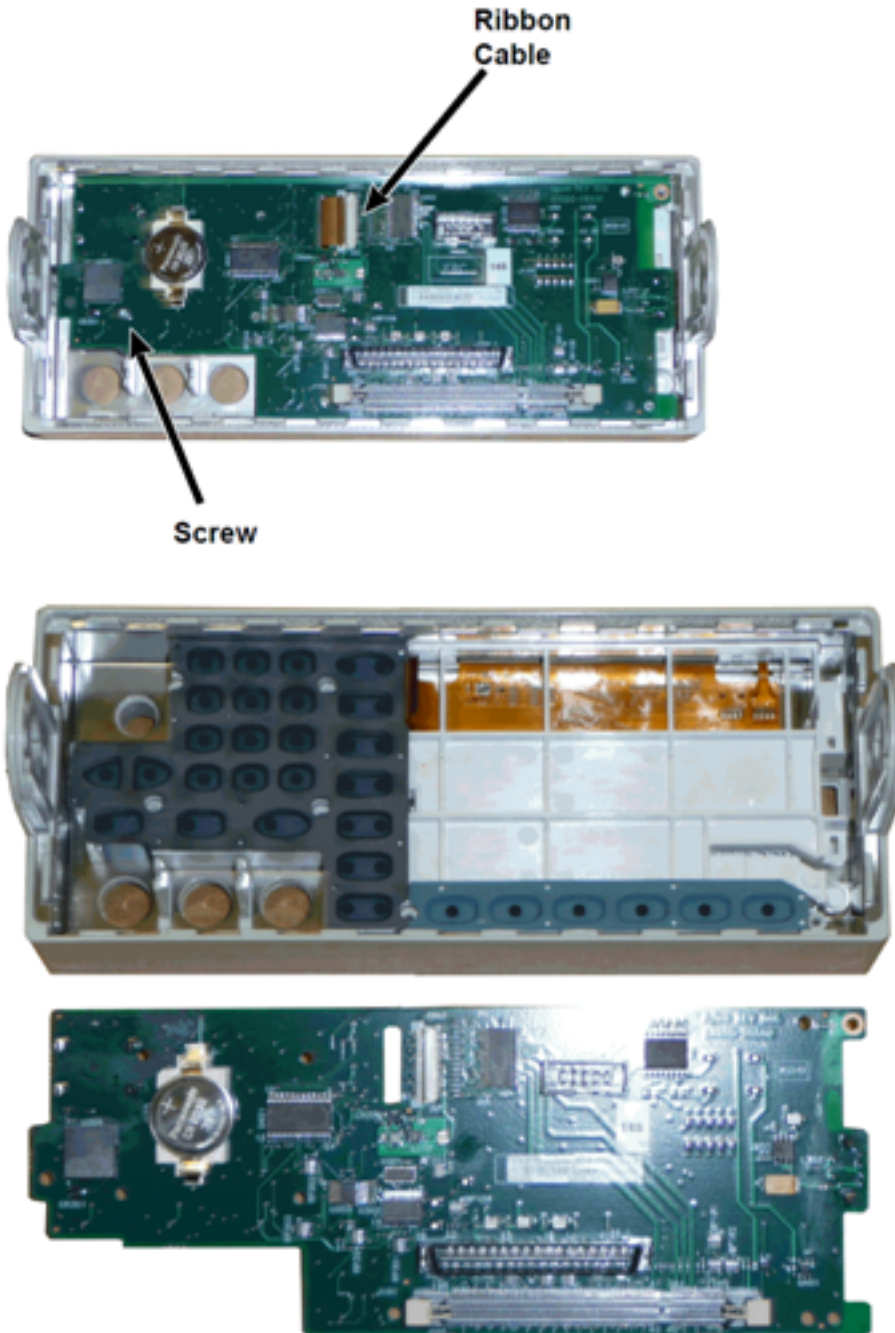

3. All additional front panel assemblies can now be lifted out of front panel housing.

## Disassembly - 33600 Series

This section describes the procedure for disassembling the instrument.

## Tools Required

The following tools are required for instrument disassembly.

- T15 Torx driver (most disassembly)
- T8 Torx driver (front panel disassembly)
- Posidrive and flat bladed screw drivers
- 14 mm nut driver, hollow shaft (rear-panel BNC connectors)
- T10 Torx driver (rear-panel GPIB connector)

**WARNING**

Only qualified, service-trained personnel who are aware of the hazards involved should remove instrument covers. Always disconnect the power cable and any external circuits before removing the instrument cover. Some circuits are active and have power applied even when the power switch is turned off.

Always disconnect all inputs, cords, and cables before disassembling the instrument.

## General Disassembly Procedure

1. Turn off the power. Remove all cables from the instrument.
2. Rotate the handle upright and pull off.



## Service and Repair - Introduction

3. Pull off the instrument bumpers.



4. Loosen the two captive screws (circled in red, below) in the rear bezel and remove the rear bezel.



5. Slide off the instrument cover.

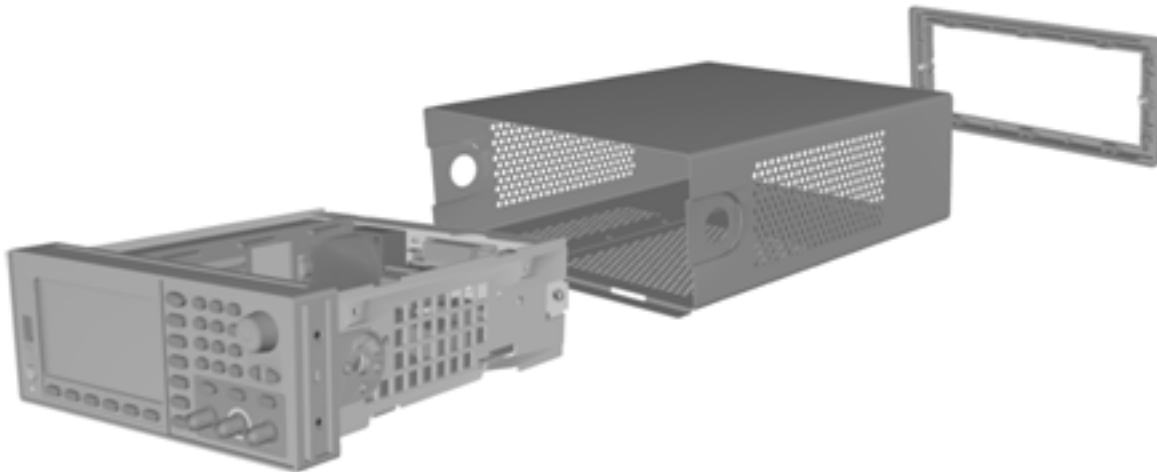

Many of the service procedures can now be performed without further disassembly. Troubleshooting and service procedures that require power be applied can be performed with the instrument in this state of disassembly.

### **WARNING**

*SHOCK HAZARD. Only service-trained personnel who are aware of the hazards involved should remove the instrument covers. Dangerous voltages may be encountered with the instrument covers removed.*

## Main Component Disassembly

### To remove the front panel and front panel PCBA

1. Remove the two screws near the front of the power supply deck that secure the power supply deck in place.

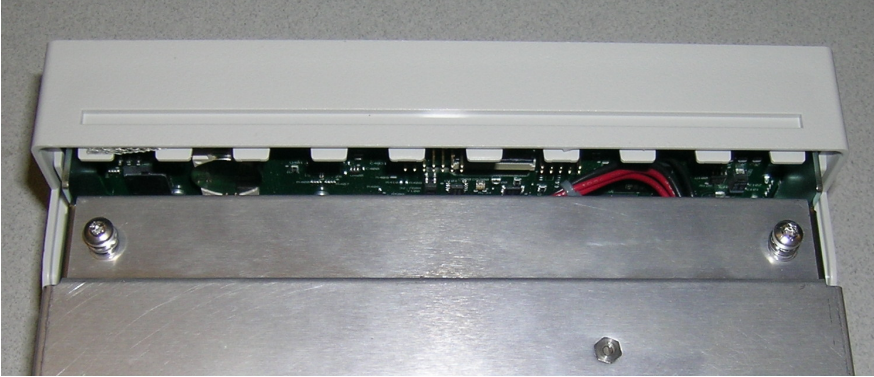

2. Tilt the power supply deck upward and lift it over the edge of the chassis. Then place it upside down on your bench, as shown below.

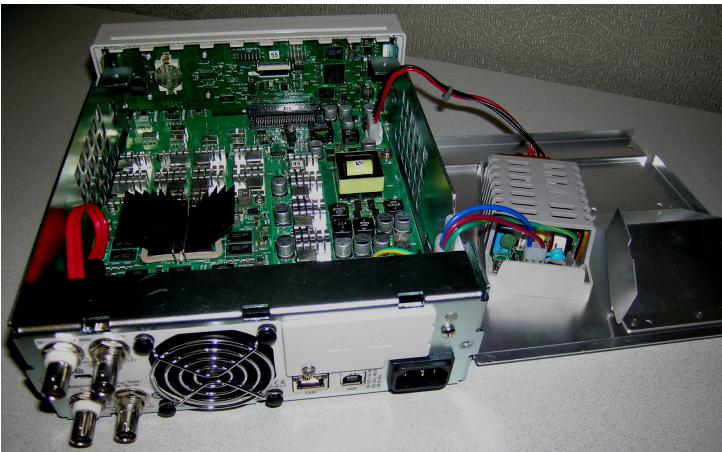

3. Remove the two screws from the main board. These are located directly below the two screws that you removed in step 1.
4. Push the sides of the chassis inward and slide the front panel forward to pull the front panel off.
5. Disconnect the cable that connects the front panel board to the display by lifting up on the connector lever to release the cable.
6. Remove the seven screws that hold the PCBA to the front panel plastic.

### To remove the main board

1. If you have the GPIB option installed, remove it as described [here](#).
2. Remove the front panel as described above.

## Service and Repair - Introduction

3. To access the main board, lift the power supply deck up and away from the instrument. You may either rest it in the groove on the instrument's chassis or move it completely out of the way and set it on your bench, as shown below.

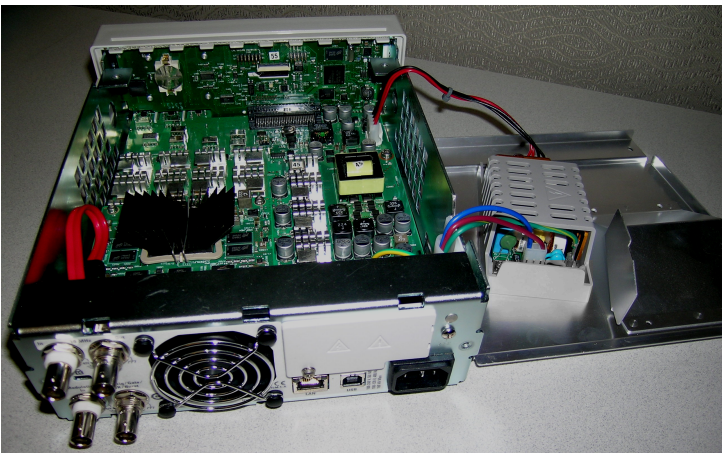

4. Remove the cable with the red and black wires from the connector at the front of the main board.
5. Remove the other cables (from the AC power inlet module) from the rear of the power supply.
6. Disconnect the red cable and the fan cable from the rear of the main board.
7. Remove the screw that connects the main board to the chassis at the rear of the instrument.
8. Remove the lock washers and nuts from the lower two BNC connectors on the rear panel.
9. Slide the main board slightly to clear the chassis side hooks and then pull up and out to remove the board.

## Battery Replacement

This section describes the procedure for replacing the battery on the instrument's front panel.

**WARNING**

Only qualified, service-trained personnel who are aware of the hazards involved should remove instrument covers. Always disconnect the power cable and any external circuits before removing the instrument cover. Some circuits are active and have power applied even when the power switch is turned off.

Always disconnect all inputs, cords, and cables before disassembling the instrument.

## Tools Required

- T20 Torx driver (most disassembly)
- Small, flat-blade screw driver (for prying)



## Procedure

(Images shown below provided courtesy of Keystone Electronics Corp.)

1. Turn off the power and remove all measurement leads and other cables, including the power cord, from the instrument before continuing.
2. Follow the [33500 Series disassembly procedure](#) or [33600 Series disassembly procedure](#) to disassemble the instrument.
3. Locate the battery on the front panel, and position the screwdriver tip under the battery, as shown.

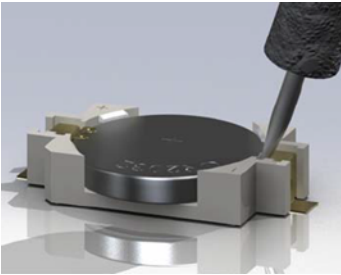

4. Use the screwdriver to pry the battery from the battery holder.

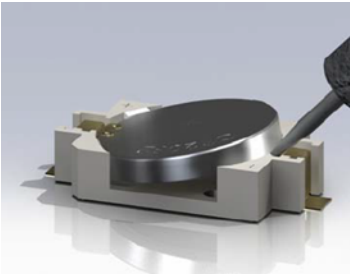

5. Remove the battery and discard or recycle it in accordance with all applicable regulations.
6. Position the new battery in the battery holder, + side up. Push down gently to seat the battery in the holder.

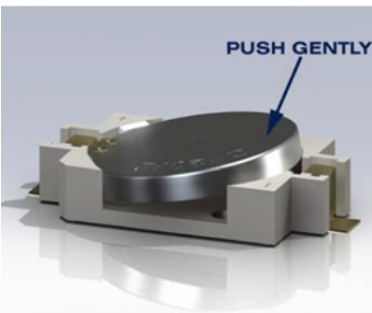

7. Re-assemble the instrument completely before connecting any cables or cords.

This concludes the battery replacement procedure.

## Installing the Optional GPIB Interface

### WARNING

This procedure should be performed by qualified service personnel only. Turn off the power and remove all measurement leads and other cables, including the power cord, from the instrument before continuing.

### Tools Required

This procedure requires a T10 Torx driver.

### Installation Procedure

1. Turn off the power and remove all measurement leads and other cables, including the power cord, from the instrument before continuing.
2. Use the Torx driver to remove the screw from the GPIB cover plate. Retain the screw for use later in this procedure. Then remove the cover plate by sliding it to the left.

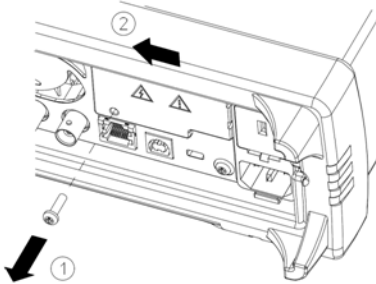

### WARNING

#### Retain GPIB Cover Plate

After installing the GPIB option, retain the cover plate for use in the event that you ever remove the GPIB option. The instrument should never be connected to power or inputs on the measurement terminals without either the GPIB module or the cover plate securely covering the rear-panel opening.

3. Locate the connector, just inside the unit, for the cable attached to the GPIB module

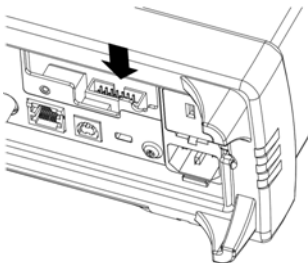

## Service and Repair - Introduction

4. Bend the cable so that it extends above the circuit board. Attach the cable to the connector that was located in the previous step.

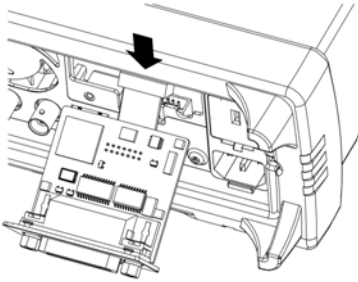

5. Put the module into the unit and slide the GPIB board to the right so that it is flush against the instrument's sheet metal. Use the screw that was removed above to secure the GPIB plate in place.

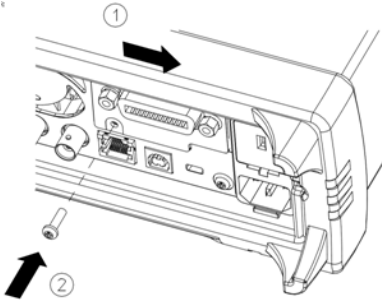

This concludes the GPIB installation procedure.

# Index

---

-

-24 dB range 486, 495, 502, 538, 549

-8 dB range 484, 497, 521, 525, 540, 542, 553

\*

\*CLS 306

\*ESE 307

\*ESR? 307

\*IDN? 308

\*OPC 309

\*OPC? 309

\*OPT? 309

\*PSC 310

\*PSC? 310

\*RCL 311

\*RST 312

\*SAV 311

\*SRE 312

\*STB? 313

\*TRG 313

\*TST? 314

\*WAI 314

1

1 Vpp range 517

---

## A

ABORt 214

aborting calibration 488, 530

AC Amplitude 482, 493, 499, 516, 535, 545

ADDReSS 390

adjustment 474, 484, 486, 488-491, 493, 495, 497-499, 502-503, 508, 517, 521, 525, 530-533, 535, 538, 540, 542, 544-545, 549, 551, 553

ADVance 283

ALL 242, 316-317, 331, 336, 393

AM 107, 215-218, 220, 233, 235, 265, 267, 276, 278, 355, 357, 362, 364

AM Subsystem 214

Amplitude 40

AMPLitude 381

amplitude modulation 107

ANGle 416

ANGLE 414

APPLy 222-230

APPLy Subsystem 221

ARB2 249

arbitrary 429

---

ARBitrary 223, 250, 282-285, 287-288, 300-303, 332, 349, 367, 416

arbitrary waveform 48, 74, 429

arbitrary waveform editor 74

ARBRate 259

ASCII String Parameters 209

ATTRibute 252-253

AUTO 368, 424

AVERAge 252

## B

BALance 300-302

BANDwidth 289

battery 591

battery replacement 591

BEEPer 388-389

block diagram 556, 558

Boolean Parameters 209

BORDer 268

BOTH 292, 296

BPSK 218, 220, 232-233, 235, 265, 267, 276, 278, 355, 357, 362, 364

BPSK Subsystem 231

BRATe 289

burst 60, 62

---

BURSt 239-241

BURSt Subsystem 236

burst waveform 60

BUS 209

## C

calibration 472, 474,  
477, 479, 481-482,  
484, 486, 488-490,  
493, 495, 497-499,  
502-503, 507-508,  
512-517, 521, 525,  
530-532, 535, 538,  
540, 542, 544-545,  
549, 551, 553

CALibration 242-245

calibration errors 505,  
555

CALibration  
Subsystem 242

Carrying Handle 37

CATalog 256, 325, 331-  
333, 392

CDIRectory 334

CENTER 270

CFACtor 252

channel 2  
adjustments 479,  
513

channel configuration 86

CLEAR 256

CLEAR 259, 261

Clear Status 455

CLICK 389

CLS 208, 306, 455

CODE 243

COMBine 246

command language

commands by  
subsystem 20,  
22, 212

quick reference 431

Command  
Separators 207

COMMunicate 390, 398-  
407

CONDition 375, 377

Configure a Pulse  
Waveform 47

configuring remote  
interface 71

Contacting  
Keysight 14

CONTinuous 316

CONTRol 398

COPY 334-335

COUNT 243, 394, 410

COUPLE 270-272, 365-  
367, 419

CURRent 369

CYCLE 323

## D

DAC 250

DATA 249-250, 252-254,  
256, 286, 290, 304,

332, 336-337, 339

DATA Subsystem 247

DATE 391

DC 224

DC Offset 42, 483, 516

DC Offset Voltage 42

DC Voltage 45

DCYcle 293, 299, 360

DEF Parameters 207

DELay 411

DELete 325, 335, 392-  
393

DEPTH 215

DESCription 393

DESired 321

DEViation 263, 353, 359-  
360

Device Clear 210

DHCP 399

disassembly 580, 587

Discrete Parameters 209

display 31

DISPlay 258-261

DISPlay Subsystem 257

display view 261

DNS 400

DOMain 400

DOWNload 336

DSSC 216

DUAL view 261

---

duty cycle 293, 299, 360

Duty Cycle 46

Duty Cycle of a Square  
Wave 46

DWELL 318

## E

edge time 292, 296

embedded waveform  
editor 74

Embedded Waveform  
Editor 173

ENABLE 320, 376, 378,  
390

End-Or-Identify 208

entering numbers 32

ERRor 351, 391, 393-  
394

error messages 505, 555

Error Messages 454

Error Messages, Sorted  
by Error Code 454

errors 505, 555

ESE 307

ESR? 307

EVENT 376, 378

Event Status Enable 310

example programs 425

Ext Trig BNC 411

EXTernal 209

external timebase  
reference 171

---

## F

Factory Reset 312, 389,  
448, 455

features 86

FEED 246

FIFO 455

First-in-first-out 455

flatness 484, 486, 495,  
497, 502-503, 517,  
521, 525, 538, 540,  
542, 549, 551, 553

FM 107, 218, 220, 233,  
235, 263-265, 267,  
276, 278, 355, 357,  
362, 364

FM Subsystem 261

FNAME 336

FOCUS 258

FORMat 249, 268, 304

FREE 256

frequency 489, 531

Frequency 38, 123, 132,  
140, 152, 158, 164,  
474, 479, 508, 514

FREQuency 217, 264,  
269-273, 275, 284,  
319, 323, 354, 361,  
382

Frequency-Shift  
Keying 121

frequency list 429

frequency  
modulation 107

---

FREQuency

Subsystem 268

frequency sweep 58

front-panel menus 65

front panel 30-32, 65

FSK 55, 121

FSK waveform 55

FSKey 218, 220, 233,  
235, 265, 267,  
275-276, 278, 355,  
357, 362, 364

FSKey Subsystem 274

FUNction 217, 264, 281-  
290, 292-303, 354,  
361, 367, 383

FUNction  
Subsystem 279

functions 86

## G

GAIN 301

GATE 239

GATeway 401

GPIB 390, 454

GPIB option 594

GRAPh view 261

## H

Handle 37

Hardware Address 403

HCOPY 304

HCOPY Subsystem 303

---

Help 49  
Help system 49  
HIGH 420-421  
High-Level 44  
High-Level Value 44  
HNAME 320  
HOLD 294  
HOSTname 402  
HTIME 386

**I**

I/O 454  
    queue 454  
IDENTify 320  
IDN? 308  
IEEE-488 Common  
    Commands 304  
IMMediate 209, 317,  
    388, 397  
INITiate 316-317  
INITiate Subsystem  
    Introduction 316  
Input attenuation 318  
INSTall 394  
Instrument Preset 389  
instrument state 63  
INTernal 217, 232, 239,  
    264, 275, 354, 361,  
    382-383  
internal ADC 490, 532  
Internal Function 210

internal timebase 481,  
    489, 515, 531  
Introduction 206  
    SCPI Language 206  
Introduction to  
    instrument 28  
IPAdDress 403  
IQ Player 155  
IQ Waveform 155

**K**

Keysight IO Libraries  
    Suite 17

**L**

LAN 398-407  
LAN Configuration 71,  
    397  
LEADing 296  
LEVel 411  
LICense 392-394  
LIMit 421-422  
LIST 318-319, 337  
list of frequencies 429  
LIST Subsystem 318  
LOAD 336-338, 341  
Local key 258  
LOCK 395-396  
LOW 420-421  
Low-Level 44  
Low-Level Value 44

---

LXI 320-322  
LXI Subsystem 319

**M**

MAC 403  
MARKer 323-324  
MARKer Subsystem 322  
Master Summary 312-  
    313  
MDIRectory 334  
MDNS 320-321  
MEMory 325-326  
MEMory Subsystem 324  
menus 65  
Message Available 312-  
    313  
MMEMory 331-339  
MMEMory  
    Subsystem 327  
MODE 240, 271-272,  
    342, 344, 365  
modulated waveform 54  
modulation 54  
MODulation 350  
Modulation  
    attenuation 318  
MOVE 338

**N**

NAME 395  
NCYCles 240  
NOISe 225, 289

---

Notices, safety 3, 5  
NSTates 325  
number entry 32  
numeric keypad 32  
Numeric Parameters 209

## O

offset 483, 516  
OFFSet 271, 300, 302,  
366, 423  
OPC 208, 309  
OPC? 309  
operating information 16  
OPERation 375-376  
OPT? 309  
OUTPut 340-347  
Output Amplitude 40  
output channels 86  
output configuration 86  
Output Frequency 38,  
123, 132, 140, 152,  
158, 164, 474, 479,  
508, 514  
output impedance 492,  
498, 534, 544  
OUTPut Subsystem 339  
output termination 53  
OWNer 395

## P

Parameter Settings 208  
Querying 208

parts 579  
password 477, 512  
performance  
verification 479,  
514  
PERiod 239, 284, 295,  
300  
PHASe 232, 241, 288,  
348-351  
Phase Modulation 115  
PHASe Subsystem 347  
PM 115, 218, 220, 233,  
235, 265, 267, 276,  
278, 353-355, 357,  
362, 364  
PM Subsystem 351  
POINT 324  
POINTs 253, 285, 319  
POLarity 239, 342, 345  
power-on self-test 571  
Power-On Status  
Clear 310  
power supplies 561-562  
PRBS 226, 290, 292  
PRESet 376  
PRNoise 289  
program examples 425  
PROMpt 405  
PSC 310  
PTPeak 253, 286  
pulse 101, 428  
Pulse 47

PULSe 227, 259, 293-  
297  
pulse wave 101, 428  
Pulse Waveform 47  
pulse width  
modulation 56  
PWM 56, 218, 220, 233,  
235, 265, 267, 276,  
278, 355, 357,  
359-362, 364

PWM Subsystem 358  
PWM waveform 56

## Q

Querying 208  
Parameter  
Settings 208  
Status Byte  
Register 313  
QUESTionable 377-378  
Questionable Data  
Register 310  
queries 378  
Questionable Data  
Summary 312-313  
Queue 454  
I/O 454  
Quick command  
reference 431

## R

rack 51  
rack mount 51



---

ramp 427  
RAMP 228, 298  
ramp wave 427  
RANGe 424  
RATE 232, 260, 365-366  
RATE Subsystem 365  
RATio 272, 367  
RDIRectory 334  
rear panel 33  
RECall 326  
REFerence 350, 431  
registers 314  
RELease 395  
repair 470  
replaceable parts 579  
REQuest 312, 396  
reset 53, 448  
RESet 322  
reset instrument 53  
RESolved 321  
REStArt 322  
ROSCillator 368-369  
ROSCillator  
    Subsystem 367  
RST 208, 312, 326  
RTIME 386

## S

Safety information 2  
Safety notices 3, 5

---

Safety symbols 3  
sample programs 425  
sample rate 287, 365-367  
SAV 311  
SCPI 206  
    commands by  
        subsystem 20,  
        22, 212  
    quick reference 431  
SCPI Command  
    Terminators 208  
SCPI Language 206  
    Introduction 206  
SCPI Parameter  
    Types 209  
SCPI Status System 455  
SDUMp 304  
SECure 243-244  
security 477, 512  
SECurity 397  
Select stored arbitrary  
    waveform 48  
self-test 489, 531, 562,  
    566, 571  
Self-test 314  
SEQuence 254, 335  
Serial Poll 313  
service 470  
Service 312

---

Service Request  
    enable 310  
Set DC Offset Voltage 42  
Set DC Voltage 45  
Set Duty Cycle of a  
    Square Wave 46  
Set High-Level Value 44  
Set Low-Level Value 44  
Set Output Amplitude 40  
Set Output  
    Frequency 38,  
    101, 115, 123, 132,  
    140, 152, 158, 164,  
    474, 479, 508, 514  
SETup 244  
sine 425  
sine wave 425  
SINusoid 229  
SKEW 302-303  
SLOPe 347, 411  
SMASk 404  
SNAME 321  
SOURce 218, 233, 265,  
    276, 345, 347, 355,  
    362, 368-369, 384,  
    412  
SOURce Subsystem 370  
SPACing 386  
SPAN 273  
square 426  
SQUare 230, 299-300  
square wave 426

SRATe 287, 367	Sum 128	TRG 313
SRE 312	SUM 381-384	TRlangle 228
Standard Event Register 310	sum modulation 128	TRIGger 346-347, 410-413
Standard Event Summary 312-313	SUM Subsystem Introduction 379	trigger burst 62
Standard Operation Register 310, 312-313	Support 6	TRIGger Subsystem Introduction 148, 410
Standard Operation Summary 312-313	sweep 58, 62	trigger sweep 62
STANdard view 261	SWEep 260, 386-387	troubleshooting 562, 566
START 273	SWEep Subsystem Introduction 385	TST? 314
state 63, 448	Symbols, safety 3	tutorial 190, 489, 531
STATe 220, 235, 241, 244, 267, 270, 278, 302, 320, 322, 325-326, 333, 338, 351, 357, 364-365, 384, 387, 389, 422	SYMMetry 298	
STATus 375-378	SYNC 343-345	<b>U</b>
Status Byte 312	SYNChronize 288, 351	UNIT 259-260, 414, 416, 425
Status Byte Register 310, 312-313	Syntax Conventions 206	UNLock 351
STATus Subsystem Introduction 372	SYSTEM 388-407	UPDate 406
Status System Diagram 372	<b>T</b>	UPLoad 339
STB? 313	Technical support 6	Using Device Clear 210
STOP 273	TELNet 405	
STORe 244, 336-339	termination 53	<b>V</b>
store state 63	TEXT 208, 258-259, 261	VALid 326
STRing 245	TEXT view 261	VALue 245
	TIME 303, 387, 397	verification 479, 481-483, 498, 513-516, 544
	timebase 171, 489, 531	VERsion 397
	timebase,external 171	VIEW 261
	TIMer 413	VOLatile 256
	TRACk 408	VOLTage 418-425
	TRAIling 296	
	TRANSition 292, 296	

---

VOLTage Subsystem  
Introduction 416

**W**

WAI 314

Wait-for-trigger 313,  
412

Waveform Editor 173

Web Interface 18

WIDTh 297

WINS 407

WMESsage 405



This information is subject to change without notice.

© Keysight Technologies 2013-2023  
Edition 6, December 2023

Printed in Malaysia



33500-90901

[www.keysight.com](http://www.keysight.com)

# Générateur de signaux Keysight Technologies Série Trueform

Guide d'utilisation  
et de maintenance

# Informations de sécurité et réglementaires

## Avertissements

© Keysight Technologies, Inc. 2013 - 2020

Conformément aux lois internationales relatives à la propriété intellectuelle, toute reproduction, tout enregistrement électronique et toute traduction de ce manuel, totalement ou en partie, sous quelque forme et par quelque moyen que ce soit, sont interdits sauf accord écrit préalable de la société Keysight Technologies, Inc.

## Informations sur le manuel

Référence : 33500-90912, édition 3, novembre 2020

## Adresse du fabricant

Keysight Technologies, Inc.  
900 S. Taft Ave.  
Loveland, CO 80537 États-Unis

## Logiciels et documentation - Mises à jour et licences

Keysight publie des mises à jour des logiciels pour corriger des défauts recensés et améliorer le produit. Pour obtenir le dernier microprogramme et la dernière documentation, rendez-vous sur [www.keysight.com/find/trueform](http://www.keysight.com/find/trueform).

Une partie du logiciel de ce produit est soumise à licence selon les termes de General Public License Version 2 (« GPLv2 »). Le texte de la licence et le code source sont disponibles à l'adresse [www.keysight.com/find/GPLV2](http://www.keysight.com/find/GPLV2).

Ce produit utilise Microsoft Windows CE. Keysight recommande vivement l'utilisation d'un logiciel anti-virus courant sur tous les ordinateurs Windows connectés aux instruments Windows CE. Pour de plus amples informations, rendez-vous sur [www.keysight.com/find/trueform](http://www.keysight.com/find/trueform).

## Garantie

Les informations contenues dans ce document sont fournies « en l'état » et peuvent faire l'objet de modifications sans préavis dans les éditions ultérieures. Dans les limites de la législation en vigueur, Keysight exclut en outre toute garantie, expresse ou implicite, concernant ce manuel et les informations qu'il contient, y compris, mais non exclusivement, les garanties de qualité marchande et d'adéquation à un usage particulier. Keysight ne saurait en aucun cas être tenu responsable des erreurs ou des dommages incidents ou indirects, liés à la fourniture, à l'utilisation ou à l'exactitude de ce document ou aux performances de tout produit Keysight auquel il se rapporte. Si Keysight a passé un contrat écrit avec l'utilisateur et que certains termes de ce contrat semblent contradictoires avec ceux de ce document, les termes et conditions de la garantie prévalent.

## Licences technologiques

Le matériel et le logiciel décrits dans ce document sont protégés par un accord de licence ; leur utilisation ou leur reproduction est soumise aux termes et conditions de ladite licence.

## Légende de limitation des droits

Si le logiciel est utilisé par un représentant direct ou indirect du gouvernement des États-Unis d'Amérique, le logiciel est livré et commercialisé en tant que logiciel informatique commercial selon les directives DFAR 252.227-7014 (juin 1995), ou en tant qu'article commercial selon la directive FAR 2.101(a) ou logiciel informatique limité selon la directive FAR 52.227-19 (juin 1987) ou toute règle ou clause de contrat équivalents. L'utilisation, la duplication ou la divulgation du logiciel est régie par les termes habituels de la licence commerciale de Keysight Technologies. Les départements ne faisant pas partie de la Défense (DOD) et agences gouvernementales des États-Unis d'Amérique recevront des droits limités comme l'indique la directive FAR 52.227-19 (c)(1-2) (juin 1987). Le gouvernement des États-Unis d'Amérique recevra des droits limités comme définis par la directive FAR 52.227-14 (juin 1987) ou DFAR 252.227-7015 (b)(2) (novembre 1995) et applicables pour toutes informations techniques.

## Consignes de sécurité

### ATTENTION

La mention ATTENTION signale un danger. Elle attire l'attention sur une procédure ou une pratique qui, si elle n'est pas respectée ou correctement réalisée, peut se traduire par des dommages à l'appareil ou une perte de données importante. En présence de la mention ATTENTION, il convient de cesser toute utilisation tant que les conditions indiquées n'ont pas été parfaitement comprises et respectées.

### AVERTISSEMENT

La mention AVERTISSEMENT signale un danger. Elle attire l'attention sur une procédure ou une pratique qui, si elle n'est pas respectée ou correctement réalisée, peut se traduire par des accidents graves, voire mortels. En présence de la mention AVERTISSEMENT, il convient de cesser toute utilisation tant que les conditions indiquées n'ont pas été parfaitement comprises et respectées.

## Symboles de sécurité



Courant alternatif

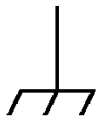

Borne reliée au cadre ou au châssis (masse fonctionnelle)



Alimentation en mode veille. L'appareil n'est pas complètement déconnecté du secteur si l'interrupteur est à l'arrêt.



**AVERTISSEMENT** Risque d'électrocution



**ATTENTION** Consulter la documentation fournie



Borne de terre de protection (masse de sécurité)



Le marquage CE est une marque déposée de la Communauté européenne.



La marque ETL est une marque déposée de la société Intertek. S'applique uniquement aux instruments série 33500.



Le marquage CSA accompagné des mentions « c » et « us » signifie que le produit est certifié conforme aux normes américaines et canadiennes pour le marché américain et le marché canadien, respectivement. S'applique uniquement aux instruments série 33600.



N10149

Le marquage C-tick est une marque déposée de l'agence australienne Spectrum Management Agency. Il indique la conformité aux règles de l'Australian EMC Framework selon les termes de la loi Radiocommunications Act de 1992.



Contient une ou plusieurs des 6 substances dangereuses supérieures à la valeur de concentration maximale (MCV), période d'utilisation de protection environnementale (EPUP) de 40 ans.

1SM 1-A

Ce texte indique un appareil industriel, scientifique et médical de classe A et du groupe 1 (CISPR 11, clause 4).

ICES/NMB-001

Cet appareil ISM est conforme à la norme ICES-001 du Canada.

Cet appareil ISM est conforme à la norme NMB-001 du Canada.



Ce produit est conforme aux équipements marqués selon la Directive WEEE (2002/96/CE). L'étiquette apposée sur le produit indique que vous ne devez pas le jeter avec les ordures ménagères.

Pour retourner les produits inutilisés, contactez votre distributeur Keysight le plus proche ou consultez le site [www.-keysight.com/environment/product](http://www.keysight.com/environment/product) pour de plus amples informations.



Cet équipement appartient à la classe A adaptée à un usage professionnel et est conçu pour être utilisé dans des environnements électromagnétiques non résidentiels.

이 기기는 업무용 (A 급) 전자파적합기기로서 판매자 또는 사용자는 이 점을 주의하시기 바라며, 가정외의 지역에서 사용하는 것을 목적으로 합니다.



## Consignes de sécurité supplémentaires

Les consignes de sécurité présentées dans cette section doivent être appliquées au cours des différentes phases d'utilisation de cet instrument. Le non-respect de ces précautions ou des avertissements et instructions spécifiques mentionnés dans ce manuel constitue une violation des normes de sécurité établies lors de la conception, de la fabrication et de l'usage normal de l'instrument. Keysight Technologies ne saurait être tenu pour responsable du non-respect de ces consignes.

### Généralités

N'utilisez ce produit que de la manière préconisée par le fabricant. Les fonctions de sécurité de ce produit peuvent être perturbées si vous ne respectez pas les consignes d'utilisation.

### Avant la mise sous tension

Vérifiez que vous avez bien respecté toutes les consignes de sécurité. Effectuez tous les branchements à l'appareil avant de le mettre sous tension.

### Mise à la terre de l'instrument

Ce produit comporte des bornes de terre de protection. Afin de réduire les risques électriques, l'instrument doit être relié à une source de courant alternatif par l'intermédiaire d'un cordon d'alimentation secteur pourvu d'un fil de terre connecté fermement à une terre électrique (terre de sécurité) au niveau de la prise de courant. Toute interruption du conducteur de protection (mise à la terre) ou tout débranchement de la borne de terre de protection présente un risque d'électrocution susceptible de provoquer des accidents graves.

- N'utilisez pas l'instrument en atmosphère explosive.
- Ne pas faire fonctionner l'instrument en présence de vapeur ou de gaz inflammables ou dans un environnement humide.
- Seules des personnes qualifiées, formées à la maintenance et conscientes des risques d'électrocution encourus peuvent déposer les capots de l'instrument. Débranchez toujours le cordon d'alimentation et tous les circuits externes avant de déposer le capot de l'instrument.

### Ne modifiez pas l'instrument

N'installez pas de composants de remplacement et n'apportez aucune modification non autorisée à l'appareil. Pour toute opération de maintenance ou de réparation, renvoyez l'appareil à une agence commerciale et de service après-vente Keysight afin d'être certain que les fonctions de sécurité seront conservées.

## En cas de dommages

Les instruments endommagés ou défectueux doivent être désactivés et protégés contre toute utilisation involontaire jusqu'à ce qu'ils aient été réparés par une personne qualifiée.

### ATTENTION

Sauf mention contraire dans les caractéristiques techniques, cet instrument ou ce système est destiné à un usage dans un local abrité, une installation de catégorie II et dans un environnement de degré de pollution 2 selon les normes CEI 61010-1 et respectivement. Il est conçu pour fonctionner avec une humidité relative maximale de 5 à 80 % à 40 °C au maximum (sans condensation). Cet instrument ou ce système est conçu pour fonctionner jusqu'à 3 000 mètres d'altitude et à des températures comprises entre 0 et 55 °C.

## Support technique

Pour toute question concernant votre livraison ou pour obtenir des informations sur la garantie, la maintenance ou l'assistance technique, [contactez Keysight Technologies](#).

## Declaration of Conformity

Declarations of Conformity for this product and for other Keysight products may be downloaded from the Keysight Regulatory Web site:

<http://regulations.products.keysight.com/DoC/search.htm>

## Modèles et options

Ce chapitre décrit les modèles et options de la série d'instruments Trueform. Pour plus d'informations sur le chargement des licences des options via la face avant, reportez-vous à la section [Installation des licences](#). Pour plus d'informations sur le chargement de licences, reportez-vous à la section [Commandes SYSTem:LIcense](#).

## Modèles d'instrument

Les modèles d'instruments dont les numéros se présentent sous la forme 335XXA ou 335XXB désignent la série 33500, alors que les modèles d'instruments présentant des numéros de type 336XXA se rapportent à la série 33600. Ensemble, les instruments série 33500 et série 33600 comprennent les générateurs de signaux série Trueform. Sauf indication contraire, toutes les rubriques du manuel s'appliquent à l'ensemble des instruments de la série Trueform.

Pour déterminer le numéro de modèle de votre instrument, consultez l'étiquette figurant sur la face avant de l'instrument. Vous pouvez également exécuter la requête \*IDN? sur l'interface distante ou appuyer sur les touches **[System] > Help > About** de la face avant.

Les numéros des modèles et des options de la série Trueform sont présentés et décrits dans le tableau ci-dessous.

Informations de sécurité et réglementaires

<b>Modèle</b>	<b>Description</b>	<b>Options</b>
33521A	30 MHz Une voie Signaux arbitraires Sécurité NISPOM Mémoire 1 M.éch par voie	002 - Mémoire de signaux arbitraires 16 Méch 004 - Interface GPIB 010 - Base de temps haute stabilité OCXO
33522A	30 MHz Deux voies Signaux arbitraires Sécurité NISPOM Mémoire 1 M.éch par voie	002 - Mémoire de signaux arbitraires 16 Méch 004 - Interface GPIB 010 - Base de temps haute stabilité OCXO
33509B	20 MHz Une voie Aucun signal arbitraire	OCX - Ajouter la base de temps OCXO haute stabilité SEC - Activer la sécurité NISPOM et des fichiers
33510B	20 MHz Deux voies Aucun signal arbitraire	OCX - Ajouter la base de temps OCXO haute stabilité SEC - Activer la sécurité NISPOM et des fichiers
33511B	20 MHz Une voie Signaux arbitraires	MEM - Mémoire 16 Méch par voie OCX - Ajouter la base de temps OCXO haute stabilité SEC - Activer la sécurité NISPOM et des fichiers
33512B	20 MHz Deux voies Signaux arbitraires	MEM - Mémoire 16 Méch par voie OCX - Ajouter la base de temps OCXO haute stabilité SEC - Activer la sécurité NISPOM et des fichiers IQP - lecteur de signaux IQ en bande de base
33519B	30 MHz Une voie Aucun signal arbitraire	OCX - Ajouter la base de temps OCXO haute stabilité SEC - Activer la sécurité NISPOM et des fichiers
33520B	30 MHz Deux voies Aucun signal arbitraire	OCX - Ajouter la base de temps OCXO haute stabilité SEC - Activer la sécurité NISPOM et des fichiers
33521B	30 MHz Une voie Signaux arbitraires	MEM - Mémoire 16 Méch par voie OCX - Ajouter la base de temps OCXO haute stabilité SEC - Activer la sécurité NISPOM et des fichiers
33522B	30 MHz Deux voies Signaux arbitraires	MEM - Mémoire 16 Méch par voie OCX - Ajouter la base de temps OCXO haute stabilité SEC - Activer la sécurité NISPOM et des fichiers IQP - lecteur de signaux IQ en bande de base
33611A	80 MHz Une voie Signaux arbitraires	MEM - Mémoire 64 Méch par voie OCX - Ajouter la base de temps OCXO haute stabilité SEC - Activer la sécurité NISPOM et des fichiers
33612A	80 MHz Deux voies Signaux arbitraires	MEM - Mémoire 64 Méch par voie OCX - Ajouter la base de temps OCXO haute stabilité SEC - Activer la sécurité NISPOM et des fichiers IQP - lecteur de signaux IQ en bande de base

Modèle	Description	Options
33621A	120 MHz Une voie Signaux arbitraires	MEM - Mémoire 64 M.éch par voie OCX - Ajouter la base de temps OCXO haute stabilité SEC - Activer la sécurité NISPOM et des fichiers Module d'interface GPB - GPIB – installé en usine
33622A	120 MHz Deux voies Signaux arbitraires	MEM - Mémoire 64 M.éch par voie OCX - Ajouter la base de temps OCXO haute stabilité SEC - Activer la sécurité NISPOM et des fichiers IQP - lecteur de signaux IQ en bande de base Module d'interface GPB - GPIB – installé en usine

## Mises à niveau une et deux voies pour la série 33500

Modèle	Description
335BW1U	Augmenter la bande passante à 30 MHz pour les modèles 1 voie
335BW2U	Augmenter la bande passante à 30 MHz pour les modèles 2 voies
335ARB1U	Ajouter des signaux arbitraires aux modèles 1 voie
335ARB2U	Ajouter des signaux arbitraires aux modèles 2 voies
335MEM1U	Mémoire 16 M.éch par voie pour les modèles 1 voie
335MEM2U	Mémoire 16 M.éch par voie pour les modèles 2 voies
33500U-OCX	Ajouter une base de temps haute stabilité OCXO
335SECU	Ajouter les fonctions de sécurité NISPOM et la sécurité des fichiers
33522B-DST	Activer toutes les options logicielles à des fins de démonstration

## Mises à niveau une et deux voies pour la série 33600

Modèle	Description
336BW1U	Augmenter la bande passante à 120 MHz pour les modèles 1 voie
336BW2U	Augmenter la bande passante à 120 MHz pour les modèles 2 voies
336MEM1U	Mémoire 64 M.éch par voie pour les modèles 1 voie
336MEM2U	Mémoire 64 M.éch par voie pour les modèles 2 voies
33600U-OCX	Ajouter une base de temps haute stabilité OCXO
336SECU	Ajouter les fonctions de sécurité NISPOM et la sécurité des fichiers
33622A-DST	Activer toutes les options logicielles à des fins de démonstration
3446GPBU	Module d'interface installable par l'utilisateur GPIB

## Fréquences de signal maximales par modèle

Série 33500, modèles de fréquence inférieure

**33509B 33510B 33511B 33512B**

<b>Signal</b>	<b>Fréquence maximale</b>
Sinusoïdal	20 MHz
Carré/Impulsion	20 MHz
Bruit	20 MHz
Rampe/triangle	200 kHz
PRBS	50 Mbits/s
Arbitraire	160 Méch/s

Série 33500, modèles de fréquence supérieure

**33521A 33522A 33519B 33520B 33521B 33522B** ou autres modèles série 33500 dotés de l'option **335BW1U** ou **335BW2U**.

<b>Signal</b>	<b>Fréquence maximale</b>
Sinusoïdal	30 MHz
Carré/Impulsion	30 MHz
Bruit	30 MHz
Rampe/triangle	200 kHz
PRBS	50 Mbits/s
Arbitraire	250 Méch/s

Série 33600, modèles de fréquence inférieure

**33611A 33612A**

<b>Signal</b>	<b>Fréquence maximale</b>
Sinusoïdal	60 MHz jusqu'à 10 Vpp 80 MHz jusqu'à 8 Vpp
Carré/Impulsion	50 MHz jusqu'à 10 Vpp

Signal	Fréquence maximale
Bruit	60 MHz jusqu'à 10 Vpp 80 MHz jusqu'à 8 Vpp
Rampe/triangle	800 kHz
PRBS	100 Mbits/s
Arbitraire	660 Méch/s

Série 33600, modèles de fréquence supérieure

**33621A 33622A** ou autres modèles série 33600 dotés de l'option 336BW1U ou 336BW2U.

Signal	Fréquence maximale
Sinusoïdal	60 MHz jusqu'à 10 Vpp 80 MHz jusqu'à 8 Vpp 120 MHz jusqu'à 4 Vpp
Carré/Impulsion	50 MHz jusqu'à 10 Vpp 100 MHz jusqu'à 4 Vpp
Bruit	60 MHz jusqu'à 10 Vpp 80 MHz jusqu'à 8 Vpp 120 MHz jusqu'à 4 Vpp
Rampe/triangle	800 kHz
PRBS	100 Mbits/s jusqu'à 10 Vpp 200 Mbits/s jusqu'à 4 Vpp
Arbitraire	1 Géch/s

<b>Informations de sécurité et réglementaires</b> .....	<b>2</b>
<b>Avertissements</b> .....	<b>2</b>
Informations sur le manuel .....	2
<b>Adresse du fabricant</b> .....	<b>2</b>
Logiciels et documentation - Mises à jour et licences .....	2
Garantie .....	2
Licences technologiques .....	3
Légende de limitation des droits .....	3
<b>Consignes de sécurité</b> .....	<b>3</b>
<b>Symboles de sécurité</b> .....	<b>3</b>
<b>Consignes de sécurité supplémentaires</b> .....	<b>5</b>
Généralités .....	5
Avant la mise sous tension .....	5
Mise à la terre de l'instrument .....	5
Ne modifiez pas l'instrument .....	5
En cas de dommages .....	6
Support technique .....	6
Declaration of Conformity .....	6
<b>Modèles et options</b> .....	<b>6</b>
Modèles d'instrument .....	6
Mises à niveau une et deux voies pour la série 33500 .....	8
Mises à niveau une et deux voies pour la série 33600 .....	8
<b>Fréquences de signal maximales par modèle</b> .....	<b>9</b>
Série 33500, modèles de fréquence inférieure .....	9
Série 33500, modèles de fréquence supérieure .....	9
Série 33600, modèles de fréquence inférieure .....	9
Série 33600, modèles de fréquence supérieure .....	10
<b>Logiciel Keysight BenchVue</b> .....	<b>19</b>
<b>Le logiciel BenchVue permet d'effectuer les opérations suivantes :</b> .....	<b>19</b>
<b>Gagnez un temps précieux grâce aux fonctions suivantes :</b> .....	<b>19</b>
<b>Accédez depuis n'importe où à :</b> .....	<b>19</b>
<b>Informations préliminaires</b> .....	<b>20</b>
<b>Consignes d'utilisation</b> .....	<b>20</b>
<b>Référence de programmation SCPI</b> .....	<b>20</b>
<b>Informations d'entretien et de réparation</b> .....	<b>21</b>
<b>Bibliothèques d'entrées/sorties et pilotes de l'instrument</b> .....	<b>21</b>
<b>Interface Web</b> .....	<b>22</b>
<b>Exemples de programmes</b> .....	<b>22</b>
<b>Contactez Keysight Technologies</b> .....	<b>23</b>
<b>Consignes d'utilisation</b> .....	<b>24</b>
<b>Présentation de l'instrument</b> .....	<b>24</b>
Présentation succincte de l'instrument .....	24
Présentation succincte de la face avant .....	26
Présentation succincte de l'écran de la face avant .....	27
Saisie d'une valeur numérique sur la face avant .....	28
Présentation succincte de la face arrière .....	29
<b>Mise en route</b> .....	<b>30</b>
Préparation de l'instrument .....	32
Réglage de la poignée de transport .....	33

Réglage de la fréquence de sortie .....	34
Réglage de l'amplitude de sortie .....	35
Réglage de la tension CC résiduelle .....	37
Définition des valeurs haute et basse .....	38
Envoi d'une tension continue .....	39
Réglage du rapport cyclique d'un signal carré .....	40
Configuration d'un train d'impulsions .....	41
Sélection d'un signal arbitraire prédéfini .....	42
Utilisation de l'aide intégrée .....	43
Montage de l'instrument dans une baie .....	45
<b>Utilisation des menus de la face avant .....</b>	<b>46</b>
Sélection de l'impédance de sortie .....	47
Réinitialisation de l'instrument .....	47
Envoi d'un signal modulé .....	48
Envoi d'un signal FSK .....	49
Envoi d'un signal PWM .....	51
Envoi d'un balayage en fréquence .....	53
Envoi d'un signal en rafale .....	55
Déclenchement d'un balayage ou d'une rafale .....	56
Enregistrement ou récupération de la configuration de l'instrument .....	57
Aide-mémoire des menus de la face avant .....	59
Procédure de configuration du réseau local .....	65
Configuration d'un signal arbitraire .....	67
<b>Caractéristiques et fonctions .....</b>	<b>78</b>
Configuration de la sortie .....	79
Trains d'impulsions .....	94
Modulation d'amplitude (AM) et modulation de fréquence (FM) .....	99
Modulation de phase (PM) .....	106
Modulation par déplacement de fréquence (FSK) .....	112
Modulation de largeur d'impulsion (PWM) .....	114
Modulation par addition .....	119
Balayage en fréquence .....	122
Mode rafale .....	131
Déclenchements .....	137
Opérations sur 2 voies .....	142
IQ Player (option) .....	145
Opérations système .....	148
Configuration de l'interface distante .....	154
Référence de base de temps externe .....	163
Éditeur de signaux intégré .....	165
<b>Didacticiel de génération de signaux .....</b>	<b>179</b>
Signaux arbitraires .....	180
Bruit quasi-gaussien .....	184
PRBS .....	184
Modulation .....	185
Rafale .....	189
Balayage en fréquence .....	190
Attributs des signaux CA .....	191
Imperfections des signaux .....	193
Boucles de masse .....	195
<b>Référence de programmation SCPI .....</b>	<b>196</b>
<b>Présentation du langage SCPI .....</b>	<b>196</b>



Conventions syntaxiques .....	196
Séparateurs de commandes .....	197
Utilisation des paramètres MIN, MAX et DEF .....	197
Requêtes sur les paramètres .....	198
Caractères de fin de commande SCPI .....	198
Commandes courantes IEEE-488.2 .....	198
Types de paramètres SCPI .....	199
Utilisation du message Device Clear .....	200
<b>Signaux de fonctions internes .....</b>	<b>200</b>
Voir également .....	202
<b>Liste alphabétique des commandes et des requêtes SCPI .....</b>	<b>202</b>
ABORt .....	204
Sous-système AM .....	204
Sous-système APPLy .....	212
Sous-système BPSK .....	224
Sous-système BURSt .....	230
Sous-système CALibration .....	236
[SOURce[1 2]:]COMBine:FEED {CH1 CH2 NONE}[SOURce[1 2]:]COMBine:FEED? .....	242
Sous-système DATA .....	243
Sous-système DISPlay .....	252
Sous-système FM .....	257
FORMat:BORDER {NORMal SWAPped}FORMat:BORDER? .....	266
Sous-système FREQuency .....	266
Sous-système FSKey .....	271
Sous-système FUNCtion .....	277
Sous-système HCOpy .....	303
Commandes courantes IEEE-488 .....	304
Sous-système INITiate .....	316
INPut:ATTenuation[:STATe] {ON 1 OFF 0}INPut:ATTenuation[:STATe]? .....	318
Sous-système LIST .....	318
Sous-système LXI .....	319
Sous-système MARKer .....	322
Sous-système MEMory .....	324
Sous-système MMEMory .....	328
Sous-système OUTPut .....	342
Sous-système PHASe .....	351
Sous-système PM .....	355
Sous-système PWM .....	363
Sous-système RATE .....	371
Sous-système ROSCillator .....	373
Sous-système SOURce .....	376
Présentation du sous-système STATus .....	378
Présentation du sous-système SUM .....	385
Présentation du sous-système SWEep .....	391
Sous-système SYSTem .....	393
[SOURce[1 2]:]TRACk {ON OFF INVerted}TRACk? .....	416
Présentation du sous-système TRIGger .....	418
UNIT:ANGLe {DEGree RADian SECond DEFault}UNIT:ANGLe? .....	424
UNIT:ARBitrary:ANGLe {DEGree RADian SECond SAMPlE DEFault}UNIT:ARBitrary:ANGLe? .....	426
Présentation du sous-système VOLTage .....	426
<b>Exemples de programmation .....</b>	<b>437</b>
Configurer un signal sinusoïdal .....	437
Configurer un signal carré .....	438

Configurer une rampe .....	439
Configurer un train d'impulsions .....	440
Créer une liste de fréquences .....	441
Configurer un signal arbitraire .....	441
<b>Aide-mémoire des commandes Keysight série Trueform .....</b>	<b>443</b>
<b>Réinitialisation de la configuration d'usine .....</b>	<b>461</b>
<b>Messages d'erreur SCPI .....</b>	<b>468</b>
<b>Entretien et réparation - Introduction .....</b>	<b>482</b>
<b>Types d'interventions et de contrats de maintenance possibles .....</b>	<b>482</b>
Contrats de maintenance longue durée .....	482
Trouver un service de réparation (international) .....	482
Remballage pour expédition .....	483
<b>Nettoyage .....</b>	<b>483</b>
<b>Précautions contre les décharges électrostatiques (ESD) .....</b>	<b>483</b>
<b>Présentation de l'étalonnage - Série 33500 .....</b>	<b>483</b>
Services d'étalonnage Keysight Technologies .....	484
Étalonnage - Table des matières .....	484
Présentation de l'étalonnage - Série 33500 .....	485
Sécurité de l'étalonnage - Série 33500 .....	488
Vérification - Série 33500 .....	491
Tests de vérification des performances - Série 33500 .....	491
Vérification de la base de temps interne - Série 33500 .....	492
Vérification de l'amplitude CA (haute impédance) - Série 33500 .....	493
Vérification de la tension CC résiduelle - Série 33500 .....	494
Vérification de la planéité dans la plage -8 dB - Série 33500 .....	495
Vérification de la planéité dans la plage -24 dB - Série 33500 .....	497
Procédure générale d'étalonnage/réglage - Série 33500 .....	498
Abandon d'un étalonnage en cours - Série 33500 .....	499
Ordre des réglages - Série 33500 .....	500
Autotest - Série 33500 .....	500
Réglage de la fréquence (base de temps interne) - Série 33500 .....	500
Réglage du convertisseur analogique/numérique (ADC) interne - Série 33500 .....	501
Réglage de l'auto-étalonnage - Série 33500 .....	502
Réglage de l'impédance de sortie - Série 33500 .....	503
Réglage de l'amplitude CA (haute impédance) - Série 33500 .....	504
Réglage de la planéité dans la plage -24 dB - Série 33500 .....	506
Réglage de la planéité dans la plage -8 dB - Série 33500 .....	507
Réglages de la voie 2 - Série 33500 .....	509
Erreurs d'étalonnage - Série 33500 .....	515
<b>Présentation de l'étalonnage - Série 33600 .....</b>	<b>517</b>
Services d'étalonnage Keysight Technologies .....	517
Étalonnage - Table des matières .....	517
Présentation de l'étalonnage - Série 33600 .....	519
Sécurité de l'étalonnage - Série 33600 .....	522
Vérification - Série 33600 .....	524
Tests de vérification des performances - Série 33600 .....	524
Vérification de la base de temps interne - Série 33600 .....	526
Vérification de l'amplitude CA (haute impédance) - Série 33600 .....	526
Vérification de la tension CC résiduelle - Série 33600 .....	527
Vérification de la planéité dans la plage 1 Vpp - Série 33600 .....	528
Vérification de la planéité dans la plage 4 Vpp - Série 33600 .....	532
Vérification de la planéité dans la plage 8 Vpp - Série 33600 .....	536

Procédure générale d'étalonnage/réglage - Série 33600 .....	541
Abandon d'un étalonnage en cours - Série 33600 .....	541
Ordre des réglages - Série 33600 .....	542
Autotest - Série 33600 .....	542
Réglage de la fréquence (base de temps interne) - Série 33600 .....	542
Réglage du convertisseur analogique/numérique (ADC) interne - Série 33600 .....	543
Réglage de l'auto-étalonnage - Série 33600 .....	544
Réglage de l'impédance de sortie - Série 33600 .....	545
Réglage de l'amplitude CA (haute impédance) - Série 33600 .....	546
Réglage de la planéité 1 Vpp - Série 33600 .....	548
Réglage de la planéité 4 Vpp - Série 33600 .....	551
Réglage de la planéité 8 Vpp - Série 33600 .....	553
Réglages de la voie 2 - Série 33600 .....	554
Erreurs d'étalonnage - Série 33600 .....	564
<b>Schéma fonctionnel - Série 33500 .....</b>	<b>566</b>
Schéma fonctionnel - Série 33500 .....	568
<b>Schéma fonctionnel - Série 33600 .....</b>	<b>568</b>
Schéma fonctionnel - Série 33600 .....	571
<b>Alimentations - Série 33500 .....</b>	<b>571</b>
<b>Alimentations - Série 33600 .....</b>	<b>572</b>
<b>Dépannage - Série 33500 .....</b>	<b>572</b>
L'appareil ne fonctionne pas .....	573
L'appareil échoue à l'autotest .....	573
Alimentations .....	573
Erreurs d'autotest 605 à 609 .....	574
Sortie 10 MHz .....	576
<b>Dépannage - Série 33600 .....</b>	<b>577</b>
L'appareil ne fonctionne pas .....	577
L'appareil échoue à l'autotest .....	577
Alimentations .....	577
Erreurs d'autotest 607 à 611 .....	580
Sortie 10 MHz .....	582
<b>Procédures d'autotest .....</b>	<b>583</b>
Autotest à la mise sous tension .....	583
Autotest complet .....	583
Pour exécuter l'autotest .....	583
Numéros et messages d'erreur des autotests (série 33500) .....	583
Numéros et messages d'erreur des autotests (série 33600) .....	587
<b>Pièces détachées .....</b>	<b>591</b>
<b>Démontage - Série 33500 .....</b>	<b>592</b>
Outillage nécessaire .....	592
Procédure générale de démontage .....	593
Démontage des principaux composants .....	594
Démontage de la face avant .....	597
<b>Démontage - Série 33600 .....</b>	<b>598</b>
Outillage nécessaire .....	598
Procédure générale de démontage .....	599
Démontage des principaux composants .....	600
Pour retirer la carte mère .....	602
<b>Remplacement de la batterie .....</b>	<b>603</b>
Outillage nécessaire .....	603
Procédure .....	604
<b>Installation de l'interface GPIB en option .....</b>	<b>605</b>

---

Outillage nécessaire .....	605
Procédure d'installation .....	605
Conservez le couvercle GPIB .....	605
<b>Index .....</b>	<b>608</b>



Ce document contient des informations sur l'utilisation, la maintenance et la programmation des générateurs de signaux Keysight série Trueform. Pour obtenir le dernier microprogramme et la dernière documentation, rendez-vous sur [www.keysight.com/find/trueform](http://www.keysight.com/find/trueform).

Pour obtenir la dernière fiche technique décrivant l'ensemble des spécifications et des caractéristiques type, consultez le document [literature.cdn.keysight.com/litweb/pdf/5991-3272EN.pdf](http://literature.cdn.keysight.com/litweb/pdf/5991-3272EN.pdf).

Keysight accueille vos commentaires et suggestions pour améliorer notre documentation. Vous pouvez faire parvenir vos remarques sur ce document à l'adresse [www.keysight.com/find/trueformdocfeedback](http://www.keysight.com/find/trueformdocfeedback).

## Logiciel Keysight BenchVue

Les générateurs de signaux Keysight série Trueform fonctionnent avec le logiciel BenchVue, qui permet de contrôler en toute simplicité plusieurs instruments. Pour de plus amples informations, rendez-vous sur [www.keysight.com/find/benchvue](http://www.keysight.com/find/benchvue).



Le logiciel BenchVue permet d'effectuer les opérations suivantes :

- Afficher et contrôler l'ensemble de vos instruments de paillasse à partir d'un écran unique
- Enregistrer/rappeler la configuration de votre paillasse complète
- Acquérir des données et des captures d'écran de plusieurs instruments

Gagnez un temps précieux grâce aux fonctions suivantes :

- Exportation synchronisée de plusieurs instruments vers Excel, Word, MATLAB
- Exportation des données du générateur de signaux vers Word
- Glisser-déposer des signaux entre votre générateur et l'oscilloscope
- Fonctionnalité de bibliothèque intégrée pour le téléchargement de la documentation de l'instrument, des pilotes logiciels, des mises à jour du microprogramme, des FAQ, des vidéos et bien plus

Accédez depuis n'importe où à :

- Des applications complémentaires mobiles pour surveiller et contrôler votre paillasse

## Informations préliminaires

Informations de sécurité et réglementaires

Modèles et options

Fréquences de signal maximales par modèle

## Consignes d'utilisation

Présentation de l'instrument

Mise en route

Utilisation des menus de la face avant

Aide-mémoire des menus de la face avant

Configuration du réseau local

Configuration d'un signal arbitraire

Caractéristiques et fonctions

Didacticiel de génération de signaux

## Référence de programmation SCPI

Présentation du langage SCPI

Signaux des fonctions internes

Liste alphabétique des commandes et des requêtes SCPI

Exemples de programmation

Aide-mémoire des commandes

Réinitialisation de la configuration d'usine

Messages d'erreur SCPI



## Informations d'entretien et de réparation

Présentation des opérations d'entretien et de réparation

Étalonnage et réglage : série 33500

Étalonnage et réglage : série 33600

Schéma fonctionnel - Série 33500

Schéma fonctionnel - Série 33600

Alimentations - Série 33500

Alimentations - Série 33600

Dépannage - Série 33500

Dépannage - Série 33600

Procédures d'autotest

Pièces détachées

Démontage - Série 33500

Démontage - Série 33600

Remplacement de la batterie

Installation de l'interface GPIB en option

## Bibliothèques d'entrées/sorties et pilotes de l'instrument

Le logiciel **Keysight IO Libraries Suite**, et notamment les instructions d'installation, sont disponibles sur le *CD Keysight IO Libraries Suite* accompagnant votre instrument.

Pour plus d'informations sur la connexion et la configuration des interfaces USB, LAN et GPIB, consultez le manuel *Keysight USB/LAN/GPIB Interfaces Connectivity Guide* situé sur le *CD Keysight IO Libraries Suite* et sur le site [www.keysight.com/find/connectivity](http://www.keysight.com/find/connectivity).

## Interface Web

L'instrument inclut une interface Web intégrée que vous pouvez utiliser sur le réseau local pour l'accès et le contrôle à distance de l'instrument via un navigateur Java™ tel que Microsoft Internet Explorer.

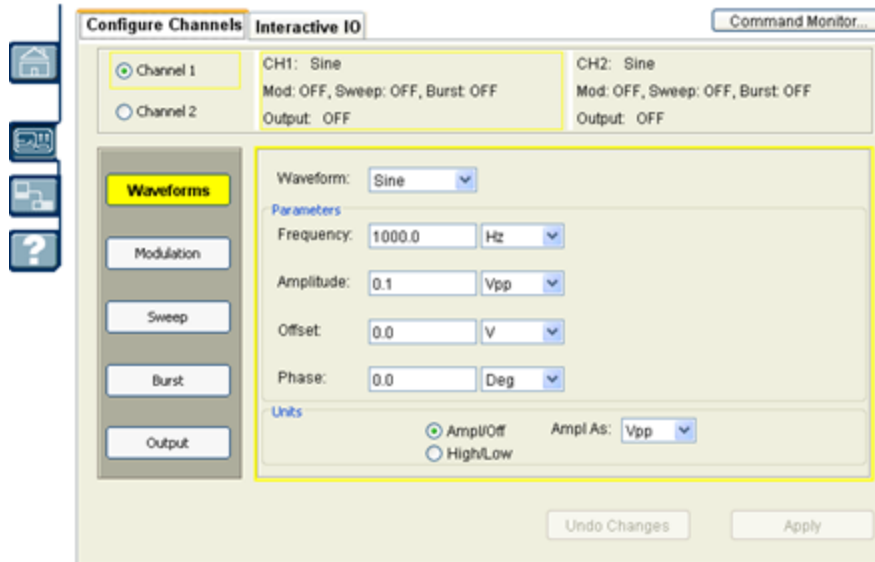

Pour utiliser l'interface Web :

1. Sur votre PC, établissez une connexion à l'instrument sur le réseau local.
2. Ouvrez le navigateur Web sur votre PC.
3. Lancez l'interface Web de l'instrument : entrez l'adresse IP de l'instrument ou le nom d'hôte dans le champ d'adresse du navigateur.
4. Suivez les instructions de l'aide en ligne de l'interface Web.

## Exemples de programmes

La page Web du produit ([www.keysight.com/find/trueform](http://www.keysight.com/find/trueform)) contient de nombreux exemples de programmation. Ces derniers sont des programmes d'applications qui illustrent divers environnements de programmation. Ce document inclut également des **exemples de programmation** pour faciliter la mise en route.

Contacter Keysight Technologies

## Contacter Keysight Technologies



Vous pouvez contacter Keysight Technologies pour les questions de garantie, de maintenance ou d'assistance technique.

Aux États-Unis : (800) 829-4444

En Europe : 31 20 547 2111

Au Japon : 0120-421-345

Pour obtenir les coordonnées internationales d'Keysight ou contacter votre représentant Keysight Technologies, rendez-vous sur [www.keysight.com/find/assist](http://www.keysight.com/find/assist).

© Keysight Technologies, Inc. 2013 - 2015

**Edition 3**

**September, 2015**

# Consignes d'utilisation

Présentation de l'instrument

Mise en route

Utilisation des menus de la face avant

Aide-mémoire des menus de la face avant

Configuration du réseau local

Configuration d'un signal arbitraire

Caractéristiques et fonctions

Didacticiel de génération de signaux

## Présentation de l'instrument

La gamme Keysight Technologies série Trueform comprend des générateurs de signaux synthétisés dotés de fonctions prédéfinies de signaux et impulsions arbitraires.

Présentation succincte de l'instrument

Présentation succincte de la face avant

Présentation succincte de l'écran de la face avant

Saisie d'une valeur numérique sur la face avant

Présentation succincte de la face arrière

## Présentation succincte de l'instrument

L'association de fonctionnalités de paillasse et d'intégration en système constitue une solution polyvalente répondant aux exigences présentes et futures.

### Fonctionnalités d'applications de paillasse

- 16 signaux standard
- Fonctionnalité de signal arbitraire intégré 16 bits (série 33500) ou 14 bits (série 33600)
- Génération de trains d'impulsions précises avec temps de front réglable
- Écran à cristaux liquides (LCD) permettant un affichage numérique et graphique
- Bouton de commande et clavier numérique facile à utiliser
- Enregistrement des états de l'instrument avec noms personnalisés
- Boîtier portable renforcé avec pieds antidérapants
- Sorties isolées pour rompre les boucles de masse

### Fonctions flexibles d'intégration en système

- Mémoire de signaux arbitraires téléchargeable de 1 M.éch (série 33500) ou de 4 M.éch (série 33600). Cette dernière peut être mise à niveau à 16 M.éch (série 33500) ou 64 M.éch (série 33600).
- Interfaces distantes USB, GPIB et LAN (GPIB en option sur certains modèles ; voir [Modèles et options](#) pour de plus amples informations.)
- Conformité à la norme LXI Classe C
- Compatibilité SCPI (Standard Commands for Programmable Instruments)

## Présentation succincte de la face avant

**AVERTISSEMENT**

Les connecteurs BNC (boîtier et broche centrale) situés sur la face avant de l'instrument sont isolés jusqu'à  $\pm 42$  V crête du châssis. Les boîtiers de ces connecteurs BNC sont connectés les uns aux autres et la circuiterie interne tentera de maintenir la tension isolée dans les limites de  $\pm 42$  V crête par rapport au châssis. Tout dépassement de la tension d'isolation au-delà de  $\pm 42$  V crête du châssis peut détruire l'instrument et provoquer des risques de blessures graves, voire mortelles.

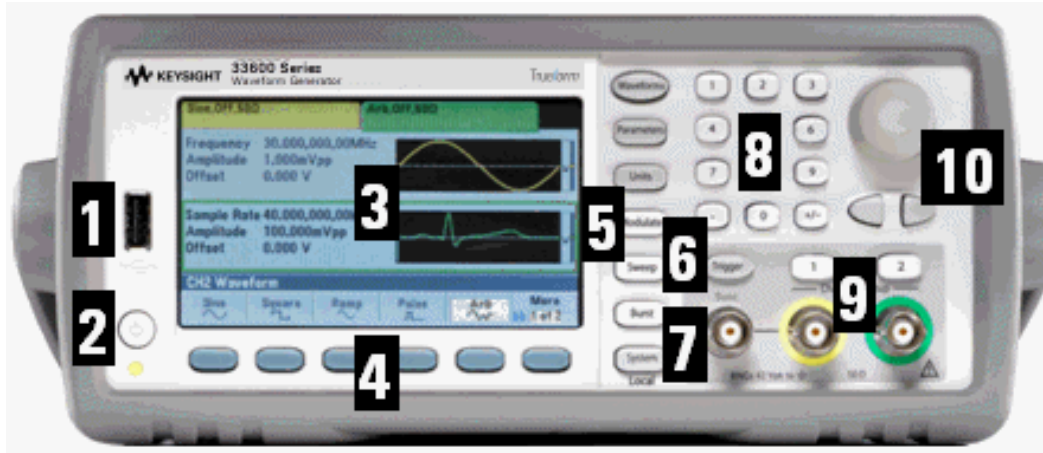

Composant	Description
1	Port USB
2	Interrupteur On/Off (Marche/Arrêt)
3	Écran
4	Touches de fonction
5	Boutons de fonctions intégrées (colonne de sept touches)
6	Bouton de déclenchement manuel
7	Connecteur de synchronisation
8	Clavier numérique
9	Voies 1 et 2 (en fonction du modèle)
10	Bouton et touches fléchées

**REMARQUE**

Maintenez enfoncée n'importe quelle touche de la face avant pour accéder à l'aide contextuelle.

Présentation succincte de l'écran de la face avant

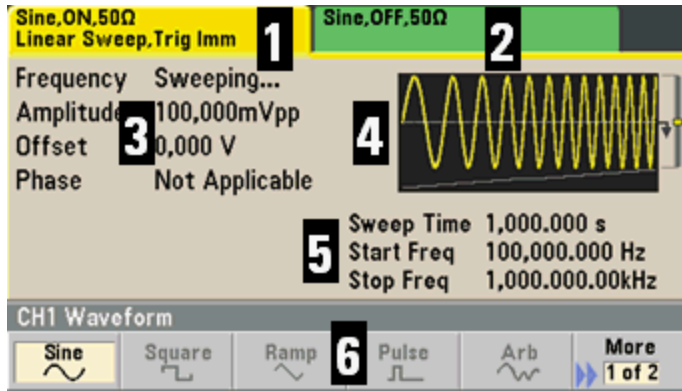

Composant	Description
1	Informations sur la voie 1
2	Informations sur la voie 1 (en fonction du modèle)
3	Paramètres du signal
4	Affichage du signal
5	Paramètres de balayage, de modulation ou de rafale
6	Libellés des touches de fonction

## Saisie d'une valeur numérique sur la face avant

Vous pouvez saisir des nombres sur la face avant en utilisant l'une de ces deux méthodes :

- Utilisez le bouton et les touches fléchées pour modifier le nombre. Tournez le bouton pour modifier un chiffre (dans le sens des aiguilles d'une montre pour l'augmenter). Les flèches sous le bouton déplacent le curseur.



- Utilisez le clavier numérique pour saisir des nombres et les touches de fonction pour sélectionner les unités. La touche [+/-] change le signe du nombre.





Présentation succincte de la face arrière

Les faces arrière des instruments série 33500 et série 33600 comportent des fonctionnalités similaires. Toutefois, leur emplacement varie, comme illustré ci-dessous.

Série 33500



Série 33600



Composant	Description
1	Entrée de référence 10 MHz externe
2	Sortie de référence 10 MHz interne
3	Connecteur GPIB
4	Mise à la terre du châssis
5	Blocage du câble de l'instrument
6	Alimentation CA

Composant	Description
7	Entrée de modulation externe
8	Déclenchement externe/Porte/FSK/Rafale (entrée et sortie)
9	Connecteur d'interface USB
10	Connecteur de réseau local (LAN)

**AVERTISSEMENT** Le connecteur BNC d'entrée de référence 10 MHz situé sur la face arrière de l'instrument est isolé jusqu'à  $\pm 42$  V crête du châssis. Le boîtier de ce connecteur BNC est isolé du reste de l'instrument. La circuiterie interne tentera de maintenir la tension isolée dans les limites de  $\pm 42$  V crête par rapport au châssis. Toute tentative de configuration de cette entrée au-delà de  $\pm 42$  V crête du châssis peut détruire l'instrument et provoquer des risques de blessures graves, voire mortelles.

**AVERTISSEMENT** Le connecteur BNC d'entrée de modulation externe (boîtier et broche centrale) situé sur la face arrière de l'instrument est isolé jusqu'à  $\pm 42$  V crête du châssis. Le boîtier de ce connecteur BNC est relié aux boîtiers des connecteurs BNC de la face arrière. La circuiterie interne tentera de maintenir la tension isolée dans les limites de  $\pm 42$  V crête par rapport au châssis. Toute tentative de configuration des tensions de sortie flottantes au-delà de  $\pm 42$  V crête du châssis peut détruire l'instrument et provoquer des risques de blessures graves, voire mortelles.

**AVERTISSEMENT** Ceci est un équipement de protection de classe 1 (le châssis doit être connecté à une prise de terre). La prise principale doit être insérée uniquement dans une prise munie d'une borne de terre de protection.

## Mise en route

Cette section décrit les procédures de base pour vous aider à utiliser rapidement l'instrument.

- Préparation de l'instrument
- Réglage de la poignée de transport
- Réglage de la fréquence de sortie
- Réglage de l'amplitude de sortie
- Réglage de la tension CC résiduelle
- Définition des valeurs haute et basse
- Envoi d'une tension continue
- Réglage du rapport cyclique d'un signal carré
- Configuration d'un train d'impulsions
- Sélection d'un signal arbitraire prédéfini

## Consignes d'utilisation

- Utilisation de l'aide intégrée
- Montage de l'instrument dans une baie

## Préparation de l'instrument

Vérifiez que vous avez reçu les éléments suivants. S'il manque un de ces éléments, contactez votre agence commerciale Keysight ou votre distributeur agréé Keysight.

- Cordon d'alimentation (adapté au pays)
- Certificat d'étalonnage
- *CD-ROM de référence Keysight série Trueform* (logiciel du produit, exemples de programmation et manuels)
- *CD-ROM Keysight IO Libraries Suite*
- Câble USB 2.0

Remarque : toute la documentation produit est disponible sur le *CD-ROM de référence Keysight série Trueform*. Pour obtenir le dernier microprogramme et la dernière documentation, rendez-vous sur [www.keysight.com/find/trueform](http://www.keysight.com/find/trueform).

L'instrument peut être utilisé avec une alimentation secteur de 100-240 V, 50/60 Hz ou 100-120 V, 400 Hz. La consommation électrique maximale est de 150 VA. Les fluctuations de la tension d'alimentation du réseau principal ne doivent pas dépasser  $\pm 10\%$  de la principale tension nominale. Assurez-vous d'utiliser le cordon d'alimentation secteur d'une puissance adéquate conformément aux caractéristiques nominales de l'instrument et aux codes électriques de votre pays. Branchez le cordon d'alimentation et le câble de réseau local (LAN), GPIB ou USB selon les besoins. Appuyez sur l'interrupteur d'alimentation dans l'angle inférieur gauche de la face avant pour mettre l'instrument sous tension. L'instrument effectue un autotest à la mise sous tension, puis affiche ensuite un message qui explique comment obtenir de l'aide et indique l'adresse IP actuelle. Il affiche également l'adresse GPIB si l'option GPIB est installée et activée.

Interrupteur d'alimentation :



La fonction par défaut de l'instrument est un signal sinusoïdal de 1 kHz / 100 mVpp (dans une terminaison de 50  $\Omega$ ). À la mise sous tension, les connecteurs de sortie des voies sont désactivés. Pour activer la sortie sur le connecteur d'une voie, appuyez sur la touche au-dessus du connecteur et appuyez sur la touche de fonction **Output Off / On**.

Si l'instrument ne s'allume pas, vérifiez que le cordon d'alimentation est solidement branché. Vérifiez également que l'instrument est connecté à une source d'alimentation sous tension. Si le voyant situé sous l'interrupteur d'alimentation est éteint, la tension secteur est absente. Si le voyant est orange, l'instrument est alimenté en courant secteur et en veille ; s'il est vert, l'instrument est en service.

Si le test échoue à la mise sous tension, l'écran affiche **ERR** dans l'angle supérieur droit. Il affiche également « **Check for error messages in the error queue** ».

## Consignes d'utilisation

Pour de plus amples informations sur les codes d'erreur, reportez-vous à la section [Messages d'erreur SCPI](#). Pour des instructions détaillées sur le retour de l'instrument pour entretien, reportez-vous à la section [Présentation des opérations d'entretien et de réparation](#).

Pour mettre l'instrument hors tension, maintenez l'interrupteur d'alimentation enfoncé pendant environ 500 ms. Cela évite d'éteindre l'instrument en appuyant accidentellement sur l'interrupteur.

## Réglage de la poignée de transport

Saisissez les bords de la poignée, tirez vers l'extérieur et tournez la poignée.

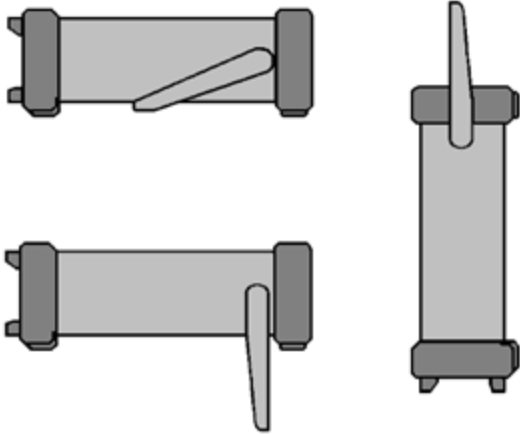

### Réglage de la fréquence de sortie

La fréquence par défaut est de 1 kHz. Vous pouvez modifier cette fréquence et la spécifier en nombre de périodes au lieu de Hz.

Pour modifier la fréquence à l'aide du bouton :

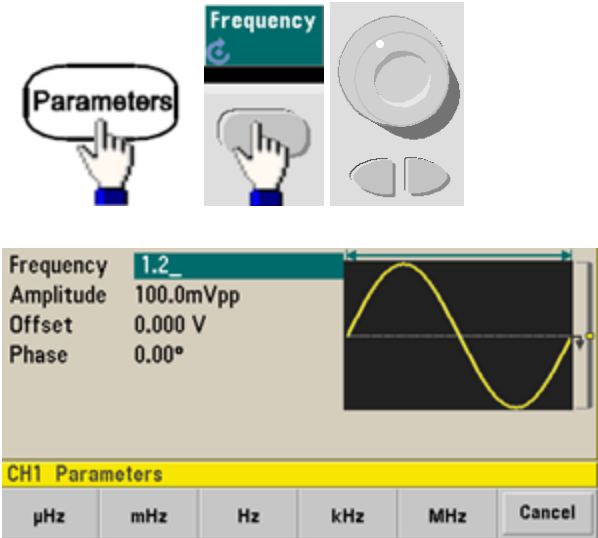

Pour modifier la fréquence avec le clavier numérique :



Terminez en sélectionnant l'unité de fréquence :



Pour changer l'unité en nombre de périodes au lieu de la fréquence :

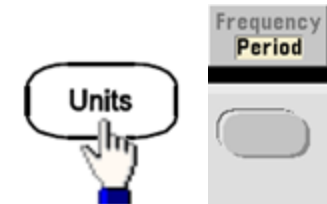

## Réglage de l'amplitude de sortie

La fonction par défaut de l'instrument est un signal sinusoïdal de 1 kHz / 100 mVpp (dans une terminaison de 50 Ω).

Les opérations suivantes modifient l'amplitude avec 50 mVpp.

1. Appuyez sur **[Units]** > **Amp/Offs** ou **High/Low** pour vous assurer que vous êtes sur **Amp/Offs**.

L'amplitude affichée est la valeur de mise sous tension ou la valeur sélectionnée précédemment. Lorsque vous changez de fonction, la même amplitude est utilisée si elle est valide pour la nouvelle fonction. Pour déterminer si la tension doit être spécifiée en amplitude et tension résiduelle ou en valeurs supérieure et inférieure, appuyez sur **[Units]**, puis sur la deuxième touche de fonction. Dans ce cas, nous mettons en surbrillance **Amp/Offs**.

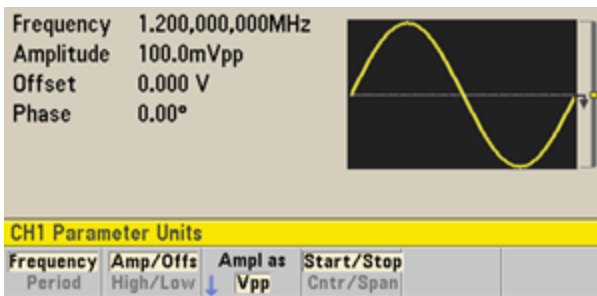

2. Entrez la valeur de l'amplitude désirée.

Appuyez sur **[Parameters]** > **Amplitude**. À l'aide du pavé numérique, saisissez la valeur 50.

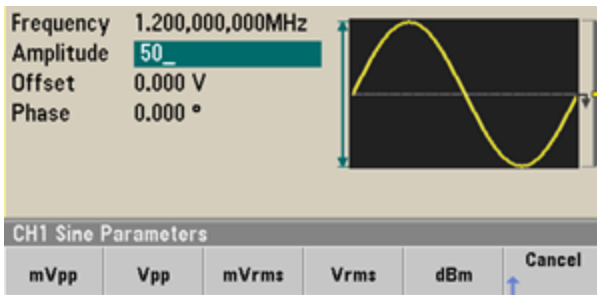

### 3. Sélectionnez les unités souhaitées.

Pour cela, appuyez sur la touche de fonction correspondant à l'unité désirée. Lorsque vous sélectionnez les unités, l'instrument envoie le signal avec l'amplitude affichée (si la sortie est activée). Dans cet exemple, appuyez sur **mVpp**.

Vous pouvez également saisir la valeur désirée à l'aide du bouton et des flèches. Si vous procédez ainsi, vous n'avez pas besoin d'utiliser la touche de fonction des unités. Vous pouvez convertir facilement les types d'unité. Il suffit d'appuyer sur **[Units] > Ampl As** et sélectionnez les unités souhaitées.

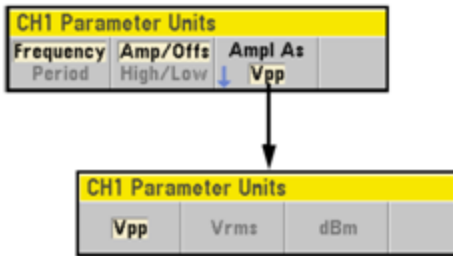



## Réglage de la tension CC résiduelle

À la mise sous tension, la tension CC résiduelle est nulle (0 V). Les opérations suivantes modifient la tension résiduelle avec -1,5 Vcc.

1. Appuyez sur **[Parameters]** > **Offset**.

La tension résiduelle affichée est la valeur de mise sous tension ou la valeur sélectionnée précédemment. Lorsque vous changez de fonction, la même tension est utilisée si la valeur présente est valide pour la nouvelle fonction.

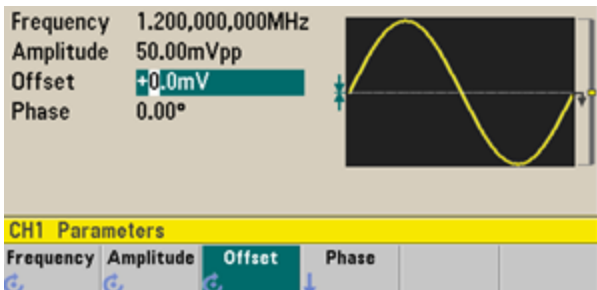

2. Entrez la tension résiduelle désirée.

Dans ce cas, nous utiliserons le clavier numérique pour saisir -1,5.

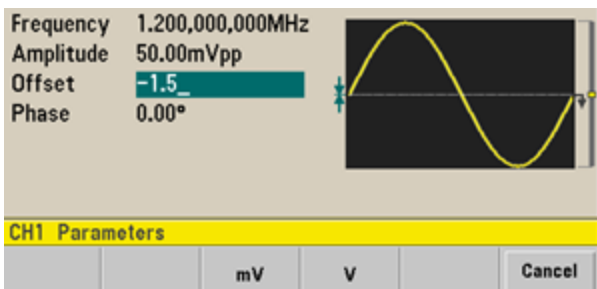

3. Sélectionnez les unités souhaitées.

Appuyez sur la touche de fonction correspondant aux unités souhaitées. Lorsque vous sélectionnez les unités, l'instrument envoie le signal avec la tension résiduelle affichée (si la sortie est activée). Dans cet exemple, appuyez sur **V**. La tension est définie, comme illustré ci-dessous.

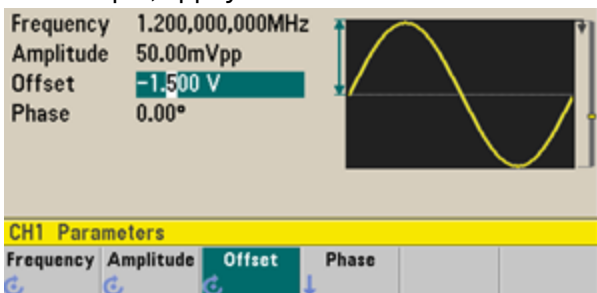

Vous pouvez également saisir la valeur désirée à l'aide du bouton et des flèches.

## Définition des valeurs haute et basse

Vous pouvez spécifier un signal en indiquant son amplitude et sa tension CC résiduelle (voir ci-dessus). Vous pouvez également spécifier le signal avec des valeurs haute (maximum) et basse (minimum). Cela est particulièrement intéressant pour les applications numériques. Dans l'exemple suivant, nous réglons le niveau haut à 1,0 V et le niveau bas à 0,0 V.

1. Appuyez sur **[Units]** > **Ampl/Offs** pour basculer vers **High/Low** comme indiqué ci-dessous.

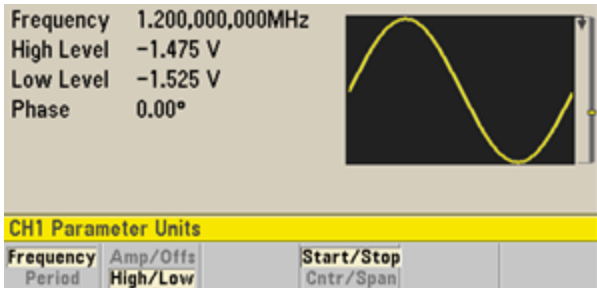

2. Appuyez sur **[Parameters]** > **High Level**. À l'aide du clavier numérique ou du bouton et des flèches, sélectionnez 1,0 V. (Si vous utilisez le clavier, vous devez sélectionner la touche de fonction de l'unité **V** pour saisir la valeur).

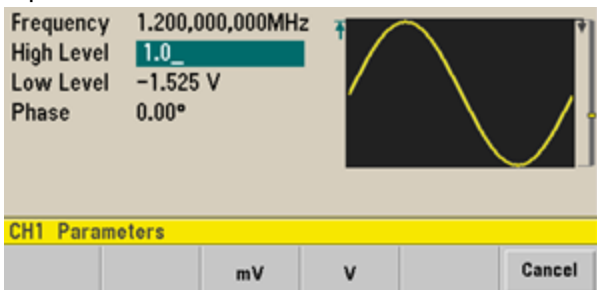

3. Appuyez sur la touche de fonction **Low Level** et définissez la valeur. Utilisez à nouveau le pavé numérique ou le bouton rotatif pour saisir la valeur 0,0 V.

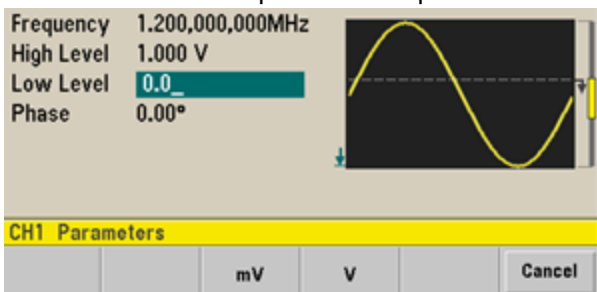

Ces réglages (niveau haut = 1,0 V et niveau bas = 0,0 V) sont équivalents à un réglage d'amplitude de 1,0 Vpp et de tension résiduelle de 500 mVcc.

## Envoi d'une tension continue

Vous pouvez envoyer une tension CC constante comprise entre -5 V et +5 V dans une résistance de 50  $\Omega$ , ou entre -10 V et +10 V dans une charge de haute impédance.

1. Appuyez sur **[Waveforms] > More > DC**.

La valeur **Offset** est sélectionnée.

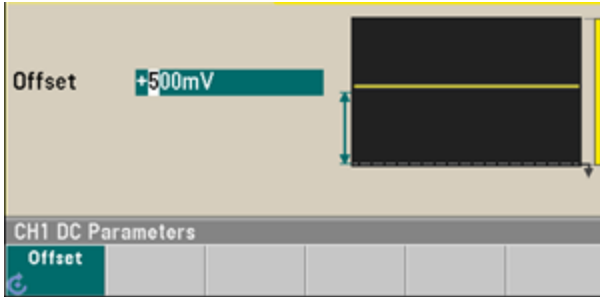

2. **Entrez la tension résiduelle souhaitée.**

Entrez 1,0 à l'aide du clavier numérique ou du bouton et appuyez sur la touche de fonction **V** si vous utilisez le clavier.

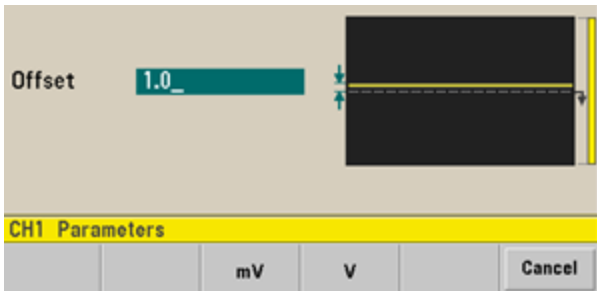

## Réglage du rapport cyclique d'un signal carré

À la mise sous tension, le rapport cyclique par défaut d'un signal carré est de 50 %. Le rapport cyclique est limité par la largeur minimale des impulsions spécifiée de 16 ns sur la série 33500, ou de 5 ns jusqu'à 4 Vpp et 8 ns jusqu'à 10 Vpp sur la série 33600. La procédure suivante modifie le rapport cyclique avec la valeur 75 %.

### 1. Sélectionnez la fonction de signal carré.

Appuyez sur **[Waveforms] > Square**.

### 2. Appuyez sur la touche de fonction **Duty Cycle**.

Le rapport cyclique affiché est la valeur de mise sous tension ou le pourcentage sélectionné précédemment. Le rapport cyclique représente la durée par cycle pendant laquelle le signal carré est à un niveau élevé.

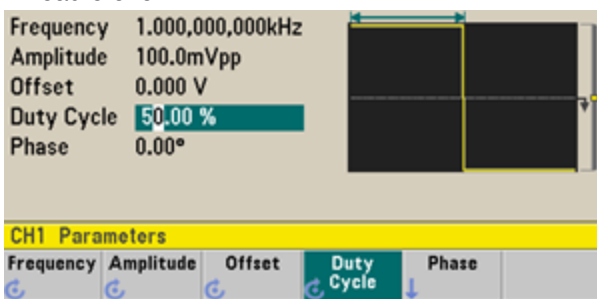

### 3. Saisissez le rapport cyclique souhaité.

Sur le clavier numérique ou à l'aide du bouton et des flèches, sélectionnez un rapport cyclique de 75. Si vous utilisez le clavier numérique, appuyez sur **Percent** pour terminer la saisie. L'instrument règle immédiatement le rapport cyclique et délivre un signal carré ayant la valeur mentionnée (si la sortie est activée).

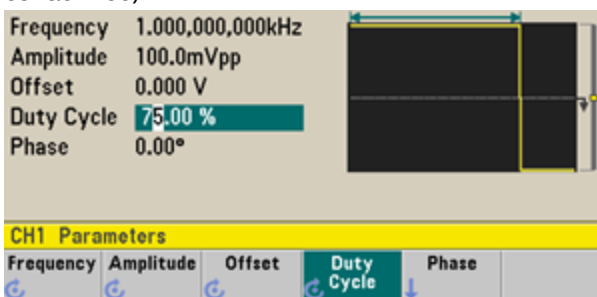

## Configuration d'un train d'impulsions

Vous pouvez configurer l'instrument pour envoyer un train d'impulsions avec une largeur d'impulsion et un temps de front variables. Les opérations suivantes expliquent comment configurer un train d'impulsions de période 500 ms avec une largeur d'impulsion de 10 ms et des temps de front de 50 ns.

**1. Sélectionnez la fonction d'impulsion.**

Appuyez sur **[Waveforms]** > **Pulse** pour sélectionner la fonction d'impulsion.

**2. Définissez la période d'impulsion.**

Appuyez sur la touche **[Units]**, puis appuyez sur **Frequency/Period** pour choisir **Period**. Appuyez ensuite sur **[Parameters]** > **Period**. Définissez la période à 500 ms.

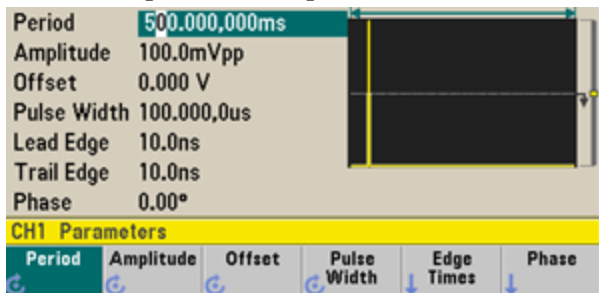

**3. Définissez la largeur d'impulsion.**

Appuyez sur **[Parameters]** > **Pulse Width**. Définissez ensuite la largeur d'impulsion à 10 ms. La largeur d'impulsion représente la durée entre 50 % du front montant et 50 % du front descendant suivant.

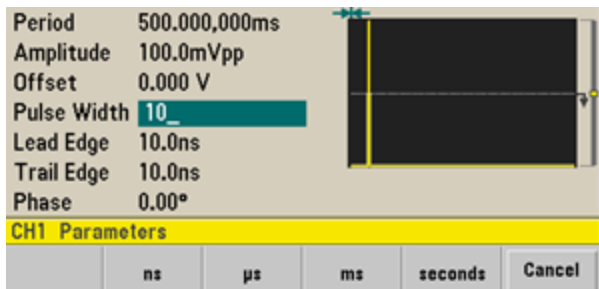

**4. Réglez le temps des deux fronts.**

Appuyez sur la touche de fonction **Edge Times**, puis définissez la durée des fronts montant et descendant à 50 ns. Le temps de front représente la durée entre 10 et 90 % de chaque front.

## Sélection d'un signal arbitraire prédéfini

Il existe neuf signaux arbitraires prédéfinis enregistrés en mémoire non volatile : Cardiaque, D-Lorentz, Décroissance exponentielle, Croissance exponentielle, Gaussien, Demi-sinus inverse (Haversine), Lorentz, Rampe négative et Sinc.

Cette procédure sélectionne le signal prédéfini « décroissance exponentielle » sur la face avant. Pour plus d'informations sur la création d'un signal arbitraire personnalisé, reportez-vous à la section [Configuration d'un signal arbitraire](#).

1. Appuyez sur **[Waveforms]** > **Arb** > **Arbs**.
2. Choisissez **Select Arb** et sélectionnez **Exp\_Fall** à l'aide du bouton. Appuyez sur **Select**.

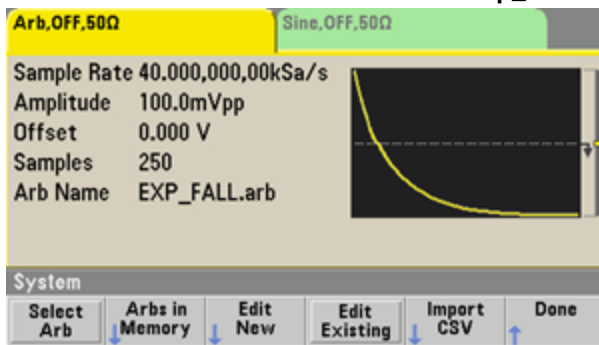

## Utilisation de l'aide intégrée

Le système d'aide intégré fournit une aide contextuelle sur toutes les touches de la face avant et les touches de fonction des menus. La liste des rubriques d'aide est également disponible pour vous aider dans les diverses opérations sur la face avant.

### Affichage de l'aide sur la fonction d'une touche

Appuyez sur une touche de fonction ou une touche de la face avant, telle que **[Waveforms]**. Si le message contient plus d'informations que ne peut en afficher l'écran, appuyez sur la flèche vers le bas ou tournez le bouton dans le sens des aiguilles d'une montre pour afficher les informations restantes.

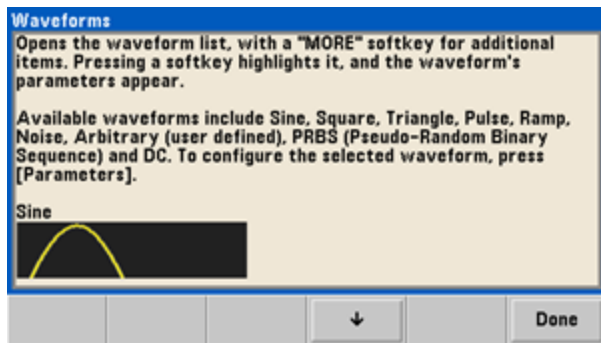

Appuyez sur **Done** pour quitter l'aide.

### Affichage de la liste des rubriques d'aide.

Appuyez sur **[System] > Help** pour afficher la liste des rubriques d'aide. Pour faire défiler la liste, appuyez sur les flèches vers le haut et vers le bas ou utilisez le bouton. Sélectionnez la rubrique **Get HELP on any key**, puis appuyez sur **Select**. Notez que les rubriques peuvent différer de la liste illustrée ci-dessous, selon le modèle et la version du microprogramme.

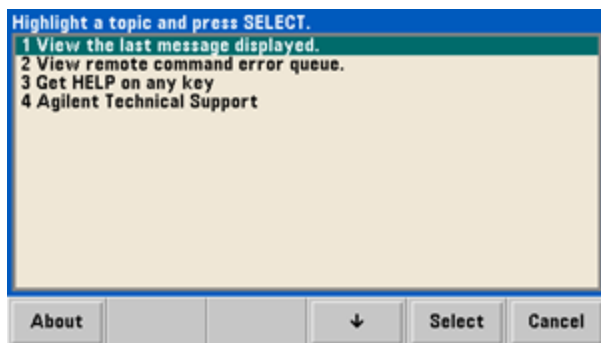

Appuyez sur **Done** pour quitter l'aide.

### Affichage des informations d'aide sur les messages affichés.

Lorsqu'une limite est dépassée ou qu'une autre configuration incorrecte est détectée, l'instrument affiche un message. Le système d'aide intégré fournit des informations supplémentaires sur le message le plus récent. Appuyez sur **[System] > Help**. Sélectionnez ensuite la rubrique **View the last message displayed**, et appuyez sur **Select**.

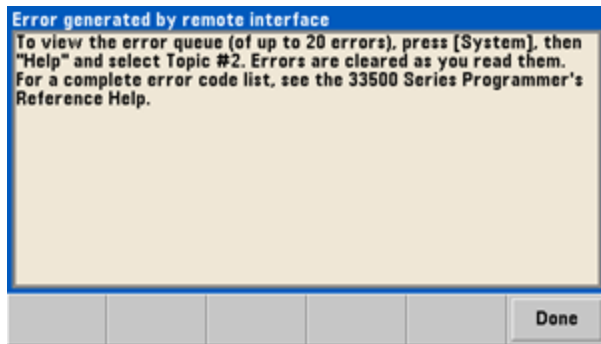

Appuyez sur **Done** pour quitter l'aide.

#### **REMARQUE** Aide dans votre langue

Tous les messages, l'aide contextuelle et les rubriques d'aide existent dans les langues suivantes : Anglais, Chinois, Français, Allemand, Japonais, Coréen et Russe. Les libellés des touches de fonction des menus et les messages des lignes d'état ne sont pas traduits. Pour sélectionner la langue, appuyez sur **[System] > System Setup > User Settings > Help Lang**. Sélectionnez ensuite la langue désirée.



## Montage de l'instrument dans une baie

Vous pouvez installer l'instrument dans une armoire standard 19 pouces à l'aide d'un des trois kits disponibles en option fournis chacun avec des instructions et le matériel nécessaire au montage. Tout instrument Keysight System II de mêmes dimensions peut s'installer dans une baie à côté de l'instrument.

**REMARQUE** Avant de monter l'instrument dans une baie, démontez la poignée de transport et les plots en caoutchouc à l'avant et à l'arrière.

**Pour démonter la poignée, tournez-la à la verticale et tirez les extrémités vers l'extérieur.**

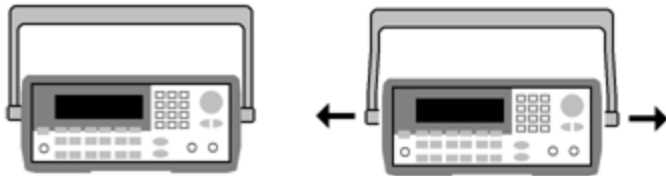

**Pour retirer la ceinture antichoc en caoutchouc, étirez un coin et faites-la glisser.**

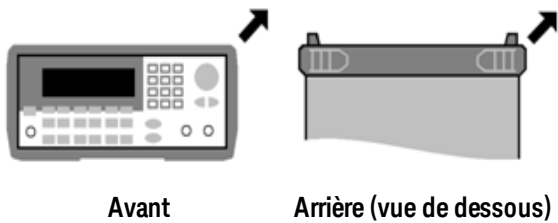

**Pour monter un seul instrument dans une baie, commandez le kit de montage 1CM124A.**

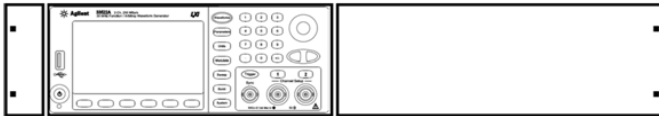

**Pour monter deux instruments côte-à-côte dans une baie, commandez le kit de liaison 34194A et la cornière 1CM107A. N'oubliez pas d'utiliser les rails de support dans l'armoire de baie.**

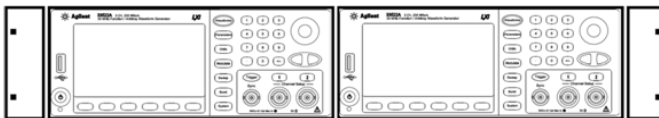

**ATTENTION**

Pour éviter la surchauffe de l'instrument, ne bloquez pas l'écoulement d'air vers sur l'instrument (entrée et sortie). L'air entre à l'arrière de l'instrument et ressort par les deux côtés et la partie inférieure. Assurez-vous qu'au moins l'un de ces côtés n'est pas bloqué afin de permettre une évacuation adéquate de l'air de ventilation. Ne bloquez pas le ventilateur sur la face arrière de l'instrument.

Le ventilateur de l'instrument série 33600 fonctionne à une vitesse constante et une température ambiante de 28 °C. Cette vitesse augmente lorsque la température ambiante dépasse 28 °C.

Les instruments de la série 33600 contrôlent les températures internes critiques et s'éteignent si les limites sont dépassées. Une défaillance de la ventilation peut provoquer un arrêt de l'instrument.

## Utilisation des menus de la face avant

Cette section présente les touches et les menus de la face avant. Pour de plus amples informations sur le fonctionnement de la face avant, reportez-vous aux sections [Caractéristiques et fonctions](#), [Aide-mémoire des menus de la face avant](#), [Procédure de configuration du réseau local](#) et [Configuration d'un signal arbitraire](#).

- [Sélection de l'impédance de sortie](#)
- [Réinitialisation de l'instrument](#)
- [Envoi d'un signal modulé](#)
- [Envoi d'un signal FSK](#)
- [Envoi d'un signal PWM](#)
- [Envoi d'un balayage en fréquence](#)
- [Envoi d'un signal en rafale](#)
- [Déclenchement d'un balayage ou d'une rafale](#)
- [Enregistrement ou récupération de la configuration de l'instrument](#)

## Sélection de l'impédance de sortie

L'instrument comporte un ensemble constant d'impédances de sortie de 50  $\Omega$  sur les connecteurs de la face avant. Si l'impédance de charge réelle diffère de la valeur spécifiée, l'amplitude et les niveaux de décalage affichés seront incorrects. Le réglage de l'impédance de la charge est simplement un moyen pratique de garantir que la tension affichée correspond à la charge attendue.

1. Appuyez sur la touche de sortie d'une voie pour accéder à l'écran de configuration des voies. Notez que les valeurs d'impédance de sortie (toutes deux de 50  $\Omega$  dans ce cas) apparaissent dans les onglets en haut de l'écran.
2. Commencez par spécifier l'impédance de sortie en appuyant sur **Output Load**.

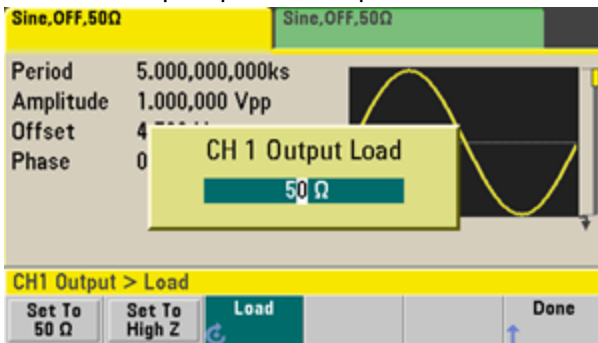

3. Sélectionnez l'impédance de charge de sortie souhaitée à l'aide du bouton ou du clavier numérique, ou appuyez sur **Set to 50  $\Omega$**  ou sur **Set to High Z**.

## Réinitialisation de l'instrument

Pour réinitialiser l'instrument à son **état par défaut à la sortie d'usine**, appuyez sur **[System] > Set to Defaults > Yes**.

## Envoi d'un signal modulé

Un signal modulé se compose d'un signal porteur et d'un signal modulant. En modulation d'amplitude (AM), le signal modulant fait varier l'amplitude du signal porteur. Dans cet exemple, vous envoyez un signal à modulation d'amplitude avec une profondeur de modulation de 80 %. Le signal porteur est un signal sinusoïdal de 5 kHz ; le signal modulant est un signal sinusoïdal de 200 Hz.

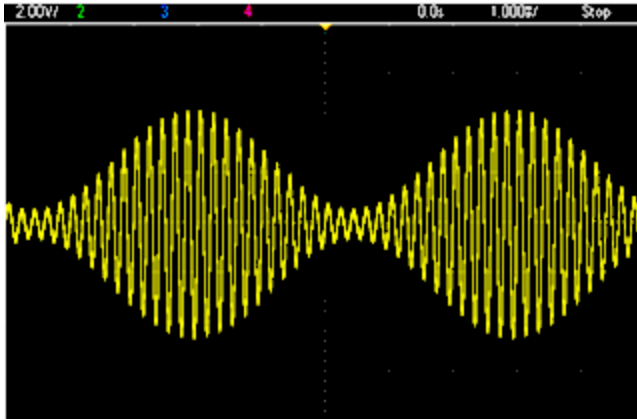

### 1. Sélectionnez la fonction, la fréquence et l'amplitude du signal porteur.

Appuyez sur la touche **[Waveforms]** > **Sine**. Appuyez sur les touches de fonction **Frequency**, **Amplitude** et **Offset** pour configurer le signal porteur. Pour cet exemple, sélectionnez un signal sinusoïdal de 5 kHz d'amplitude 5 Vpp avec une tension résiduelle nulle (0 V).

Notez que vous pouvez spécifier l'amplitude en Vpp, Veff ou dBm.

### 2. Sélectionnez AM.

Appuyez sur **[Modulate]**, puis sélectionnez **AM** à l'aide de la touche de fonction **Type**. Appuyez ensuite sur la touche de fonction **Modulate** pour activer la modulation. Notez que la touche **[Modulate]** s'allume et que le message d'état « AM Modulated by Sine » s'affiche dans la partie supérieure gauche de l'écran.

### 3. Définissez la profondeur de modulation.

Appuyez sur la touche de fonction **AM Depth**, puis définissez la valeur à 80 % à l'aide du clavier numérique ou du bouton et des flèches.

### 4. Sélectionnez la forme du signal modulant.

Appuyez sur la touche **Shape** pour sélectionner la forme du signal modulant. Pour cet exemple, sélectionnez un signal sinusoïdal.

### 5. Appuyez sur AM Freq.

Sur l'instrument série 33500, vous devez d'abord appuyer sur la touche de fonction **More** pour accéder au menu approprié. Affectez 200 Hz à cette valeur à l'aide du clavier numérique, ou du bouton et des flèches. Appuyez sur **Hz** pour terminer la saisie si vous utilisez le clavier numérique.

## Envoi d'un signal FSK

Vous pouvez configurer l'instrument pour « faire dériver » sa fréquence de sortie entre deux valeurs prédéfinies (appelées « fréquence porteuse » et « fréquence de saut ») à l'aide de la commande **FSK modulation**. La vitesse de dérive de la sortie entre ces deux fréquences est déterminée par le générateur de fréquences interne ou le niveau de signal sur le connecteur **Ext Trig** de la face arrière. Dans cet exemple, vous réglez la fréquence du signal porteur sur 3 kHz et la fréquence secondaire (fréquence de saut) sur 500 Hz, avec une vitesse FSK de 100 Hz.

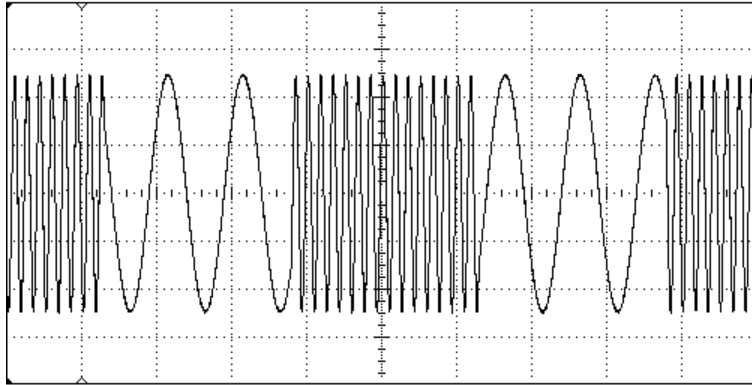

### 1. Sélectionnez la fonction, la fréquence et l'amplitude du signal porteur.

Appuyez sur la touche **[Waveforms]** > **Sine**. Appuyez sur les touches de fonction **Frequency**, **Amplitude** et **Offset** pour configurer le signal porteur. Pour cet exemple, sélectionnez un signal sinusoïdal de 5 kHz d'amplitude 5 Vpp avec une tension résiduelle nulle (0 V).

### 2. Sélectionnez FSK.

Appuyez sur **[Modulate]**, puis sélectionnez FSK à l'aide de la touche de fonction **Type**. Appuyez ensuite sur la touche de fonction **Modulate** pour activer la modulation. Notez l'affichage du message d'état « FSK Modulated » dans la partie gauche supérieure de l'écran.

### 3. Réglez la fréquence de saut.

Appuyez sur la touche de fonction **Hop Freq**, puis définissez la valeur de 500 Hz à l'aide du clavier numérique, ou du bouton et des flèches. Si vous utilisez le clavier numérique, n'oubliez pas de terminer la saisie en appuyant sur **Hz**.



### 4. Définissez la vitesse de montée FSK.

Appuyez sur la touche de fonction **FSK Rate**, puis définissez la valeur 100 Hz à l'aide du clavier numérique, ou du bouton et des flèches.



L'instrument envoie alors un signal FSK si la sortie de la voie est activée.

## Envoi d'un signal PWM

Vous pouvez configurer l'instrument pour envoyer un signal PWM (modulation de la largeur d'impulsion). La modulation PWM est disponible uniquement pour un train d'impulsions ; la largeur d'impulsion varie en fonction du signal modulant. L'importance de variation d'une largeur d'impulsion est appelée variation de largeur ; elle peut être spécifiée en pourcentage de la période du signal (rapport cyclique) ou en unité de temps. Par exemple, si vous spécifiez une impulsion avec un rapport cyclique de 20 % et activez ensuite la modulation PWM avec une variation de 5 %, le rapport cyclique varie entre 15 % et 25 % sous le contrôle du signal modulant.

Pour modifier la largeur d'impulsion en rapport cyclique d'impulsion, appuyez sur **[Units]**.

Dans cet exemple, vous spécifiez une largeur d'impulsion et une variation de la largeur d'impulsion pour un train d'impulsions de 1 kHz avec un signal modulant sinusoïdal de 5-Hz.

### 1. Sélectionnez les paramètres du signal porteur.

Appuyez sur **[Waveforms]** > **Pulse**. Utilisez les touches de fonction **Frequency**, **Amplitude**, **Offset**, **Pulse Width** et **Edge Times** pour configurer le signal porteur. Dans cet exemple, sélectionnez un train d'impulsions de 1 kHz avec une amplitude de 1 Vpp, un décalage nul, une largeur d'impulsion de 100 µs et un temps de front (montant et descendant) de 50 ns.



### 2. Sélectionnez PWM.

Appuyez sur **[Modulate]** > **Type** > **PWM**. Appuyez ensuite sur la première touche de fonction (**Modulate**) pour activer la modulation. Notez l'affichage du message d'état « PWM Modulated by Sine » dans l'angle supérieur gauche de l'écran.

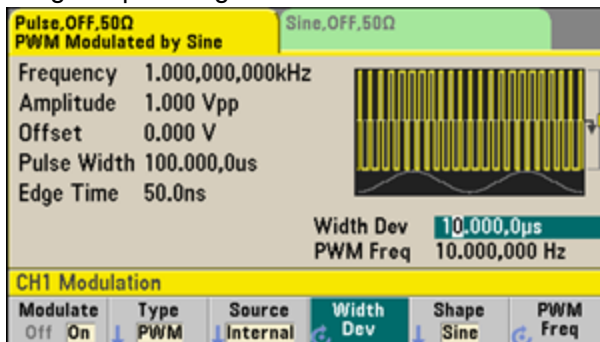

### 3. Définissez la variation de la largeur.

Appuyez sur la touche de fonction **Width Dev**, puis définissez la valeur à 20  $\mu$ s à l'aide du clavier numérique, ou du bouton et des flèches.



### 4. Définissez la fréquence de modulation.

Appuyez sur la touche de fonction **PWM Freq**, puis définissez la valeur à 5 Hz à l'aide du clavier numérique, ou du bouton et des flèches.



### 5. Sélectionnez la forme du signal modulant.

Appuyez sur la touche **Shape** pour sélectionner la forme du signal modulant. Pour cet exemple, sélectionnez un signal sinusoïdal.

Pour afficher le signal PWM réel, vous devez l'envoyer à un oscilloscope. Si vous effectuez cette action, vous constaterez la variation de la largeur d'impulsion, dans ce cas entre 80 et 120  $\mu$ s. Avec une fréquence de modulation de 5 Hz, la variation est très visible.



## Envoi d'un balayage en fréquence

En mode balayage de fréquence, l'instrument passe de la fréquence initiale à la fréquence finale à une vitesse de balayage que vous spécifiez. Vous pouvez effectuer un balayage en fréquence croissant ou décroissant, et linéairement ou selon une loi logarithmique, ou utiliser une liste de fréquences. Dans cet exemple, vous envoyez un signal sinusoïdal balayé compris entre 50 Hz et 5 kHz.

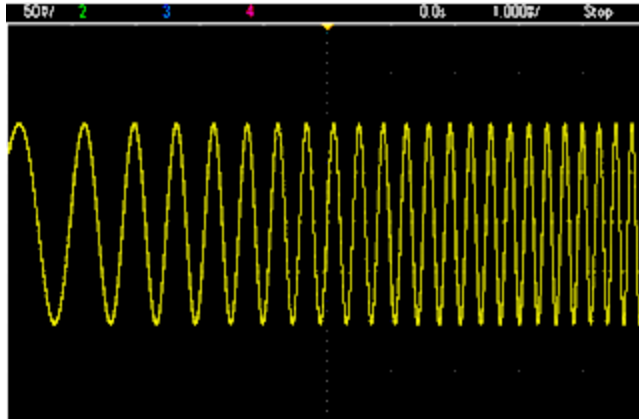

### 1. Sélectionnez la fonction et l'amplitude du balayage.

Pour les balayages, vous pouvez sélectionner des signaux sinusoïdaux, carrés, triangulaires, PRBS, arbitraires ou des rampes et des impulsions (le bruit et le courant continu ne sont pas autorisés). Dans cet exemple, sélectionnez un signal sinusoïdal d'amplitude 5 Vpp.

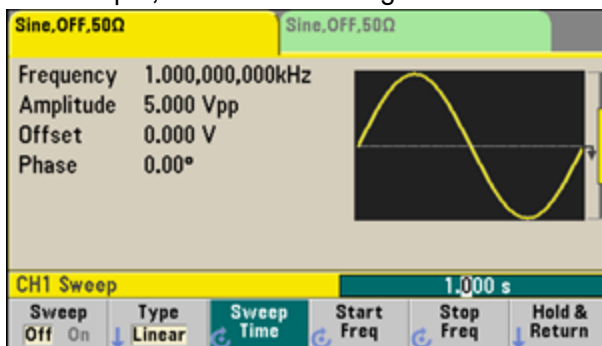

### 2. Sélectionnez le mode de balayage.

Appuyez sur [**Sweep**] et vérifiez que le mode de balayage linéaire est sélectionné à l'aide de la deuxième touche de fonction. Appuyez sur la touche de fonction **Sweep** pour activer le balayage. Notez l'affichage du message d'état **Linear Sweep** en haut de l'onglet de la voie active. Le bouton est également allumé.

### 3. Définissez la fréquence initiale.

Appuyez sur **Start Freq**, puis définissez la valeur à 50 Hz à l'aide du clavier numérique, ou du bouton et des flèches.

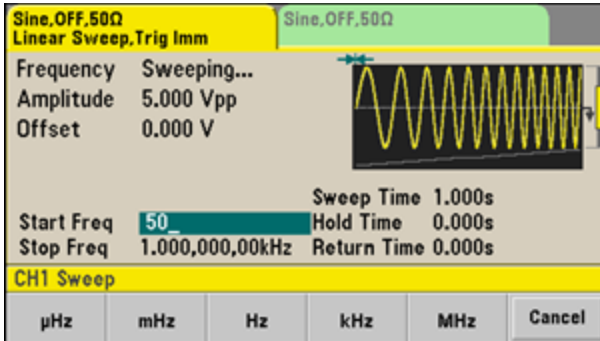

### 4. Définissez la fréquence finale.

Appuyez sur la touche **Stop Freq** et définissez la valeur à 5 Hz à l'aide du clavier numérique, ou du bouton et des flèches.

L'instrument envoie alors un balayage continu de 50 Hz à 5 kHz si la sortie est activée.

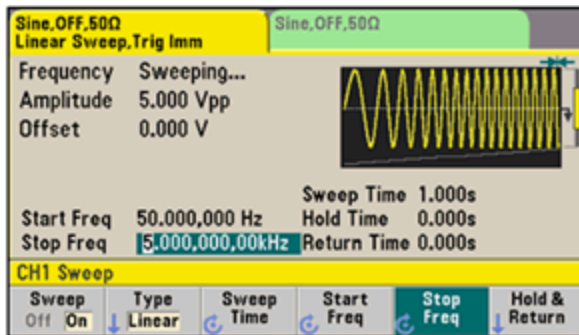

Vous pouvez également configurer les limites de la fréquence de balayage en utilisant une fréquence médiane et une plage de fréquences. Ces paramètres similaires aux fréquences initiale et finale (ci-dessus) offrent une plus grande souplesse. Pour obtenir les mêmes résultats, réglez la fréquence médiane sur 2,525 kHz et l'étendue de la fréquence sur 4,950 kHz.

CH1 Parameter Units			
Frequency	Amp/Offs	Ampl As	Start/Stop
Period	High/Low	Vpp	Cntr/Span

Pour générer une fréquence de balayage, appuyez deux fois sur **[Trigger]**. La première pression place le déclenchement en mode manuel ; la deuxième envoie un déclenchement. Pour plus d'informations, reportez-vous à la section **Déclenchement d'un balayage ou d'une rafale**.

## Envoi d'un signal en rafale

Vous pouvez configurer l'instrument afin d'émettre un signal sur un nombre déterminé de cycles, appelé rafale. Vous pouvez contrôler la durée écoulée entre des salves au moyen de l'horloge interne ou du niveau du signal sur le connecteur **Ext Trig** de la face arrière. Dans cet exemple, vous envoyez un signal sinusoïdal sur 3 périodes de rafale de 20 ms.

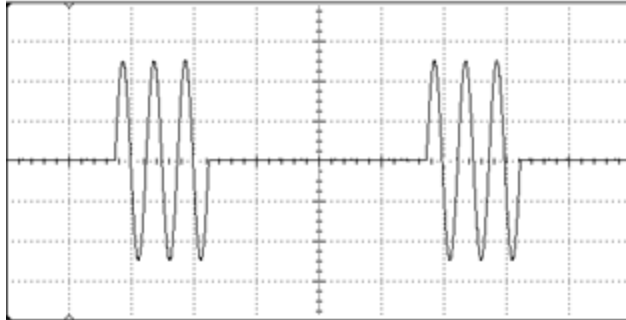

### 1. Sélectionnez la fonction et l'amplitude de la rafale.

Pour des signaux en rafale, vous pouvez sélectionner des signaux sinusoïdaux, carrés, en rampe, triangulaires, des impulsions, arbitraires ou PRBS. Le bruit est autorisé uniquement en mode de rafale « commandée » ; le courant continu n'est pas autorisé. Dans cet exemple, sélectionnez un signal sinusoïdal d'amplitude 5 Vpp.

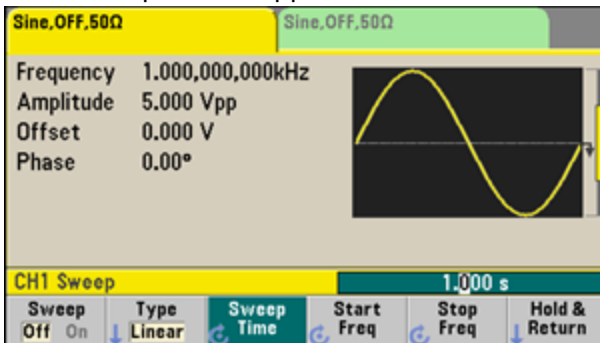

### 2. Sélectionnez le mode rafale.

Appuyez sur [**Burst**] > **Burst Off/On**. Notez l'affichage d'un message d'état **N Cycle Burst, Trig Imm** dans l'onglet de la voie active.

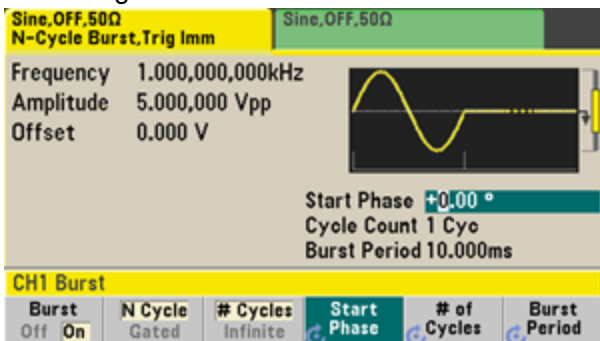

### 3. Définissez le nombre de rafales.

Appuyez sur **# of Cycles** et définissez le nombre à « 3 » à l'aide du clavier numérique ou du bouton. Appuyez sur **Enter** pour terminer la saisie des données si vous utilisez le clavier numérique.

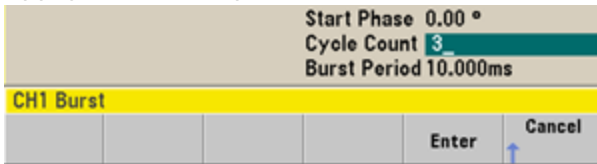

### 4. Définissez la période de rafale.

Appuyez sur **Burst Period** et définissez une période de 20 ms à l'aide du clavier numérique, ou du bouton et des flèches. La période de rafale définit la durée entre le début d'une salve et le début de la suivante. L'instrument envoie alors une rafale continue de 3 salves à intervalles de 20 ms.

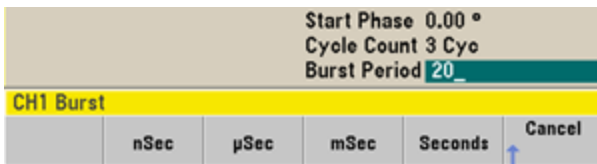

Vous pouvez générer une seule rafale (avec le nombre spécifié de salves) en appuyant sur la touche **[Trigger]**. Pour plus d'informations, reportez-vous à la section **Déclenchement d'un balayage ou d'une rafale**.

Vous pouvez également utiliser le signal de déclenchement externe pour créer des rafales commandées lorsqu'une rafale est produite lorsqu'un signal de commande est présent à l'entrée.

## Déclenchement d'un balayage ou d'une rafale

Vous pouvez sélectionner l'un des quatre types de déclenchement sur la face avant pour les balayages et les rafales :

- Immédiat ou « automatique » (par défaut) : l'instrument émet en permanence lorsque le mode balayage ou rafale est sélectionné.
- Externe : le déclenchement est commandé par le connecteur **Ext Trig** de la face arrière.
- Manuel : déclenche un balayage ou une rafale chaque fois que vous appuyez sur la touche **[Trigger]**. Continuez à appuyer sur **[Trigger]** pour déclencher à nouveau l'instrument.
- Temporisation : envoie un ou plusieurs déclenchements à un intervalle de temps constant.

Si le mode balayage ou rafale est actif, appuyez sur **[Trigger]** pour afficher le menu de déclenchement. La touche allumée **[Trigger]** (en continu ou clignotante) indique qu'une ou deux voies attendent un déclenchement manuel. La touche s'allume en continu si le menu de déclenchement est sélectionné ; elle s'allume par intermittence si le menu de déclenchement n'est pas sélectionné. La touche **[Trigger]** est désactivée lorsque l'instrument est en mode de commande à distance.

Le fait d'appuyer sur la touche **[Trigger]** lorsque celle-ci est allumée en continu provoque un déclenchement manuel. Le fait d'appuyer sur la touche **[Trigger]** lorsqu'elle clignote entraîne l'ouverture du menu de déclenchement ; une deuxième pression sur la touche provoque un déclenchement manuel.

## Enregistrement ou récupération de la configuration de l'instrument

Vous pouvez enregistrer les configurations de l'instrument dans n'importe quel nombre de fichiers de configuration (extension .sta). Cela est utile à des fins de sauvegarde. Vous pouvez également enregistrer la configuration sur une clé USB et la charger dans un autre instrument pour obtenir des instruments dotés de configurations identiques. Une configuration enregistrée contient la fonction, la fréquence, l'amplitude, la tension CC résiduelle, le rapport cyclique, la symétrie et tous les paramètres de modulation ou de rafale utilisés. L'instrument n'enregistre pas les signaux arbitraires volatiles.

1. Sélectionnez l'emplacement d'enregistrement désiré.



- Appuyez sur **Name** et spécifiez le nom de l'emplacement sélectionné.



### Série 33500

Pour ajouter des caractères, appuyez sur la touche du curseur de droite jusqu'à ce que le curseur soit positionné à droite du nom existant, puis tournez le bouton. Pour supprimer un caractère, tournez le bouton jusqu'à obtenir le caractère d'espace avant la majuscule A. Pour supprimer tous les caractères entre la position du curseur et la fin de la ligne, appuyez sur [+/-]. Vous pouvez saisir des nombres directement à partir du clavier numérique.

### Série 33600

Sélectionnez les caractères à modifier à l'aide des flèches gauche et droite de la face avant (situées sous le bouton). Vous pouvez dépasser le dernier caractère afin d'ajouter un nouveau caractère à la fin. Puis, à l'aide du bouton, sélectionnez le caractère désiré et passez au caractère suivant pour le modifier à l'aide des flèches.

Vous pouvez supprimer un ou plusieurs caractères à l'aide des touches de fonction **Delete Char** et **Clear Entry**.

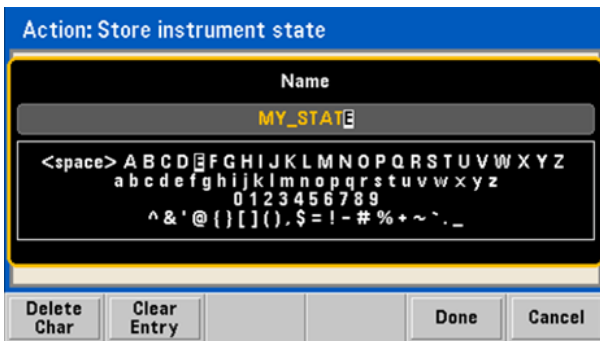

Appuyez sur **Done** lorsque vous avez terminé la saisie du nom.

- Enregistrez la configuration de l'instrument.



Pour restaurer une configuration enregistrée :



## Aide-mémoire des menus de la face avant

Ce chapitre présente brièvement les menus de la face avant. Les autres sections de ce chapitre contiennent des exemples d'utilisation des menus de la face avant.

---



### Sélectionne un signal

- Sinusoïdal
  - Carré
  - Rampe
  - Impulsion
  - Arbitraire
  - Triangulaire
  - Bruit
  - PRBS
  - CC
- 



### Configure les paramètres propres à un signal

- Période/Fréquence
- Amplitude ou tension haute/basse
- Tension résiduelle

- Phase
  - Rapport cyclique
  - Symétrie
  - Largeur d'impulsion
  - Temps de front
  - Signal arbitraire
  - Fréquence d'échantillonnage
  - Filtre
  - Phase du signal arbitraire
  - Bande passante
  - Données PRBS
  - Vitesse de transmission
- 



#### Spécifie les unités et les préférences

- Vitesse du signal arbitraire : Éch/s, Freq ou Period
  - Tension exprimée en Amplitude/Tension résiduelle ou valeur Haute/Basse
  - Unités de tension en Vpp, Veff ou dBm
  - Largeur d'impulsion ou rapport cyclique
  - Phase de rafale en degrés, radians ou secondes
  - Phase du signal arbitraire en degrés, radians, secondes ou échantillons
  - Balayage en fréquence : Centre/Plage ou Initiale/Finale
- 



#### Configure les paramètres de modulation

- Modulation active ou inactive
- Type de modulation : AM, FM, PM, PWM, BPSK, FSK ou Somme



## Consignes d'utilisation

- Source de modulation
  - Paramètres de modulation (varient selon le type de modulation)
- 



### Configure les paramètres de balayage en fréquence

- Balayage actif ou inactif
  - Type de balayage : linéaire, logarithmique ou liste de fréquences
  - Temps de balayage
  - Fréquences initiale/finale ou fréquences centre/plage
  - Délai, maintien et temps de retour
- 



### Configure les paramètres de rafale

- Rafale active ou inactive
  - Mode rafale : déclenché (N cycles) ou déclenchement externe
  - Cycles par rafale (1 à 100 000 000 ou infini)
  - Angle de phase initial de la salve ( $-360^\circ$  à  $+360^\circ$ )
  - Période de la rafale
-

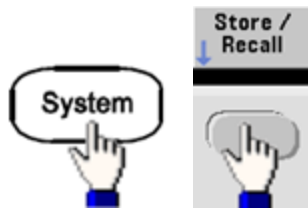

#### Enregistre et rappelle des configurations de l'instrument

- Enregistrement des configurations de l'instrument dans la mémoire non volatile.
  - Affectation de noms personnalisés aux emplacements de stockage.
  - Rappel des configurations enregistrées.
  - Suppression des configurations enregistrées.
  - Sélectionne la configuration à la mise sous tension de l'instrument (dernière extinction de l'instrument ou **configuration de sortie d'usine**).
- 

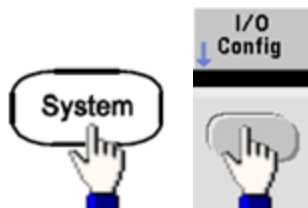

#### Configure les interfaces des entrées/sorties de l'instrument

- Activation/désactivation du réseau local
  - Configuration du réseau local (adresse IP et configuration du réseau)
  - Réinitialisation du réseau local
  - Spécification des paramètres USB
  - Sélection de l'adresse GPIB
-

## Consignes d'utilisation

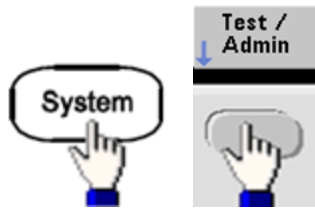

### Exécution de tâches d'administration système

- Exécution de l'autotest
  - Étalonnage de l'instrument
  - Effacement de la mémoire de l'instrument (sécurité NISPOM)
  - Installation des fonctions sous licence
  - Mise à jour du microprogramme
- 

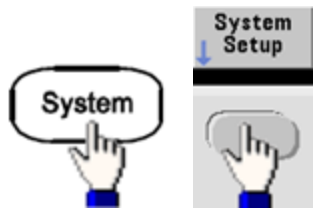

### Configuration des paramètres du système

- Configuration de l'écran
  - Sélection de la langue des messages sur la face avant et l'aide
  - Sélection de l'utilisation des points et des virgules dans les nombres affichés
  - Activation/désactivation du réseau local
  - Activation/désactivation du signal sonore d'erreur
  - Activation/désactivation des clics du clavier numérique
  - Activation/désactivation de l'écran de veille
  - Réglage de la luminosité de l'écran
  - Réglage de la date et de l'heure
  - Gestion des fichiers et des dossiers (copier, renommer, supprimer, capture d'écran, etc.)
  - Configuration de l'oscillateur de référence 10 MHz
-

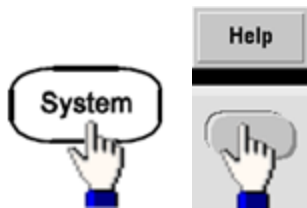

#### Affiche la liste des rubriques d'aide

- Affichage du dernier message affiché
  - Affichage de la file d'attente des erreurs de l'interface de commande à distance
  - Affichage de l'aide sur une touche
  - Savoir où obtenir de l'assistance technique
  - Affichage des données « À propos de » : numéro de série, adresse IP, version du microprogramme, etc.
- 



#### Active et configure les voies

- Activation/désactivation des voies
  - Spécification de la voie activée dans les menus
  - Sélection de l'impédance de sortie (1  $\Omega$  à 10 k $\Omega$  ou Infini)
  - Activation/désactivation de la détection automatique de l'amplitude
  - Sélection de la polarité des signaux (normale ou inversée)
  - Spécification des limites de tension
  - Spécification de la sortie normale ou commandée
  - Configuration du fonctionnement à 2 voies (couplage, suivi et combinaison)
-



### Configure les paramètres de déclenchement et le signal de sortie de déclenchement

- Exécution d'un déclenchement manuel lorsque la touche est allumée
- Spécification de la source du déclenchement du balayage, de la rafale ou du signal arbitraire
- Spécification du niveau, du nombre et du retard de déclenchement en tension
- Spécification de la pente (front montant ou descendant) de la source de déclenchement externe
- Spécification de la pente (front montant ou descendant) du signal de sortie de déclenchement
- Activation/désactivation de la sortie du signal sur le connecteur « Sync »
- Spécification de la source, de la polarité, du mode, du point de marqueur de synchronisation, etc.

### Procédure de configuration du réseau local

Plusieurs paramètres peuvent être nécessaires pour établir les communications au moyen de l'interface de réseau local. Vous devez d'abord configurer une adresse IP. Vous devrez peut-être contacter votre administrateur réseau qui vous aidera à établir les communications avec l'interface du réseau local.

1. **Sélectionnez le menu « I/O ».**  
Appuyez sur **[System]** > **I/O Config**.
2. **Sélectionnez le menu LAN Settings.**  
Appuyez sur la touche de fonction **LAN Settings**.

Vous pouvez sélectionner **Modify Settings** pour modifier les réglages du réseau local, ou bien activer/désactiver l'option LAN Services ou rétablir les paramètres réseau par défaut.



#### REMARQUE

Cet écran reflète l'affichage de la série 33500. La série 33600 inclut également un voyant d'état LAN Status dans l'angle supérieur droit pour indiquer si la connexion LAN est satisfaisante ou défectueuse.

### 3. Appuyez sur **Modify Settings**.



Pour accéder à la plupart des paramètres de cet écran, utilisez la première touche de fonction pour basculer de **DHCP** vers **Manual**. Si l'option DHCP est activée, une adresse IP est automatiquement configurée par DHCP (Dynamic Host Configuration Protocol) lorsque vous connectez l'instrument au réseau, si le serveur DHCP existe et peut effectuer cette opération. Le protocole DHCP se charge également du masque de sous-réseau et de l'adresse de la passerelle si nécessaire. Il s'agit de la manière la plus facile d'établir les communications avec le réseau local pour votre instrument. Il vous suffit de laisser l'option DHCP activée. Pour plus d'informations, contactez votre administrateur réseau.

### 4. Spécifiez une « Configuration IP ».

Si vous n'utilisez pas l'option DHCP (première touche de fonction sur **Manuel**), vous devez spécifier une configuration IP, y compris une adresse IP, et éventuellement un masque de sous-réseau et l'adresse d'une passerelle. Les boutons **IP Address** et **Subnet Mask** sont situés sur l'écran principal. Appuyez sur **More** pour configurer la passerelle.

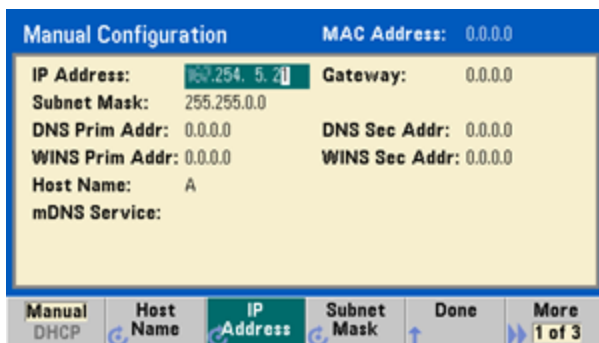

Contactez votre administrateur réseau pour obtenir l'adresse IP, le masque de sous-réseau et la passerelle à utiliser. Toutes les adresses IP sont exprimées sous la forme « nnn.nnn.nnn.nnn », où « nnn » est la valeur décimale d'un octet de 0 à 255. Vous pouvez entrer une nouvelle adresse IP sur le clavier numérique (et non avec le bouton). Tapez simplement les nombres et les points de séparation à l'aide du clavier. Utilisez le curseur de gauche comme touche de retour arrière. **Ne saisissez pas de zéro au début des nombres.**

### 5. Spécifiez la « DNS Setup » (facultatif)

DNS (Domain Name Service) est un service Internet qui traduit les noms de domaines en adresses IP. Demandez à votre administrateur réseau si ce service est utilisé ; si tel est le cas, demandez le nom d'hôte, le nom du domaine et l'adresse du serveur à utiliser.

## Consignes d'utilisation

- a. Définissez le nom d'hôte (hostname). Appuyez sur **Host Name** et entrez le nom d'hôte. Un nom d'hôte est la partie concernant l'hôte dans le nom du domaine qui est traduite en adresse IP. Vous entrez le nom d'hôte sous forme d'une chaîne de caractères au moyen du bouton et des touches de curseur pour sélectionner et modifier les caractères. Le nom d'hôte peut contenir des lettres, des chiffres et des tirets (« - »). Vous pouvez utiliser le clavier uniquement pour les chiffres.
- b. Définissez les adresses des serveurs DNS. Dans l'écran de configuration du réseau, appuyez sur **More** pour accéder au deuxième ensemble de touches de fonction.

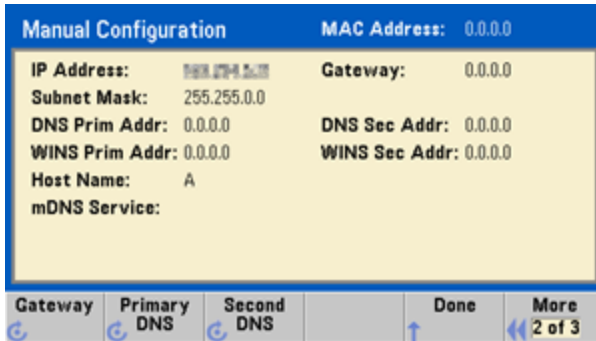

Entrez les serveurs DNS principal et secondaire. Pour plus d'informations, consultez votre administrateur réseau.

### En savoir plus sur les adresses IP et la notation par points

Les adresses notées par points (« nnn.nnn.nnn.nnn », où « nnn » représente la valeur d'un octet comprise entre 0 et 255) doivent être exprimées avec soin du fait que la plupart des logiciels des PC interprètent les octets avec des zéros initiaux comme des nombres en base 8. Par exemple, « 192.168.020.011 » est équivalent à la notation décimale « 192.168.16.9 », car « .020 » est interprété comme « 16 » en base 8 et « .011 » comme « 9 ». Pour éviter toute confusion, utilisez uniquement des valeurs décimales comprises entre 0 et 255 sans zéro au début.

### Configuration d'un signal arbitraire

L'instrument comprend un éditeur de signaux intégré qui permet de créer et de modifier des signaux arbitraires. Vous pouvez créer ces signaux en modifiant directement des tensions ou en utilisant une combinaison de 12 types de signaux standard différents maximum.

Ce didacticiel crée et modifie un signal ordinaire.

### Insérer des signaux prédéfinis

1. Appuyez sur **[Waveforms] > Arb > Arbs** pour démarrer l'éditeur de signaux intégré. Appuyez sur **Edit New**, acceptez le nom de fichier par défaut, puis sélectionnez **Start Editor**. Vous avez à présent un signal de 0 Vcc composé exactement de 8 points (série 33500) ou de 32 points (série 33600).

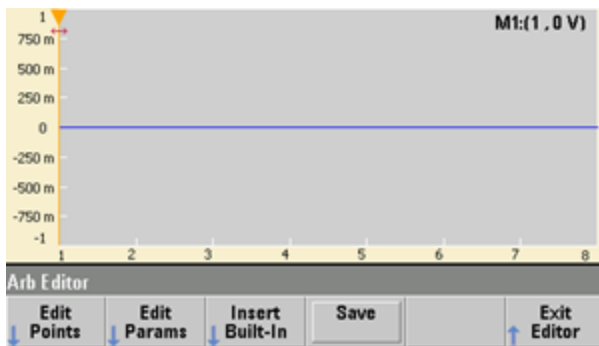

**REMARQUE** Les autres sections de ce didacticiel sont basées sur l'éditeur de signaux intégré d'un instrument de la série 33500, qui inclut une taille minimale de signal de 8 points. Si vous utilisez ce didacticiel sur un instrument série 33600, notez que la taille minimale de signal pour l'éditeur de signaux intégré est de 32 points.

- Appuyez sur **Insert Built-in** > **Choose Wave**. Sélectionnez **D-Lorentz** à l'aide du bouton ou des flèches ci-dessous, puis appuyez sur **OK**. Utilisez le clavier et la touche de fonction **V** qui s'affiche lorsque vous commencez à taper sur le clavier pour définir le paramètre **Amplitude** sur 2 V, puis appuyez sur **OK**. Le signal comporte à présent 100 points supplémentaires, du fait que le signal D-Lorentz de 100 points a été inséré à l'avant du signal initial.



- Supposons que vous souhaitez annuler la modification effectuée. Appuyez sur **[System]** > **Undo**. Vous êtes à présent revenu au signal 0 V d'origine.





## Consignes d'utilisation

4. Pour revenir au signal D-Lorentz, appuyez sur **Redo**. Appuyez ensuite sur **Done** pour terminer.



5. Nous allons maintenant insérer un signal sinusoïdal. Appuyez d'abord sur **Choose Wave**. Assurez-vous que l'option Sinusoïdal (par défaut) est en surbrillance et appuyez sur **OK**. Pour obtenir de l'aide sur la signification des divers paramètres affichés, appuyez sur **Parameter Help**. Appuyez ensuite sur **Done** pour quitter l'écran d'aide.

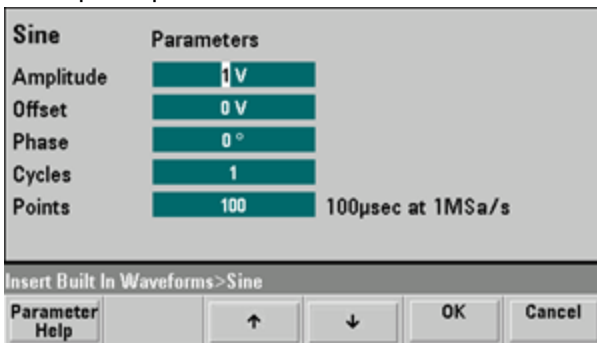

6. À l'aide du clavier numérique et des touches fléchées vers le haut et vers le bas, configurez le paramètre **Amplitude** sur 3,5 V, le paramètre **Cycles** sur 4 et le paramètre **Points** sur 200. Conservez les valeurs par défaut des autres paramètres, puis appuyez sur **OK**.

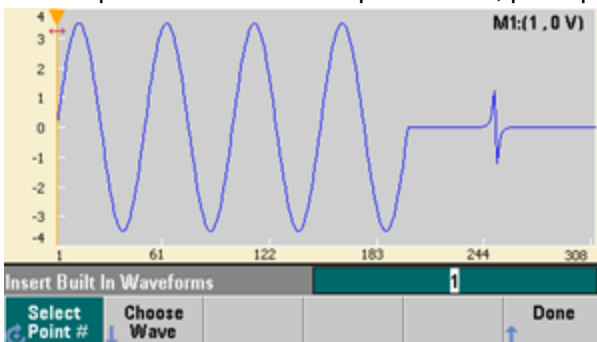

7. Notez que la première touche de fonction **Select Point #** est affichée en surbrillance. Positionnez le marqueur sur le 270e point du signal en saisissant 270 sur le clavier numérique et en appuyant sur **Enter**.

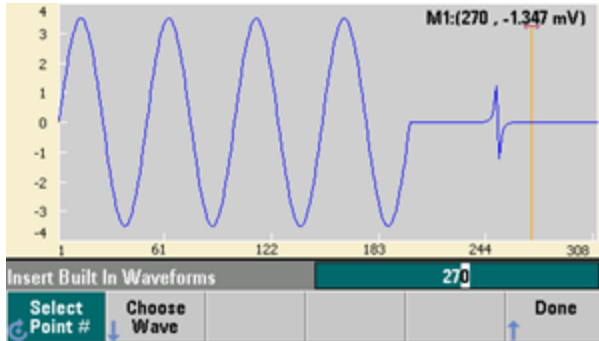

8. Appuyez sur **Choose Wave**, sélectionnez **Square**, puis appuyez sur **OK**. Configurez le paramètre Amplitude sur 3 V, le paramètre Tension résiduelle sur -2 V, le paramètre Cycles sur 8 et le paramètre Points sur 100. Appuyez sur **OK**. Notez que les 8 cycles du signal carré sont insérés après le marqueur. Appuyez sur **Done**.

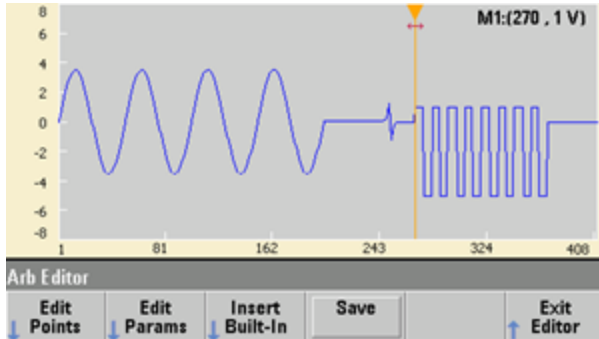

### Modifier les caractéristiques du signal

1. Appuyez sur **Edit Params**, puis configurez le paramètre **Sampling Rate** sur 100 éch/s. Appuyez sur **Cycle Period** ; remarquez que ce dernier paramètre a été défini à 4,08 secondes. En effet, le signal comporte 408 points d'échantillonnage et la fréquence d'échantillonnage est de 100 éch/s.

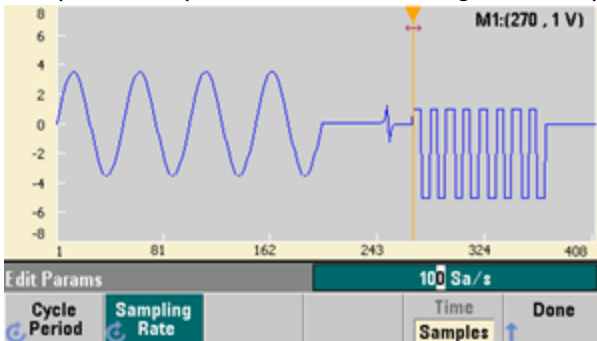

2. Modifiez le paramètre **Cycle Period** à 2,04 secondes, puis appuyez sur **Sampling Rate**. Elle est alors égale à 200 éch/s afin d'émettre les 408 points du signal en 2,04 secondes.

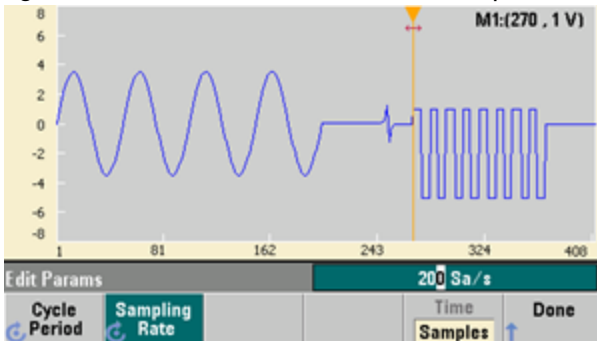

3. Appuyez sur **Done** pour quitter l'écran de modification des paramètres. Appuyez sur **Edit Points** ; notez que la touche de fonction **Point #** est mise en surbrillance. Entrez le nombre 160, puis appuyez sur **Enter** pour déplacer le marqueur.



4. Appuyez sur **Voltage** and modifiez la tension du point sélectionné à 4,2 V. Appuyez sur **Point #** modifiez le marqueur du point à 150 pour retirer le marqueur de ce point. Lorsque vous appuyez sur **Enter** pour terminer la saisie du point 150, vous constatez une anomalie de 4,2 V dans le signal que vous venez de créer au point 160.



## Zoom et panoramique

1. Pour voir le point en détail, appuyez sur **[System] > Pan/Zoom Control**. Notez que la première touche de fonction est **Horizontal**, ce qui signifie que l'agrandissement que nous allons effectuer aura lieu sur l'axe horizontal (temps). Modifiez le paramètre **Zoom** à 500 %. L'anomalie du signal sinusoïdal devient alors plus évidente.

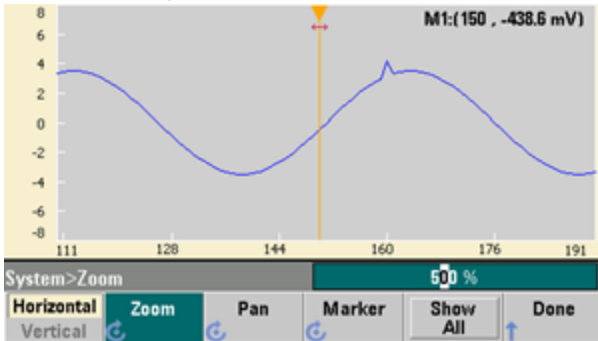

2. Configurez alors la première touche de fonction sur **Vertical** pour un agrandissement vertical. Configurez le paramètre **Zoom** sur 500 %. Notez que nous avons agrandi l'axe de tension. Cependant, nous nous trouvons trop bas pour voir apparaître l'anomalie de 4,2 V dans le signal sinusoïdal.



3. Appuyez sur **Pan** et configurez le paramètre **Pan** sur 3 V pour vous déplacer vers le haut du signal. Le point 4,2 V est à présent clairement visible.

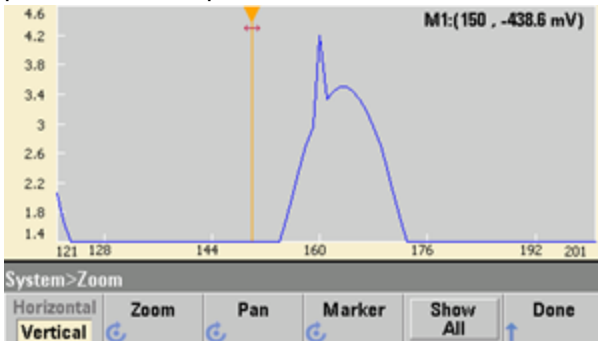

4. Pour afficher à nouveau le signal complet, appuyez sur **Show All**. Appuyez ensuite sur **Done** à deux reprises pour retourner à l'écran **Edit Points**.

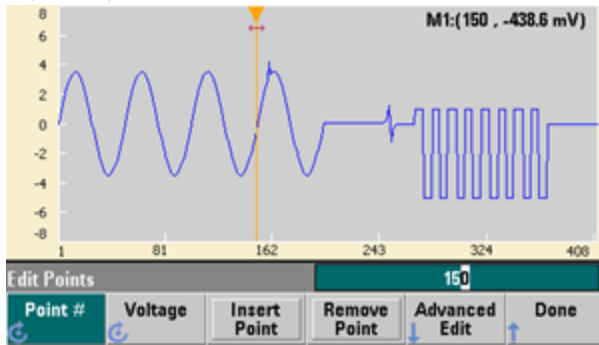

### Insérer, supprimer, copier et coller des points

1. Appuyez sur **Insert Point** à 15 reprises et examinez attentivement l'écran. Vous constatez la présence de 15 nouveaux points dans le signal au même niveau de tension.



2. Modifiez la valeur du paramètre **Point #** à 220 et appuyez sur **Remove Point** à 20 reprises, en examinant attentivement l'écran. Vous noterez que les points sont supprimés du signal.



## Consignes d'utilisation

- Vous pouvez également utiliser un tableau de tensions pour modifier des points. Appuyez sur **Advanced Edit > Edit Via Table**. Configurez le paramètre **Point #** sur 200, puis configurez le paramètre **Voltage** pour le point 200 sur 3 V. Parcourez les lignes à l'aide du bouton et configurez le paramètre **Voltage** pour les points 205 et 210 à 3 V. Appuyez sur **Done**.

Point No. (Max 403)	Voltage Value (Volts)
203	-3.49309
204	-3.49309
205	3.00000
206	-3.32870
207	-3.16890
208	-2.95515
209	-2.69680
210	3.00000

Edit Points>Table 210

Point # Voltage Insert Point Remove Point Done

- Notez les trois pics de 3 V que vous venez de placer dans le signal aux points 200, 205 et 210.

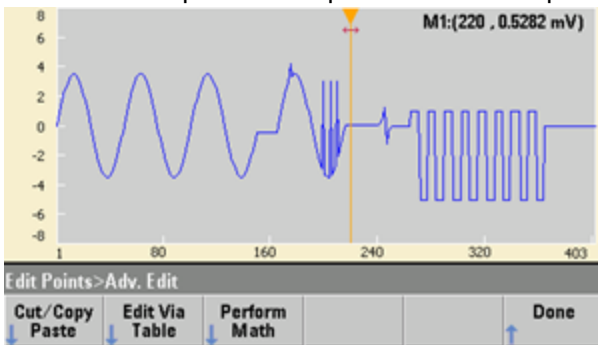

- Appuyez sur **Cut/Copy Paste**, puis modifiez le paramètre **Marker** à une valeur comprise entre 1 et 150. Appuyez ensuite sur la première touche de fonction et basculez de **Marker** vers **Marker 2**. Configurez le paramètre **Marker 2** sur 300. La plage définie par les marqueurs est alors surlignée en noir.



6. Appuyez sur **Copy**, sur **Paste**, puis sur **At Start**. Notez que la partie que vous avez copiée est maintenant dupliquée au début du signal.

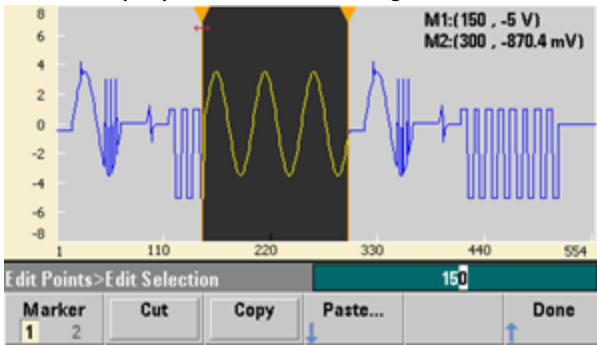

7. Appuyez maintenant sur **Paste** > **At End**. La même partie du signal apparaît à présent tout à la fin.

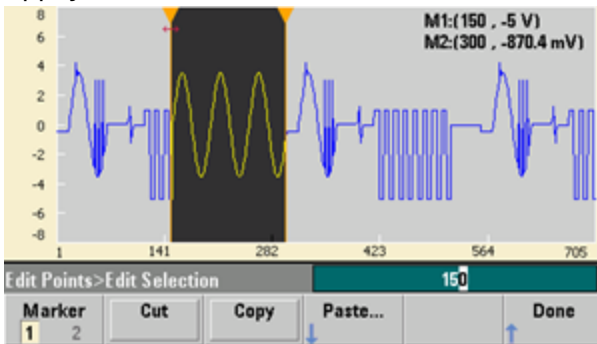

8. Appuyez maintenant sur **Paste** et modifiez la valeur du paramètre **Point #** à 500. Appuyez ensuite sur **OK**; la même partie du signal sera collée au point 500. Appuyez sur **Done** pour quitter le menu **Cut/Copy Paste**.

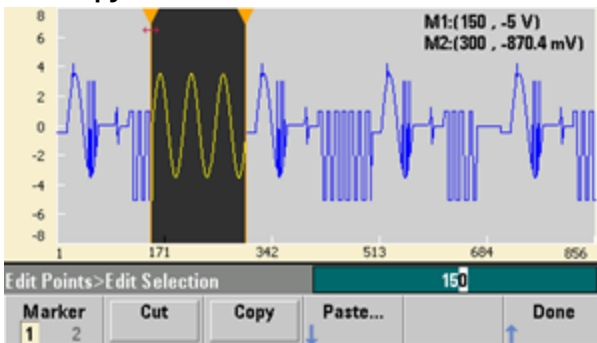



## Opérations mathématiques

L'éditeur de signaux intégré permet d'effectuer des opérations mathématiques sur le signal. Positionnez d'abord les marqueurs pour définir la plage du signal que vous voulez modifier. Vous pouvez alors ajouter, soustraire ou multiplier cette partie du signal par un autre signal ; vous pouvez également transformer le signal sans impliquer d'autres signaux.

1. Appuyez sur **Perform Math**. Configurez le paramètre **Marker 1** sur 400 et le paramètre **Marker 2** sur 500.

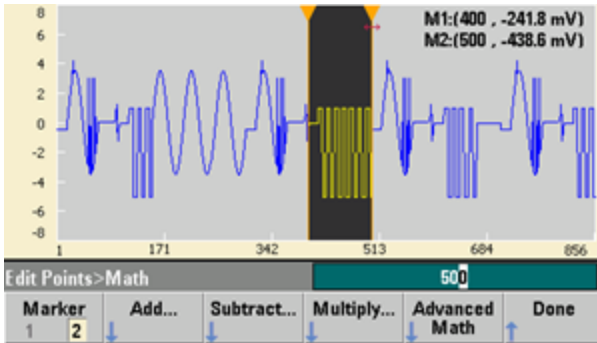

2. Appuyez sur **Add**, puis sélectionnez **Haversine** et **OK**. Configurez le paramètre **Amplitude** sur 3 V, le paramètre Offset sur 0 V, puis appuyez sur **OK**. Notez que la partie surlignée s'élève au centre suite à l'ajout de **Haversine**.

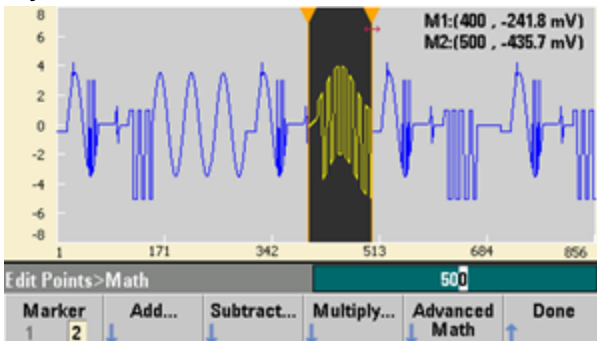

3. Appuyez maintenant sur **Multiply** et sélectionnez le signal **Sine** (appuyez sur **OK**). Configurez le paramètre **Cycles** sur 2, puis appuyez sur **OK**.

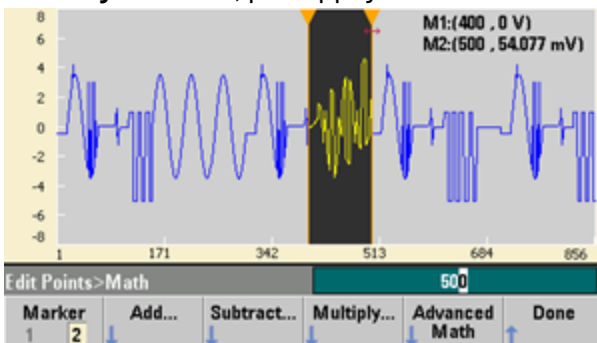

4. Configurez maintenant le paramètre **Marker 1** sur 200 et le paramètre **Marker 2** sur 600.

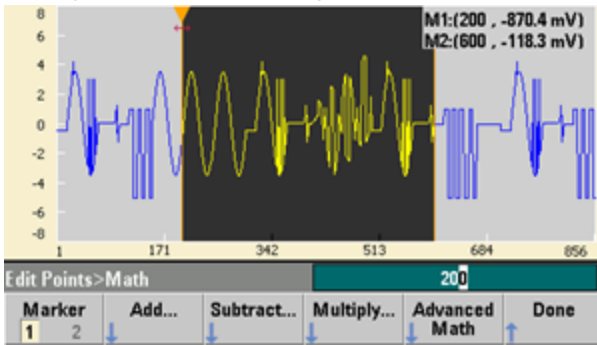

5. Appuyez sur **Advanced Math > Mirror > OK**.

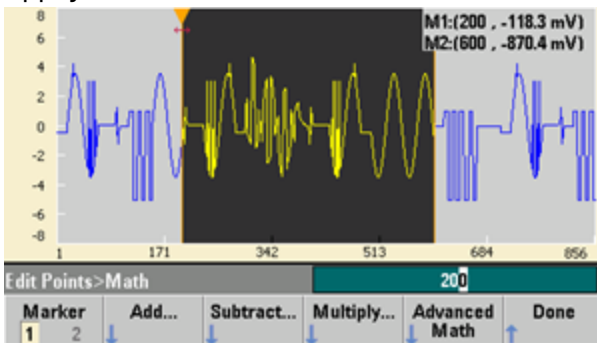

6. Continuez à découvrir l'interface en testant d'autres fonctions **mathématiques avancées**, telles que **Invert**, **Absolute**, **Scale**, etc. Pour de plus amples informations, appuyez sur **Operation Help**.

## Caractéristiques et fonctions

Cette section contient des informations détaillées sur les caractéristiques de l'instrument, et notamment sur l'utilisation des commandes de la face avant et de l'interface distante. Vous pouvez, si vous le souhaitez, consulter en premier lieu la section [Aide-mémoire des menus de la face avant](#). Pour plus d'informations sur les commandes et les requêtes SCPI, reportez-vous à la section [Référence de programmation SCPI](#). Cette section couvre les rubriques suivantes :

[Configuration de la sortie](#)

[Trains d'impulsions](#)

[Modulation d'amplitude \(AM\) et modulation de fréquence \(FM\)](#)

[Modulation de phase \(PM\)](#)

[Modulation par déplacement de fréquence \(FSK\)](#)

[Modulation de largeur d'impulsion \(PWM\)](#)

[Modulation par addition](#)

[Balayage en fréquence](#)

[Mode rafale](#)

[Déclenchements](#)

[Opérations sur 2 voies](#)

[IQ Player \(option\)](#)

[Opérations système](#)

[Configuration de l'interface distante](#)

[Référence de base de temps externe](#)

[Éditeur de signaux intégré](#)

Des états et des valeurs « par défaut » sont identifiés tout au long de ce document. Il s'agit des **états par défaut à la mise sous tension** si vous n'avez pas activé le mode de rappel à l'extinction (reportez-vous à la section **Enregistrement des états de l'instrument**).

## Configuration de la sortie

Cette section décrit la configuration des voies de sortie. De nombreuses commandes de configuration de la sortie commencent par SOURce1: ou SOURce2: pour indiquer une voie donnée. Si cette dernière n'est pas spécifiée, la voie par défaut est la voie 1. Par exemple, **VOLT 2.5** configure la sortie de la voie 1 sur 2,5 V et **SOUR2:VOLT 2.5** produit le même résultat pour la voie 2.

L'écran de l'instrument affiche pour chaque voie un onglet qui récapitule divers aspects de la configuration de sortie :



Sur un instrument 2 voies, l'onglet de la voie 1 est jaune ; celui de la voie 2 est vert.

## Fonction de sortie

L'instrument comporte 8 signaux standard : sinusoïdal, carré, rampe, impulsion, triangle, bruit, PRBS (séquence binaire pseudo-aléatoire) et CC. Il existe également 9 signaux arbitraires prédéfinis et vous pouvez créer des signaux personnalisés à l'aide de l'éditeur de signaux intégré.

Le tableau ci-dessous indique les fonctions autorisées (·) en modulation, balayage et rafale. La sélection d'une fonction non autorisée avec une modulation ou un mode entraîne la désactivation de cette modulation ou de ce mode.

Signal porteur	AM	FM	PM	FSK	BPSK	PWM	Somme	Rafale	Balayage
Sinusoïdal et carré	·	·	·	·	·		·	·	·
Impulsion	·	·	·	·	·	·	·	·	·
Triangulaire et rampe	·	·	·	·	·		·	·	·
Bruit gaussien	·						·	·a	
PRBS	·	·	·				·	·	
Signal arbitraire	·	·	·b		·b		·	·	·
Séquence	·						·		

(a) Rafale commandée uniquement

(b) S'applique à l'horloge d'échantillonnage, et non à l'ensemble du signal

- Limitations concernant la fréquence : Toute modification d'une fonction peut se répercuter sur la fréquence afin de correspondre aux limites fréquentielles de la nouvelle fonction.
- Limitations concernant l'amplitude : Lorsque l'unité de sortie est Vrms ou dBm, la modification de fonctions peut diminuer l'amplitude au minimum pour la nouvelle fonction du fait d'une variation des formes de signaux. Par exemple, un signal carré de 5 Veff (dans une impédance de 50 Ω) remplacé par un signal sinusoïdal diminue l'amplitude à 3,536 Veff (limite supérieure du signal sinusoïdal).
- Il n'est pas possible de combiner l'amplitude et la tension résiduelle pour dépasser les caractéristiques limites de l'instrument. Il est possible de modifier la dernière configuration afin de rester dans les limites.
- Vous pouvez spécifier les limites supérieure et inférieure de la tension de sortie pour protéger un dispositif testé.
- **Face avant :**

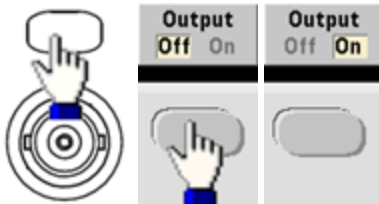

Pour sélectionner un autre signal :



- Par exemple, pour spécifier un signal CC :



Pour envoyer la sortie CC :

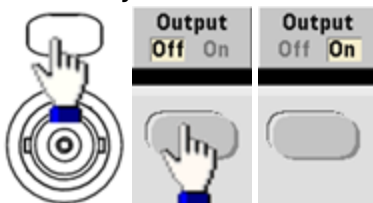

- **SCPI:** `[SOURce[1|2]:]FUNction <fonction>`

La commande **APPLy** configure un signal à l'aide d'une commande unique.

## Fréquence de sortie

La plage de fréquence de sortie varie selon la fonction, le modèle et la tension de sortie, comme indiqué [ici](#). La fréquence par défaut est de 1 kHz pour toutes les fonctions et les fréquences minimales sont indiquées dans le tableau ci-dessous.

Fonction	Fréquence minimale
Sinusoidal	1 $\mu$ Hz
Carré	1 $\mu$ Hz
Rampe/tri.	1 $\mu$ Hz
Impulsion	1 $\mu$ Hz
PRBS	1 $\mu$ bps
Arbitraire	1 $\mu$ .éch/s

- Limitations concernant la fréquence : Toute modification d'une fonction peut se répercuter sur la fréquence afin de correspondre aux limites fréquentielles de la nouvelle fonction. Les signaux arbitraires conservent leur dernier paramètre de fréquence.
- Limitations sur les rafales : Pour les rafales déclenchées en interne, la fréquence minimale est de 126  $\mu$ Hz.
- Limitations sur le rapport cyclique : Pour les signaux carrés et les impulsions sur la série 33500, le rapport cyclique est limité par la largeur minimale des impulsions spécifiée de 16 ns. Par exemple, à 1 kHz, il est possible de définir un rapport cyclique aussi faible que 0,01 % du fait que cela implique une largeur d'impulsion de 100 ns. À 1 MHz, le rapport cyclique est de 1,6 % et à 10 MHz, il est de 16 %. Toute modification à une fréquence qui ne génère pas le rapport cyclique actuel entraîne un ajustement du rapport cyclique pour remplir la condition de largeur minimale des impulsions.

Sur la série 33500, la largeur d'impulsion minimale est de 16 ns. Sur la série 33600, la largeur d'impulsion minimale est de 5 ns jusqu'à 4 Vpp et de 8 ns jusqu'à 10 Vpp.

- **Face avant :**



- **SCPI:** `[SOURce[1|2]:]FREQuency {< fréquence>|MINimum|MAXimum|DEFault}`

La commande **APPLY** configure un signal à l'aide d'une commande unique.

## Amplitude de sortie

L'amplitude par défaut est de 100 mVpp (dans une impédance de 50 Ω) pour toutes les fonctions.

- Limitations de la tension résiduelle : La relation entre l'amplitude et la tension résiduelle est indiquée ci-dessous.  $V_{max}$  est de  $\pm 5$  V pour une charge de 50 Ω ou de  $\pm 10$  V pour une charge de haute impédance.

$$V_{pp} < 2(V_{max} - |V_{offset}|)$$

- Limites imposées par l'impédance de sortie : Si l'amplitude est de 10 Vpp et si vous modifiez la terminaison de sortie de 50 Ω à « haute impédance » (**OUTPut[1|2]:LOAD INF**), l'amplitude double pour atteindre 20 Vpp. Toute modification de la « haute impédance » à 50 Ω réduit de moitié l'amplitude affichée. L'impédance de sortie n'affecte pas la tension de sortie réelle. Elle modifie uniquement les valeurs affichées et récupérées de l'interface distante. La tension de sortie réelle varie en fonction de la charge connectée.
- Limites imposées par la sélection de l'unité : Les limites d'amplitude sont parfois déterminées par l'unité de sortie sélectionnée. Cela peut se produire lorsque l'unité est Veff ou dBm en raison des différences entre les facteurs de crête de diverses fonctions. Par exemple, si vous modifiez un signal carré 5 Vrms (dans une charge de 50 Ω) en signal sinusoïdal, l'instrument ajuste l'amplitude à 3,536 Veff (limite maximale Vrms pour un signal sinusoïdal). L'interface distante génère également une erreur de conflit des paramètres.
- Vous pouvez exprimer l'amplitude en Vpp, Veff ou dBm. Vous ne pouvez pas spécifier l'amplitude de sortie en dBm si la terminaison de sortie est réglée sur une impédance élevée. Pour plus d'informations, reportez-vous à la section **Unités de sortie**.
- Limitations concernant les signaux arbitraires : Pour les signaux arbitraires, l'amplitude est limitée si les points du signal ne couvrent pas toute la plage du convertisseur N/A de sortie. Par exemple, le signal intégré « Sinc » n'utilise pas la plage totale de valeurs ; son amplitude est donc limitée à 6,087 Vpp (dans une charge de 50 Ω).
- La modification de l'amplitude peut interrompre brièvement la sortie à certaines tensions en raison de la commutation de l'atténuateur de sortie. Néanmoins, l'amplitude est contrôlée de façon que la tension de sortie ne soit jamais supérieure au réglage actuel lorsque la commutation a lieu. Pour éviter cette interruption, désactivez la détection automatique de la tension à l'aide de la commande **VOLTage:RANGe:AUTO OFF**. La commande **APPLY** active automatiquement la détection automatique.
- La configuration des niveaux haut et bas entraîne également celle de l'amplitude et de la tension résiduelle du signal. Par exemple, si vous réglez le niveau haut sur +2 V et le niveau bas sur -3 V, l'amplitude résultante est de 5 Vpp avec une tension résiduelle de -500 mV.
- La **tension résiduelle CC** contrôle le niveau de sortie CC d'un signal. Le niveau de sortie CC peut être compris entre  $\pm 5$  V dans une charge de 50 Ω ou entre  $\pm 10$  V avec une charge de haute impédance.

## Consignes d'utilisation

- **Face avant :**



Pour un niveau haut et un niveau bas à la place :



- **SCPI:**

[SOURCE[1|2]:]VOLTage {<amplitude>|MINimum|MAXimum|DEFAULT}

[SOURCE[1|2]:]VOLTage:HIGH {<tension>|MINimum|MAXimum|DEFAULT}

[SOURCE[1|2]:]VOLTage:LOW {<tension>|MINimum|MAXimum|DEFAULT}

La commande **APPLY** configure un signal à l'aide d'une commande unique.

## Tension CC résiduelle

La tension résiduelle par défaut est de 0 V pour toutes les fonctions.

- Limites imposées par l'amplitude : Le rapport entre la tension résiduelle et l'amplitude de sortie est illustré ci-dessous. La tension de sortie en crête (somme des tensions CC et CA) ne peut être supérieure aux caractéristiques nominales de l'instrument output rating ( $\pm 5$  V dans une charge de  $50 \Omega$  ou  $\pm 10$  V dans un circuit ouvert).
- Le rapport entre la tension résiduelle et l'amplitude de sortie est illustré ci-dessous.  $V_{max}$  est la tension de crête maximale compte tenu de l'impédance de sortie déclarée (soit 50 V pour une charge de  $50 \Omega$  ou 10 V pour une charge haute impédance).

$$|V_{offset}| < V_{max} - V_{pp}/2$$

Si la tension résiduelle saisie est incorrecte, l'instrument la règle au niveau maximal autorisé avec l'amplitude spécifiée. Sur l'interface distante, l'erreur « Data out of range » est également générée.

- Limites imposées par l'impédance de sortie : La plage de la tension résiduelle dépend de l'impédance de sortie. Par exemple, si vous configurez une tension résiduelle de 100 mVcc et modifiez ensuite l'impédance de sortie de  $50 \Omega$  à « haute impédance », la tension résiduelle affichée sur la face avant est multipliée par deux et passe à 200 mVcc (aucune erreur générée). Si vous passez de « haute impédance » à  $50 \Omega$ , la tension résiduelle affichée est divisée par deux. Pour plus d'informations, reportez-vous à la commande **OUTPut[1|2]:LOAD**. La modification de l'impédance de sortie n'a aucune répercussion sur la tension aux bornes de sortie de l'instrument. Seules les valeurs affichées sur la face avant et les valeurs demandées sur l'interface distante sont modifiées. La tension sur la sortie de l'instrument dépend de la charge connectée à l'instrument. Pour plus d'informations, reportez-vous à la commande **OUTPut[1|2]:LOAD**.
- Limitations concernant les signaux arbitraires : Pour les signaux arbitraires, l'amplitude est limitée si les points du signal ne couvrent pas toute la plage du convertisseur N/A de sortie. Par exemple, le signal intégré « Sinc » n'utilise pas la plage totale de valeurs ; son amplitude est donc limitée à 6,087 Vpp (dans une charge de  $50 \Omega$ ).
- La configuration des niveaux haut et bas entraîne également celle de l'amplitude et de la tension résiduelle du signal. Par exemple, si vous réglez le niveau haut sur +2 V et le niveau bas sur -3 V, l'amplitude résultante est de 5 Vpp avec une tension résiduelle de -500 mV.
- Pour envoyer une tension continue, sélectionnez la fonction tension continue (CC - **FUNction DC**) et réglez ensuite la tension résiduelle (**VOLTage:OFFSet**). Les valeurs acceptées sont comprises entre  $\pm 5$  Vcc dans une charge de  $50 \Omega$  ou  $\pm 10$  Vcc dans un circuit ouvert. Lorsque l'instrument est en mode CC, le réglage de l'amplitude ne produit aucun effet.

- **Face avant :**





## Consignes d'utilisation

- **SCPI:**

[SOURCE[1|2]:]VOLTage:OFFSet {< tension résiduelle>|MINimum|MAXimum|DEFAULT}

[SOURCE[1|2]:]VOLTage:HIGH {< tension>|MINimum|MAXimum|DEFAULT}

[SOURCE[1|2]:]VOLTage:LOW {< tension>|MINimum|MAXimum|DEFAULT}

La commande **APPLY** configure un signal à l'aide d'une commande unique.

### Unités de sortie

S'appliquent uniquement à l'amplitude.

- Unités de sortie : Vpp (par défaut), Veff ou dBm.
- Ce paramètre est volatile.
- La sélection des unités s'applique aux opérations effectuées sur la face avant et l'interface distante. Par exemple, si vous sélectionnez « VRMS » sur l'interface distante, l'unité affichée sur la face avant est « VRMS ».
- Les unités d'amplitude ne peuvent pas être exprimées en dBm si l'impédance de sortie est configurée sur une impédance élevée. Le calcul de l'amplitude en dBm nécessite une impédance finie de la charge. Dans ce cas, la valeur est convertie en Vpp.
- La conversion des unités est possible. Par exemple, pour convertir 2 Vpp à la valeur Veff équivalente :

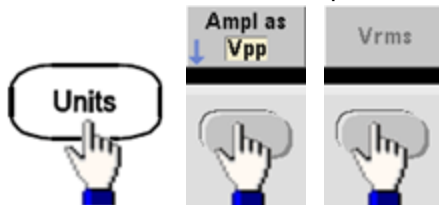

La valeur convertie est de 707,1 mVeff pour un signal sinusoïdal.

- **Face avant :**

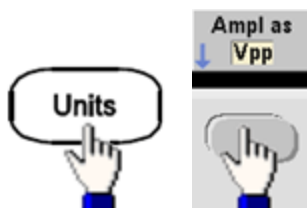

- **SCPI:** [SOURCE[1|2]:]VOLTage:UNIT {VPP|VRMS|DBM}

## Impédance de sortie

L'instrument comporte un ensemble constant d'impédances de sortie de 50  $\Omega$  sur les connecteurs de la face avant. Si l'impédance de charge réelle diffère de la valeur spécifiée, l'amplitude et les niveaux de décalage affichés seront incorrects. Le réglage de l'impédance de la charge est simplement un moyen pratique de garantir que la tension affichée correspond à la charge attendue.

- Impédance de sortie : 1  $\Omega$  à 10 k $\Omega$  ou infinie. La valeur par défaut est 50  $\Omega$ . L'onglet au-dessus de chaque voie indique la valeur de ce paramètre.

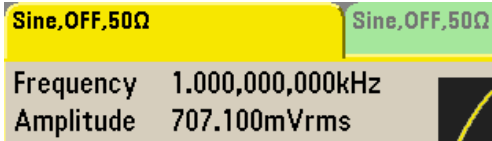

- Si vous spécifiez une impédance de 50  $\Omega$ , mais effectuez en réalité la terminaison dans un circuit ouvert, la sortie sera égale à 2 fois la valeur spécifiée. Par exemple, si vous configurez la tension résiduelle CC avec la valeur 100 mVcc (et spécifiez une charge de 50  $\Omega$ ), mais effectuez la terminaison dans un circuit ouvert, la tension résiduelle réelle sera de 200 mVcc.
- Toute modification du réglage de l'impédance de sortie entraîne un ajustement de l'amplitude et la tension résiduelle affichées (aucune erreur générée). Si l'amplitude est de 10 Vpp et si vous modifiez la terminaison de sortie de 50  $\Omega$  à « haute impédance » (OUTPut[1|2]:LOAD INF), l'amplitude double pour atteindre 20 Vpp. Toute modification de la « haute impédance » à 50  $\Omega$  réduit de moitié l'amplitude affichée. L'impédance de sortie n'affecte pas la tension de sortie réelle. Elle modifie uniquement les valeurs affichées et récupérées de l'interface distante. La tension de sortie réelle varie en fonction de la charge connectée.

**REMARQUE** La charge de sortie peut affecter la qualité du signal pour les fonctions d'impulsion et autres avec des transitions à haute vitesse. Une résistance de charge élevée peut produire des réflexions.

- L'unité est convertie en Vpp si l'impédance de sortie est une impédance élevée.
- Vous ne pouvez pas modifier l'impédance de sortie lorsque les limites de tension sont actives du fait que l'instrument ne peut pas savoir à quelle impédance ces limites s'appliquent. À la place, désactivez les limites de tension, configurez la nouvelle valeur d'impédance, ajustez les limites de tension et réactivez-les.

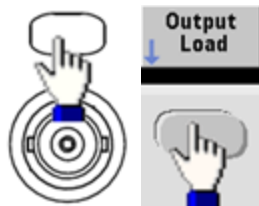

- **Face avant :**
- **SCPI:** `OUTPut[1|2]:LOAD {<ohms>|INFinity|MINimum|MAXimum|DEFault}`

## Rapport cyclique (signaux carrés)

Le rapport cyclique d'un signal carré est la partie de la durée d'un cycle pendant laquelle le signal est haut (en supposant que le signal n'est pas inversé). (Pour plus d'informations sur le rapport cyclique des impulsions, reportez-vous à la section [Pulse Waveforms](#).)

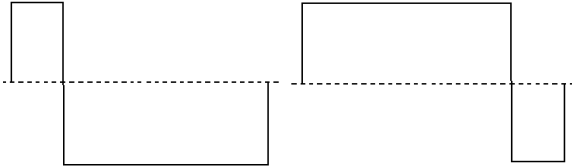

### Rapport cyclique de 20 %    Rapport cyclique de 80 %

- Rapport cyclique : 0,01 % à 99,99 % à basse fréquence ; plage réduite à plus haute fréquence. Enregistré en mémoire volatile ; 50 % par défaut.
- Ce paramètre est conservé lorsque vous passez à une autre fonction. Un rapport cyclique de 50 % est toujours utilisé pour un signal carré modulant ; le rapport cyclique s'applique uniquement à un signal porteur carré.
- **Face avant :**



Si vous utilisez le clavier, appuyez sur la touche de fonction **Percent** pour terminer :



- **SCPI:** `[SOURce[1|2]:]FUNction:SQUare:DCYClE {<pourcentage>|MINimum|MAXimum}`

La commande **APPLY** configure le rapport cyclique sur 50 %.

## Symétrie (rampes)

S'applique uniquement aux rampes. La symétrie représente la partie de chaque cycle pendant laquelle la rampe est croissante (en supposant que le signal n'est pas inversé).

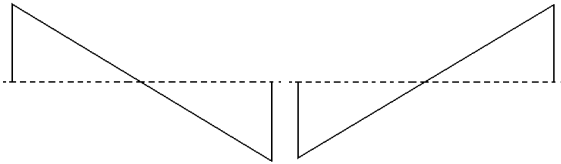

**Symétrie de 0 %**

**Symétrie de 100 %**

- La symétrie (par défaut de 100 %) est enregistrée en mémoire volatile et conservée lorsque vous changez de type de signal.
- Lorsqu'une rampe est le signal modulant AM, FM, PM ou PWM, la symétrie ne s'applique pas.
- **Face avant :**

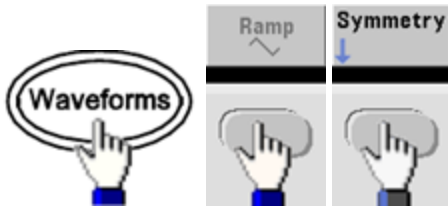

Sélectionnez ensuite l'une des options suivantes. L'option **Symétrie** permet de spécifier une valeur à l'aide du bouton ou du clavier.

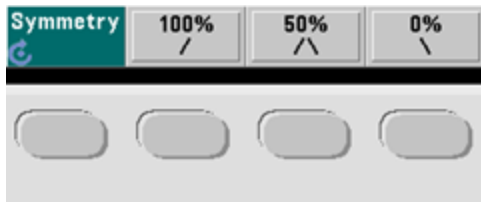

Si vous utilisez le clavier, appuyez sur la touche de fonction **Percent** pour terminer :



- **SCPI:** `[SOURce[1|2]:]FUNction:RAMP:SYMMetry {<pourcentage>|MINimum|MAXimum|DEFault}`

La commande **APPLY** configure la symétrie sur 100 %.

## Détection automatique de la tension

La détection automatique est activée par défaut et l'instrument sélectionne les paramètres optimaux de l'atténuateur. Lorsque la détection automatique est désactivée, l'instrument utilise les paramètres actifs de l'atténuateur et ne commute pas les relais de l'atténuateur.

- Vous pouvez désactiver la détection automatique pour supprimer les interruptions momentanées dues à la commutation de l'atténuateur lors d'une modification de l'amplitude. Cependant :
- La précision et la résolution de l'amplitude et de la tension résiduelle (fidélité du signal) peuvent être affectées si l'amplitude diminue au-dessous d'une modification de la plage qui se produit si la détection automatique est activée.
- Vous ne pourrez peut-être pas obtenir l'amplitude minimale lorsque la détection automatique est activée.
- Certaines spécifications de l'instrument ne s'appliquent pas lorsque la détection automatique est désactivée.
- **Face avant :**

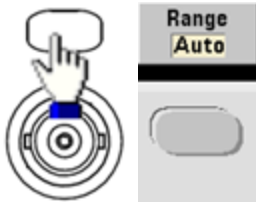

ou

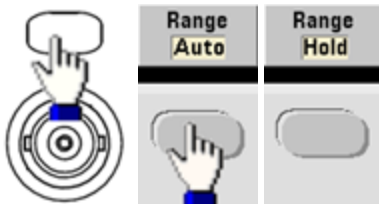

- **SCPI:** `[SOURce[1|2]:]VOLTage:RANGe:AUTO {OFF|0|ON|1|ONCE}`

La commande **APPLY** active toujours la détection automatique.

## Contrôle de la sortie

Par défaut, la sortie d'une voie est désactivée à la mise sous tension afin de protéger d'autres équipements. Pour activer la sortie d'une voie, reportez-vous à la section ci-dessous. Lorsque la sortie d'une voie est activée, le bouton de cette voie est allumé.

- Si un circuit externe applique une tension trop élevée au connecteur de sortie d'une voie, l'instrument génère un message d'erreur et désactive la sortie. Pour réactiver la sortie, supprimez la surcharge et activez à nouveau la voie.
- **Face avant :**

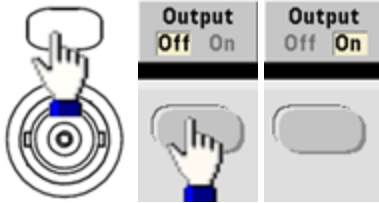

- **SCPI:** `OUTPut[1|2] {ON|1|OFF|0}`

La commande **APPLy** active toujours le connecteur de sortie d'une voie.

## Polarité des signaux

En mode normal (par défaut), le signal est positif au début du cycle. En mode inversé, c'est le contraire.

- Le signal ci-dessous est inversé par rapport à la tension résiduelle. La tension résiduelle ne change pas lorsque le signal est inversé.

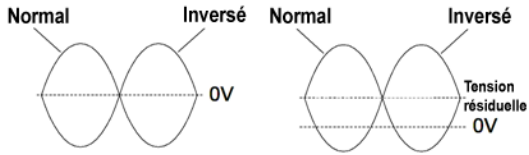

Sans tension résiduelle    Avec tension résiduelle

- Le signal **Sync** associé à un signal inversé n'est pas inversé.

- Face avant :

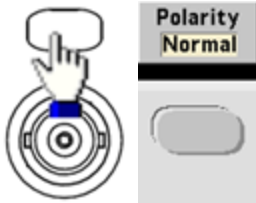

ou

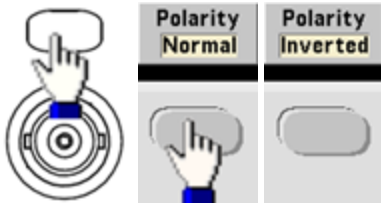

- SCPI:** `OUTPut[1|2]:POLarity {NORMal|INVerted}`

## Signal de sortie de synchronisation

Le connecteur **Sync** de la face avant fournit une sortie de synchronisation. Toutes les fonctions de sortie standard (sauf la tension continue et le bruit) sont associées à un signal de synchronisation **Sync**. Pour les applications dans lesquelles vous ne souhaitez pas envoyer le signal **Sync**, vous pouvez désactiver le connecteur **Sync**. Le signal **Sync** peut être dérivé de l'une des voies d'un instrument 2 voies.

### Comportement général

- Par défaut, le signal **Sync** est dérivé de la voie 1 et envoyé au connecteur **Sync** (activé).
- Lorsque le signal **Sync** est désactivé, le niveau de sortie sur le connecteur **Sync** est en logique « basse ».
- La polarité du signal **Sync** est spécifiée par la commande **OUTPut:SYNC:POLarity {INVerted|NORMal}**.
- L'inversion d'un signal (voir **Polarité des signaux**) n'entraîne pas l'inversion du signal **Sync** associé.
- Pour les signaux sinusoïdaux, carrés, triangulaires, les impulsions et les rampes, le signal **Sync** est un signal carré « haut » dans la première moitié du cycle et « bas » dans la deuxième moitié. Les tensions du signal **Sync** sont compatibles TTL lorsque son impédance de charge est supérieure à 1 k $\Omega$ .
- Pour les signaux arbitraires, le signal **Sync** monte au début du signal et chute au milieu. Vous pouvez ignorer ce comportement par défaut en utilisant la commande **MARKer:POINT** pour spécifier le point dans le signal arbitraire où le signal **Sync** passe à l'état « bas ».

### Modulation

- Pour des signaux AM, FM, PM et PWM modulés en interne, le signal **Sync** est normalement référencé sur le signal modulant (et non le signal porteur) et est un signal carré présentant un rapport cyclique de 50 %. Le signal **Sync** est au niveau TTL « haut » pendant la première moitié du signal modulant. Vous pouvez configurer le signal **Sync** pour suivre le signal porteur avec la commande **OUTPut:SYNC:MODE {CARRier|NORMal|MARKer}** lorsque la modulation est interne.
- Pour des signaux AM, FM, PM et PWM modulés en externe, le signal **Sync** est normalement référencé sur le signal porteur (et non le signal modulant) et est un signal carré présentant un rapport cyclique de 50 %.
- Vous pouvez ignorer le comportement normal du signal synchrone (**Sync**) pour le forcer à suivre le signal porteur **OUTPut[1|2]:SYNC:MODE CARRier**.
- Pour la modulation par déplacement de fréquence (FSK), le signal **Sync** est référencé sur la fréquence FSK. Le signal **Sync** est au niveau TTL « haut » lors de la transition vers la fréquence de saut.



## Balayage

- Le signal **Sync** est un signal TTL « haut » au début du balayage et « bas » au point médian du balayage. Le signal **Sync** est synchronisé avec le balayage, mais n'est pas égal au temps de balayage du fait que sa temporisation inclut le temps de réarmement.
- Pour les balayages de fréquence avec marqueur actif, le signal **Sync** est un signal TTL « haut » au début du balayage et « bas » à la fréquence du marqueur. Vous pouvez modifier ce paramètre à l'aide de la commande **OUTPut[1|2]:SYNC:MODE MARKER**.

## Rafale

- Pour une rafale déclenchée, le signal **Sync** est au niveau TTL « haut » au début de la rafale. Le signal **Sync** est au niveau TTL « bas » à la fin du nombre de cycles spécifié (il ne peut pas être le point de passage au zéro si le signal est associé à une phase initiale). Pour un nombre de cycles de rafale infini, le signal **Sync** est identique à un signal continu.
- Pour une rafale commandée en externe, le signal **Sync** suit le signal de déclenchement externe. Cependant, le signal ne passe pas au niveau TTL « bas » jusqu'à la fin du dernier cycle (il ne peut pas être le point de passage au zéro si le signal est associé à une phase initiale).

## Configuration de la sortie de synchronisation

- **Face avant :**

Pour activer et désactiver le signal **Sync** :

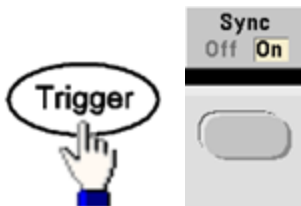

Pour configurer le signal Sync :

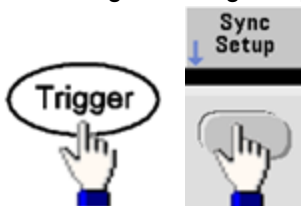

- **SCPI:**

**OUTPut:SYNC {ON|1|OFF|0}**

**OUTPut[1|2]:SYNC:MODE {NORMal|CARRier|MARKer}**

**OUTPut[1|2]:SYNC:POLarity {NORMal|INVerted}**

**OUTPut:SYNC:SOURce {CH1|CH2}**

## Trains d'impulsions

La figure ci-dessous illustre une impulsion ou un signal carré composé d'une période, d'une largeur d'impulsion, d'un front montant et d'un front descendant.

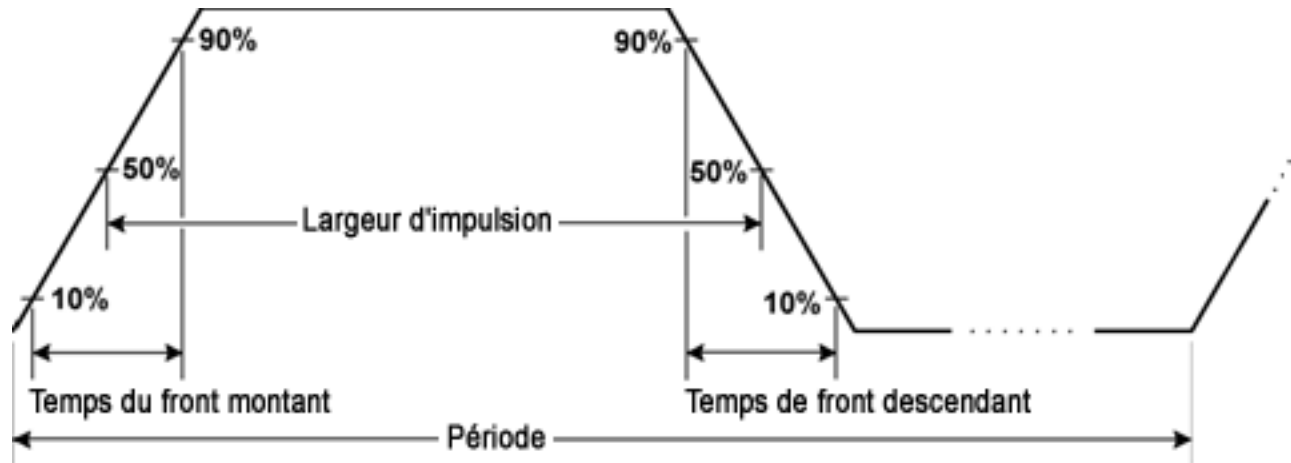

## Période

- Période : inverse de la fréquence maximale jusqu' 1 000 000 s (1 ms par défaut).
- L'instrument règle la largeur d'impulsion et les temps de front en fonction de la période spécifiée.
- **Face avant :**

Sélectionnez le train d'impulsions :

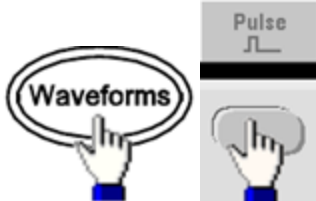

Sélectionnez la période à la place de la fréquence :



Définissez la période :

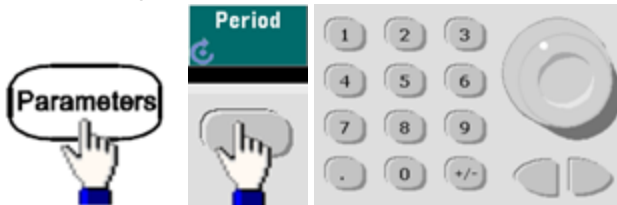

- **SCPI:** `[SOURce[1|2]:]FUNction:PULSe:PERiod {<secondes>|MINimum|MAXimum|DEFault}`

## Largeur d'impulsion

La largeur d'impulsion est le temps qui s'écoule entre le niveau de 50 % du front montant et le niveau de 50 % du front descendant suivant de l'impulsion.

- Largeur d'impulsion : jusqu'à 1 000 000 s (voir les limitations ci-dessous). Par défaut, la largeur d'impulsion est de 100  $\mu$ s. La largeur d'impulsion minimale est de 16 ns sur la série 33500, et de 5 ns jusqu'à 4 Vpp ou de 8 ns jusqu'à 10 Vpp sur la série 33600.
- La largeur d'impulsion spécifiée doit également être inférieure à la différence entre la période et la largeur d'impulsion minimale.
- L'instrument ajuste la largeur d'impulsion afin qu'elle tienne compte de la période spécifiée.

- Face avant :



- SCPI: `[SOURCE[1|2]:]FUNCTION:PULSE:WIDTH {<secondes>|MINimum|MAXimum|DEFAULT}`

### Rapport cyclique d'impulsion

Le rapport cyclique d'une impulsion se définit comme suit :

Rapport cyclique =  $100(\text{Largeur d'impulsion})/\text{Période}$

La largeur d'impulsion est le temps qui s'écoule entre le niveau de 50 % du front montant et le niveau de 50 % du front descendant suivant de l'impulsion.

- Rapport cyclique d'impulsion : 0,01 % à 99,99 % (voir les limitations ci-dessous). La valeur par défaut est de 10 %.
- Le rapport cyclique d'impulsion doit respecter les conditions suivantes imposées par la largeur d'impulsion minimale ( $W_{\min}$ ). L'instrument ajuste le rapport cyclique d'impulsion afin qu'il tienne compte de la période spécifiée.

Rapport cyclique  $> 100(\text{Largeur d'impulsion minimale})/\text{Période}$

et

Rapport cyclique  $< 100(1 - (\text{Largeur d'impulsion minimale} / \text{Période}))$

La largeur d'impulsion minimale est de 16 ns sur la série 33500, et de 5 ns jusqu'à 4 Vpp ou de 8 ns jusqu'à 10 Vpp sur la série 33600.

- Plus les fronts sont importants, plus la largeur d'impulsion est grande. Des fronts importants limitent donc le rapport cyclique.

- Face avant :

Sélectionnez la fonction Impulsion :

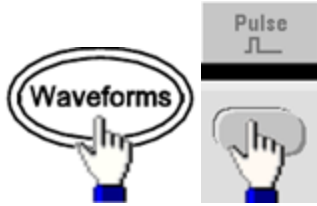

Activez le rapport cyclique :



Entrez le rapport cyclique :

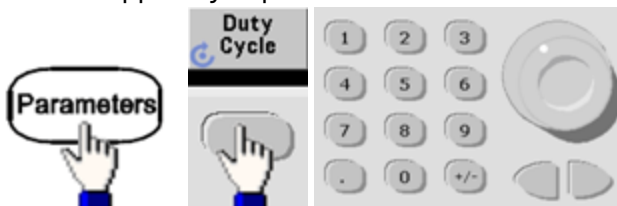

- SCPI: `[SOURce[1|2]:]FUNCTio:n:PULSe:DCYClE {<pourcentage>|MINimum|MAXimum|DEFault}`

## Temps de front

Les temps de front indiquent la durée des transitions des fronts montant et descendant de l'impulsion, indépendamment ou ensemble. Le temps de front représente le temps entre 10 % et 90 % du seuil.

- Temps de front : Minimum de 8,4 ns sur la série 33500, et 2,9 ns jusqu'à 4 Vpp, ou 3,3 ns jusqu'à 10 Vpp sur la série 33600. Maximum de 1 µs et valeur par défaut de 10 ns.
- Le temps de front spécifié doit être contenu dans la largeur d'impulsion spécifiée ([voir ci-dessus](#)). L'instrument ajuste le temps de front afin qu'il tienne compte de la largeur d'impulsion spécifiée.
- **Face avant :**

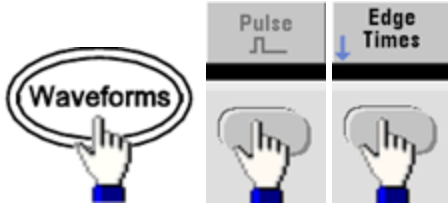

- **SCPI:**  
`[SOURCE[1|2]:]FUNCTION:PULSE:TRANSITION:LEADING {<secondes>|MINimum|MAXimum|DEFAULT}`  
`[SOURCE[1|2]:]FUNCTION:PULSE:TRANSITION:TRAILING {<secondes>|MINimum|MAXimum|DEFAULT}`  
`[SOURCE[1|2]:]FUNCTION:PULSE:TRANSITION[:BOTH] {<secondes>|MINimum|MAXimum|DEFAULT}`

## Modulation d'amplitude (AM) et modulation de fréquence (FM)

Un signal modulé se compose d'un signal porteur et d'un signal modulant. En modulation d'amplitude (AM), la tension du signal modulant fait varier l'amplitude du signal porteur. En modulation de fréquence (FM), la tension du signal modulant fait varier la fréquence du signal porteur. L'instrument accepte une source de modulation interne ou externe. Sur un instrument 2 voies, une voie peut moduler l'autre.

Sélectionnez AM ou FM avant de configurer un paramètre de modulation. Pour plus d'informations sur la modulation, reportez-vous à la section [Modulation](#).

### Pour sélectionner AM ou FM

- L'instrument permet d'activer un seul mode de modulation sur une voie. Lorsque vous activez AM ou FM, toute autre modulation est inactive. Sur les modèles 2 voies, les modulations des 2 voies sont indépendantes ; l'instrument peut ajouter des signaux modulés provenant des 2 voies. Pour de plus amples informations, voir [PHASE:SYNChronize](#) et [COMBine:FEED](#).
- L'instrument ne permet pas d'activer AM ou FM en mode balayage ou rafale. L'activation de la modulation (AM ou FM) entraîne la désactivation des modes balayage et rafale.
- Pour éviter plusieurs modifications des signaux, activez la modulation après avoir configuré les autres paramètres de modulation.

- Face avant :

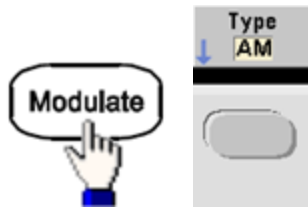

ou

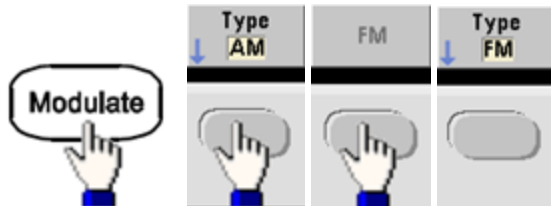

Activez ensuite la modulation :



Le signal est envoyé en utilisant les paramètres actuels du signal porteur et du signal modulant.

- SCPI:

`[SOURCE[1|2]:]AM:STATE{ON|1|OFF|0}`

`[SOURCE[1|2]:]FM:STATE {ON|1|OFF|0}`

### Forme du signal porteur

- Forme du signal porteur AM ou FM : sinusoïde, signal carré, rampe, triangle, impulsion, bruit (AM uniquement), PRBS ou signal arbitraire. Il n'est pas possible d'utiliser un courant continu comme signal porteur.
- Pour la modulation FM, la fréquence porteuse doit toujours être supérieure ou égale à la variation de fréquence. Toute tentative de configuration d'une variation supérieure à la fréquence porteuse provoque la configuration de la variation égale à la fréquence porteuse.
- La fréquence porteuse augmentée de la variation ne peut pas être supérieure à la fréquence maximale de la fonction sélectionnée plus 100 kHz. Si vous tentez de régler la variation sur une valeur incorrecte, l'instrument l'ajuste à la valeur maximale autorisée avec la fréquence porteuse active. L'interface distante génère également l'erreur « Data out of range ».
- Face avant :



Sélectionnez ensuite une forme de signal.



## Consignes d'utilisation

- **SCPI:**  
`[SOURce[1|2]:]FUNction <fonction>`

La commande **APPLy** configure un signal à l'aide d'une commande unique.

### Fréquence du signal porteur

La fréquence porteuse maximale varie selon la fonction, le modèle et la tension de sortie, comme indiqué **ici**. La fréquence par défaut est de 1 kHz pour toutes les fonctions autres que les signaux arbitraires. La « fréquence » d'un signal arbitraire est également définie à l'aide de la commande **FUNction:ARBitrary:SRATe**.

- **Face avant :**







- **SCPI:** `[SOURce[1|2]:]FREQuency {<fréquence>|MINimum|MAXimum|DEFault}`

La commande **APPLy** configure un signal à l'aide d'une commande unique.

## Forme du signal modulant

L'instrument accepte une source de modulation AM ou FM interne ou externe. Sur un instrument 2 voies, vous pouvez moduler les voies entre elles.

**REMARQUE** Vous ne pouvez pas moduler du bruit avec du bruit, un signal PRBS avec un signal PRBS ou un signal arbitraire avec un signal arbitraire.

- La forme du signal modulant (source interne) peut être :
  - Sinusoïdal
  - Signal carré avec un rapport cyclique de 50 % 
  - Rampe montante avec symétrie égale à 100% 
  - Signal triangulaire avec une symétrie de 50 % 
  - Rampe descendante avec symétrie égale à 0 % 
  - Bruit - bruit blanc gaussien
  - PRBS - Séquence binaire pseudo aléatoire (polynôme PN7)
  - Arb - Signal arbitraire

- Face avant :

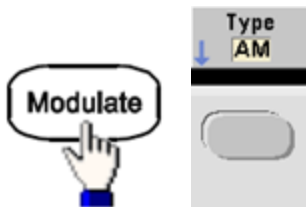

ou

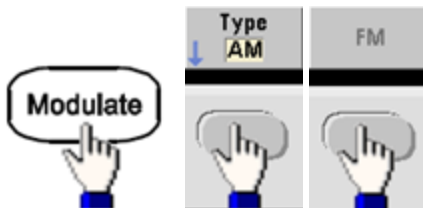

Sélectionnez ensuite la forme du signal modulant :



- SCPI:
  - `[SOURCE[1|2]:]AM:INTERNAL:FUNCTION <fonction>`
  - `[SOURCE[1|2]:]FM:INTERNAL:FUNCTION <fonction>`

## Fréquence du signal modulant

L'instrument accepte une source de modulation interne ou externe.

- Fréquence modulante (source interne) : La valeur minimale est de 1  $\mu$ Hz et les valeurs maximales varient selon le modèle, la fonction et la sortie, comme indiqué [ici](#).
- Fréquence modulante (source externe) : 0 à 100 kHz

- Face avant :



ou

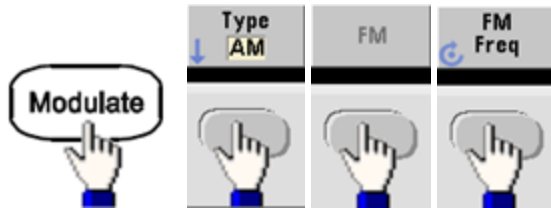

Entrez ensuite la fréquence AM ou FM à l'aide du bouton et du clavier :



- SCPI:

[SOURCE[1|2]:]AM:INTERNAL:FREQUENCY {<fréquence>|MINIMUM|MAXIMUM|DEFAULT}

[SOURCE[1|2]:]FM:INTERNAL:FREQUENCY {<fréquence>|MINIMUM|MAXIMUM|DEFAULT}

## Profondeur de modulation (AM)

La profondeur de modulation est un pourcentage qui représente la variation d'amplitude. Pour une profondeur de 0 %, l'amplitude est égale à la moitié de l'amplitude du signal porteur. Pour une profondeur de 100 %, l'amplitude varie en fonction du signal modulant, compris entre 0 % et 100 % de l'amplitude du signal porteur.

- Profondeur de modulation : 0 à 120 %. La valeur par défaut est 100 %.
- Même à une profondeur supérieure à 100 %, l'instrument ne dépasse pas  $\pm 5$  V en crête sur la sortie (dans une charge de 50  $\Omega$ ). Pour obtenir une profondeur de modulation supérieure à 100 %, l'amplitude du signal porteur peut être réduite.

- Face avant :

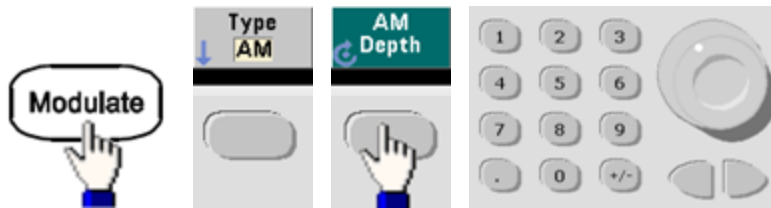

- SCPI: `[SOURCE[1|2]:]AM[:DEPTH] {<profondeur_en_pourcentage>|MINimum|MAXimum}`

## Signal porteur AM supprimé à double bande latérale

L'instrument prend en charge deux types de modulation d'amplitude : « Normal » et Signal porteur AM réduit à double bande latérale (DSSC). En mode DSSC, le signal porteur est absent à moins que l'amplitude du signal modulant soit positive.

- Face avant :



- SCPI: `[SOURCE[1|2]:]AM:DSSC{ON|OFF|0}`.

## Variation de fréquence (FM)

La variation de fréquence représente la variation en crête de la fréquence du signal modulé par rapport à la fréquence du signal porteur.

Lorsque le signal porteur est de type PRBS, la variation de fréquence entraîne une variation de la vitesse de transmission égale à la moitié de la fréquence réglée. Par exemple, une variation de 10 kHz est équivalente à une variation de 5 KBPS du débit binaire.

- Variation de fréquence : 1  $\mu$ Hz à (fréquence du signal porteur)/2, 100 Hz par défaut.
- Pour la modulation FM, la fréquence porteuse doit toujours être supérieure ou égale à la variation de fréquence. Toute tentative de configuration d'une variation supérieure à la fréquence porteuse provoque la configuration de la variation égale à la fréquence porteuse.
- La fréquence porteuse augmentée de la variation ne peut pas être supérieure à la fréquence maximale de la fonction sélectionnée plus 100 kHz. Si vous tentez de régler la variation sur une valeur incorrecte, l'instrument l'ajuste à la valeur maximale autorisée avec la fréquence porteuse active. L'interface distante génère également l'erreur « Data out of range ».

- **Face avant :**

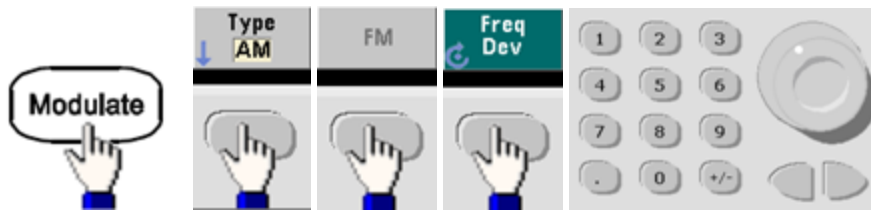

- **SCPI:** `[SOURce[1|2]:]FM[:DEVIation] {<variation_crête_en_Hz>|MINimum|MAXimum|DEFault}`

## Source modulante

L'instrument accepte une source de modulation interne ou externe. Sur un instrument 2 voies, vous pouvez moduler les voies entre elles.

**REMARQUE** Sur la série 33600, vous configurez la source modulante pour accepter un signal de  $\pm 5$  V ou de  $\pm 1$  V. Pour plus d'informations, voir [INPut:ATtenuation\[:STATe\]](#).

- Source modulante : Interne (par défaut), autre source ou externe. La fréquence de la source de modulation externe peut atteindre 100 kHz.
- Avec la source externe, un signal externe module le signal porteur. La profondeur de modulation (AM) ou la variation de fréquence (FM) est contrôlé par le niveau de signal sur le connecteur **Modulation In** de la face arrière. La bande passante à l'entrée de modulation externe est de -3 dB à 100 kHz.
- Exemple AM : avec une profondeur de modulation de 100 %, lorsque le signal modulant est à +5 V, l'amplitude de la sortie est maximale. Lorsque le signal modulant est à -5 V, l'amplitude de la sortie est minimale.
- Exemple FM : avec une variation de 10 kHz, un signal de +5 V correspond à une augmentation de fréquence de 10 kHz. Des signaux externes plus faibles produisent une variation moindre et les signaux négatifs réduisent la fréquence au-dessous de la fréquence porteuse.
- **Face avant :**  
Après avoir activé la modulation AM ou FM, sélectionnez la source modulante comme indiqué ci-dessous :



- **SCPI:**  
`[SOURce[1|2]:]AM:SOURce {INTernal|EXTernal|CH1|CH2}`  
`[SOURce[1|2]:]FM:SOURce {INTernal|EXTernal|CH1|CH2}`

## Modulation de phase (PM)

Un signal modulé se compose d'un signal porteur et d'un signal modulant. La modulation de phase (PM) est très similaire à la modulation de fréquence (FM). Cependant, dans la modulation de phase, la tension instantanée du signal modulant fait varier la phase du signal modulé.

Pour de plus amples informations sur les principes de base de la modulation de phase, reportez-vous à la section [Didacticiel - Modulation](#).

### Sélectionner la modulation de phase

- Vous ne pouvez activer qu'un seul mode de modulation à la fois. L'activation de la modulation de phase entraîne la désactivation du mode de modulation précédent.

## Consignes d'utilisation

- L'activation de la modulation de phase entraîne la désactivation des modes balayage et rafale.

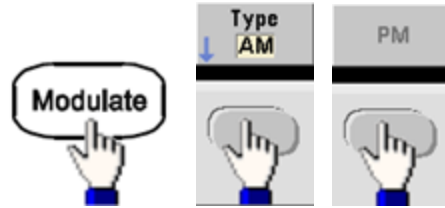

- **Face avant :**

Le signal est envoyé en utilisant les paramètres actuels du signal porteur et du signal modulant.

- Pour éviter plusieurs modifications des signaux, activez la modulation après avoir configuré les autres paramètres de modulation.
- **SCPI:** `[SOURce[1|2]:]PM:STATe {ON|1|OFF|0}`

## Forme du signal porteur

- Forme du signal porteur en modulation de phase (PM) : sinusoïdal (par défaut), signal carré, rampe, triangle, impulsion, PRBS ou signal arbitraire. Vous ne pouvez pas utiliser de bruit ou de courant continu comme signal porteur.



- **Face avant :**

Sélectionnez ensuite un type de signal, à l'exception de Bruit ou CC.

- **SCPI:** `[SOURce[1|2]:]FUNCTion <fonction>`
- La commande **APPLY** configure un signal à l'aide d'une commande unique.
- Lorsque le signal porteur est un signal arbitraire, la modulation a une incidence sur l'horloge d'échantillonnage à la place du cycle complet défini par l'ensemble d'échantillonnage du signal arbitraire. Pour cette raison, l'application de la modulation d'impulsion à des signaux arbitraires est limitée.

## Fréquence du signal porteur

La fréquence porteuse maximale varie selon la fonction, le modèle et la tension de sortie, comme indiqué [ici](#). La fréquence par défaut est de 1 kHz pour toutes les fonctions autres que les signaux arbitraires. La fréquence du signal porteur doit être 20 fois supérieure à la fréquence de modulation en crête.

- Face avant :

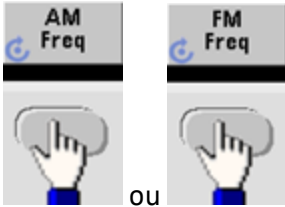

ou

ou n'importe quelle autre touche Frequency.

Après avoir sélectionné la touche Frequency :







- SCPI: `[SOURce[1|2]:]FREQuency {<fréquence>|MINimum|MAXimum|DEFault}`
- La commande **APPLY** configure un signal à l'aide d'une commande unique.



## Forme du signal modulant

L'instrument accepte une source de modulation interne ou externe.

- La forme du signal modulant (source interne) peut être :
  - Sinusoïdal
  - Signal carré avec un rapport cyclique de 50 % 
  - Rampe montante avec symétrie égale à 100% 
  - Signal triangulaire avec une symétrie de 50 % 
  - Rampe descendante avec symétrie égale à 0 % 
  - Bruit - bruit blanc gaussien
  - PRBS - Séquence binaire pseudo aléatoire (polynôme PN7)
  - Signal arbitraire
- Vous pouvez utiliser le bruit comme signal modulant. Cependant, vous ne pouvez pas utiliser le bruit ou le courant continu comme signal porteur.

- Face avant :

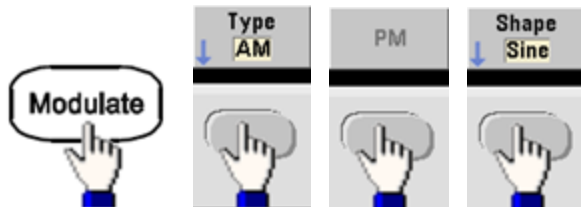

- SCPI: `[SOURce[1|2]:]PM:INTernal:FUNction <fonction>`

## Fréquence du signal modulant

L'instrument accepte une source de modulation interne ou externe. La bande passante à l'entrée de modulation externe est de -3 dB à 100 kHz.

- Fréquence modulante (interne) : 10 Hz par défaut, 1  $\mu$ Hz minimum ; la valeur maximale varie selon le modèle, la fonction et la tension de sortie, comme indiqué [ici](#).
- Face avant :

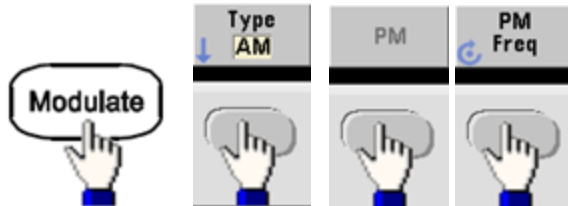

Définissez ensuite la fréquence du signal modulant :



- SCPI: `[SOURCE[1|2]:]PM:INTernal:FREQuency {<fréquence>|MINimum|MAXimum|DEFault}`

## Variation de phase

La variation de phase représente la variation en crête de la phase du signal modulé par rapport au signal porteur. La variation de phase peut être configurée entre 0 et 360 degrés (180 par défaut).

- **Face avant :**

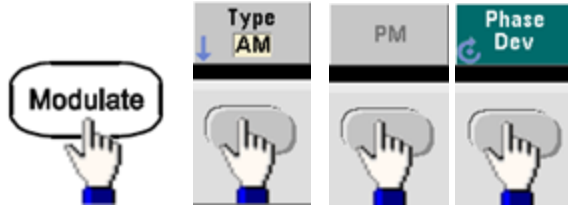

Définissez ensuite la variation de phase :



- **SCPI:** `[SOURce[1|2]:]PM:DEVIation {<variation en degrés>|MINimum|MAXimum|DEFault}`
- Lorsque le signal porteur est un signal arbitraire, la variation s'applique à l'horloge d'échantillonnage. Par conséquent, l'impact sur l'intégralité du signal arbitraire est beaucoup moins important que celui observé sur les signaux standard. La réduction de cet impact dépend du nombre de points contenus dans le signal arbitraire.

## Source modulante

L'instrument accepte une source de modulation interne ou externe.

- Source modulante : Interne (par défaut), autre source ou externe. La fréquence de la source de modulation externe peut atteindre 100 kHz.
- Avec la source externe, un signal externe module le signal porteur. Le signal de  $\pm 5$  V sur le connecteur **Modulation In** de la face arrière contrôle la variation de phase. Par exemple, si la variation est définie à 180 degrés, un signal de +5 V correspond à un déphasage de 180 degrés. Des tensions inférieures engendrent une variation inférieure.

- **Face avant :**

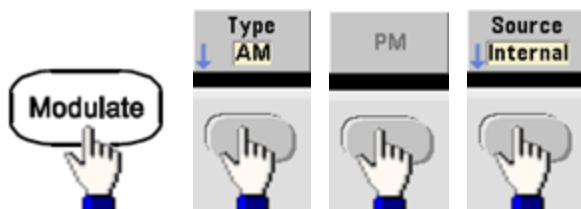

- **SCPI:** `[SOURce[1|2]:]PM:SOURce {INTernal|EXTernal|CH1|CH2}`

## Modulation par déplacement de fréquence (FSK)

Vous pouvez configurer l'instrument pour « faire dériver » sa fréquence de sortie entre deux valeurs prédéfinies (appelées « fréquence porteuse » et « fréquence de saut ») à l'aide de la commande **FSK modulation**. La vitesse de dérive de la sortie entre ces deux fréquences est déterminée par le générateur de fréquences interne ou le niveau de signal sur le connecteur **Ext Trig** de la face arrière.

Pour plus d'informations sur la modulation FSK à l'aide de la face avant, reportez-vous à la section **Utilisation des menus de la face avant - Envoyer un signal FSK**.

### Sélectionner la modulation FSK

**FSKey:STATe {OFF|ON}**

- Vous ne pouvez activer qu'un seul mode de modulation à la fois. L'activation de la modulation FSK entraîne la désactivation du mode de modulation précédent.
- Il n'est pas possible d'activer la modulation FSK lorsque le mode balayage ou rafale est activé. L'activation de la modulation FSK entraîne la désactivation des modes balayage et rafale.
- Pour éviter plusieurs modifications des signaux, activez la modulation après avoir configuré les autres paramètres de modulation.

### Fréquence du signal porteur FSK

**[SOURce[1|2]:]FREQuency {<fréquence>|MINimum|MAXimum|DEFault}**

La fréquence porteuse maximale varie selon la fonction, le modèle et la tension de sortie, comme indiqué **ici**. La fréquence par défaut est de 1 kHz pour toutes les fonctions autres que les signaux arbitraires.

- Lorsque la source externe (EXternal) est sélectionnée, la fréquence de sortie est déterminée par le niveau du signal sur le connecteur **Ext Trig** de la face arrière. Lorsque le niveau logique est bas, la fréquence porteuse est envoyée. Lorsque le niveau logique est haut, la fréquence de saut est envoyée.

## Fréquence de saut FSK

[SOURCE[1|2]:]FSKey:FREQUENCY {<fréquence>|MINimum|MAXimum|DEFAULT}

La fréquence secondaire (saut) maximale dépend de la fonction utilisée. La fréquence par défaut est de 100 Hz pour toutes les fonctions. Le signal modulant interne est un signal carré présentant un rapport cyclique de 50 %.

Fonction	Fréquence de saut minimale	Fréquence de saut maximale
Sinusoïdal	1 µHz	(varie selon le modèle, comme indiqué <a href="#">ici</a> )
Carré		
Rampe/triangle		
Impulsion		

- Lorsque la source externe (EXTERNAL) est sélectionnée, la fréquence de sortie est déterminée par le niveau du signal sur le connecteur **Ext Trig** de la face arrière. Lorsque le niveau logique est bas, la fréquence porteuse est envoyée. Lorsque le niveau logique est haut, la fréquence de saut est envoyée.

## Fréquence de cadencement FSK

[SOURCE[1|2]:]FSKey:INTERNAL:RATE {<fréquence\_en\_Hz>|MINimum|MAXimum}

La fréquence de cadencement FSK définit la cadence à laquelle la fréquence de sortie alterne entre la fréquence du signal porteur et la fréquence de saut lors de l'utilisation de la source interne de modulation FSK.

- Fréquence de cadencement FSK (source interne) : 125 µHz (série 33500) ou 250 µHz (série 33600) jusqu'à 1 MHz, 10 Hz par défaut.
- La fréquence de cadencement FSK est ignorée lorsque la source de modulation externe FSK est sélectionnée.

## Source FSK

[SOURCE[1|2]:]FSKey:SOURCE {INTERNAL|EXTERNAL}

Peut être interne (par défaut) ou externe.

- Lorsque la source interne est sélectionnée, la vitesse à laquelle la fréquence de sortie alterne entre la fréquence du signal porteur et la fréquence de saut est déterminée par la fréquence de cadencement FSK. Le signal modulant interne est un signal carré présentant un rapport cyclique de 50 %.
- Lorsque la source externe (EXTERNAL) est sélectionnée, la fréquence de sortie est déterminée par le niveau du signal sur le connecteur **Ext Trig** de la face arrière. Lorsque le niveau logique est bas, la fréquence porteuse est envoyée. Lorsque le niveau logique est haut, la fréquence de saut est envoyée.
- Le connecteur utilisé pour les signaux FSK déclenchés extérieurement (**Ext Trig**) n'est pas le même que celui des signaux modulés en externe AM, FM, PM et PWM (**Modulation In**). Lorsqu'il est utilisé pour la modulation FSK, le connecteur **Ext Trig** ne permet pas le réglage de la polarité des fronts.

## Modulation de largeur d'impulsion (PWM)

Cette section décrit la modulation de largeur d'impulsion (PWM). La modulation PWM est disponible uniquement pour un train d'impulsions ; la largeur d'impulsion varie en fonction du signal modulant. L'importance de variation d'une largeur d'impulsion est appelée variation de largeur ; elle peut être spécifiée en pourcentage de la période du signal (rapport cyclique) ou en unité de temps. Par exemple, si vous spécifiez une impulsion avec un rapport cyclique de 20 % et activez ensuite la modulation PWM avec une variation de 5 %, le rapport cyclique varie entre 15 % et 25 % sous le contrôle du signal modulant.

L'instrument accepte une source de modulation interne ou externe.

### Sélectionner la modulation de largeur d'impulsion (PWM)

- Il n'est pas possible d'activer la modulation PWM lorsque le mode balayage ou rafale est activé.
- Pour éviter plusieurs modifications des signaux, activez la modulation après avoir configuré les autres paramètres de modulation.
- **Face avant :**

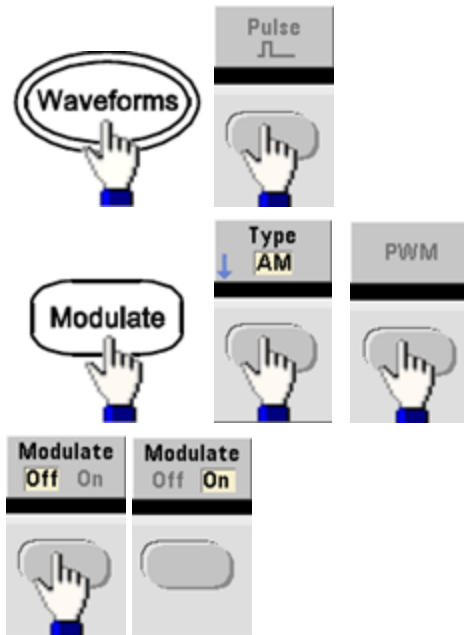





Le signal est envoyé en utilisant les paramètres actuels du signal porteur et du signal modulant.

- **SCPI:** `[SOURce[1|2]:]PWM:STATe {ON|1|OFF|0}`

## Forme du signal modulant

L'instrument accepte une source de modulation interne ou externe.

- La forme du signal modulant (source interne) peut être :
  - Sinusoïdal
  - Signal carré avec un rapport cyclique de 50 % 
  - Rampe montante avec symétrie égale à 100% 
  - Signal triangulaire avec une symétrie de 50 % 
  - Rampe descendante avec symétrie égale à 0 % 
  - Bruit - bruit blanc gaussien
  - PRBS - Séquence binaire pseudo aléatoire (polynôme PN7)
  - Signal arbitraire
- **Face avant :**

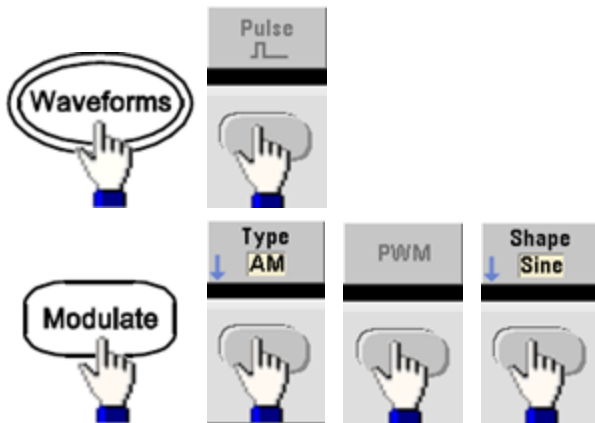

- SCPI: `[SOURce[1|2]:]PWM:INTernal:FUNction <fonction>`

## Fréquence du signal modulant

L'instrument accepte une source de modulation interne ou externe. La bande passante à l'entrée de modulation externe est de -3 dB à 100 kHz.

- Fréquence modulante (source interne) : La valeur par défaut est 10 Hz et la valeur minimale est de 1  $\mu$ Hz. La fréquence maximale varie selon la fonction, le modèle et la tension de sortie, comme indiqué [ici](#).
- Face avant :

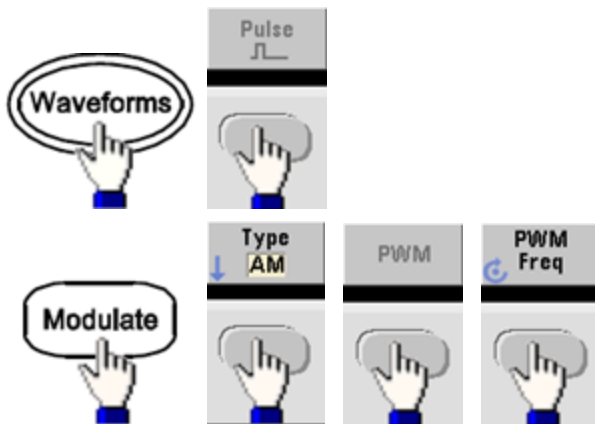

- SCPI: `[SOURce[1|2]:]PWM:INTernal:FREQuency {<fréquence>|MINimum|MAXimum|DEFAULT}`



## Variation de la largeur ou du rapport cyclique

La variation PWM est la variation de largeur en crête de l'impulsion modulée. L'unité de ce paramètre peut être le temps ou le rapport cyclique.

- **Face avant :**

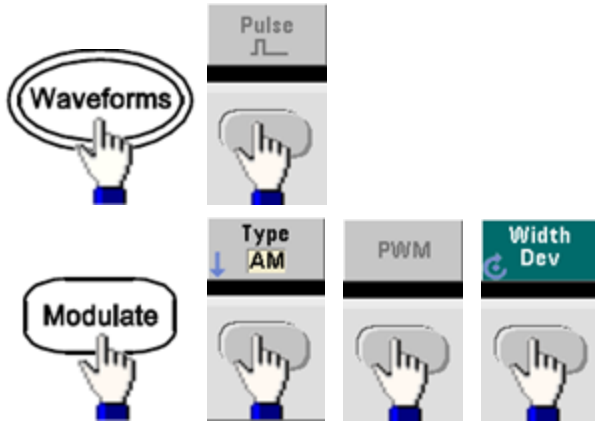

Pour configurer la variation exprimée en rapport cyclique :

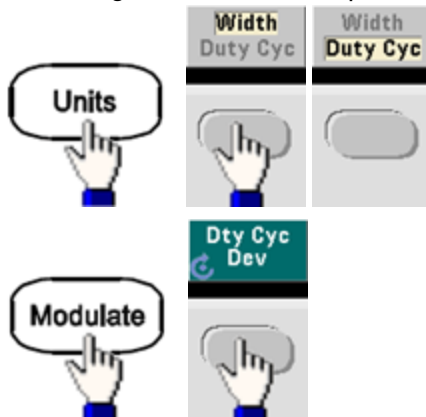

- **SCPI:** `[SOURce[1|2]:]PWM:DEVIation {<variation>|MINimum|MAXimum|DEFault}`
- La somme de la largeur d'impulsion et de la variation doit correspondre à la formule suivante :

Largeur d'impulsion + Variation < Période – 16 ns (série 33500)

Largeur d'impulsion + Variation < Période – 8 ns (série 33600 au-delà de 4 Vpp)

Largeur d'impulsion + Variation < Période – 5 ns (série 33600 jusqu'à 4 Vpp compris)

- Si nécessaire, l'instrument ajuste la variation afin qu'elle tienne compte de la période spécifiée.

## Source modulante

L'instrument accepte une source de modulation interne ou externe.

- Source modulante : Interne (par défaut), autre source ou externe. La fréquence de la source de modulation externe peut atteindre 100 kHz.
- Si vous sélectionnez la source modulante *externe*, la variation est contrôlée par le signal  $\pm 5$  V (éventuellement  $\pm 1$  V sur la série 33600) présent sur le connecteur **Modulation In** de la face arrière. Par exemple, si vous avez défini la variation à 1  $\mu$ s, un signal de +5 V (éventuellement de + 1 V sur la série 33600) correspond à une augmentation de 1  $\mu$ s de la largeur. Des tensions inférieures produisent une variation inférieure.
- **Face avant :**

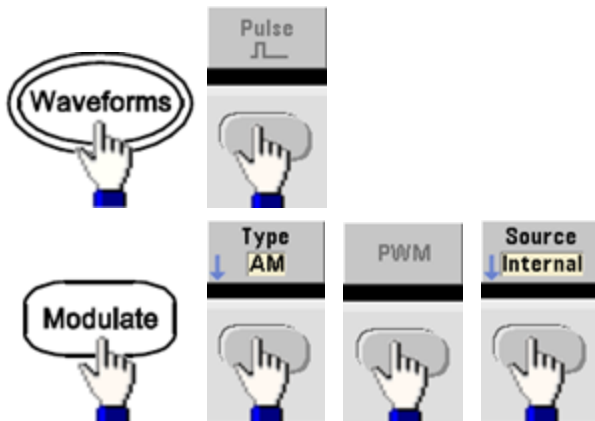

- SCPI: `[SOURce[1|2]:]PWM:SOURce {INTernal|EXTernal|CH1|CH2}`

## Train d'impulsions

- L'impulsion est la seule forme de signal prise en charge pour la modulation PWM.
- **Face avant :**

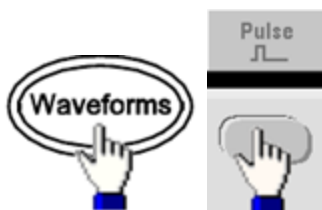

- SCPI: `FUNCTION PULSE`
- La commande `APPLY` configure un signal à l'aide d'une commande unique.

## Période d'impulsion

La plage de la période d'impulsion est l'inverse de la fréquence maximale de l'instrument jusqu'à 1 000 000 s (100 µs par défaut). Notez que la période du signal limite la variation maximale.

- Face avant :

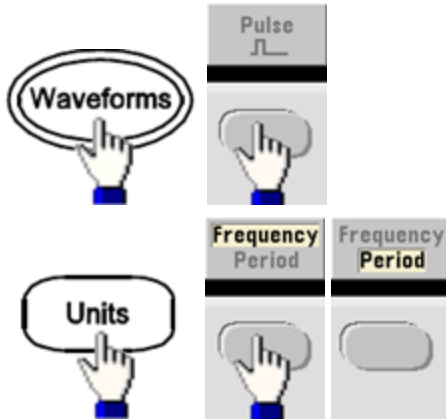

- SCPI: `[SOURce[1|2]:]FUNCTion:PULSE:PERiod {<secondes>|MINimum|MAXimum|DEFault}`

## Modulation par addition

La fonction de modulation SUM permet d'ajouter un signal modulant à un signal porteur. On l'utilise généralement pour ajouter du bruit gaussien à un signal porteur. Le signal modulant est ajouté au signal porteur en tant que pourcentage de l'amplitude du signal porteur.

### Activer la fonction Sum

- Pour éviter plusieurs modifications des signaux, activez la fonction Sum après avoir configuré les autres paramètres de modulation.

- Face avant :

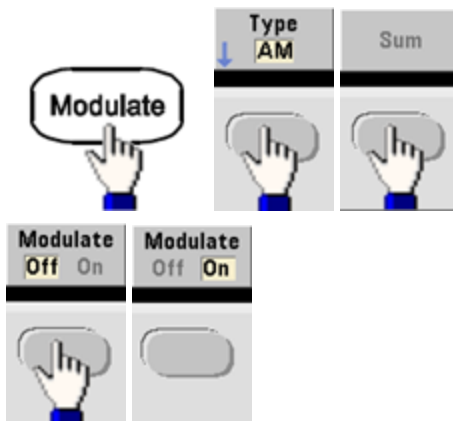

- SCPI: `[SOURce[1|2]:]SUM:STATe {ON|1|OFF|0}`

## Forme du signal modulant

L'instrument accepte une source de modulation interne ou externe. Sur un instrument 2 voies, vous pouvez moduler les voies entre elles.

- La forme du signal modulant (source interne) peut être :

- Sinusoïdal

- Signal carré avec un rapport cyclique de 50 % 

- Rampe montante avec symétrie égale à 100% 

- Signal triangulaire avec une symétrie de 50 % 

- Rampe descendante avec symétrie égale à 0 % 

- Bruit

- PRBS avec séquence PN7

- Signal arbitraire

- Face avant :

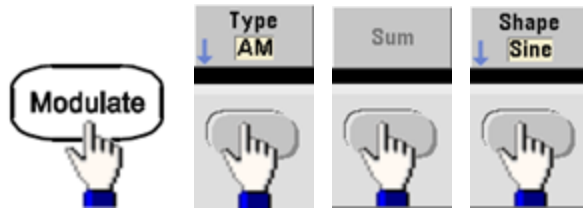

- SCPI: `[SOURce[1|2]:]SUM:INTernal:FUNction <fonction>`

## Fréquence du signal modulant

L'instrument accepte une source de modulation interne ou externe. Sur un instrument 2 voies, vous pouvez moduler les voies entre elles.

- Fréquence modulante (source interne) : La valeur par défaut est 100 Hz et la valeur minimale est 1  $\mu$ Hz. La fréquence maximale varie selon la fonction, le modèle et la tension de sortie, comme indiqué [ici](#).

- Face avant :



- SCPI: `[SOURce[1|2]:]SUM:INTernal:FREQuency {<fréquence>|MINimum|MAXimum|DEFault}`

## Amplitude du signal Sum

L'amplitude du signal Sum représente l'amplitude du signal ajouté au signal porteur (en pourcentage de l'amplitude du signal porteur).

- Paramètre d'amplitude : 0 à 100 % de l'amplitude du signal porteur, résolution de 0,01 %.
- L'amplitude du signal Sum demeure une fraction constante de l'amplitude du signal porteur et suit ses variations.
- **Face avant :**

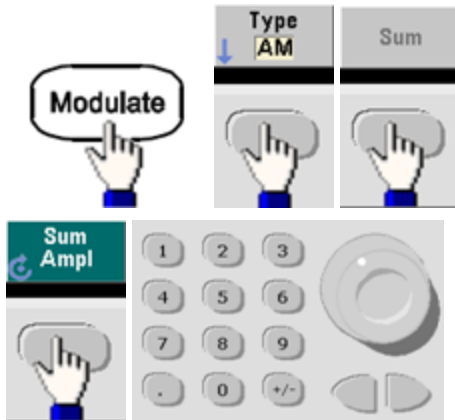

- **SCPI:** `[SOURCE[1|2]:]SUM:AMPLitude {<amplitude>|MINimum|MAXimum|DEFault}`

## Source modulante

L'instrument accepte une source de modulation interne ou externe. Sur un instrument 2 voies, vous pouvez moduler les voies entre elles.

- Source modulante : Interne (par défaut), autre source ou externe. La fréquence de la source de modulation externe peut atteindre 100 kHz.
- Avec une source externe, le signal de  $\pm 5$  V (éventuellement  $\pm 1$  V sur la série 33600) présent sur le connecteur **Modulation In** de la face arrière est ajouté au signal porteur. Par exemple, si vous avez défini l'amplitude du signal Sum à 10 %, lorsque le signal modulant est à +5 V (éventuellement à +1 V sur la série 33600), la sortie est l'amplitude maximale (110 % de l'amplitude du signal porteur). Lorsque le signal modulant est à -5 V (éventuellement à -1 V sur la série 33600), l'amplitude de la sortie est minimale (90 % de l'amplitude du signal porteur).

**REMARQUE** Si vous utilisez l'autre voie comme source de modulation SUM, envisagez plutôt d'utiliser **la fonction Combine**. Cette fonction comporte moins de restrictions et un retard moins important que SUM sur une autre voie.

- Face avant :

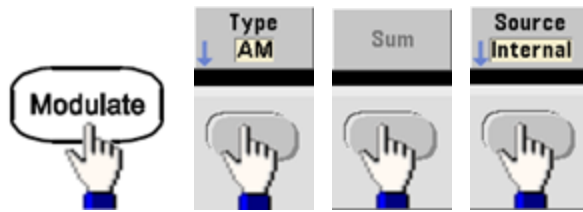

- SCPI: `[SOURce[1|2]:]SUM:SOURce {INTernal|EXTernal|CH1|CH2}`

## Balayage en fréquence

En mode balayage de fréquence, l'instrument passe de la fréquence initiale à la fréquence finale à une vitesse de balayage spécifiée. Vous pouvez effectuer un balayage en fréquence croissant ou décroissant, selon une logique linéaire ou logarithmique. Vous pouvez également configurer l'instrument pour envoyer un balayage de la fréquence initiale à la fréquence finale en appliquant un déclencheur externe ou manuel. L'instrument peut balayer des signaux sinusoïdaux, carrés, triangulaires ou arbitraires (les signaux PRBS et CC et le bruit ne sont pas autorisés).

Vous pouvez spécifier un temps de maintien pendant lequel le balayage reste à la fréquence finale, ainsi qu'un temps de retour pendant lequel la fréquence change linéairement de la fréquence finale à la fréquence initiale.

Pour plus d'informations, reportez-vous à la section **Balayage en fréquence**.

### Pour sélectionner le balayage

L'instrument n'autorise pas l'activation du mode balayage ou liste lorsque le mode rafale ou un mode de modulation est activé. Lorsque vous activez le balayage, le mode rafale ou modulation est désactivé.

- Pour éviter plusieurs modifications des signaux, activez le mode balayage après avoir configuré les autres paramètres.

## Consignes d'utilisation

- **Face avant :**



- **SCPI:**

[SOURCE[1|2]:]FREQUENCY:MODE SWEEP

[SOURCE[1|2]:]SWEep:STATe {ON|1|OFF|0}

## Fréquences initiale et finale

Les fréquences initiale et finale définissent les limites supérieure et inférieure du balayage. Le balayage commence à la fréquence initiale, balaie jusqu'à la fréquence finale et revient ensuite à la fréquence initiale.

- Fréquences initiale et finale : 1  $\mu$ Hz à la **fréquence maximale du signal**. La phase du balayage est continue sur l'ensemble de la plage des fréquences. La fréquence initiale par défaut est de 100 Hz. La fréquence finale par défaut est de 1 kHz.
- Pour balayer en fréquence vers le haut, définissez une fréquence initiale inférieure à la fréquence finale. Pour balayer en fréquence vers le bas, inversez cette relation.
- Sync Normal : l'impulsion **Sync** est haute au cours du balayage.
- Sync signal porteur : le rapport cyclique de l'impulsion **Sync** est égal à 50 % pour chaque cycle du signal.
- Sync marqueur : l'impulsion **Sync** monte au début et baisse à la fréquence du marqueur. Vous pouvez modifier ce paramètre à l'aide de la commande **OUTPUT[1|2]:SYNC:MODE MARKER**.
- **Face avant :**

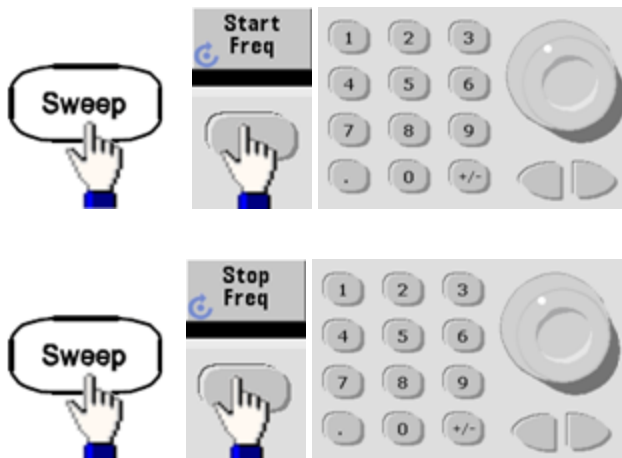

- **SCPI:**  
`[SOURCE[1|2]:]FREQUENCY:START {<fréquence>|MINimum|MAXimum|DEFAULT}`  
`[SOURCE[1|2]:]FREQUENCY:STOP {<fréquence>|MINimum|MAXimum|DEFAULT}`



## Fréquence médiane et plage de fréquences

Vous pouvez également configurer les limites de la fréquence de balayage en utilisant une fréquence médiane et une plage de fréquences. Ces paramètres similaires aux fréquences initiale et finale (ci-dessus) offrent une plus grande souplesse.

- Fréquence médiane : 1  $\mu$ Hz à la **fréquence maximale du signal**. La valeur par défaut est de 550 Hz.
- Plage de fréquence : toute valeur comprise entre  $\pm$ la **fréquence maximale du signal**. La valeur par défaut est de 900 Hz.
- Pour balayer en fréquences croissantes, définissez une plage de fréquences positives ; pour balayer en fréquences décroissantes, définissez une plage de fréquences négatives.
- Sync Normal : L'impulsion **Sync** est élevée au cours du balayage.
- Sync signal porteur : le rapport cyclique de l'impulsion **Sync** est de 50 % pour chaque cycle du signal.
- Sync marqueur : l'impulsion **Sync** monte au début et baisse à la fréquence du marqueur. Vous pouvez modifier ce paramètre à l'aide de la commande **OUTPut[1|2]:SYNC:MODE MARKER**.
- **Face avant :**

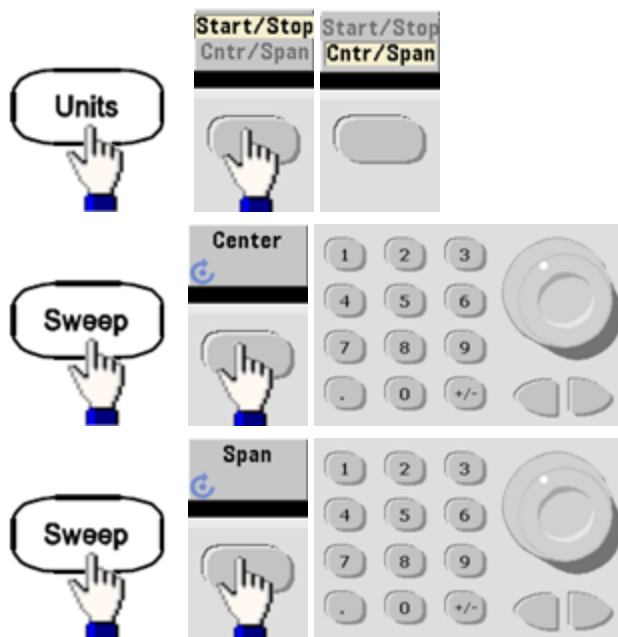

- **SCPI:**  
`[SOURCE[1|2]:]FREQUENCY:CENTer {<fréquence>|MINimum|MAXimum|DEFAULT}`  
`[SOURCE[1|2]:]FREQUENCY:SPAN {<fréquence>|MINimum|MAXimum|DEFAULT}`

## Mode balayage

Vous pouvez effectuer un balayage en fréquence linéaire ou selon une loi logarithmique, ou utiliser une liste de fréquences. Pour un balayage linéaire, l'instrument fait varier linéairement la fréquence de sortie pendant le balayage. Un balayage logarithmique fait varier la fréquence selon une loi logarithmique.

Le mode sélectionné n'affecte pas le retour du balayage (du début au début si le retour est configuré). Le retour du balayage est toujours linéaire.

- Face avant :

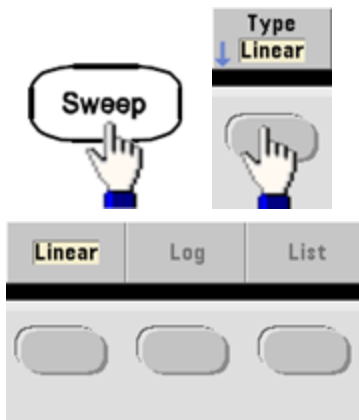

- SCPI: `[SOURce[1|2]:]SWEep:SPACing {LINear|LOGarithmic}`

## Temps de balayage

Le temps de balayage indique la durée (en secondes) du balayage entre la fréquence initiale et la fréquence finale. L'instrument calcule le nombre de points dans le balayage en fonction du temps de balayage.

- Temps de balayage : 1 ms à 250 000 secondes, 1 s par défaut. Pour un balayage linéaire en mode de déclenchement immédiat, le temps total maximal de balayage (y compris le temps de maintien et le temps de retour) est de 8 000 s. Le temps total maximal de balayage pour les balayages linéaires dans les autres modes de balayage est de 250 000 s ; le temps total maximal de balayage pour les balayages logarithmiques est de 500 s.

- Face avant :



- SCPI: `[SOURce[1|2]:]SWEep:TIME {<secondes>|MINimum|MAXimum|DEFault}`

## Temps de maintien/retour

Le temps de maintien spécifie le temps (en secondes) où la fréquence finale se maintient ; le temps de retour indique le temps (en secondes) pour revenir de la fréquence finale à la fréquence initiale.

- Temps de maintien et temps de retour : 0 à 3 600 secondes (0 par défaut).

- Face avant :

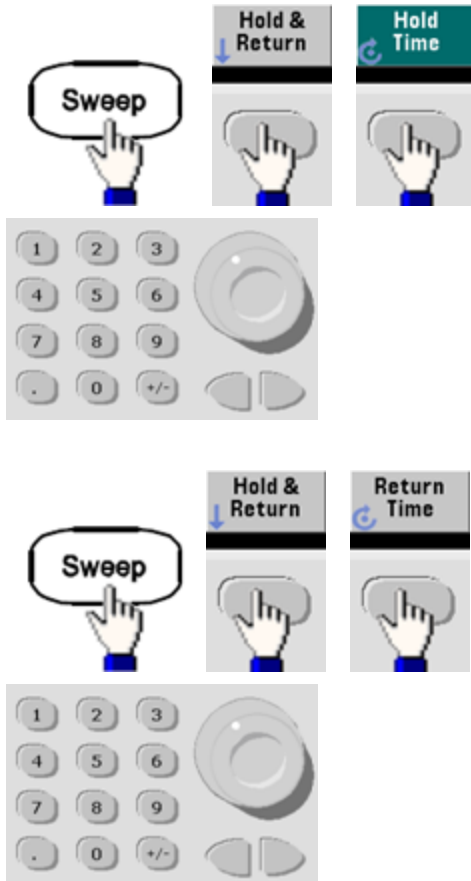

- SCPI:

`[SOURCE[1|2]:]SWEep:HTIME {<temps_maintien>|MINimum|MAXimum|DEFAULT}`

`[SOURCE[1|2]:]SWEep:RTIME {<temps_retour>|MINimum|MAXimum|DEFAULT}`

## Fréquence de marqueur

Vous pouvez éventuellement définir la fréquence à laquelle le signal sur le connecteur **Sync** de la face avant passe à l'état logique bas pendant le balayage. Le signal **Sync** passe toujours de l'état bas à l'état haut au début du balayage.

- Fréquence de marqueur : 1  $\mu$ Hz à la **fréquence maximale du signal**. La valeur par défaut est de 500 Hz.
- Lorsque le mode balayage est activé, la fréquence de marqueur doit être comprise entre les fréquences initiale et finale spécifiées. Si vous tentez de la définir en dehors de cette plage, l'instrument la renvoie à la fréquence initiale ou finale (celle qui est la plus proche).
- Vous ne pouvez pas configurer la fréquence de marqueur avec les menus de la face avant, sauf si la source **Sync** est la voie qui effectue le balayage.
- **Face avant :**

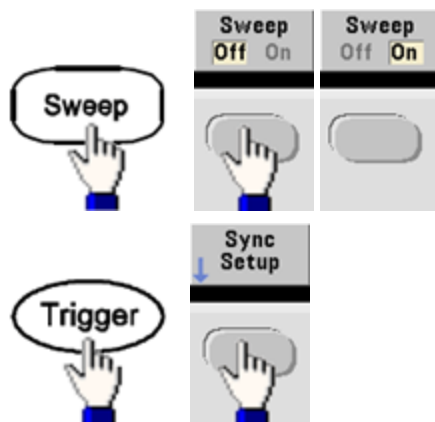

- **SCPI:** `[SOURce[1|2]:]MARKer:FREQuency {<fréquence>|MINimum|MAXimum|DEFault}`

## Source de déclenchement du balayage

En mode balayage, l'instrument envoie un balayage lorsqu'il reçoit un signal de déclenchement. Après un balayage de la fréquence initiale à la fréquence finale, l'instrument attend le déclenchement suivant pendant l'envoi de la fréquence initiale.

- Source de déclenchement du balayage : Immédiate (par défaut), Externe, Temps ou Manuelle.
- Avec la source immédiate (interne), l'instrument envoie un balayage continu à une fréquence déterminée par le temps total comprenant le temps de maintien, le temps de balayage et le temps de retour. Le temps de balayage de cette source est limité à 8 000 secondes.
- Avec la source externe, l'instrument accepte un déclencheur matériel sur le connecteur Ext Trig de la face arrière et lance un balayage chaque fois que ce connecteur Ext Trig reçoit une impulsion TTL avec la polarité spécifiée.
- La période du déclenchement doit être supérieure ou égale au temps de balayage spécifié.
- Avec la source manuelle, l'instrument envoie un balayage chaque fois que la touche **[Trigger]** de la face avant est enfoncée.

- **Face avant :**



- Pour spécifier la pente du front du signal de déclenchement :



- **SCPI:**

`TRIGger[1|2]:SOURce {IMMediate|EXTernal|TIMer|BUS}`

`TRIGger[1|2]:SLOPe {POSitive|NEGative}`

Pour plus d'informations, reportez-vous à la section [Déclenchements](#).

## Signal de sortie du déclenchement (Trigger Out)

Un signal de sortie de déclenchement (trigger out) est fourni sur le connecteur **Ext Trig** de la face arrière (utilisé uniquement en mode rafale et balayage). Lorsqu'il est activé, une impulsion avec un front montant (par défaut) ou un front descendant est envoyée depuis ce connecteur au début du balayage ou de la rafale.

- Lorsque la source de déclenchement immédiate (interne) est sélectionnée, l'instrument envoie un signal carré doté d'un rapport cyclique de 50 % à partir du connecteur **Ext Trig** au début du balayage ou de la rafale. La fréquence du signal correspond à la période de la rafale ou au temps total de balayage spécifiés.
- Lorsque la source de déclenchement externe est sélectionnée, l'instrument désactive le signal « trigger out ». Le connecteur **Ext Trig** ne peut pas être utilisé simultanément pour les balayages ou les rafales et la sortie de déclenchement (un signal déclenché en externe utilise le même connecteur pour déclencher la rafale ou le balayage).
- Lorsque la source de déclenchement Manuel ou Bus (logiciel) est sélectionnée, l'instrument envoie une impulsion (largeur de  $> 1 \mu\text{s}$  sur la série 33500 et de 100 ns sur la série 33600) à partir du connecteur **Ext Trig** au début de chaque balayage ou rafale.
- Pour indiquer si l'instrument se déclenche sur le front montant ou descendant du connecteur **Ext Trig**, appuyez sur **[Trigger] > Trig Out Setup**. Appuyez ensuite sur **Trig Out** pour sélectionner le front désiré.
- **SCPI:**  
`OUTPut:TRIGger:SLOPe {POSitive|NEGative}`  
  
`OUTPut:TRIGger {ON|1|OFF|0}`

## Liste de fréquences

En mode liste de fréquence, l'instrument « parcourt » une liste de fréquences, en restant sur chaque fréquence pendant une période donnée. Vous pouvez également contrôler la progression dans la liste avec un déclenchement.

- L'instrument n'autorise pas l'activation du mode balayage ou liste lorsque le mode rafale ou un mode de modulation est activé. Lorsque vous activez le balayage, le mode rafale ou modulation est désactivé.
- Pour éviter plusieurs modifications des signaux, activez le mode liste après avoir configuré ses paramètres.
- **Face avant :** Activez la liste avant de configurer les autres paramètres de la liste. Appuyez sur [Sweep] > Type > List.
- **SCPI:**  
`[SOURcd[1|2]:]FREQuency:MODE LIST`  
  
`[SOURce[1|2]:]LIST:FREQuency <fréq1>[, <fréq2>, etc.]`
- Le circuit de déclenchement contrôle la progression dans la liste. Si la source de déclenchement est interne ou immédiate, la durée des paliers `LIST:DWELL`) détermine le temps passé pour chaque fréquence. Pour les autres sources de déclenchement, la durée des paliers est déterminée par l'intervalle de déclenchement.

## Mode rafale

L'instrument peut envoyer pendant un nombre spécifié de cycles un signal appelé rafale. Les rafales sont autorisées avec des signaux sinusoïdaux, carrés, triangulaires, PRBS, des rampes, des impulsions ou des signaux arbitraires (le bruit est autorisé uniquement en mode rafale commandée ; le courant continu n'est pas autorisé).

Pour plus d'informations, reportez-vous à la section [Didacticiel - Rafale](#).

### Pour sélectionner le mode rafale

Il n'est pas possible d'activer une rafale lorsque le mode balayage ou modulation est activé. L'activation du mode rafale entraîne la désactivation du balayage et de la modulation.

- Pour éviter plusieurs modifications des signaux, activez le mode rafale après avoir configuré les autres paramètres.
- **Face avant :**



- **SCPI:** `[SOURce[1|2]:]BURSt:STATe {ON|1|OFF|0}`

## Mode rafale

Il existe deux modes rafale, décrits ci-dessous. Le mode sélectionné contrôle la source de déclenchement et les autres paramètres qui s'appliquent.

- **Mode rafale commandée (par défaut)** : L'instrument envoie un signal pendant un nombre spécifié de cycles (nombre de salves) chaque fois que le signal déclencheur est reçu. Après avoir envoyé ce nombre de cycles, l'instrument s'arrête et attend le déclenchement suivant. L'instrument peut utiliser un signal déclencheur interne pour démarrer la rafale. Vous pouvez également effectuer un déclenchement externe en appuyant sur la touche **[Trigger]** de la face avant, en appliquant le signal déclencheur sur le connecteur **Ext Trig** de la face arrière ou en envoyant une commande de déclenchement via le logiciel de l'interface distante.
- **Mode rafale commandée externe** : Le signal de sortie est actif ou inactif en fonction du niveau du signal externe appliqué sur le connecteur **Ext Trig** de la face arrière. Lorsque le signal de commande est vrai, l'instrument envoie un signal continu. Si le signal de commande est faux, le cycle en cours se termine, puis l'instrument s'arrête et sa tension reste au niveau correspondant à la phase de rafale initiale du signal sélectionné. La sortie du signal de bruit s'arrête immédiatement lorsque le signal de commande devient faux.

Paramètre	Mode rafale (BURS:MOD-E)	Nombre de rafales (BURS:NCY-C)	Période de la rafale (BURS:INT:PE-R)	Phase de rafale (BURS:PHAS)	Source de déclenchement (TRIG:SOUR)
Mode rafale commandée : Déclenchement interne	TRIGgered	Disponible	Disponible	Disponible	IMMediate
Mode rafale commandée : Déclenchement externe	TRIGgered	Disponible	Non utilisé	Disponible	EXTernal, BUS
Mode rafale commandée : Déclenchement externe	GATed	Non utilisé	Non utilisé	Disponible	Non utilisé
Mode rafale temporisée : Déclenchement interne	TRIGgered	Disponible	Non utilisé	Disponible	TIMer

- En mode commandé, le nombre de rafales, la période de la rafale et la source de déclenchement sont ignorés (utilisés uniquement pour les rafales déclenchées). Déclenchements manuels ignorés ; aucune erreur générée.



## Consignes d'utilisation

- En mode commandé, vous pouvez spécifier la polarité du signal sur le connecteur **Ext Trig** de la face arrière ([SOURce[1|2]:]BURSt:GATE:POLarity {NORMal|INVerted}). La valeur par défaut est NORMAL (vrai/haut).

- Face avant :



- SCPI: [SOURce[1|2]:]BURSt:MODE {TRIGgered|GATed}

## Fréquence du signal

Vous pouvez spécifier la fréquence du signal pendant la rafale dans les modes rafale commandée externe et interne. En mode déclenché, le nombre de cycles spécifié par le nombre de salves est envoyé à la fréquence du signal. En mode externe commandé, la fréquence du signal est envoyée lorsque le signal de commande externe est vrai.

Cela est différent de la « période de la rafale » qui spécifie l'intervalle entre les salves (mode déclenché uniquement).

- Fréquence du signal : 1  $\mu$ Hz à la **fréquence maximale du signal**. La valeur par défaut est 1 kHz. (Pour un signal de rafale déclenchée en interne, la fréquence minimale est de 126  $\mu$ Hz sur la série 33500 ou de 251  $\mu$ Hz sur la série 33600.)

- Face avant :



- SCPI: [SOURce[1|2]:]FREQuency {<fréquence>|MINimum|MAXimum|DEFault}

La commande **APPLY** configure un signal à l'aide d'une commande unique.

## Nombre de rafales

Nombre de cycles (1 à 100 000 000 ou infini) à envoyer par rafale. Utilisé uniquement en mode rafale déclenchée (source interne ou externe).

- Avec la source interne de déclenchement immédiate, le nombre de cycles spécifié est envoyé en permanence à une vitesse déterminée par la période de la rafale. La période de la rafale est le temps entre les démarrages de rafales consécutives. Aussi, le nombre de rafales doit être inférieur au produit de la période de la rafale et de la fréquence du signal :

Période de la rafale > (Nombre de rafales)/(Fréquence du signal) + 1 µsec (série 33500)

Période de la rafale > (Nombre de rafales)/(Fréquence du signal) + 500 ns (série 33600)

- L'instrument augmente la période de la rafale jusqu'à sa valeur maximale pour prendre en charge le nombre de rafales spécifié (mais la fréquence du signal ne change pas).
- En mode rafale commandée, le nombre de rafales est ignoré. Cependant, si vous modifiez le nombre de rafales à partir de l'interface distante en mode commandé, l'instrument conserve le nouveau nombre qu'il utilise lorsque le mode déclenché est sélectionné.

- **Face avant :**



ou



- **SCPI:** `[SOURce[1|2]:]BURSt:NCYCles {<num_cycles>|INFinity|MINimum|MAXimum}`

## Période de la rafale

La période de la rafale est le temps écoulé entre le début d'une rafale et le début de la rafale suivante (1  $\mu$ s à 8 000 s, 10 ms par défaut pour la série 33500). Sur la série 33600, la plage est comprise entre 1  $\mu$ s et 4 000 s, et la valeur par défaut est également de 10 ms. La période de la rafale est différente de la « fréquence du signal » qui spécifie la fréquence du signal.

- La période de la rafale s'utilise uniquement lorsque le déclenchement immédiat est activé. La période de la rafale est ignorée lorsque le déclenchement externe ou interne (ou lorsque le mode rafale commandée est sélectionné).
- Il n'est pas possible de spécifier une période de rafale trop courte pour l'instrument à envoyer avec le nombre de rafales et la fréquence spécifiés. Si la période de rafale est trop faible, l'instrument l'augmente afin de déclencher à nouveau la rafale de façon continue.

- **Face avant :**

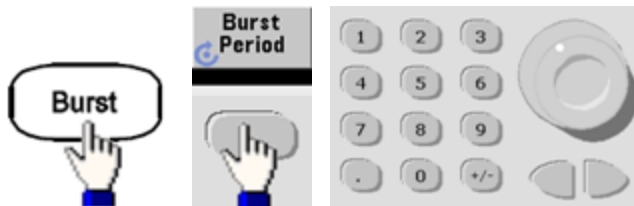

- **SCPI:** `[SOURce[1|2]:]BURSt:INTernal:PERiod {<secondes>|MINimum|MAXimum}`

## Phase initiale

Phase initiale de la rafale, comprise entre -360 et +360 degrés (par défaut 0).

- Spécifiez l'unité de la phase initiale à l'aide de la commande **UNIT:ANGLE**.
- Toujours affichée en degrés sur la face avant (jamais en radians). Si vous spécifiez des radians à partir de l'interface distante, l'instrument convertit la valeur en degrés sur la face avant.
- Pour les signaux sinusoïdaux, carrés et les rampes, 0 degré est le point auquel le signal traverse la tension de 0 V (ou la tension résiduelle CC) dans le sens positif. Pour les signaux arbitraires, 0 degré est le premier point du signal. La phase initiale n'a pas d'effet sur le bruit.
- Phase initiale également utilisée en mode rafale commandée. Lorsque le signal de commande devient faux, le cycle du signal actif se termine et la sortie demeure au niveau de tension de la phase de rafale initiale.

- **Face avant :**



- **SCPI:** `[SOURce[1|2]:]BURSt:PHASe {<angle>|MINimum|MAXimum}`

## Source de déclenchement de la rafale

En mode rafale déclenchée :

- L'instrument envoie un signal pendant un nombre spécifié de cycles (nombre de salves) lorsqu'un signal déclencheur est reçu. Après le nombre de cycles spécifié, l'instrument s'arrête et attend le déclenchement suivant.
- **IMMEDIATE (interne)** : l'instrument envoie la sortie en permanence lorsque le mode rafale est activé. La commande **BURSt:INTernal:PERiod** détermine la vitesse de génération de la rafale.
- **EXTernal** : l'instrument accepte un déclenchement matériel sur le connecteur **Ext Trig** de la face arrière. L'instrument envoie une rafale du nombre spécifié de cycles chaque fois que le connecteur **Ext Trig** reçoit une transition de niveau avec la polarité appropriée (**TRIGger[1|2]:SLOPe**). Les signaux de déclenchement externe pendant une rafale sont ignorés.
- **BUS (logiciel)** : l'instrument démarre une rafale chaque fois qu'une commande de déclenchement sur le bus (**\*TRG**) est reçue. La touche **[Trigger]** de la face avant s'allume lorsque l'instrument attend un déclenchement sur le bus.
- **EXTernal ou BUS** : le nombre de rafales et la phase de la rafale restent effectifs, mais la période est ignorée.
- **TIMER** : les événements de déclenchement sont espacés par une temporisation ; le premier déclenchement a lieu dès l'exécution de la commande **INIT**.
- **Face avant :**



- Pour indiquer si l'instrument se déclenche sur un front montant ou descendant du signal sur le connecteur Ext Trig, sélectionnez la source de déclenchement externe avant de choisir **Trigger Setup**.
- **SCPI:**

**TRIGger[1|2]:SOURce {IMMEDIATE|EXTernal|TIMER|BUS}**

**TRIGger[1|2]:SLOPe {POSitive|NEGative}**

Pour plus d'informations, reportez-vous à la section **Déclenchements**.

### REMARQUE

Si le rapport cyclique est modifié sur un signal carré déclenché en rafale avec le mode de déclenchement réglé sur Temporisé, la rafale en cours se termine et une nouvelle rafale est exécutée avant que le rapport cyclique de la rafale change.

## Signal Trigger Out

Un signal de sortie de déclenchement (trigger out) est fourni sur le connecteur **Ext Trig** de la face arrière (utilisé uniquement en mode rafale et balayage). Lorsqu'il est activé, une impulsion avec un front montant (par défaut) ou un front descendant est envoyée depuis ce connecteur au début du balayage ou de la rafale.

- Lorsque la source de déclenchement immédiate (interne) est sélectionnée, l'instrument envoie un signal carré doté d'un rapport cyclique de 50 % à partir du connecteur **Ext Trig** au début du balayage ou de la rafale. La fréquence du signal correspond à la période de la rafale ou au temps total de balayage spécifiés.
- Lorsque la source de déclenchement externe est sélectionnée, l'instrument désactive le signal « trigger out ». Le connecteur **Ext Trig** ne peut pas être utilisé simultanément pour les balayages ou les rafales et la sortie de déclenchement (un signal déclenché en externe utilise le même connecteur pour déclencher la rafale ou le balayage).
- Lorsque la source de déclenchement Manuel ou Bus (logiciel) est sélectionnée, l'instrument envoie une impulsion (largeur de  $> 1 \mu\text{s}$  sur la série 33500 et de 100 ns sur la série 33600) à partir du connecteur **Ext Trig** au début de chaque balayage ou rafale.

- **Face avant**



Choisissez ensuite le sens de front désiré à l'aide de la touche de fonction suivante :



- **SCPI:**

`OUTPut:TRIGger:SLOPe {POSitive|NEGative}`

`OUTPut:TRIGger {ON|1|OFF|0}`

## Déclenchements

Cette section décrit le système de déclenchement de l'instrument.

## Présentation des déclenchements

Les informations de déclenchement s'appliquent uniquement aux balayages et aux rafales. Vous pouvez envoyer des signaux de déclenchement de balayages ou de rafales par déclenchement interne, externe, temporisé ou manuel.

- Interne ou « automatique » (par défaut) : l'instrument émet en permanence lorsque le mode balayage ou rafale est sélectionné.
- Externe : le connecteur **Ext Trig** de la face arrière commande le balayage ou la rafale. L'instrument démarre un balayage ou envoie une rafale chaque fois que **Ext Trig** reçoit une impulsion. Vous pouvez déterminer si l'instrument se déclenche sur un front montant ou descendant.
- Manuel : le déclenchement démarre un balayage ou envoie une rafale chaque fois que vous appuyez sur la touche [**Trigger**] de la face avant.
- Lorsque vous effectuez un balayage en mode liste, le déclenchement déplace le signal vers la fréquence suivante de la liste.
- La touche [**Trigger**] est désactivée en mode distant et lorsqu'une fonction autre que le balayage ou la rafale est actuellement sélectionnée.

## Sources de déclenchement

Les informations de déclenchement s'appliquent uniquement aux balayages et aux rafales. Vous devez spécifier la source à partir de laquelle l'instrument accepte un déclenchement.

- Source de déclenchement du balayage et de la rafale : Immédiate (par défaut), externe, manuelle ou temporisée.
- L'instrument accepte un déclenchement manuel, un déclenchement matériel sur le connecteur **Ext Trig** de la face arrière ou envoie en permanence des balayages ou des rafales au moyen d'un déclencheur interne. Vous pouvez également déclencher des rafales temporisées. Le déclenchement immédiat est sélectionné à la mise sous tension.
- Le paramètre de la source de déclenchement est volatile ; il est configuré comme déclenchement interne (face avant) ou immédiat (interface distante) lors d'une remise sous tension ou de l'exécution de la commande **\*RST**.
- **Face avant :**  
Activez le mode balayage ou rafale. Ensuite :



- **SCPI:** `TRIGger[1|2]:SOURce {IMMediate|EXTernal|TIMer|BUS}`
- La commande **APPLY** définit automatiquement la source sur Immediate.

### Déclenchement immédiat

Mode de déclenchement interne (par défaut) : l'instrument envoie en permanence un balayage ou une rafale (spécifié par le temps du balayage ou la période de la rafale).

Face avant :

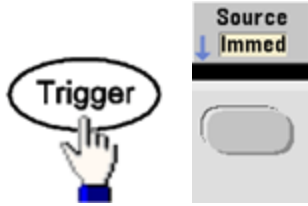

SCPI: **TRIGger:SOURce IMMEDIATE**

### Déclenchement manuel

Mode de déclenchement manuel (face avant uniquement) : appuyez sur la touche **[Trigger]** pour déclencher manuellement l'instrument. L'instrument déclenche un balayage ou une rafale chaque fois que vous appuyez sur la touche **[Trigger]**. Le bouton est allumé lorsque vous êtes dans le menu de déclenchement et l'instrument attend un déclenchement manuel. Il clignote lorsque l'instrument attend un déclenchement manuel, mais que vous n'êtes pas dans le menu de déclenchement. La touche est désactivée lorsque l'instrument est en mode de commande à distance.

### Déclenchement externe

En mode de déclenchement externe, l'instrument accepte un déclenchement matériel sur le connecteur **Ext Trig** de la face arrière. L'instrument démarre un balayage ou envoie une rafale chaque fois que Ext Trig reçoit une impulsion TTL avec le front spécifié. Le mode de déclenchement externe est similaire au mode de déclenchement manuel, à la différence près que vous appliquez le déclencheur sur le connecteur **Ext Trig** de la face arrière.

Voir **Signal d'entrée de déclenchement** ci-dessous.

Face avant :



Pour indiquer si l'instrument se déclenche sur un front montant ou descendant, appuyez sur **Trigger Setup** et sélectionnez le sens du front en appuyant sur **Slope**.

SCPI:

**TRIGger:SOURce EXTERNAL**

**TRIGger[1|2]:SLOPe {POSitive|NEGative}**

## Déclenchement par logiciel (Bus)

Disponible uniquement à partir de l'interface distante, ce déclenchement est similaire au mode de déclenchement manuel à partir de la face avant, excepté que vous déclenchez l'instrument avec une commande de déclenchement sur le bus. L'instrument démarre un balayage ou envoie une rafale chaque fois qu'une commande de déclenchement sur le bus est reçue. La touche clignote lorsqu'une commande de déclenchement sur le bus est reçue.

Pour sélectionner la source de déclenchement sur le bus, exécutez la commande **TRIGger:SOURce BUS**.

Pour déclencher l'instrument à partir d'une interface distante (GPIB, USB ou réseau local (LAN)) lorsque la source Bus est sélectionnée, exécutez la commande **TRIG** ou **\*TRG** (déclenchement). La touche **[Trigger]** de la face avant s'allume lorsque l'instrument attend un déclenchement sur le bus.

## Déclenchement temporisé

Le mode de déclenchement temporisé envoie un signal de déclenchement à intervalles de temps constants. Pour sélectionner la source de déclenchement sur le bus, exécutez la commande **TRIGger:SOURce TImer**.

## Signal d'entrée de déclenchement

Ce connecteur de la face arrière est utilisé dans les modes suivants :

- Mode de balayage déclenché : Appuyez sur **Trigger Setup > Source Ext** ou exécutez la commande **TRIG:SOUR EXT** (le mode balayage doit être activé). Lorsqu'une transition de niveau de la polarité adéquate est reçue sur le connecteur **Ext Trig**, l'instrument envoie un balayage.
- Mode de modulation externe par déplacement de fréquence (FSK) : Appuyez sur **Source** ou exécutez la commande **FSK:SOUR EXT** (la modulation FSK doit être activée). Lorsque le niveau est bas, la fréquence du signal porteur est envoyée. Lorsque le niveau est haut, la fréquence de saut est envoyée. La vitesse FSK externe maximale est de 100 kHz.
- Mode rafale commandée : Appuyez sur **Trigger Setup > Source Ext** ou exécutez la commande **TRIG:SOUR EXT** (le mode rafale doit être activé). L'instrument envoie un signal pendant un nombre spécifié de cycles (nombre de salves) chaque fois que le signal déclencheur est reçu de la source de déclenchement spécifiée.
- Mode rafale commandée externe : Appuyez sur la touche de fonction **Gated** ou exécutez la commande **BURS:MODE GAT** avec le mode rafale activé. Lorsque le signal de commande externe est vrai, l'instrument envoie un signal continu. Si le signal de commande externe est faux, le cycle en cours se termine, puis l'instrument s'arrête et sa tension reste au niveau correspondant à la phase de rafale initiale. Pour le bruit, la sortie s'arrête dès que le signal de commande devient faux.



## Signal de sortie de déclenchement

**ATTENTION** Le signal de sortie de déclenchement est relié au châssis et se situe physiquement en regard de l'entrée de modulation externe, qui est flottante. Veillez à ne pas toucher les deux signaux simultanément lors du branchement ou du débranchement de ces câbles. Désactivez les connexions à la sortie de l'instrument avant de brancher ou de débrancher ces câbles.

- Un signal de sortie de déclenchement (trigger out) est fourni sur le connecteur **Ext Trig** de la face arrière (utilisé uniquement en mode rafale et balayage). Lorsqu'il est activé, une impulsion avec un front montant (par défaut) ou un front descendant est envoyée depuis ce connecteur au début du balayage ou de la rafale.

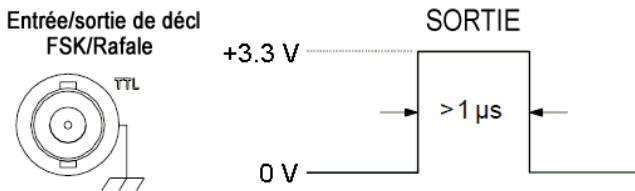

*Front montant illustré*

**REMARQUE** Le schéma ci-dessus présente le déclenchement sur la série 33500. Sur la série 33600, la largeur d'impulsion est de 100 ns et le niveau de tension peut être programmé (pas obligatoirement la tension de +3,3 V indiquée). Pour plus d'informations sur la définition de cette valeur, voir **TRIGger:LEVel**.

- **Interne (immédiat) ou source de déclenchement temporisée** : l'instrument envoie un signal carré de rapport de cycle égal à 50 % provenant du connecteur **Ext Trig** au début du balayage ou de la rafale. La période du signal est égale au temps de balayage spécifié ou à la période de la rafale.
- **Source de déclenchement externe** : l'instrument désactive le signal « sortie de déclenchement ». Le connecteur **Ext Trig** de la face arrière ne peut pas être utilisé simultanément pour les deux opérations (le balayage à déclenchement externe utilise le même connecteur pour déclencher le balayage ou la rafale).
- **Source de déclenchement manuel ou sur le bus (logiciel)** : l'instrument envoie une impulsion (largeur  $> 1 \mu s$ ) à partir du connecteur **Ext Trig** au début du balayage ou de la rafale.
- **Face avant** : Activez le mode de balayage ou rafale. Ensuite :



Choisissez ensuite le sens de front désiré à l'aide de la touche de fonction suivante :



- **SCPI:**  
**OUTPut:TRIGger:SLOPe {POSitive|NEGative}**  
  
**OUTPut:TRIGger {ON|1|OFF|0}**

## Opérations sur 2 voies

Cette section couvre la plupart des sujets en rapport avec le fonctionnement sur 2 voies. Elle ne traite pas de l'option **IQ Player**.

### Passage en configuration 2 voies

Appuyez sur le bouton de sortie des voies, sur **More**, puis sur **Dual Channel** pour passer en configuration 2 voies.

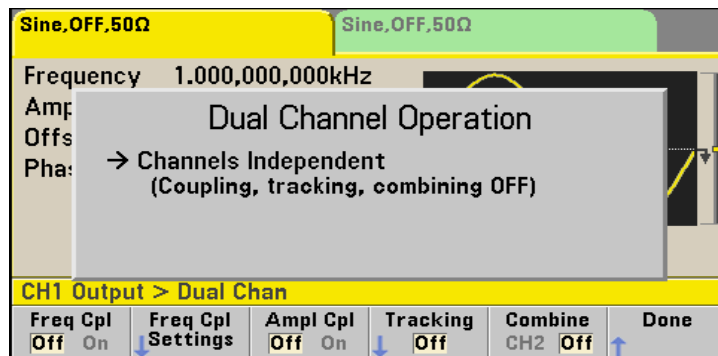

### Couplage des fréquences

La fonction de couplage des fréquences permet de coupler des fréquences ou des fréquences d'échantillonnage entre des voies, par un rapport ou un écart constant entre elles. Appuyez sur **Freq Cpl** pour activer/désactiver le couplage des fréquences, puis sur **Freq Cpl Settings** pour configurer le couplage.

La touche de fonction **Freq Cpl Settings** permet d'accéder au menu ci-dessous. La première touche de fonction permet de déterminer si les fréquences doivent être couplées avec un rapport ou un écart ; la deuxième permet de spécifier ce rapport ou cet écart.

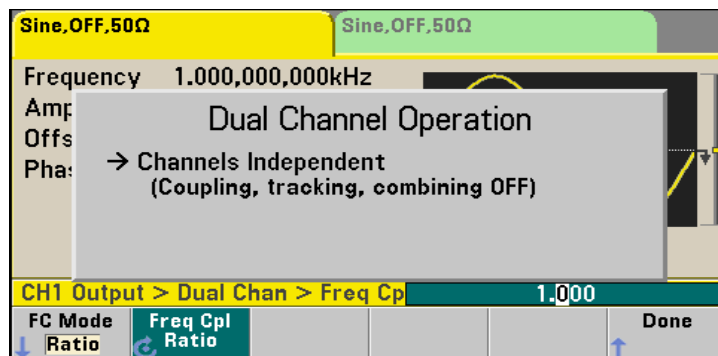

## Couplage des amplitudes

Activée à l'aide de la touche de fonction **Ampl Cpl**, la fonction de couplage des amplitudes permet de coupler l'amplitude et la tension résiduelle entre les voies de façon qu'une modification d'une de ces grandeurs se répercute sur les 2 voies.

## Suivi

Activée à l'aide de la touche de fonction **Tracking**, la fonction de suivi comporte 3 modes : **Off**, **On** et **Invert**. Lorsque le suivi est désactivé, les 2 voies fonctionnent indépendamment l'une de l'autre. Lorsqu'elle est activée, les 2 voies se comportent comme une seule voie. Le troisième mode **Invert**, inverse chaque voie par rapport à l'autre : le résultat est une voie différentielle utilisant les 2 voies.

## Combine

La fonction **Combine** associe 2 sorties sur un connecteur. Si vous choisissez **CH2** dans le menu **Channel 1**, les voies sont associées sur la voie 1 ; si vous choisissez **CH1** dans le menu **Channel 2**, elles sont associées sur la voie 2.

Dans l'illustration ci-dessous, le signal supérieur est un signal sinusoïdal 100 mVpp / 1 kHz sur la voie 1 ; le signal inférieur est un signal sinusoïdal 100 mVpp / 5 kHz sur la voie 2.

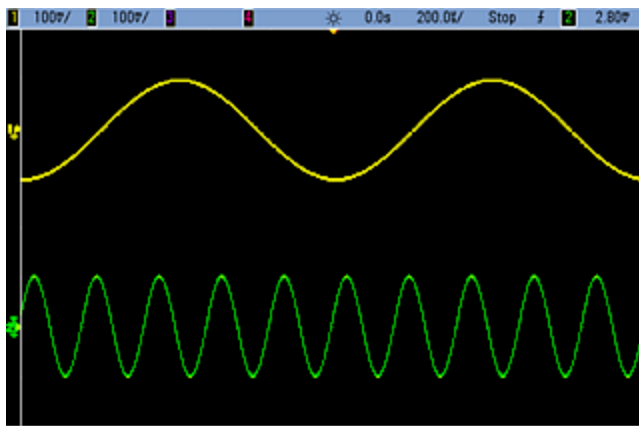

L'illustration ci-dessous représente les 2 sorties groupées sur la voie 1. Notez que l'axe X a été comprimé (réduit) pour afficher un plus grand nombre de cycles.

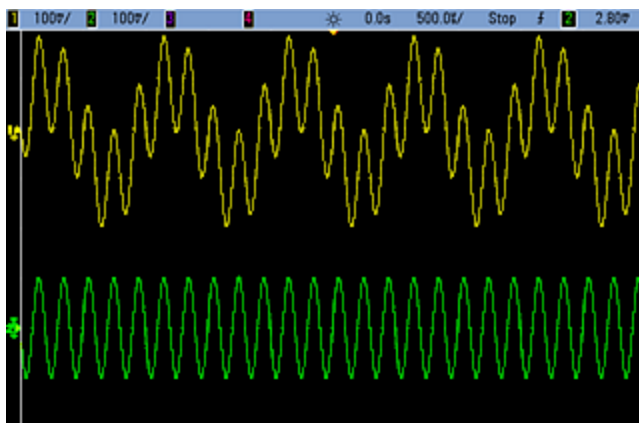

Les signaux groupés ne doivent pas être du même type ; par exemple, cette illustration représente la même voie 5 kHz sur la voie 2 groupée avec un signal carré 100 mVpp sur la voie 1.

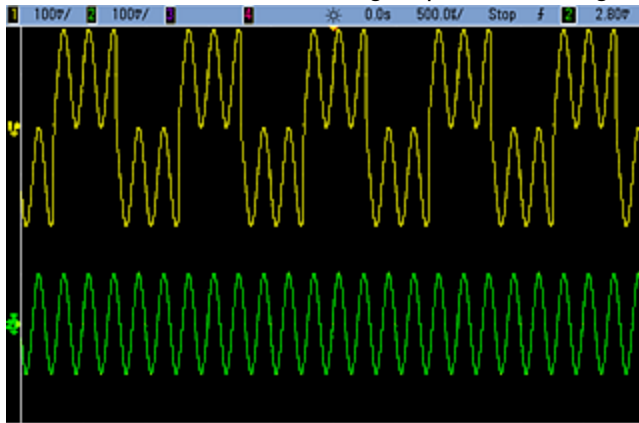

Lorsque les signaux sont groupés, les valeurs de tension résiduelle CC ne sont pas ajoutées. Seule la tension résiduelle CC de la voie réceptrice est utilisée dans la sortie groupée. La figure ci-dessous représente une tension résiduelle CC de 50 mV ajoutée sur la voie 1. La tension résiduelle de 50 mV ajoutée à la voie 2 est ignorée.

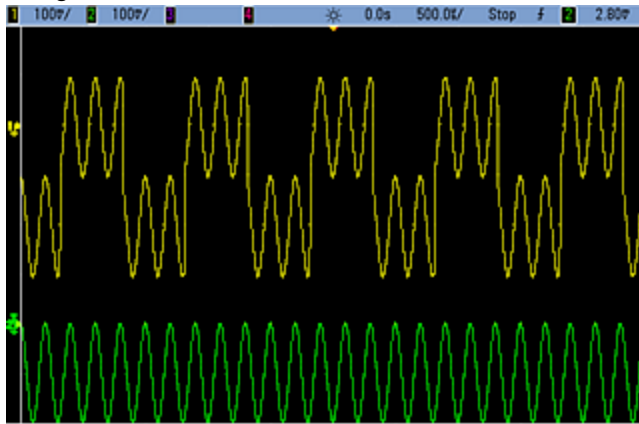

Vous pouvez également utiliser la fonction **Combine** avec des rafales. Par exemple, l'illustration ci-dessous représente un signal sinusoïdal de 1 kHz sur la voie 1 et une rafale de 3 cycles d'un signal sinusoïdal de 5 kHz sur la voie 2.

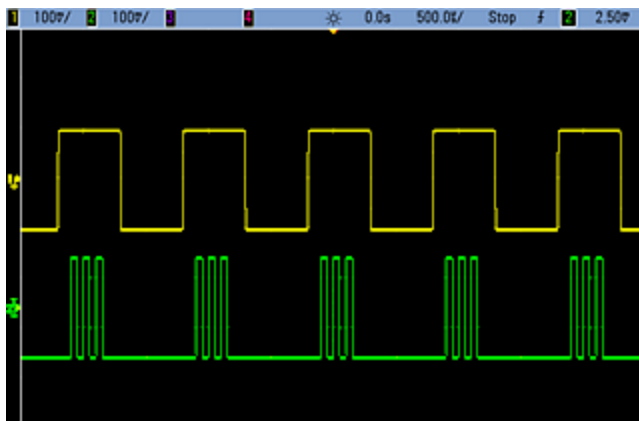

## Consignes d'utilisation

Lorsque ces signaux sont groupés sur la voie 1, le résultat est un simple ajout de l'amplitude des deux signaux, comme indiqué ci-dessous.

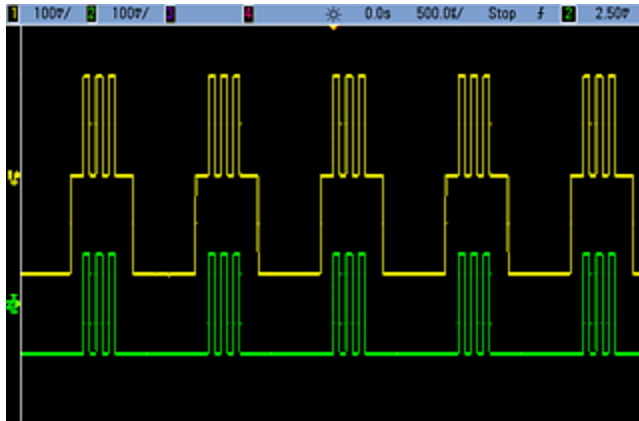

Vous pouvez également grouper les signaux sur la voie 2, comme indiqué ci-dessous.

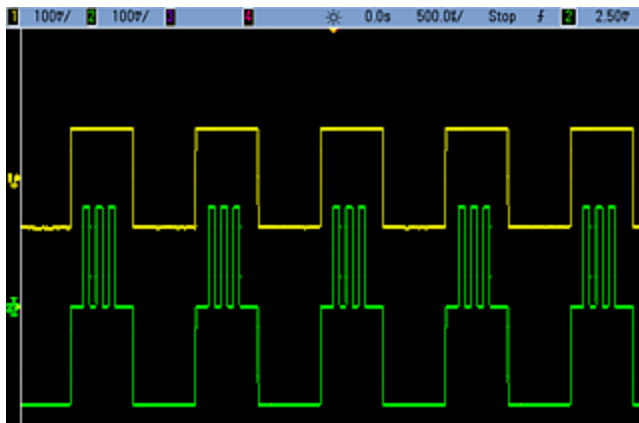

## IQ Player (option)

L'option **IQ Player** permet de lire des signaux arbitraires doubles, tels que des signaux IQ en bande de base.

Un double signal arbitraire est analogue à un fichier audio stéréo. Il comporte deux canaux d'informations qui contiennent le même nombre d'échantillons, commencent et se terminent toujours ensemble et sont toujours lus à la même fréquence d'échantillonnage.

### Formats de fichier

Les fichiers aux formats natifs **.ARB** et **.BARB** peuvent contenir une ou deux voies de données. Ces fichiers, généralement créés dans le logiciel **Keysight BenchLink Waveform Builder**, peuvent être lus directement sur l'instrument.

Vous pouvez également lire des fichiers ayant l'extension **.DAT**, **.ASC**, **.I** et **.Q**. Ces formats de fichiers contiennent une ou deux colonnes de nombres en ASCII compris entre -1.0 et 1.0, en notation scientifique ou décimale. Les données représentent la « forme » relative du signal dans la plage d'amplitude active.

Enfin, vous pouvez importer des fichiers de 1 ou 2 colonnes au format .CSV ou .TXT. Pour importer un fichier, appuyez sur **[Waveforms]** > **Arb** > **Arbs** > **Import Data**. Une interface de menu s'ouvre pour vous guider à travers les étapes d'importation d'un fichier.

### Face avant

Lorsque le signal actif est un signal arbitraire double, l'onglet s'affiche en violet, comme indiqué ci-dessous.

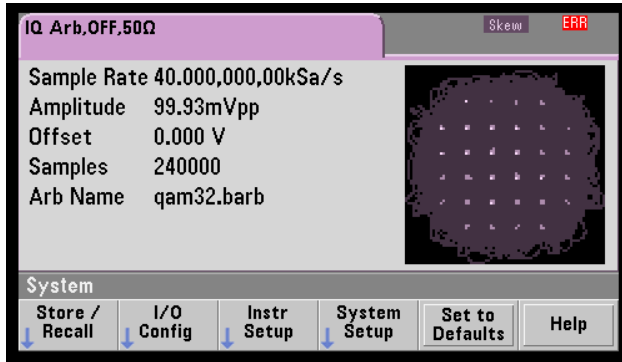

L'image du signal est un nuage de points. Cependant, vous pouvez le modifier dans le domaine temporel. Pour cela, appuyez sur **[System]** > **System Setup** > **Screen Layout**. Vous êtes alors renvoyé vers le menu suivant :



Appuyez sur la touche de fonction **Time** pour représenter le graphique dans le domaine temporel :

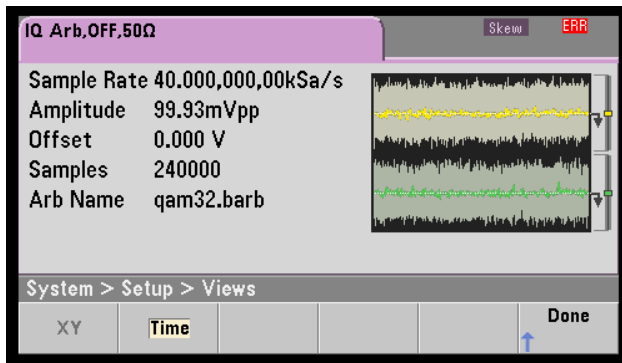

## Consignes d'utilisation

### Balance Adjust

Si vous appuyez sur **More** dans le menu [**Parameters**], vous accédez à la page 2 du menu [**Parameters**] :

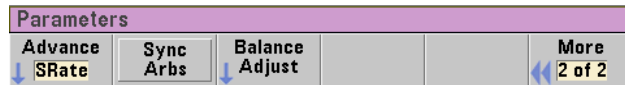

Dans ce menu, vous pouvez appuyer sur **Balance Adjust** pour accéder à un menu qui permet de spécifier le gain d'amplitude et les tensions résiduelles des voies :

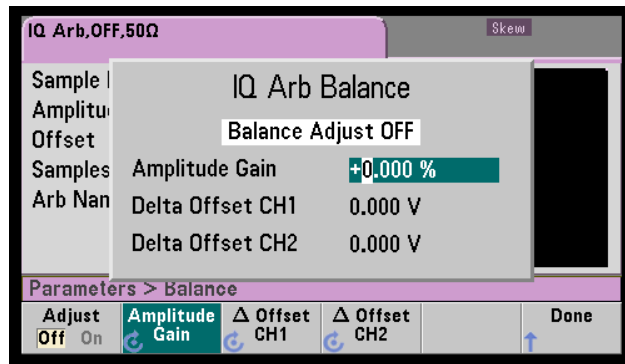

### IQ Arb Skew

Pour compenser un petit déphasage entre les voies, appuyez sur les boutons de sortie des voies, puis sur **More** pour accéder à la page 2 du menu :

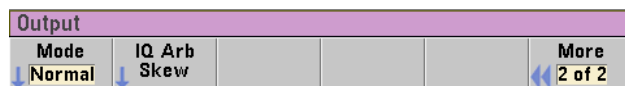

Dans ce menu, appuyez sur **IQ Arb Skew** pour accéder au menu suivant qui permet de compenser des déphasages jusqu'à 4 ns sur la série 33500 ou jusqu'à 1 ns sur la série 33600 :

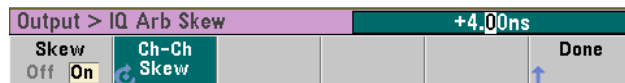

## Commandes SCPI

Huit commandes SCPI sont associées à IQ Player :

### Chargement de signaux arbitraires doubles

```
[SOURce[1|2]:]DATA:ARbitrary[1|2] <nom_signal_arb>, {<bloc_binaire>|<valeur>, <valeur>, ...}
```

```
[SOURce[1|2]:]DATA:ARbitrary[1|2]:DAC <nom_signal_arb>, {<bloc_binaire>|<valeur>, <valeur>, ...}
```

```
[SOURce[1|2]:]DATA:ARbitrary2:FORMat {AABB|ABAB}
```

### Réglage de la lecture de signaux arbitraires doubles

```
FUNcTion:ARbitrary:BALance:GAIN {<pourcentage>|MINimum|MAXimum|DEFine}
```

```
FUNcTion:ARbitrary:BALance:OFFSet{1|2} {<volts>|MINimum|MAXimum|DEFault}
```

```
FUNcTion:ARbitrary:BALance[:STATe] {ON|1|OFF|0}
```

```
FUNcTion:ARbitrary:SKEW[:STATe] {ON|1|OFF|0}
```

```
FUNcTion:ARbitrary:SKEW:TIME [{<temps>|MINimum|MAXimum|DEFault}]
```

## Opérations système

Cette section décrit l'enregistrement des états de l'instrument, le rappel après extinction, les conditions d'erreur, les autotests et le contrôle de l'affichage. Bien qu'elles n'aient pas de lien avec la génération de signaux, ces opérations sont essentielles au bon fonctionnement de l'instrument.

### Enregistrement des états de l'instrument

- Il existe deux manières d'enregistrer et d'extraire des états de l'instrument :
  - à l'aide des noms de fichiers d'état sur la face avant, via les commandes **MMEMory:STORe:STATe** et **MMEMory:LOAD:STATe**
  - au moyen des emplacements en mémoire 1 et 4, via les commandes **\*SAV** et **\*RCL**

**REMARQUE** Pour les instruments série 33600, les fichiers de configuration associés à \*SAV et \*RCL sont enregistrés dans des fichiers appelés STATE\_0.STA à STATE\_4.STA. Ces derniers sont situés dans le répertoire Paramètres de la mémoire interne. Vous pouvez gérer ces fichiers à l'aide des commandes **MMEMory**.

- Vous pouvez également utiliser l'emplacement d'enregistrement spécial 0 avec les commandes \*SAV et \*RCL. Toutefois, cet emplacement est remplacé par l'état actuel de l'instrument à l'extinction.
- Les deux méthodes d'enregistrement conservent la fonction sélectionnée (y compris les signaux arbitraires), la fréquence l'amplitude, la tension résiduelle CC, le rapport cyclique, la symétrie et les paramètres de modulation.
- Si vous supprimez un signal arbitraire en mémoire non volatile après avoir enregistré l'état de l'instrument, les données du signal sont perdues et l'instrument utilise la « croissance exponentielle » à la place.



## Consignes d'utilisation

- La commande \*RST n'affecte pas les états enregistrés ; un état persiste tant qu'il n'a pas été remplacé ou supprimé.
- Face avant :

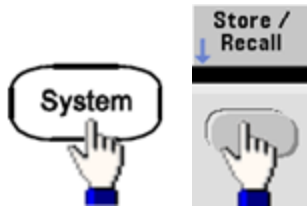

Pour enregistrer un état :



Le fichier d'état est créé avec l'extension .sta en utilisant le nom que vous avez spécifié à l'aide du bouton et des flèches.

Pour rappeler un état :



Développez un dossier à l'aide de la touche fléchée droite. Pour sélectionner un fichier, appuyez sur **Select**.

Pour supprimer un état :



Sélectionnez un fichier .sta à l'aide du bouton et des flèches, puis appuyez sur **Select**.

- À la mise sous tension, vous pouvez configurer l'instrument à l'état d'extinction depuis l'emplacement 0. Par défaut, l'état par défaut à la sortie d'usine est adopté à la mise sous tension.
- Face avant :



- SCPI: **MEMory:STATe:RECall:AUTO {ON|1|OFF|0}**

### Conditions d'erreur

Il est possible d'enregistrer jusqu'à 20 erreurs de syntaxe de commande ou matérielles dans chaque liste des erreurs des interfaces (une pour chaque erreur GPIB, USB, VXI-11 et Telnet/Sockets). Pour de plus amples informations, reportez-vous à la section **Messages d'erreur SCPI**.

- Face avant :



- SCPI: **SYSTem:ERRor?**

### Contrôle de l'avertisseur sonore

En cas d'erreur, l'instrument émet généralement un signal sonore sur la face avant ou l'interface distante.

- Ce paramètre est non volatile ; il n'est pas modifié par une remise sous tension ou l'exécution de la commande **\*RST**.
- Face avant :

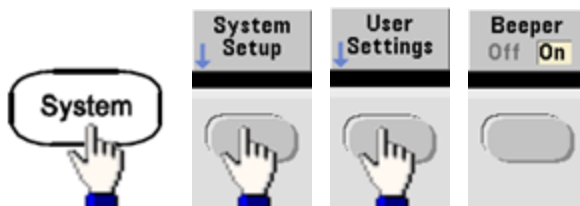

- SCPI:  
**SYSTem:BEEPer:STATe {ON|1|OFF|0}**

**SYSTem:BEEPer**

**REMARQUE** Sur la série 33600, vous pouvez également activer et désactiver le son des clics lorsqu'une touche est enfoncée. Pour plus d'informations, voir **SYSTem:CLICk:STATe**.

## Affichage de l'écran de veille

Le rétroéclairage de l'écran s'éteint généralement et réduit la luminosité de l'écran après 8 heures d'inactivité. Vous pouvez désactiver cet écran de veille uniquement sur la face avant.

- Ce paramètre est non volatile ; il n'est pas modifié par une remise sous tension ou l'exécution de la commande **\*RST**.
- Face avant :

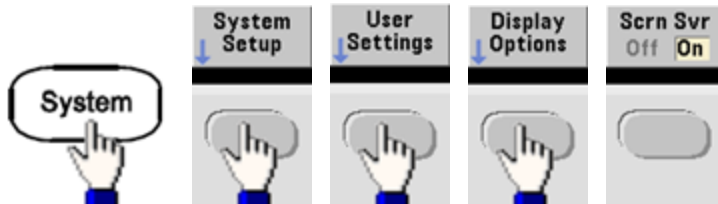

## Luminosité de l'écran

Vous pouvez régler la luminosité de l'écran (entre 10 et 100 %) uniquement sur la face avant.

- Ce paramètre est non volatile ; il n'est pas modifié par une remise sous tension ou l'exécution de la commande **\*RST**.
- Face avant :

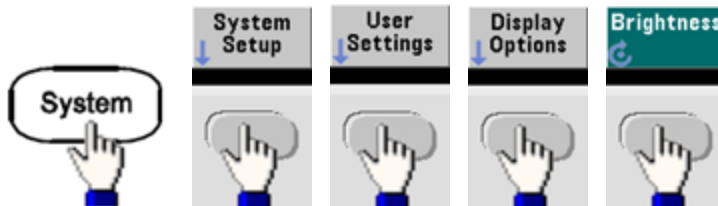

## Date et heure

Vous pouvez régler la date et l'heure de l'instrument.

- Face avant :



- SCPI :  
**SYSTem:DATE <aaa>, <mm>, <jj>**  
**SYSTem:TIME <hh>, <mm>, <ss>**

## Gestion des fichiers

Vous pouvez effectuer des opérations de gestion des fichiers (copier, renommer, supprimer et créer des dossiers).

- **Face avant :**

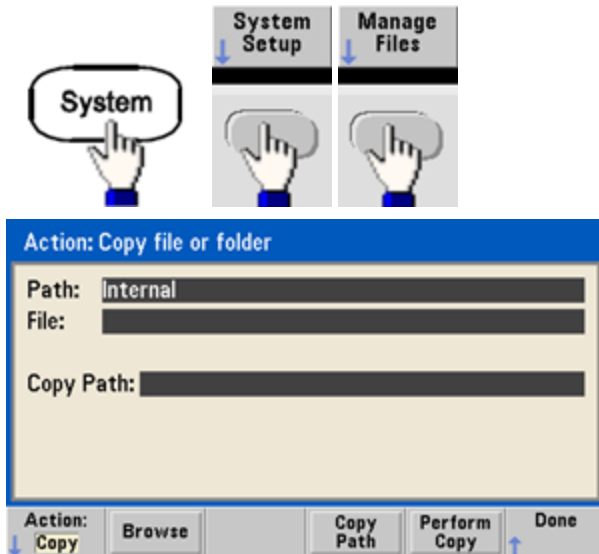

- Vous pouvez copier, renommer ou supprimer des fichiers et des dossiers. La suppression d'un dossier entraîne également celle de tous les fichiers qu'il contient. Vérifiez donc que vous voulez supprimer tous les fichiers d'un dossier.
- La touche de fonction la plus importante est **Action**, qui permet de spécifier l'opération à effectuer. Après avoir choisi l'action à effectuer, appuyez sur **Browse** pour sélectionner le fichier. Lorsque vous êtes prêt à exécuter l'opération, appuyez sur **Perform**.
- **SCPI:** (voir les sous-systèmes **MEMory** et **MMEMory**).

## Autotest

- Un autotest limité a lieu à la mise sous tension de l'instrument afin de vérifier qu'il est opérationnel. Vous pouvez également effectuer un autotest plus complet. Pour plus d'informations, reportez-vous à la section **Procédures d'autotest**.

## Contrôle de l'affichage

Pour des raisons de sécurité ou pour accélérer l'exécution des commandes de l'interface distante par l'instrument, vous souhaitez peut-être **désactiver l'écran**. Vous pouvez également **afficher un message** à distance ou **effacer un message** sur l'écran.

- L'écran est activé à la remise sous tension, après une réinitialisation de l'instrument (**\*RST**) ou lorsque vous revenez en mode local (face avant). Appuyez sur la touche **[Local]** ou exécutez la commande IEEE-488 GTL (Go To Local) à partir de l'interface distante pour revenir en mode local.
- L'état de l'écran est enregistré lorsque vous sauvegardez l'état de l'instrument à l'aide de la commande **\*SAV** et le rappelez à l'aide de la commande **\*RCL**.
- **Face avant :**

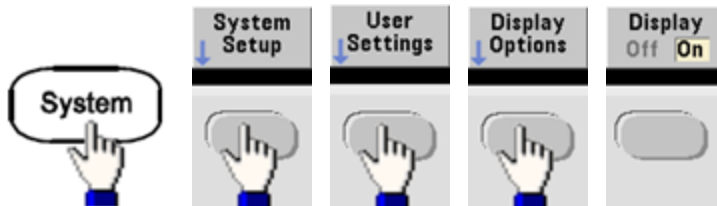

- **SCPI:**

**DISPlay {ON|1|OFF|0}**

**DISPlay:TEXT "< chaîne de caractères >"**

**DISPlay:TEXT:CLEAr**

## Format numérique

L'instrument affiche sur la face avant des nombres contenant des points ou des virgules comme virgule décimale et séparateur. Par défaut, la notation décimale est le point et le séparateur la virgule (1 000 000,00 kHz => 1,000,000.00 kHz).

- Ce paramètre est non volatile ; il n'est pas modifié par une remise sous tension ou l'exécution de la commande **\*RST**.
- **Face avant :**

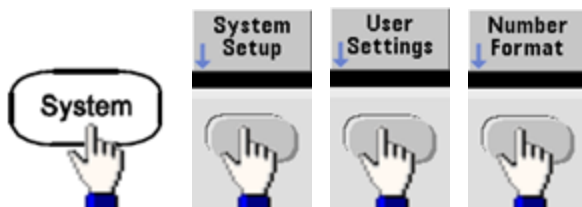

- **SCPI :** (Aucune commande équivalente)

## Demande de la version du microprogramme

Exécutez la commande **\*IDN?** pour déterminer la version du microprogramme actuellement installée. Cette demande renvoie une chaîne de caractères sous la forme suivante :

**Keysight Technologies,[Numéro du modèle],[Numéro de série sur 10 caractères],A.aa-B.bb-C.cc-DD-EE**



- Face avant :
- SCPI: **\*IDN?**

## Version du langage SCPI

L'instrument est conforme aux règles et aux conventions de la version actuelle du langage SCPI (Standard Commands for Programmable Instruments). Utilisez la commande **SYSTem:VERSion?** pour déterminer la version SCPI de l'instrument. Cette requête renvoie une chaîne de caractères sous la forme « YYYY.V » qui représente l'année et le numéro de la version de cette année (par ex., 1999.0).

## Installation de la licence

La série Trueform comporte **plusieurs fonctionnalités logicielles** nécessitant l'installation de licences. Pour installer une licence :

1. Installez le fichier de licence sur une clé USB et introduisez cette clé dans la face avant de l'instrument.
2. Appuyez sur **[System] > System Setup > Install License**.
3. Sélectionnez le fichier sous **External** à l'aide du bouton et des flèches, puis appuyez sur **Enter**.

Plusieurs **commandes SCPI sont également associées à l'installation de licences**.

## Configuration de l'interface distante

L'instrument prend en charge les communications avec l'interface distante sur 3 interfaces : GPIB (option), USB et LAN. Ces trois interfaces sont actives à la mise sous tension.

- **Interface GPIB** : Configurez l'adresse GPIB de l'instrument afin de connecter l'instrument à votre PC avec un câble GPIB.
- **Interface USB** : Aucune configuration ; connectez simplement l'instrument au PC avec un câble USB.
- **Interface LAN** : Par défaut, le protocole DHCP est activé pour permettre les communications sur un réseau local. DHCP est l'abréviation de Dynamic Host Configuration Protocol ; il s'agit d'un protocole d'affectation d'adresses IP dynamiques IP aux périphériques sur un réseau. Avec l'adressage dynamique, un périphérique peut avoir une adresse IP différente chaque fois qu'il se connecte au réseau.

## CD du produit et du logiciel de connexion

L'instrument est livré avec 2 CD-ROM :

- **CD-ROM Keysight IO Libraries Suite** : Contient le logiciel Keysight IO Libraries Suite, qui doit être installé pour les opérations sur l'interface distante. Le CD démarre automatiquement et fournit des informations sur l'installation du logiciel. Inclut également le manuel *Keysight Technologies USB/LAN/GPIB Connectivity Guide* qui fournit des informations supplémentaires.
- **CD Keysight Trueform Series Product Reference** : Contient les pilotes de l'instrument, la documentation du produit et des exemples de programmation. Démarre automatiquement et fournit des instructions.

## Configuration de la connexion GPIB

Chaque périphérique sur l'interface GPIB (IEEE-488) doit posséder une adresse unique comprise entre 0 et 30. L'instrument est livré avec l'adresse par défaut 10, affichée à la mise sous tension.

- Ce paramètre est non volatile ; il n'est pas modifié par une remise sous tension ou l'exécution de la commande **\*RST**.
- L'interface GPIB de votre ordinateur ne doit pas être en conflit avec un instrument sur le bus de l'interface.
- **Face avant** :  
Appuyez sur **[System] > I/O Config > GPIB Settings** pour définir l'adresse GPIB, et activer ou désactiver GPIB.

- **SCPI:**  
`SYSTem:COMMunicate:GPIB:ADDRess <adresse>`

`SYSTem:COMMunicate:ENABLE <state>,GPIB`

`SYSTem:COMMunicate:ENABLE? GPIB`

## Configuration du réseau local (LAN)

Les sections suivantes décrivent les fonctions de base de configuration du réseau local situées sur la face avant, et notamment les commandes SCPI le cas échéant. Certaines fonctions de configuration du réseau local peuvent être exécutées uniquement via des commandes SCPI. Reportez-vous à la section **Introduction à la configuration du réseau local** pour obtenir une liste des commandes de configuration du réseau local et à la section **Procédure de configuration du réseau local** pour connaître la procédure de configuration du réseau local sur la face avant.

### REMARQUE

Certains paramètres du réseau local requièrent une remise sous tension de l'instrument pour être activés. Dans ce cas, l'instrument affiche brièvement un message. Examinez donc attentivement l'écran lorsque vous modifiez les paramètres du réseau.

### Réinitialisation du réseau local

Vous pouvez effacer le mot de passe de l'interface Web, activer le protocole DHCP et redémarrer le réseau local à tout moment :

- **Face avant :**



Le message « Performing LAN Reset » (Réinitialisation en cours du réseau local) s'affiche lorsque le réseau local est réinitialisé.

- **SCPI :** (Aucune commande équivalente)

### Activation/désactivation du protocole DHCP

Le protocole DHCP (Dynamic Host Configuration Protocol) affecte automatiquement une adresse IP dynamique à un périphérique LAN. C'est généralement la manière la plus facile de configurer l'instrument pour le réseau local.

- Ce paramètre est non volatile ; il n'est pas modifié par une remise sous tension ou l'exécution de la commande **\*RST**.

- **Face avant :**

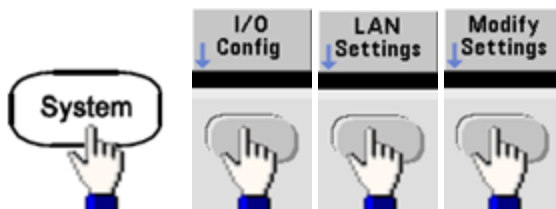

Enfin, configurez la première touche de fonction sur DHCP pour utiliser le protocole DHCP et affecter automatiquement une adresse IP.

- **SCPI:** **SYSTem:COMMunicate:LAN:DHCP {ON|1|OFF|0}**

Pour configurer manuellement une adresse IP, un masque de sous-réseau ou une passerelle par défaut, désactivez le protocole DHCP, puis modifiez l'adresse IP conformément aux instructions ci-après.



## Adresse IP

Vous pouvez saisir une adresse IP statique pour l'instrument sous la forme d'entier à 4 octets séparés par des points. Chaque octet est une valeur décimale sans zéro initial (par ex., 169.254.2.20).

- Si le protocole DHCP est activé, il tente d'affecter une adresse IP à l'instrument. En cas d'échec, AutoIP tente d'affecter une adresse IP à l'instrument.
- Contactez votre administrateur réseau pour obtenir une adresse IP.
- Ce paramètre est non volatile ; il n'est pas modifié par une remise sous tension ou l'exécution de la commande **\*RST**.

- **Face avant :**

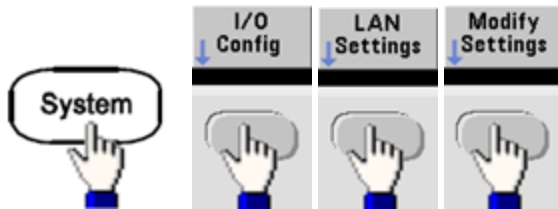

- Enfin, configurez la première touche de fonction sur **Manual** et appuyez sur **IP Address** pour saisir une nouvelle adresse IP. Saisissez l'adresse désirée.
- **SCPI:** `SYSTem:COMMunicate:LAN:IPADdress "<adresse>"`

## Masque de sous-réseau

Le masque de sous-réseau permet à l'administrateur réseau de sous-diviser un réseau pour simplifier sa gestion et minimiser le trafic sur le réseau. Le masque de sous-réseau indique la partie de l'adresse de l'hôte utilisée pour désigner le sous-réseau.

- Pour plus d'informations, contactez votre administrateur réseau.
- Ce paramètre est non volatile ; il n'est pas modifié par une remise sous tension ou l'exécution de la commande **\*RST**.

- **Face avant :**

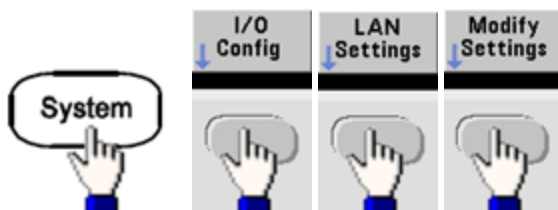

- Enfin, configurez la première touche de fonction sur **Manual** et appuyez sur **Subnet Mask** pour entrer un nouveau masque de sous-réseau à l'aide du clavier numérique ou du bouton (par ex., 255.255.0.0).
- **SCPI:** `SYSTem:COMMunicate:LAN:SMASk "<masque>"`

### Passerelle par défaut

Une passerelle est un périphérique de connexion au réseau. La passerelle par défaut est l'adresse IP de ce périphérique.

- Il n'est pas nécessaire de configurer l'adresse d'une passerelle si vous utilisez DHCP ou AutoIP.
- Pour plus d'informations sur les passerelles, contactez votre administrateur réseau.
- Ce paramètre est non volatile ; il n'est pas modifié par une remise sous tension ou l'exécution de la commande **\*RST**.
- **Face avant :**

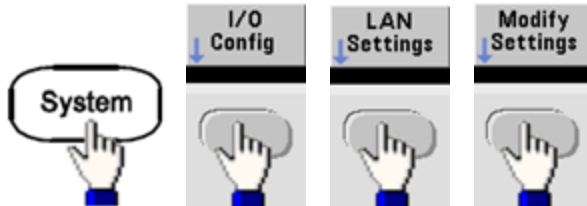

Enfin, configurez la première touche de fonction sur **Manual**, puis appuyez sur **More** et **Gateway**. Configurez ensuite l'adresse correcte de la passerelle à l'aide du clavier numérique ou du bouton.

- **SCPI:** `SYSTem:COMMunicate:LAN:GATeway "<adresse>"`

### Nom d'hôte

Un nom d'hôte est la partie concernant l'hôte dans le nom du domaine qui est traduite en adresse IP.

- L'instrument reçoit en usine un nom d'hôte unique que vous pouvez modifier. Ce nom doit être unique sur le réseau.
- Le nom doit commencer par une lettre ; les autres caractères peuvent être des majuscules ou des minuscules, des chiffres ou le caractère de soulignement (« - »).
- Ce paramètre est non volatile ; il n'est pas modifié par une remise sous tension ou l'exécution de la commande **\*RST**.
- **Face avant :**

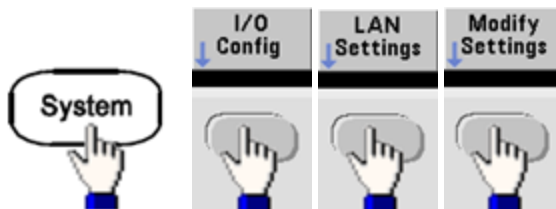

Enfin, appuyez sur **Host Name** et entrez le nom d'hôte à l'aide du bouton et des flèches. Le bouton permet de modifier le caractère ; les flèches du curseur permettent de parcourir les caractères.

- **SCPI:** `SYSTem:COMMunicate:LAN:HOSTname "<nom>"`

## Consignes d'utilisation

### Nom de domaine

Un nom de domaine est un nom Internet enregistré qui est traduit en adresse IP. Il n'est pas possible de le configurer sur la face avant ou à l'aide d'une commande SCPI.

### Serveur DNS

DNS (Domain Name Service) est un service Internet qui traduit les noms de domaines en adresses IP. L'adresse du serveur DNS est l'adresse IP d'un serveur qui fournit ce service.

- En règle générale, DHCP recherche les informations sur l'adresse DNS. Il vous suffit d'indiquer si le protocole DHCP est inutilisé ou non fonctionnel. Pour plus d'informations sur le serveur DNS, contactez votre administrateur réseau.
- Ce paramètre est non volatile ; il n'est pas modifié par une remise sous tension ou l'exécution de la commande **\*RST**.
- **Face avant :**

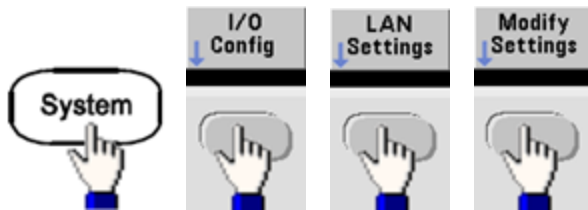

Enfin, configurez la première touche de fonction sur **Manual**, puis appuyez sur les touches **More** et **Primary DNS** ou sur la touche **Second DNS** pour saisir une adresse DNS à l'aide du clavier numérique ou du bouton.

- **SCPI:** `SYSTem:COMMunicate:LAN:DNS[1|2] "<adresse>"`

### Configuration active (réseau local)

- Sélectionnez l'écran Paramètres actuellement activés pour afficher l'adresse MAC et la configuration active du réseau local.



- **Face avant :**
- **SCPI :** (Aucune commande équivalente)

L'écran présente uniquement les paramètres actuellement activés lors de l'affichage initial. Il ne met pas à jour les modifications ultérieures. Par exemple, si le protocole DHCP affecte une adresse IP avec l'écran ouvert, la nouvelle adresse ne s'affiche pas.

Si l'instrument passe en mode distant, toutes les modifications du réseau local sont annulées et un autre écran s'affiche. La nouvelle sélection de la page Paramètres LAN entraîne l'affichage des nouveaux paramètres si un redémarrage du réseau a été effectué.

Pour obtenir une liste des commandes supplémentaires de configuration du réseau local, reportez-vous à la section [Présentation au Sous-système SYSTem](#).

## Interface Web

L'instrument inclut une interface Web intégrée que vous pouvez utiliser sur le réseau local pour l'accès et le contrôle à distance de l'instrument via un navigateur Java™ tel que Microsoft Internet Explorer.

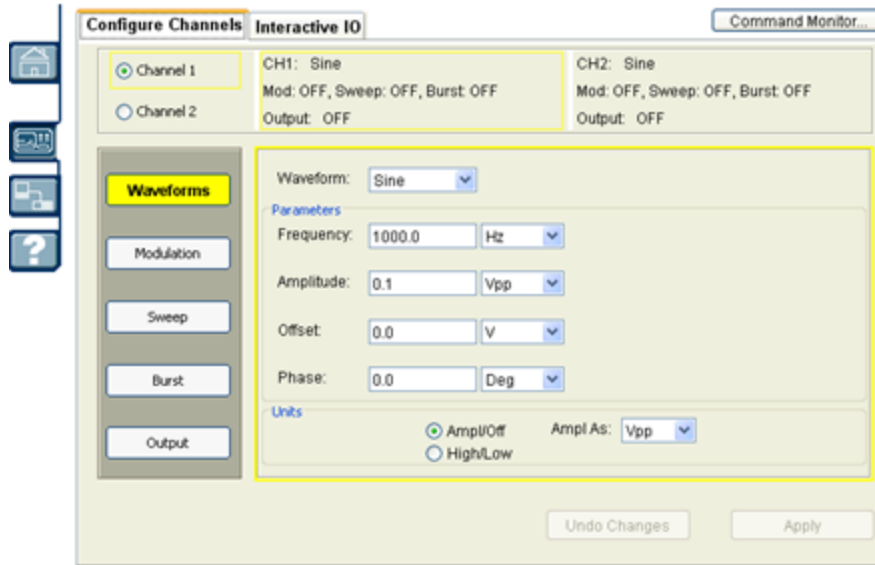

Pour utiliser l'interface Web :

1. Sur votre PC, établissez une connexion à l'instrument sur le réseau local.
2. Ouvrez le navigateur Web sur votre PC.
3. Lancez l'interface Web de l'instrument : entrez l'adresse IP de l'instrument ou le nom d'hôte dans le champ d'adresse du navigateur.
4. Suivez les instructions de l'aide en ligne de l'interface Web.

## Configuration USB

Face avant :

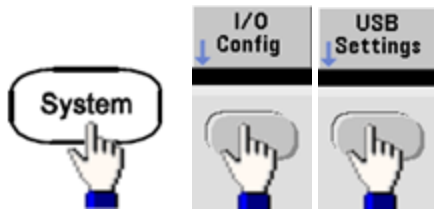

La série 33500 n'inclut aucun paramètre USB pouvant être configuré par l'utilisateur. Vous ne pouvez extraire la chaîne d'identification USB (configurée par le fabricant) qu'à l'aide de la touche de fonction **Show USB Id**.

**File Access** (série 33600 uniquement)

La fonction **File Access** utilise le protocole de transfert de fichiers multimédia (MTP) pour télécharger facilement les fichiers de l'appareil vers votre ordinateur. Connectez simplement le port USB de la face arrière de l'instrument à un port USB de votre PC. Le multimètre s'affiche comme lecteur en lecture seule sur le système de fichiers de votre PC. Notez que la mémoire interne de l'instrument inclut une structure de répertoires prédéfinis, illustrée ci-dessous.

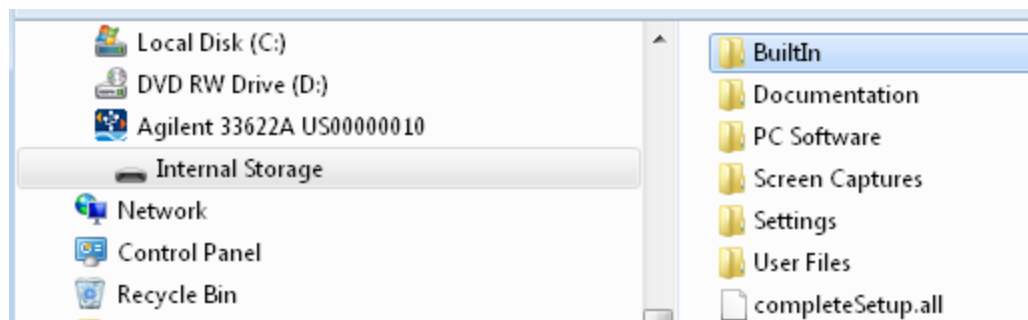

Vous pouvez utiliser les fonctionnalités standard de gestion de fichiers de votre PC pour copier des fichiers du multimètre sur votre ordinateur.

**REMARQUE** Pour utiliser la fonction **File Access** en même temps que vous programmez l'instrument à distance avec SCPI sur l'interface USB (**USB SCPI**), vous devez installer Keysight IO Libraries Suite 16.3 ou version ultérieure sur votre PC. Vous pouvez télécharger la dernière version à l'adresse [www.keysight.com/find/iosuite](http://www.keysight.com/find/iosuite).

Pour utiliser l'option File Access sur un ordinateur exécutant le système d'exploitation Windows XP, assurez-vous d'installer Microsoft Windows Media Player 11 pour Windows XP ou version ultérieure avant de brancher le câble USB. Vous pouvez télécharger ce logiciel à l'adresse [www.microsoft.com/en-us/download/details.aspx?id=8163](http://www.microsoft.com/en-us/download/details.aspx?id=8163).

## Référence de base de temps externe

**AVERTISSEMENT** Le connecteur BNC d'entrée de référence 10 MHz situé sur la face arrière de l'instrument est isolé jusqu'à  $\pm 42$  V crête du châssis. Le boîtier de ce connecteur BNC est isolé du reste de l'instrument. La circuiterie interne tentera de maintenir la tension isolée dans les limites de  $\pm 42$  V crête par rapport au châssis. Toute tentative de configuration de cette entrée au-delà de  $\pm 42$  V crête du châssis peut détruire l'instrument et provoquer des risques de blessures graves, voire mortelles.

La référence de base de temps externe permet aux connecteurs de la face arrière (**10 MHz In** et **10 MHz Out**) et aux circuits de synchroniser plusieurs instruments ou de synchroniser l'instrument avec un signal d'horloge externe 10 MHz. Vous pouvez également configurer le déphasage du signal de sortie sur la face avant ou l'interface distante.

Pour mettre deux instruments en phase, utilisez un oscilloscope 2 voies pour comparer les signaux de sortie :

1. Connectez les 2 instruments avec la sortie **10 MHz** raccordée à l'entrée **10 MHz**. Utilisez l'instrument avec la base de temps plus précise comme source de sortie de référence 10 MHz.

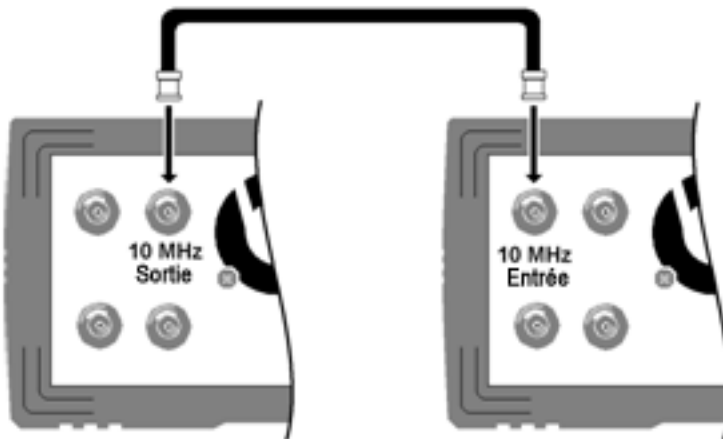

2. Connectez les sorties de l'instrument aux entrées de l'oscilloscope :

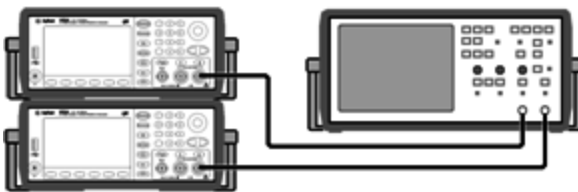

3. Réglez les deux instruments sur la même fréquence. L'oscilloscope doit afficher les signaux synchronisés en fréquence, mais déphasés (un signal carré suffit pour illustrer le déphasage).

4. Pour les instruments 2 voies, synchronisez la phase des 2 voies. Les signaux modulants de chaque voie sont également synchronisés avec le signal porteur.

Face avant :

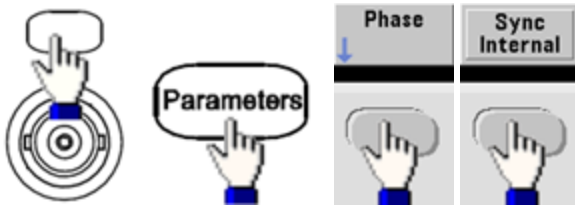

SCPI: `[SOURCE[1|2]:]PHASe:SYNChronize`

5. En conservant le réglage de phase par défaut (zéro) sur le premier instrument, utilisez l'option **Adjust Phase** pour régler la phase du deuxième instrument afin d'aligner les signaux de sortie :

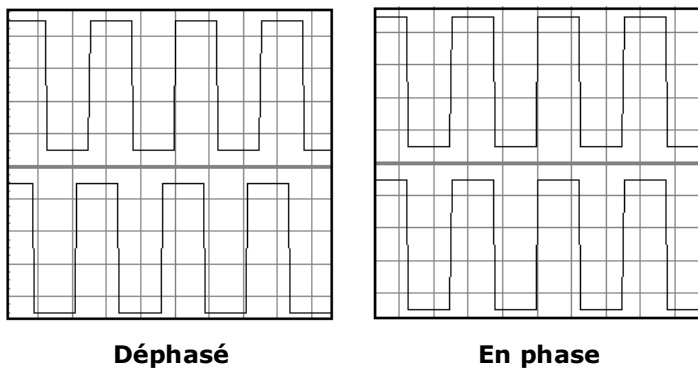

Vous pouvez utiliser l'option **Set 0 Phase** pour configurer un nouveau point de référence de phase nulle lorsque les 2 instruments sont en phase.

- Face avant :



Définissez l'angle de phase à l'aide du clavier ou du bouton. Une fois les signaux en phase, appuyez sur **Set 0 Phase**.

- SCPI:

`[SOURCE[1|2]:]PHASe {<angle>|MINimum|MAXimum|DEFault}`

`[SOURCE[1|2]:]PHASe:REFerence`



## Éditeur de signaux intégré

L'instrument inclut un éditeur de signaux intégré qui permet de créer et de modifier des signaux arbitraires sur une voie en signaux arbitraires ASCII (extension .ARB). Vous pouvez saisir et modifier des tensions directement ou en combinant jusqu'à 12 types de signaux standard différents, décrits dans les sections suivantes :

[Signaux standard](#)

[Notions de base sur la modification de signaux](#)

[Advanced Edit](#)









[Advanced Math](#)

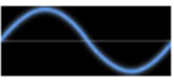

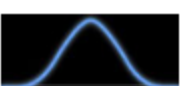

[Menu Utility](#)

**REMARQUE** Quelles que soient les options installées, la taille de signal maximale pour l'éditeur de signaux intégré est de 1 Méch.

### Signaux standard

L'éditeur de signaux intégré inclut les 12 signaux suivants :

Sinusoïdal		$y = \sin(x)$
Carré		Signal carré qui alterne entre deux niveaux de tension
Rampe		Signal présentant une tension croissant ou décroissant de façon linéaire
Ligne		Segment de ligne
CC		Tension continue
Bruit		Bruit aléatoire
Gaussien		Courbe de Gauss (distribution normale)
Sinc		$y = \sin(x)/x$

D-Lorentz		Dérivée de la fonction de Lorentz. La fonction de Lorentz correspond à $y = 1/(x^2+1)$ ; sa dérivée est donc $y = -2x/(x^2+1)^2$ .
Croissance exponentielle		Décroissance exponentielle : $y = e^{-kx}$
Croissance exponentielle		Croissance exponentielle : $y = 1 - e^{-kx}$
Demi-sinus inverse (Haversine)		$y = [1 - \cos(x)]/2$

## Consignes d'utilisation

Lorsque vous sélectionnez un signal, l'instrument présente un écran qui permet de spécifier ses paramètres correspondants, répertoriés ci-dessous.

Amplitude	Hauteur maximale au-dessus de 0 V lorsque la tension résiduelle du signal est nulle, comprise entre 10 $\mu$ V et 10 V (par défaut 1).
Tension résiduelle	Décalage du signal vers le haut ou le bas par rapport à la tension de 0 V, compris entre -10 et 10 V (par défaut 0).
La somme de l'amplitude et de la tension résiduelle doit être comprise entre -10 V et + 10 V.	
Phase	Angle en degrés d'avance (valeur positive) ou de retard (valeur négative) du signal par rapport à la référence 0 degré, compris entre -360 et 360 (par défaut 0).
Cycles	Nombre de cycles de sortie exécutés (entier positif) dans le signal.
Points	Nombre de points inclus dans le signal, maximum de 1 000 000 points (par défaut 100). La série 33500 inclut un nombre minimal de 8 points, alors que la série 33600 comporte au minimum 32 points.
Demi-largeur (D-Lorentz uniquement)	Valeur qui contrôle la largeur du signal. Plus cette valeur est élevée, plus les courbes sont larges. Entier compris entre 1 et le nombre total de points dans un cycle (par défaut 10).
Facteur de décroissance (Décroissance exponentielle uniquement)	Nombre décimal compris entre -99 et 99 qui contrôle la vitesse de croissance ou de décroissance du signal (par défaut -5).
Facteur de croissance (Croissance exponentielle uniquement)	
Pleine largeur (Courbe de Gauss uniquement)	Largeur de la courbe de Gauss entre les points de la courbe égaux à la moitié de la hauteur de la courbe, de 1 au nombre de points dans un cycle (par défaut 10).
Symétrie (Rampe uniquement)	Temps en pourcentage (par période de cycle) de croissance de la rampe ; nombre décimal compris entre 0 et 100 (par défaut 100).
Passage au zéro (Sinc uniquement)	Nombre de fois que le signal coupe l'axe horizontal d'un côté du signal ; nombre compris entre 0 et 100 (par défaut 10).
Rapport cyclique (Carré uniquement)	Temps en pourcentage (par période de cycle) pendant lequel la tension du signal est haute ; nombre compris entre 0 et 100 (par défaut 50).

Niveau initial (Ligne uniquement)	Tension au début ou à la fin du segment de ligne.
Niveau final (Ligne uniquement)	

### Notions de base sur la modification de signaux

Lorsque vous démarrez l'éditeur de signaux intégré ([Waveforms] > Arb > Arbs > Edit Arb File > New Arb File), l'écran de démarrage s'affiche. (Notez que le même menu contenant la touche de fonction **Edit Arb File** inclut également une touche de fonction appelée **Import Data**. Vous pouvez l'utiliser pour importer des fichiers ASCII d'oscilloscopes et d'autres instruments courants).

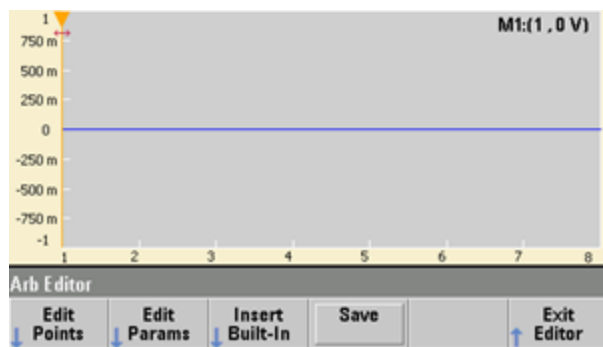

La touche **Edit Points** vous permet de modifier les valeurs de tension de points individuels du signal. Vous pouvez également insérer et supprimer des points du signal et accéder aux fonctions de modification avancée **Advanced Edit**, décrites ci-dessous. L'image à l'écran représente le nouveau signal arbitraire par défaut composé de 8 points à 0 Vcc.

**REMARQUE** La taille par défaut d'un signal arbitraire est de 8 points sur la série 33500 et de 32 points sur la série 33600.

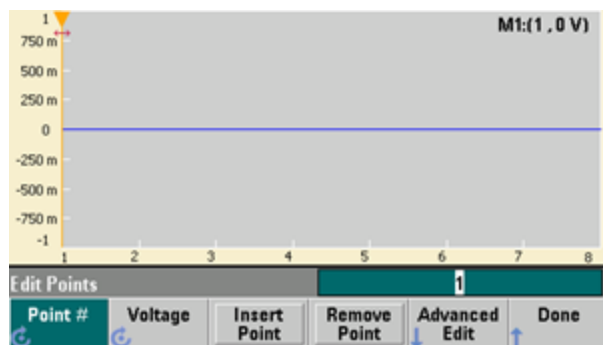

## Consignes d'utilisation

La touche **Edit Params** vous permet de définir la fréquence d'échantillonnage du signal, qui correspond à la vitesse de lecture du signal (en points par seconde). Vous pouvez spécifier cette grandeur en fréquence ou en période. Si vous en modifiez une, l'autre est recalculée en fonction du nombre de points présents dans le signal. Cette fonction permet d'indiquer si le signal est exprimé en unité de temps ou en nombre de points sur l'axe horizontal.

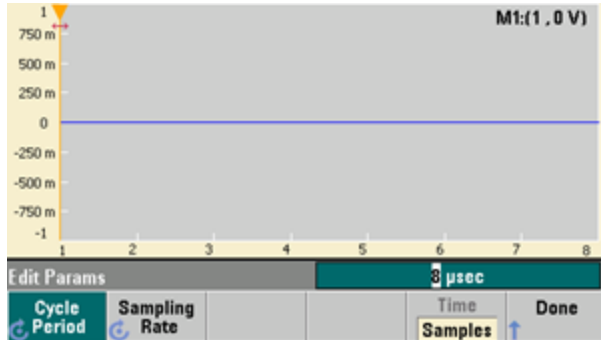

La touche **Insert Built-In** vous permet d'introduire l'un des 12 signaux prédéfinis dans le signal actif.

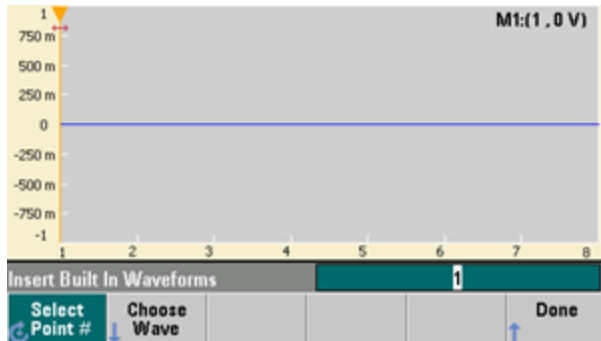

La touche **Select Point #** vous permet de spécifier l'emplacement d'insertion du signal et la touche de fonction **Choose Wave** vous permet de spécifier le signal à insérer parmi 12 types prédéfinis.

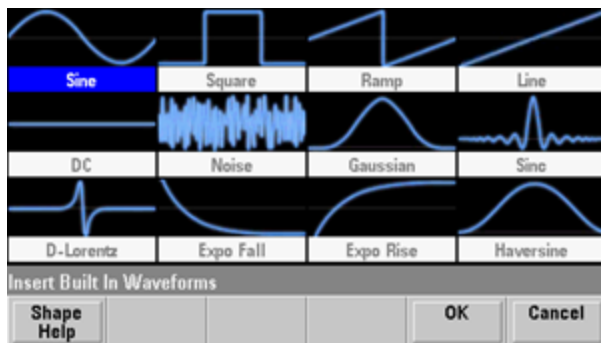

Après avoir utilisé les touches fléchées pour sélectionner le signal à insérer et appuyé sur **OK**, l'instrument affiche les paramètres du signal à insérer. Sélectionnez les paramètres à modifier à l'aide des touches fléchées haut/bas. Spécifiez ces paramètres et appuyez sur **OK**.

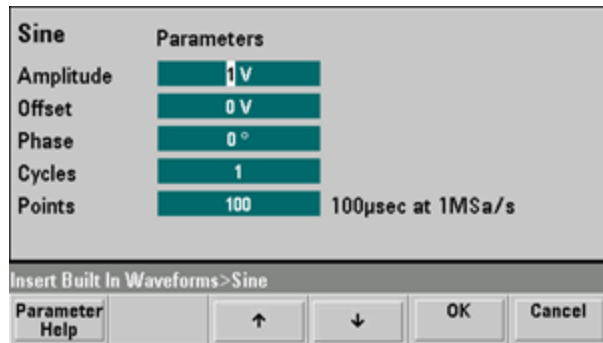

La touche **Save** vous permet d'enregistrer le signal actif à son emplacement actuel dans la mémoire interne de l'instrument.

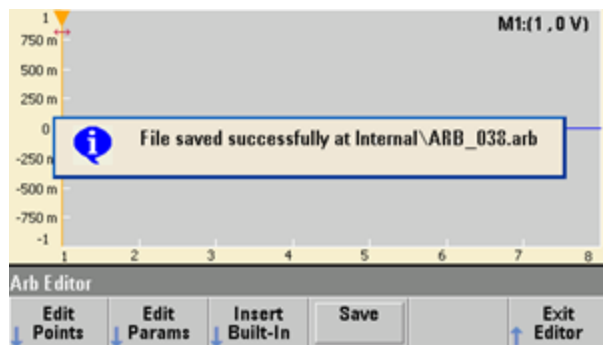

La touche **Exit Editor** permet de fermer l'éditeur et de retourner à un mode de fonctionnement normal.



Si des modifications n'ont pas été enregistrées, un message vous donne la possibilité de rester dans l'éditeur de signaux intégré. Après avoir quitté l'éditeur, vous pouvez lire le signal dans le générateur de signaux.

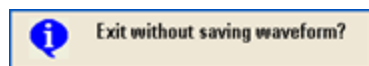

### Advanced Edit

Comme indiqué ci-dessus, le menu **Edit Points** inclut la touche de fonction **Advanced Edit**. Cette touche vous permet de couper, copier et coller des parties du signal, de modifier des points de signal dans un tableau et d'effectuer des opérations mathématiques sur le signal.

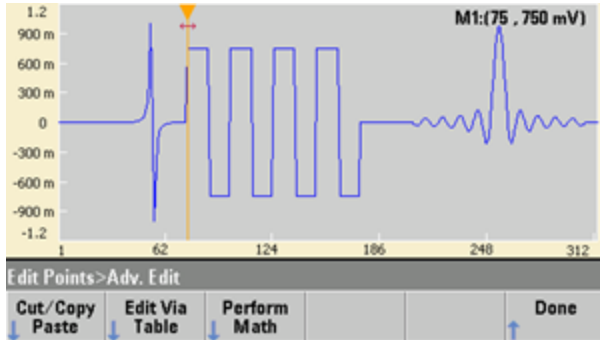

La touche **Cut/Copy/Paste** vous permet de définir une plage du signal entre 2 marqueurs, et de couper ou de copier des points du signal définis par les marqueurs. Après avoir coupé ou copié cette plage, vous pouvez la coller autant de fois que vous le désirez à l'aide de la touche de fonction **Paste**.



La touche **Paste Location** vous permet de coller une plage au début ou à la fin du signal, ou à un point quelconque du signal.

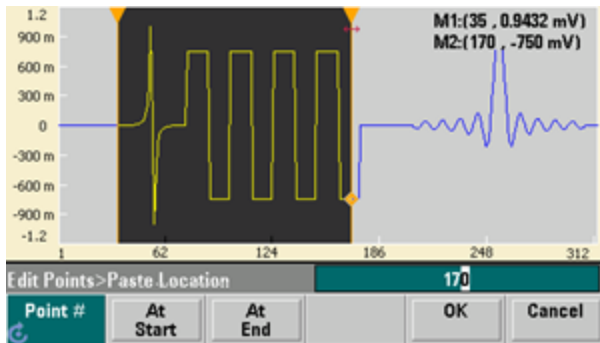

La touche **Edit Via Table** vous permet de modifier les valeurs de tension de points individuels dans un tableau. Vous pouvez utiliser le bouton pour parcourir le tableau ou bien la touche de fonction **Point #** pour sélectionner directement un point donné. Vous pouvez également insérer ou supprimer des points du signal.

Point No. (Max 312)	Voltage Value (Volts)
1	0.00000
2	0.00000
3	0.00000
4	0.00000
5	0.00006
6	0.00006
7	0.00007
8	0.00007

Edit Points>Table

Point # Voltage Insert Point Remove Point Done

La touche **Perform Math** vous permet d'utiliser des marqueurs pour spécifier une plage dans un signal. Vous pouvez ensuite ajouter, soustraire ou multiplier les valeurs de tension par les valeurs de tension d'un autre signal.

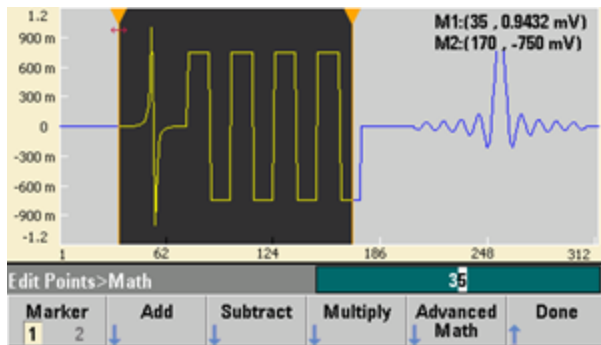

Après avoir appuyé sur **Add**, **Subtract** ou **Multiply**, l'instrument affiche une liste de signaux. Sélectionnez le signal, puis appuyez sur **OK**.





## Consignes d'utilisation

Lorsque vous appuyez sur **OK**, l'instrument affiche une liste de paramètres que vous pouvez utiliser pour spécifier le signal. Dans ce cas, l'écran ci-dessous indique que vous avez sélectionné **D-Lorentz**. Vous pouvez également utiliser les paramètres **From Point** et **To Point** pour spécifier la plage de points sur lesquels effectuer l'opération mathématique.

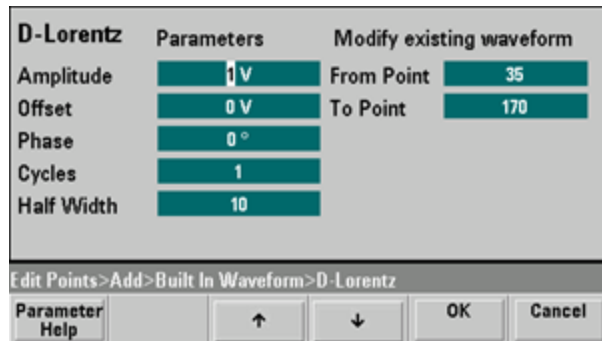

## Advanced Math

La touche **Advanced Math** vous permet d'effectuer divers types d'opérations mathématiques sur le signal. Pour commencer, appuyez sur **Edit Points > Advanced Edit > Perform Math > Advanced Math**.

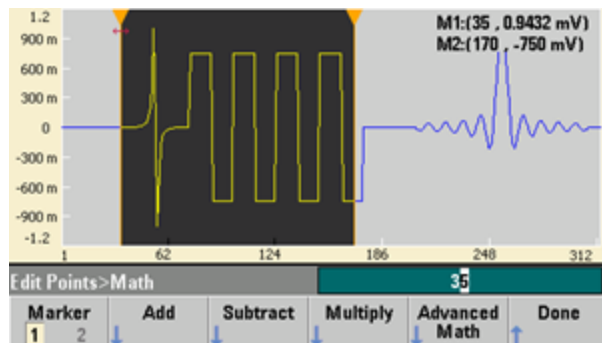

Le menu **Advanced Math** s'ouvre avec l'écran suivant. Chaque opération illustrée ci-dessous est décrite par des images capturées avant et après chaque opération pour démontrer ses résultats.

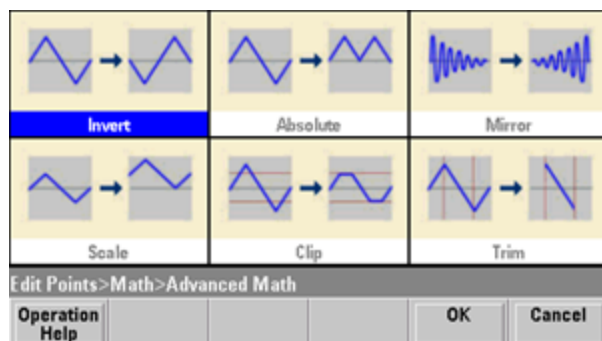

La fonction **Invert** inverse le signal sur l'axe horizontal.

Avant l'exécution de la fonction Invert

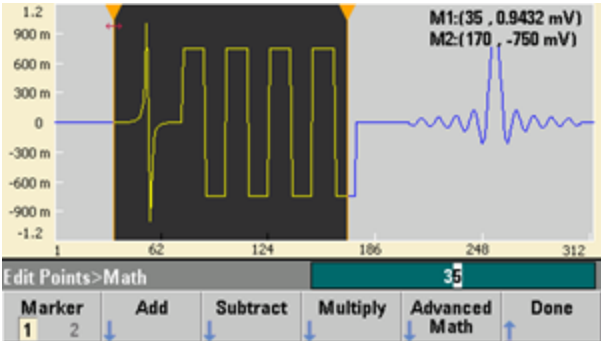

Après l'exécution de la fonction Invert

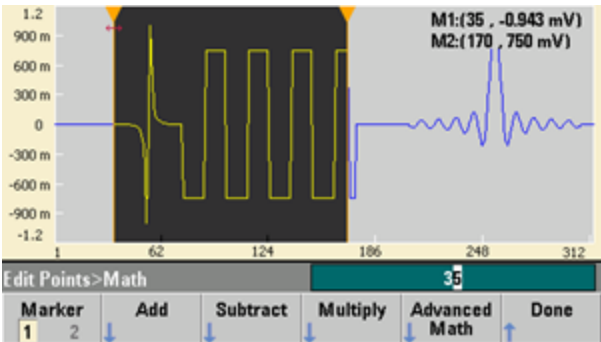

## Consignes d'utilisation

La fonction **Absolute** multiplie toutes les valeurs négatives par -1.

Avant l'exécution de la fonction Absolute

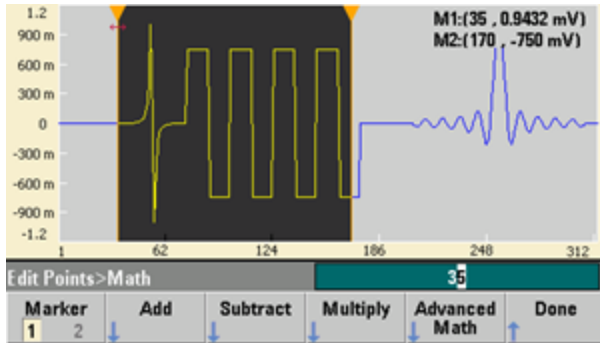

Après l'exécution de la fonction Absolute

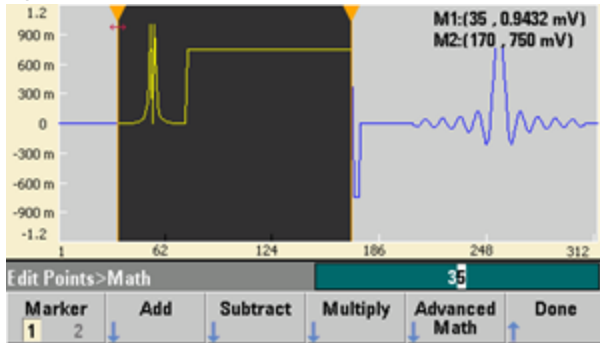

La fonction **Mirror** inverse les points dans la plage.

Avant l'exécution de la fonction Mirror

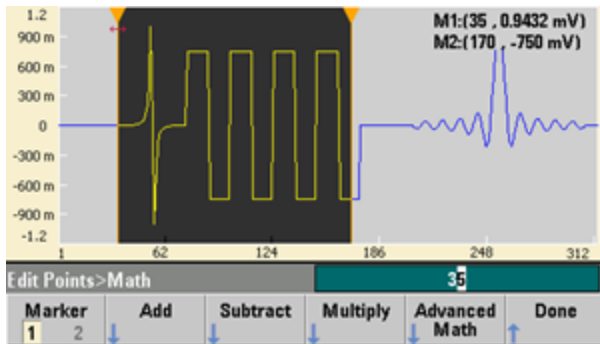

Après l'exécution de la fonction Mirror

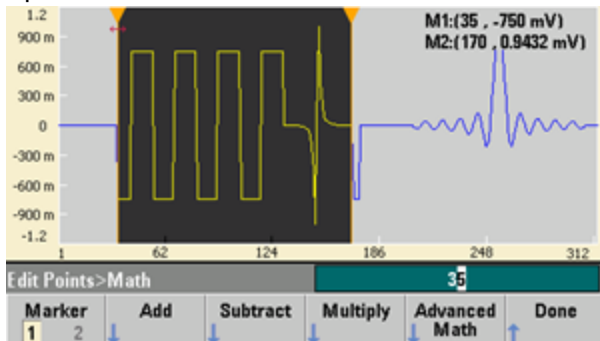

La fonction **Scale** vous permet de mettre à l'échelle l'amplitude et la tension résiduelle du signal. Ici, l'échelle de l'amplitude a été définie à 180 % et l'échelle de la tension résiduelle a été définie à 1 V.

Avant l'exécution de la fonction Scale

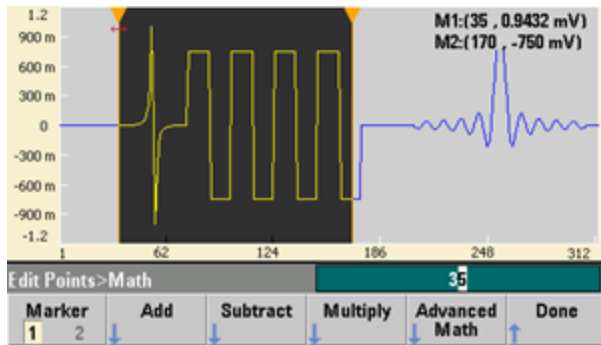

Après l'exécution de la fonction Scale

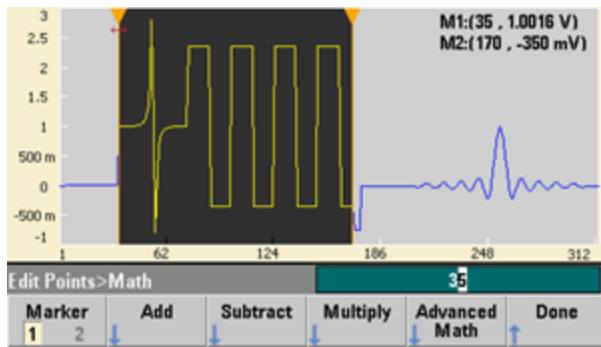

## Consignes d'utilisation

La fonction **Clip** vous permet de modifier les valeurs de tension en dehors des limites inférieure et supérieure afin qu'elles soient égales aux limites. Dans cet exemple, le signal a été tronqué pour rester entre la limite inférieure de -400 mV et la limite supérieure de 700 mV.

Avant l'exécution de la fonction Clip

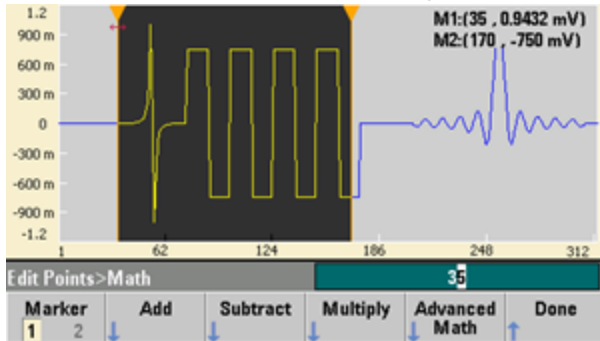

Après l'exécution de la fonction Clip

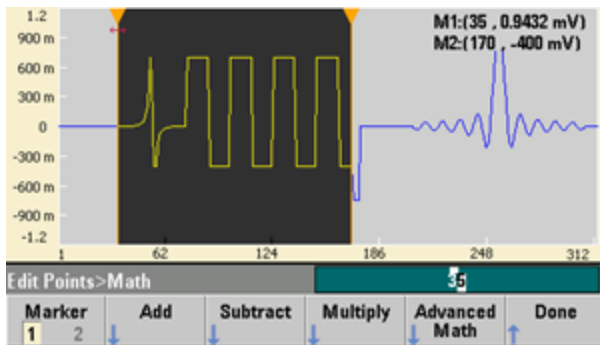

La fonction **Trim** vous permet d'utiliser des marqueurs pour « rogner » le signal de façon que seuls les points définis par les marqueurs restent dans le signal.

Avant l'exécution de la fonction Trim

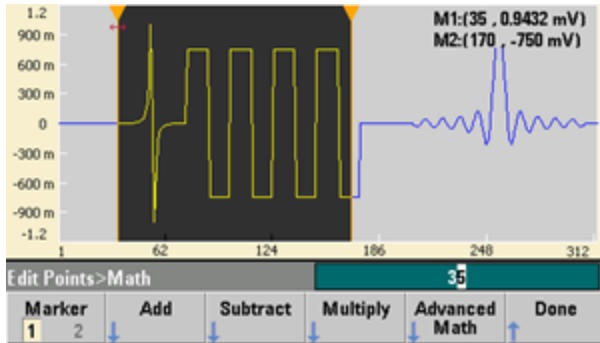

Après l'exécution de la fonction Trim

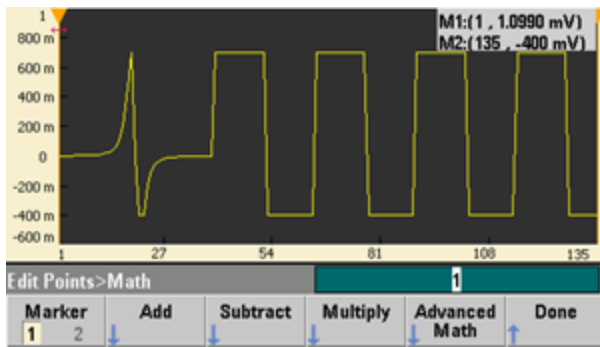

## Menu Utility

Appuyez sur la touche **[System]** de l'éditeur de signaux intégré pour accéder à plusieurs fonctions utiles.



La touche **Undo** vous permet d'annuler les opérations récentes en fonction de la mémoire disponible et de l'ampleur de l'annulation. La touche **Redo** vous permet de rétablir les opérations annulées selon certaines limitations.

La touche **Pan/Zoom Control** vous permet de parcourir ou d'agrandir horizontalement ou verticalement. L'agrandissement utilise un facteur de zoom en pourcentage ; l'examen panoramique requiert la saisie d'un point ou d'une tension.

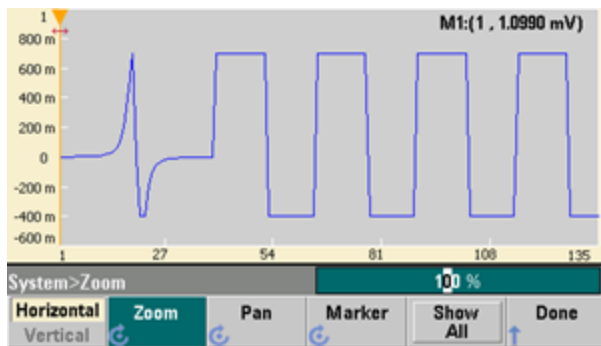

La touche **Show All** permet de réinitialiser le facteur d'échelle pour afficher le signal complet.

## Didacticiel de génération de signaux

Cette section contient des informations sur les principes d'utilisation de divers types de signaux et de modes de fonctionnement de l'instrument. Les deux dernières rubriques contiennent des informations susceptibles de vous aider à améliorer la qualité des signaux.

- **Signaux arbitraires**
- **Bruit quasi-gaussien**
- **PRBS**
- **Modulation**
- **Rafale**

- Balayage en fréquence
- Attributs des signaux CA
- Imperfections des signaux
- Boucles de masse

## Signaux arbitraires

Les signaux arbitraires peuvent répondre à certains besoins non satisfaits par les signaux standard de l'instrument. Par exemple, vous aurez peut-être besoin d'une seule impulsion ou souhaitez simuler des imperfections dans un signal (par ex., suroscillation, oscillations, parasites ou bruit). Les signaux arbitraires, qui peuvent être très complexes, sont adaptés à la simulation des signaux rencontrés dans les systèmes modernes de communication.

Vous pouvez créer des signaux arbitraires à partir de 8 points au minimum (série 33500) ou de 32 points (série 33600) jusqu'à 1 000 000 points. L'instrument mémorise les valeurs numériques correspondant à ces points (échantillons) et les convertit en tensions lorsque le signal est généré. La fréquence de lecture des points est la « fréquence d'échantillonnage » ; la fréquence du signal est égale à la fréquence d'échantillonnage divisée par le nombre de points dans le signal. Par exemple, supposons qu'un signal comporte 40 et que la fréquence d'échantillonnage soit de 10 MHz. La fréquence est alors  $(10 \text{ MHz})/40 = 250 \text{ kHz}$ , d'où une période de 4  $\mu\text{s}$ .

## Signaux arbitraires doubles

Les signaux arbitraires peuvent être présents sur une voie, ou (avec l'option IQP) sur deux voies (par ex., signaux en bande de base IQ). Un double signal arbitraire est analogue à un fichier audio stéréo. Il comporte deux canaux d'informations qui contiennent le même nombre d'échantillons, commencent et se terminent toujours ensemble et sont toujours lus à la même fréquence d'échantillonnage.

Vous pouvez contrôler le déphasage et l'équilibre entre les voies de signaux arbitraires doubles via les commandes du sous-système SCPI FUNCTION ou la face avant.



## Filtres des signaux

L'instrument comporte deux filtres de signaux qui lissent les transitions entre les points lorsque des signaux arbitraires sont générés.

- Filtre normal : fournit une réponse en fréquence plate étendue. Cependant, sa réponse aux transitoires présente une oscillation transitoire et une suroscillation.
- Filtre à paliers : fournit une réponse quasi-idéale aux transitoires, mais présente une oscillation plus importante dans la réponse en fréquence que le filtre normal.
- Désactivé : la sortie change brusquement entre les points avec un temps de transition d'environ 10 ns.

La fréquence de coupure de chaque filtre est une fraction constante de la fréquence d'échantillonnage du signal. La réponse du filtre normal est de -3 dB à 27 % de la fréquence d'échantillonnage, tandis que la réponse du filtre à paliers est de -3 dB à 13 % de la fréquence d'échantillonnage. Par exemple, pour un signal arbitraire à 100 M.éch/s, la fréquence de la bande passante de -3 dB du filtre Normal est de 27 MHz.

La désactivation du filtre peut modifier la fréquence d'échantillonnage à une valeur inférieure si la fréquence était supérieure à 250 M.éch/s avant la désactivation.

## Applications de séquençement des signaux

Les séquences de signaux arbitraires sont utiles lorsque le signal à générer répond à deux cas de figure :

- Le signal est très long et contient des répétitions de fragments plus courts. Ces fragments peuvent être répétés un nombre illimité de fois dans n'importe quel ordre.
- Vous nécessitez d'un contrôle en temps réel (déclencheurs) pour passer d'un fragment de signal à un autre.

Pour un exemple du premier cas, supposons un signal qui doit lire le même signal initial plusieurs fois, puis lire trois autres signaux une fois chacun avant de relire le premier signal en continu. Il peut s'agir d'un paquet de données de modem simulé comprenant un signal « inactif », un en-tête, quelques données, une somme de contrôle et un retour au signal « inactif ».

Ce cas peut comprendre la description de séquence suivante :

1. Lire « idle.arb » à 10 reprises
2. Lire « header.arb » une fois
3. Lire « data.arb » une fois
4. Lire « checksum.arb » une fois
5. Lire « idle.arb », répété indéfiniment.

Dans le deuxième cas, vous souhaitez démarrer l'envoi de « header.arb » à l'aide d'un déclencheur matériel externe. Ce cas peut utiliser la description suivante :

1. Lire « idle.arb » de façon répétée jusqu'à la réception d'un signal déclencheur
2. Lire « header.arb » une fois
3. Lire « data.arb » une fois
4. Lire « checksum.arb » une fois
5. Lire « idle.arb », répété indéfiniment.

Un fichier de séquence (\*.seq) contient les informations dans des listes numérotées, alors que les fichiers de signaux arbitraires (\*.arb) contient les signaux individuels mêmes.

### Mise en œuvre du séquençement de signaux

L'instrument peut regrouper des séquences longues et complexes de signaux arbitraires (segments). La commutation entre les segments a lieu en douceur et en temps réel. Par analogie, pensez aux segments comme des morceaux dans un appareil de lecture de musique et aux séquences comme des listes de lecture.

Chaque partie d'une séquence spécifie un segment et le nombre de fois qu'il est lu. Elle indique également si la séquence attend un signal déclencheur avant la partie suivante et comment le signal **Sync** est généré étape par étape.

Pour chaque segment, vous pouvez :

- lire le segment entre 1 et 1 000 000 fois et passer ensuite à l'étape suivante
- lire le segment une fois, puis arrêter et attendre un signal déclencheur avant de continuer
- répéter le segment jusqu'à ce qu'un déclenchement se produise, puis continuer
- répéter le segment jusqu'à son arrêt explicite

Options de génération du signal **Sync** :

- Évaluer le signal **Sync** au début du segment
- Ignorer le signal **Sync** au début du segment
- Conserver la configuration actuelle du signal **Sync** dans tout le segment
- Évaluer le signal **Sync** au début du segment et l'ignorer à un point défini dans le segment

Pour démarrer une séquence à la réception d'un signal déclencheur, placez un signal CC bref de 0 V (ou toute autre valeur désirée) à l'avant des autres signaux de la séquence, et configurez le segment afin qu'il attende un signal déclencheur avant de continuer. Pour les instruments de la série 33500, la longueur de segment minimale est de 8 éch. Pour les instruments de la série 33600, la longueur de segment minimale est de 32 éch.

**REMARQUE** Si un segment est configuré pour se répéter jusqu'à la réception d'un signal déclencheur, il se termine toujours avant de passer au segment suivant. De plus, un segment court peut se répéter pour d'autres cycles afin d'effacer le tampon d'échantillons de séquences avant de continuer.

## Bruit quasi-gaussien

Le signal de bruit est optimisé pour les propriétés statistiques quantitatives et qualitatives. Il ne se répète pas sur une période supérieure à 50 ans de fonctionnement continu. À la différence d'une vraie distribution gaussienne, la probabilité d'obtenir une tension inférieure au réglage  $V_{pp}$  de l'instrument est nulle. Le facteur de crête (tension en crête divisée par la tension efficace) est approximativement de 4,6.

Vous pouvez faire varier la bande passante du bruit de 1 MHz à la bande passante maximale de l'instrument. L'énergie contenue dans le signal de bruit est concentrée entre le courant continu et la bande passante sélectionnée, de façon que la densité spectrale du signal soit plus importante dans la bande d'intérêt lorsque la bande passante est configurée avec une valeur faible. Dans les travaux audio, par exemple, vous souhaitez peut-être configurer la bande passante à 30 kHz de façon que la force du signal dans la bande audio soit 30 dB supérieure à la bande passante configurée à 30 MHz.

## PRBS

Une séquence binaire pseudo aléatoire (PRBS) comporte deux niveaux (haut et bas) et bascule entre eux d'une manière difficilement prévisible sans connaître l'algorithme de génération de la séquence. Un registre à décalage à rétroaction linéaire (LFSR) génère une séquence PRBS, illustrée ci-dessous.

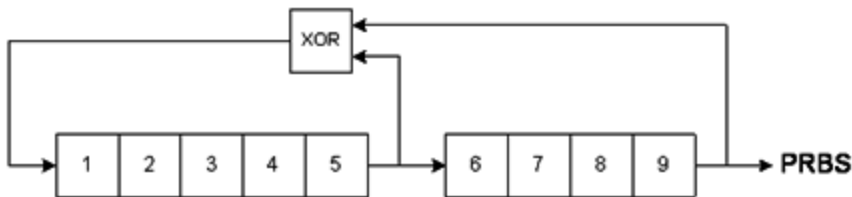

Un registre à décalage à rétroaction linéaire (LFSR) est spécifié par le nombre d'étages qu'il contient et les étages (piquages) en entrée des portes XOR (OU exclusif) dans son réseau de rétroaction. La sortie PRBS provient du dernier étage. Avec des piquages correctement choisis, un registre LFSR à étage en  $L$  produit un signal PRBS répétitif de longueur  $2^L - 1$ . La fréquence d'horloge du registre LFSR détermine le « débit binaire » du signal PRBS.

Les modèles de la série 33500 vous permettent de configurer  $L$  sur les valeurs 7, 9, 11, 15, 20 ou 23, ce qui engendre des séquences d'une longueur comprise entre 127 et 8 388 607 bits.

Les modèles de la série 33600 vous permettent de configurer  $L$  sur toute valeur numérique comprise entre 3 et 32, générant ainsi des séquences d'une longueur comprise entre 7 et 4 294 967 295 bits.

La valeur par défaut de  $L$  est 7, produisant une séquence d'une longueur de 127 bits.

## Modulation

### Modulation d'amplitude (AM)

L'instrument met en place deux formes de modulation d'amplitude :

- La modulation à double bande latérale à signal porteur complète (DSB-FC), désignée dans la norme ITU par le sigle A3E et utilisée dans la radiodiffusion AM.

L'équation de la modulation DSB-FC se présente comme suit :

$$y(t) = [(1/2) + (1/2) \cdot d \cdot m(t)] \cdot A_c \cdot \sin(\omega_c t)$$

où

$m(t)$  correspond au signal modulant

$A_c$  correspond à l'amplitude du signal porteur

$\omega_c$  correspond à la fréquence du signal porteur

$d$  correspond à la « profondeur de modulation » ou une fraction de l'amplitude est utilisée par la modulation

Par exemple, une profondeur de 80 % fait varier l'amplitude de 10 % à 90 % de l'amplitude configurée (90 % - 10 % = 80 %) avec un signal modulant interne ou externe en pleine échelle ( $\pm 5$  V sur la série 33500,  $\pm 5$  V ou  $\pm 1$  V sur la série 33600). Vous pouvez configurer une profondeur de 120 % dès lors que vous ne dépassez pas la tension de sortie maximale de l'instrument ( $\pm 5$  V dans une charge de 50  $\Omega$ ,  $\pm 10$  V dans une charge de haute impédance).

La trace supérieure représente le signal modulant, alors que la trace inférieure représente le signal porteur modulé.

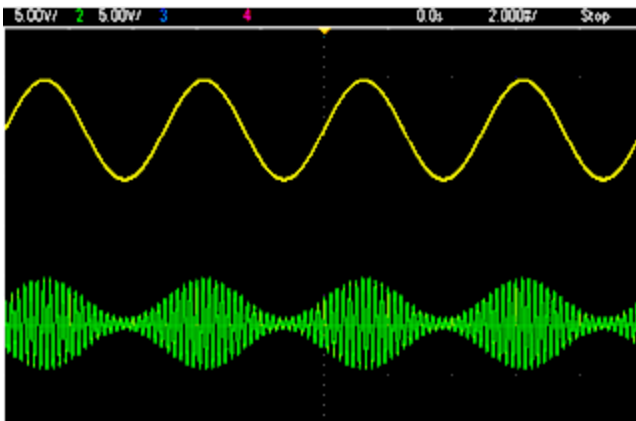

- La modulation à double bande latérale à suppression de signal porteur (DSSC) De nombreux systèmes de communication modernes utilisent la modulation DSSC sur chacun des deux signaux porteurs de même fréquence mais déphasés de 90 degrés. Cette méthode est appelée modulation d'amplitude en quadrature (QAM).

L'équation de la modulation DSSC est  $y(t)=d \cdot m(t) \cdot \sin(\omega_c t)$

En modulation DSB-SC, le signal porteur est inversé chaque fois que  $m(t) < 0$ . Pour la modulation QAM, le deuxième signal porteur serait  $\cos(\omega_c t)$ , d'où un déphasage de 90 degrés par rapport au premier signal porteur.

### Modulation de fréquence (FM)

La modulation de fréquence fait varier la fréquence d'un signal porteur en fonction du signal modulant :

$$y(t)=A_c \cdot \sin[(\omega_c+d \cdot m(t)) \cdot t]$$

où  $m(t)$  correspond au signal modulant et  $d$  à la variation de fréquence. La modulation FM est à bande étroite si la variation est inférieure à 1 % de la bande passante du signal modulant (large bande autrement). Vous pouvez obtenir une approximation de la bande passante du signal modulé avec les équations suivantes.

$BW \approx 2 \cdot$  (Bande passante du signal modulant) pour une FM à bande étroite

$BW \approx 2 \cdot$  (Variation + Bande passante du signal modulant) pour une FM à bande étroite

La trace supérieure représente le signal modulant, alors que la trace inférieure représente le signal porteur modulé.

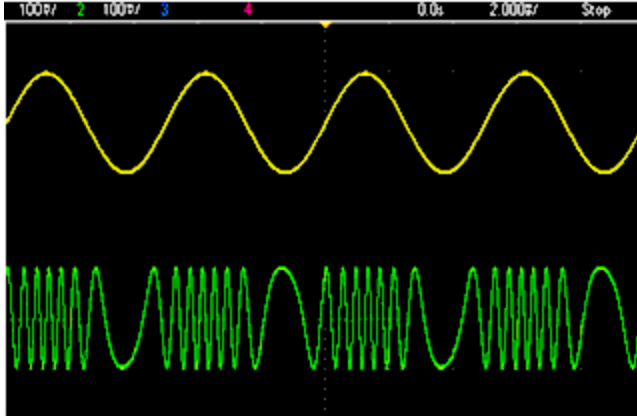

### Modulation de phase (PM)

La modulation de phase (PM) est similaire à la modulation FM, mais la phase du signal porteur varie à la place de la fréquence :

$$y(t)=\sin[\omega_c t+d \cdot m(t)]$$

où  $m(t)$  correspond au signal modulant et  $d$  à la variation de phase.

### Modulation par déplacement de fréquence (FSK)

La modulation par déplacement de fréquence (FSK) est similaire à la modulation de fréquence (FM), à la différence près que la fréquence du signal porteur alterne entre deux valeurs prédéfinies : la fréquence du signal porteur et la fréquence de saut. Parfois, les fréquences de saut et du signal porteur sont respectivement appelées « Marque » et « Espace ». La vitesse de commutation entre ces valeurs est déterminée par une horloge interne ou le signal sur le connecteur **Ext Trig** de la face arrière. Les variations de fréquence sont instantanées et à phase continue.

Le signal modulant interne est un signal carré présentant un rapport cyclique de 50 %.

La trace supérieure représente le signal modulant, alors que la trace inférieure représente le signal porteur modulé.

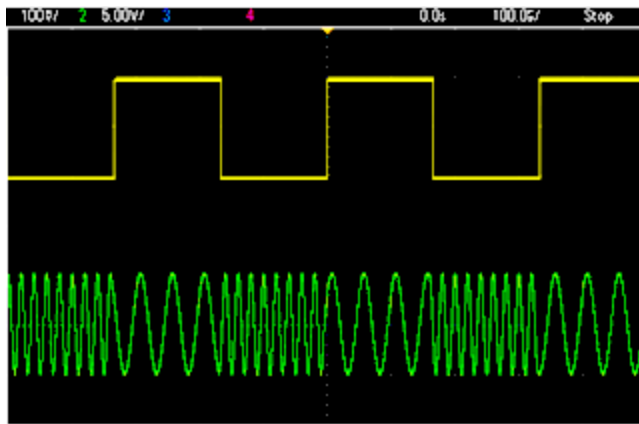

### Modulation par déplacement de fréquence binaire (BPSK)

La modulation BPSK est similaire à la modulation FSK. Toutefois, dans ce type de modulation, c'est la phase du signal porteur, plutôt que sa fréquence, qui alterne entre deux valeurs. La vitesse de commutation entre ces valeurs est déterminée par une horloge interne ou le signal sur le connecteur **Ext Trig** de la face arrière. Les variations de phase sont instantanées.

Le signal modulant interne est un signal carré présentant un rapport cyclique de 50 %.

### Modulation de largeur d'impulsion (PWM)

La modulation PWM est disponible uniquement pour un train d'impulsions ; la largeur d'impulsion varie en fonction du signal modulant. L'importance de variation d'une largeur d'impulsion est appelée variation de largeur ; elle peut être spécifiée en pourcentage de la période du signal (rapport cyclique) ou en unité de temps. Par exemple, si vous spécifiez une impulsion avec un rapport cyclique de 20 % et activez ensuite la modulation PWM avec une variation de 5 %, le rapport cyclique varie entre 15 % et 25 % sous le contrôle du signal modulant.

**Modulation additive (somme)**

La fonction « Sum » ajoute le signal modulant au signal porteur. Par exemple, vous pouvez ajouter à un signal des quantités contrôlées de bruit à bande passante variable ou créer des signaux à deux fréquences porteuses. Le générateur interne de modulation de l'instrument peut produire le même signal continu que le générateur principal ; la fonction Sum permet de créer de nombreux signaux qui auraient nécessité deux instruments auparavant.

La fonction Sum augmente l'amplitude du signal de sortie de l'amplitude du signal modulant. Cela peut entraîner le basculement de l'instrument vers une plage de tension supérieure en sortie qui provoque une perte momentanée de signal. Si cela pose un problème dans votre application, activez la fonction Range Hold. Si une augmentation de tension peut endommager votre dispositif testé, appliquez des limites de tension.



## Rafale

Vous pouvez configurer l'instrument afin d'émettre un signal sur un nombre déterminé de cycles, appelé rafale. Vous pouvez utiliser les rafales dans l'un des deux modes suivants : rafales à N-cycles (également appelées « rafales déclenchées ») ou rafales commandées.

Une rafale à N cycles est constituée d'un nombre donné de cycles de signaux (de 1 à 1 000 000). Elle est toujours provoquée par un événement de déclenchement. Vous pouvez également définir le nombre de cycles de rafale sur « Infinite », ce qui génère un signal continu lorsque l'instrument est déclenché.

Dans l'image ci-dessous, la trace supérieure représente la sortie de synchronisation et la trace inférieure, la sortie principale.

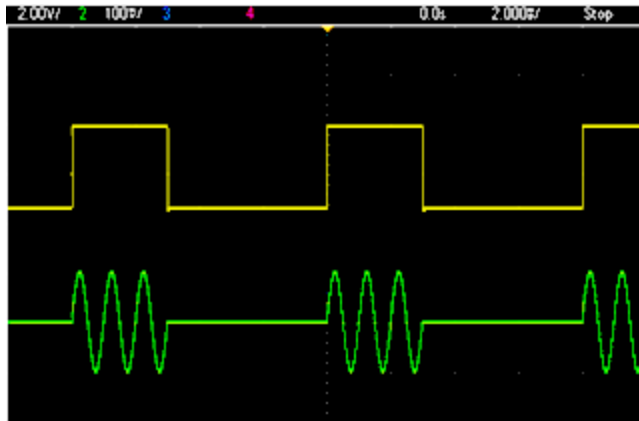

### Signal en rafale de trois cycles

Pour les rafales, la source de déclenchement peut être un signal externe, une horloge interne, une touche ou une commande émise sur l'interface distante. L'entrée des signaux externes de déclenchement est le connecteur **Ext Trig** de la face arrière. Ce connecteur est relié à la masse du châssis (et non une masse flottante). Lorsqu'il n'est pas utilisé comme entrée, le connecteur **Ext Trig** peut être configuré comme sortie afin de permettre à l'instrument de déclencher d'autres instruments en même temps que son déclenchement interne.

Une rafale à N cycles commence et finit toujours au même point du signal, appelé phase initiale.

En mode de rafale commandée (GATed), le signal de sortie est actif ou inactif en fonction du signal sur le connecteur **Ext Trig** de la face arrière. Sélectionnez la polarité de ce signal à l'aide de la commande **BURSt:GATE:POLarity**. Lorsque le signal de commande est vrai, l'instrument envoie un signal continu. Si le signal de commande est faux, le cycle en cours se termine, puis l'instrument s'arrête et sa tension demeure au niveau correspondant à la phase de rafale initiale du signal. Pour un signal de bruit, la sortie s'arrête immédiatement lorsque le signal de commande devient faux.

## Balayage en fréquence

Le balayage en fréquence est similaire à la modulation de fréquence (FM), mais n'utilise pas de signal modulant. À la place, l'instrument règle la fréquence de sortie d'après une fonction linéaire ou logarithmique ou une liste de 128 fréquences (max.) spécifiées par l'utilisateur. Un balayage linéaire change la fréquence de sortie d'une valeur constante en Hz, alors qu'un balayage logarithmique change la fréquence d'une valeur constante de décades par seconde. Les balayages logarithmiques permettent de couvrir les plages de fréquence étendues où la résolution aux basses fréquences serait potentiellement perdue dans un balayage linéaire.

Les balayages en fréquence sont caractérisés par un temps de balayage (pendant lequel la fréquence change régulièrement de la fréquence initiale à la fréquence finale), un temps de maintien (pendant lequel la fréquence reste à la fréquence finale) et un temps de retour (pendant lequel la fréquence revient de façon régulière et linéaire à la fréquence initiale). Les paramètres de déclenchement déterminent à quel moment le balayage suivant commence.

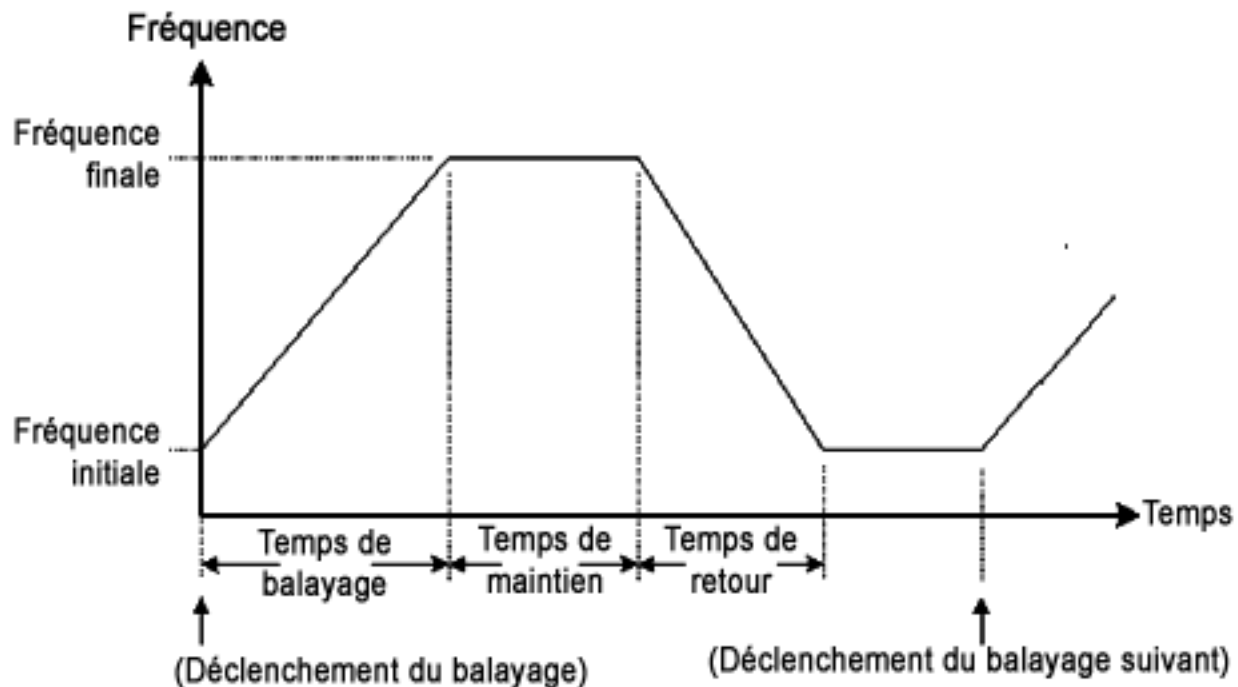

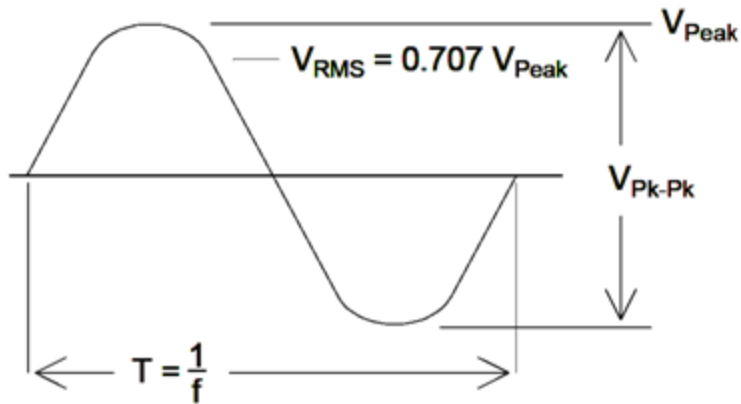

## Attributs des signaux CA

Le signal CA le plus courant est sinusoïdal. En effet, tout signal périodique correspond à la somme de différentes ondes sinusoïdales. En général, l'amplitude d'une onde sinusoïdale est donnée par sa valeur crête, crête à crête ou de moyenne quadratique (RMS ou efficace). Toutes ces mesures supposent que le signal ait un décalage de tension nul.

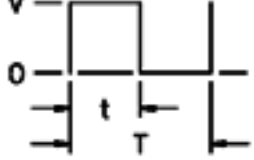

La tension de crête d'un signal est la valeur absolue maximale de tous ses points. La tension crête à crête est la différence entre le maximum et le minimum. La tension efficace est égale à l'écart-type de tous les points du signal ; elle représente également la puissance moyenne dans un cycle du signal diminuée de la puissance de n'importe quelle composante CC du signal. Le facteur de crête est égal à la valeur crête d'un signal divisée par sa valeur efficace. Il varie selon le signal. Le tableau ci-dessous présente plusieurs signaux courants avec les facteurs de crête et les valeurs efficaces respectifs.

Forme du signal	Facteur de crête (C.F.)	Val. eff. (CA)	AC+DC RMS
	1.414	$\frac{V}{1.414}$	$\frac{V}{1.414}$
	1.732	$\frac{V}{1.732}$	$\frac{V}{1.732}$
	$\sqrt{\frac{T}{t}}$	$\frac{V}{C.F.} \times \sqrt{1 - \left(\frac{1}{C.F.}\right)^2}$	$\frac{V}{C.F.}$

Si un voltmètre à lecture de valeur moyenne est utilisé pour mesurer la « composante continue » d'un signal, la lecture peut ne pas être conforme au réglage de la tension résiduelle CC. Ce risque existe parce que le signal peut avoir une valeur moyenne non nulle qui s'ajouterait à la tension continue de décalage.

Vous pouvez rencontrer des niveaux CA exprimés en « décibels par rapport à 1 milliwatt » (dBm). Étant donné que le gain dBm représente un niveau de puissance, vous devez connaître la tension efficace (RMS) du signal et la résistance de charge pour effectuer le calcul.

$$\text{dBm} = 10 \times \log_{10} (P / 0.001) \text{ où } P = V_{\text{RMS}}^2 / R_L$$

Pour une onde sinusoïdale dans une charge de 50 Ω, le tableau ci-dessous indique la tension en fonction du gain dBm.

<b>dBm</b>	<b>Tension efficace (RMS)</b>	<b>Tension crête à crête</b>
+23,98 dBm	3,54 Veff	10,00 Vpp
+13,01 dBm	1,00 Veff	2,828 Vpp
+10,00 dBm	707 mVeff	2,000 Vpp
+6,99 dBm	500 mVeff	1,414 Vpp
3,98 dBm	354 mVeff	1,000 Vpp
0,00 dBm	224 mVeff	632 mVpp
-6,99 dBm	100 mVeff	283 mVpp
-10,00 dBm	70,7 mVeff	200 mVpp
-16,02 dBm	35,4 mVeff	100 mVpp
-30,00 dBm	7,07 mVeff	20,0 mVpp
-36,02 dBm	3,54 mVeff	10,0 mVpp
-50,00 dBm	0,707 mVeff	2,00 mVpp
-56,02 dBm	0,354 mVeff	1,00 mVpp

Pour des charges de 75 Ω ou 600 Ω, utilisez les conversions suivantes.

$$\text{dBm (75 } \Omega) = \text{dBm (50 } \Omega) - 1,76$$

$$\text{dBm (600 } \Omega) = \text{dBm (50 } \Omega) - 10,79$$

## Imperfections des signaux

Pour les signaux sinusoïdaux, les imperfections courantes sont plus faciles à décrire et à observer dans le domaine des fréquences à l'aide d'un analyseur de spectre. Toute composante d'un signal de sortie ayant une fréquence différente de la fondamentale (ou « porteuse ») est considérée comme une distorsion. Ces imperfections peuvent se classer en distorsion harmonique, parasites non harmoniques ou en bruit de phase ; elles sont exprimées en décibels par rapport au niveau de la porteuse ou « dBc ».

### Distorsion harmonique

Les composantes harmoniques se produisent à des fréquences multiples de la fréquence fondamentale et sont généralement créées par des composantes non linéaires dans la propagation du signal. Aux faibles amplitudes du signal, une autre source possible de distorsion harmonique est le signal **Sync** qui est un signal carré avec de nombreuses composantes harmoniques fortes qui peuvent s'introduire dans le signal principal. Bien que le signal **Sync** soit fortement isolé des sorties du signal principal de l'instrument, le couplage peut se produire dans le câblage externe. Pour de meilleurs résultats, utilisez des câbles coaxiaux avec double ou triple blindage. Si le signal **Sync** n'est pas indispensable, ne le connectez pas ou ne l'activez pas.

### Parasites non harmoniques

Une source de parasites non harmoniques est le convertisseur numérique/analogique (DAC) qui convertit le signal numérique en tension. La non-linéarité de ce convertisseur produit des harmoniques qui peuvent être supérieures à la fréquence de Nyquist et sont donc repliées à une fréquence inférieure. Par exemple, la cinquième harmonique de 30 MHz (150 MHz) peut créer un parasite à 100 MHz.

Le couplage de sources de signaux sans rapport (horloge système, par exemple) avec le signal de sortie est une autre source de parasites non harmoniques. Ces parasites ont en général une amplitude constante et sont plus perturbants avec des amplitudes du signal inférieures à 100 mVpp. Pour une pureté de signal optimale à faible amplitude, conservez un niveau relativement élevé de la sortie de l'instrument et utilisez un atténuateur externe.

### Bruit de phase

Le bruit de phase est provoqué par de légères variations instantanées de la fréquence de sortie (« gigue »). Sur un analyseur de spectre, il apparaît comme une augmentation du bruit de fond apparent à proximité de la fréquence du signal de sortie. Le bruit de phase représente les amplitudes du bruit dans les bandes 1 Hz séparées de 1 kHz, 10 kHz et 100 kHz d'un signal sinusoïdal de 30 MHz. N'oubliez pas que les analyseurs de spectre comportent également du bruit de phase ; les niveaux que vous lisez peuvent comporter du bruit de phase des analyseurs.

**Bruit de quantification**

La résolution finie dans le convertisseur numérique/analogique du signal provoque des erreurs de quantification. En supposant que les erreurs sont uniformément réparties sur une plage de  $\pm 0,5$  fois le bit de poids faible, le niveau de bruit de signaux standard est environ égal à  $-95$  dBc. À ce niveau, les autres sources de bruit dans l'instrument sont dominantes. Cependant, le bruit de quantification peut poser un problème dans les signaux arbitraires qui n'utilisent pas la plage complète des codes du convertisseur numérique/analogique ( $-32\,767$  à  $+32\,767$ ). Dans la mesure du possible, mettez à l'échelle les signaux arbitraires pour utiliser la plage complète.

## Boucles de masse

La partie générant le signal de l'instrument est isolée de la masse du châssis (terre). Cette isolation élimine les boucles de masse dans le système et permet de référencer le signal émis par rapport à d'autres tensions que la masse. La figure ci-dessous illustre l'instrument connecté à une charge via un câble coaxial. Toute différence de potentiel de masse ( $V_{GND}$ ) tend à faire circuler le courant  $I_{GND}$  dans le blindage du câble, provoquant ainsi une chute de tension due à l'impédance du blindage ( $Z_{SHIELD}$ ). Cette tension ( $I_{GND} \times Z_{SHIELD}$ ) apparaît comme une erreur dans la tension de la charge. Toutefois, si l'instrument est isolé, une impédance série élevée (généralement,  $>1 \text{ M}\Omega$  en parallèle avec  $50 \text{ nF}$ ) apparaît dans la propagation en opposition au passage de  $I_{GND}$  et minimise donc cet effet.

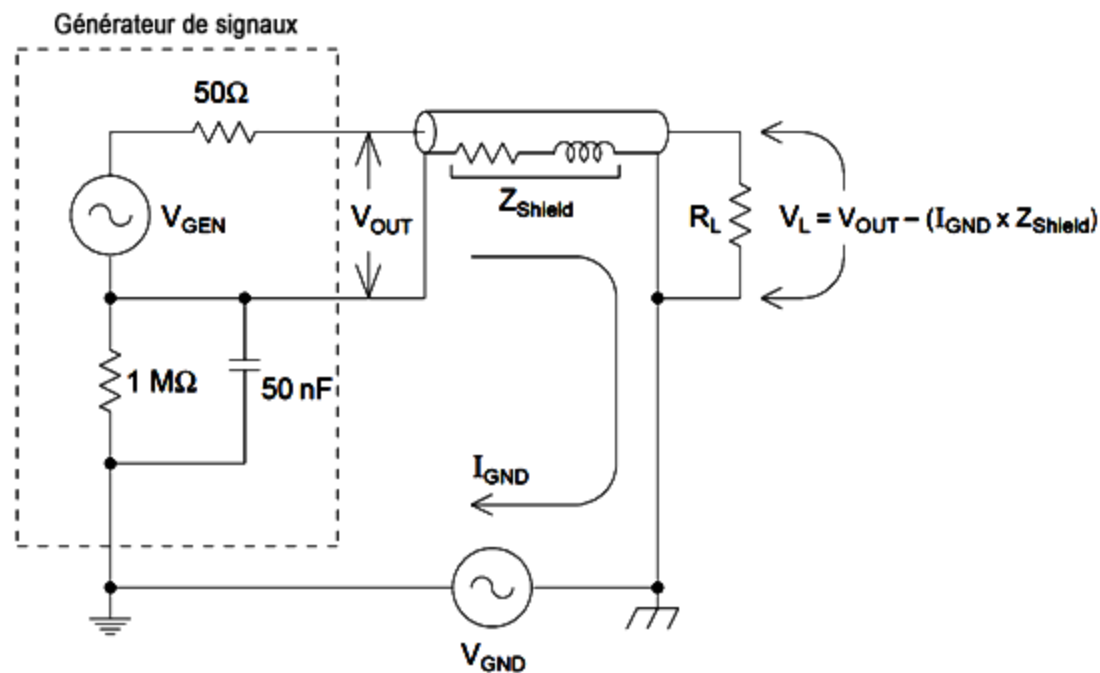

Aux fréquences supérieures à quelques kHz, le blindage d'un câble coaxial devient inductif, et non résistif, de sorte que le câble se comporte comme un transformateur. Dans ce cas, la tension chute dans le blindage du fait que  $I_{GND}$  tend à se décaler de tensions égales dans le conducteur central, ce qui diminue les effets des boucles de masse aux hautes fréquences. Les câbles coaxiaux constitués de deux ou trois blindages tressés sont beaucoup plus adaptés que ceux à blindages simples ou en feuilles, car leur résistance est inférieure et ils deviennent par conséquent des transformateurs à basse fréquence.

Pour réduire les erreurs dues aux boucles de masse, connectez l'instrument à la charge via un câble coaxial de qualité supérieure et reliez-le à la masse au niveau de la charge à l'aide du blindage. Si possible, branchez l'instrument et la charge sur la même prise électrique pour minimiser les différences de potentiel de masse.

Rappelez-vous que les boîtiers extérieurs des connecteurs **Sync** et **Modulation In** sont connectés à ceux des connecteurs de la sortie principale. Les câbles raccordés aux connecteurs **Sync** et/ou **Modulation In** sont donc des sources potentielles de boucles de masse. Notez également que toute tentative d'application de tensions différentes à ces boîtiers peut entraîner le passage d'un courant fort dans l'instrument et éventuellement endommager ce dernier.

# Référence de programmation SCPI

Cette rubrique décrit le langage de programmation SCPI de l'instrument.

[Présentation du langage SCPI](#)

[Signaux des fonctions internes](#)

[Liste alphabétique des commandes et des requêtes SCPI](#)

[Exemples de programmation](#)

[Aide-mémoire des commandes](#)

[Réinitialisation de la configuration d'usine](#)

[Messages d'erreur SCPI](#)

## Présentation du langage SCPI

SCPI (Standard Commands for Programmable Instruments) est un langage ASCII de commande conçu pour les instruments de test et de mesure. Les commandes SCPI sont basées sur une structure hiérarchique appelée *système arborescent*. Dans ce système, les commandes associées sont regroupées dans un nœud (ou racine) commun pour former un *sous-système*. Une partie du sous-système OUTPUT est représentée ci-dessous pour illustrer l'arborescence.

OUTPUT:

    SYNC {OFF|0|ON|1}

        SYNC:

            MODE {NORMal|CARRier}

            POLarity {NORMal|INVerted}

**OUTPUT** est le mot clé racine, **SYNC** est un mot clé secondaire ; **MODE** et **POLarity** sont des mots clés tertiaires. Le signe ( : ) sépare un mot clé d'un mot clé de niveau inférieur.

## Conventions syntaxiques

Le format des commandes est indiqué ci-dessous :

[SOURce[1|2]:]VOLTage:UNIT {VPP|VRMS|DBM}

[SOURce[1|2]:]FREQuency:CENTer { < fréquence > |MINimum|MAXimum|DEFault}

Cette syntaxe illustre la plupart des commandes (et certains paramètres) comportant des lettres majuscules et minuscules. Les majuscules indiquent l'abréviation des commandes. Pour réduire la taille des lignes de programme, vous pouvez utiliser la forme abrégée. Pour une meilleure lisibilité des programmes, vous pouvez utiliser la forme longue.

Par exemple, dans l'instruction ci-dessus, VOLT et VOLTAGE sont deux formes acceptables. Vous pouvez utiliser des majuscules ou des minuscules. Par conséquent, les formes VOLTAGE, volt et Volt sont toutes acceptables. Les autres formes (par ex., VOL et VOLTAG) ne sont pas acceptables et génèrent une erreur.



## Référence de programmation SCPI

- Les accolades ( { } ) entourent les paramètres d'une commande donnée. Elles ne sont pas envoyées avec la chaîne de commande.
- Une barre verticale ( | ) sépare plusieurs paramètres dans une chaîne de commande donnée. Par exemple, {VPP|VRMS|DBM} dans la commande ci-dessus indique que vous pouvez spécifier « VPP », « VRMS » ou « DBM ». La barre n'est pas envoyée avec la chaîne de commande.
- Les signes « inférieur » et « supérieur » ( < > ) indiquent que vous devez spécifier une valeur pour le paramètre entouré. Par exemple, l'instruction suivante présente le paramètre < fréquence > entre les signes < et >. Ces marqueurs ne sont pas envoyés avec la chaîne de commande. Vous devez spécifier une valeur pour le paramètre (par ex., « FREQ:CENT 1000 »), sauf si vous sélectionnez une autre option indiquée dans la syntaxe (par ex., « FREQ:CENT MIN »).
- Certains éléments de syntaxe (par ex., nœuds et paramètres) figurent entre crochets ( [ ] ). Cela indique que cet élément est facultatif. Les crochets ne sont pas envoyés avec la chaîne de commande. Si vous ne spécifiez pas de valeur pour un paramètre facultatif, l'instrument choisit la valeur par défaut. Dans les exemples ci-dessus, « SOURce[1|2] » indique que vous pouvez faire référence à la voie source 1 par « SOURce » ou « SOURce1 » ou « SOUR1 » ou « SOUR ». De plus, comme le nœud SOURce est facultatif (entre crochets), vous pouvez également faire référence à la voie 1 en omettant le nœud SOURce, car la Voie 1 est la voie par défaut du nœud de langage SOURce. En revanche, pour faire référence à la Voie 2, vous devez utiliser « SOURce2 » ou « SOUR2 » dans les lignes de programme.

## Séparateurs de commandes

Le signe ( : ) sépare un mot clé d'un mot clé de niveau inférieur. Vous devez insérer un espace pour séparer un paramètre d'un mot clé de commande. Si une commande nécessite plusieurs paramètres, vous devez les séparer par une virgule, comme illustré ci-dessous :

```
APPL:SIN 455E3,1.15,0.0
```

Dans cet exemple, la commande APPLy spécifie un signal sinusoïdal de fréquence 455 KHz d'une amplitude 1,15 volts avec une tension résiduelle CC de 0,0 volt.

Le point-virgule ( ; ) sépare les commandes dans un sous-système et minimise la frappe. Par exemple, la chaîne de commande :

```
TRIG:SOUR EXT; COUNT 10
```

est identique aux deux commandes suivantes :

```
TRIG:SOUR EXT  
TRIG:COUNT 10
```

## Utilisation des paramètres MIN, MAX et DEF

Pour de nombreuses commandes, vous pouvez remplacer un paramètre par « MIN » ou « MAX » et par « DEF » dans certains cas. Par exemple, examinons la chaîne de commande :

```
[SOURce[1|2]:]APPLy:DC [{<fréquence>|DEF}[, {<amplitude>|DEF}[, {<tension
résiduelle>|MIN|MAX|DEF}]]]
```

À la place d'une valeur donnée pour le paramètre *<tension résiduelle>*, vous pouvez utiliser MIN pour définir la tension résiduelle à sa valeur minimale et MAX pour la définir à sa valeur maximale. Vous pouvez également spécifier DEF pour configurer la valeur par défaut de chaque paramètre : *<fréquence>*, *<amplitude>* et *<tension résiduelle>*.

## Requêtes sur les paramètres

Vous pouvez rechercher la valeur actuelle de la plupart des paramètres en ajoutant le point d'interrogation ( ? ) à la commande. Par exemple, la commande suivante configure le nombre de déclenchements avec 10 lectures :

```
TRIG:COUN 10
```

Vous pouvez ensuite rechercher le nombre avec la commande :

```
TRIG:COUN?
```

Vous pouvez également rechercher le nombre minimal et maximal autorisé :

```
TRIG:COUN? MIN
TRIG:COUN? MAX
```

## Caractères de fin de commande SCPI

Une chaîne de commande envoyée à l'instrument doit se terminer par un caractère de *<nouvelle ligne>* (*<NL>*). Le message IEEE-488 EOI (End-Or-Identify) est interprété comme le caractère *<NL>* et peut être utilisé pour terminer une commande à la place du caractère *<NL>*. Le *<retour chariot>* suivi d'un caractère *<NL>* est également accepté. Le caractère de fin de commande réinitialise toujours le chemin de la commande SCPI au niveau racine.

### REMARQUE

Pour chaque message SCPI comportant une requête et envoyé à l'instrument, l'instrument termine la réponse renvoyée par un caractère *<NL>* ou un caractère de fin de ligne (EOI). Par exemple, si « DISP:TEXT? » est envoyé, la réponse se termine par *<NL>* après la chaîne de données qui est renvoyée. Si un message SCPI comporte plusieurs requêtes séparées par des points virgules (par ex., « DISP?;DISP:TEXT? »), la réponse renvoyée se termine à nouveau par le caractère *<NL>* après la réponse à la dernière requête. Dans tous les cas, le programme doit lire ce caractère *<NL>* dans la réponse avant d'envoyer une autre commande à l'instrument, faute de quoi une erreur se produit.

## Commandes courantes IEEE-488.2

La norme IEEE-488.2 définit un ensemble de commandes qui exécutent des fonctions telles que la réinitialisation, les autotests et l'état de l'instrument. Les commandes courantes commencent toujours par un

## Référence de programmation SCPI

astérisque (\*), comportent 3 caractères et peuvent inclure un ou plusieurs paramètres. Le mot clé d'une commande est séparé du premier paramètre par un espace. Utilisez un point-virgule (;) pour séparer plusieurs commandes, comme illustré ci-dessous :

```
*RST; *CLS; *ESE 32;*OPC?
```

## Types de paramètres SCPI

Le langage SCPI définit plusieurs formats de données à utiliser dans les messages des programmes et des réponses.

### Paramètres numériques

Les commandes qui nécessitent des paramètres numériques acceptent toutes les notations décimales courantes des nombres, y compris les signes facultatifs, les points décimaux et la notation scientifique. Les valeurs spéciales des paramètres numériques, telles que MIN, MAX et DEF sont également acceptées. Vous pouvez également envoyer des suffixes d'unités techniques (par ex., M, k, m ou u). Si une commande accepte uniquement certaines valeurs données, l'instrument arrondit automatiquement les paramètres numériques d'entrée avec les valeurs acceptées. La commande suivante nécessite un paramètre numérique pour la fréquence :

```
[SOURce[1|2]:]FREQuency:CENTer {<fréquence>|MINimum|MAXimum}
```

#### REMARQUE

Du fait que l'interpréteur SCPI distingue les majuscules et les minuscules, il existe une confusion sur la lettre « M » (ou « m »). Par commodité, l'appareil interprète « mV » (ou « MV ») comme des millivolts, mais « MHZ » (ou « mhz ») comme des mégahertz. De même, « MΩ » (ou « mΩ ») est interprété comme des mégohms. Vous pouvez utiliser le préfixe « MA » pour méga. Par exemple, « MAV » est interprété comme des mégavolts.

### Paramètres discrets

Les paramètres discrets sont utilisés pour programmer des paramètres ayant un nombre limité de valeurs (par ex., IMMEDIATE, EXTERNAL ou BUS). Ils peuvent avoir une forme abrégée et une forme longue, tout comme les mots clés des commandes. Vous pouvez combiner des majuscules et des minuscules. Les réponses aux requêtes retournent toujours la forme abrégée en majuscules. La commande suivante nécessite un paramètre discret pour l'unité de tension :

```
[SOURce[1|2]:]VOLTage:UNIT {VPP|VRMS|DBM}
```

### Paramètres booléens

Les paramètres booléens représentent une condition binaire exclusivement vraie ou fausse. Pour une condition fausse, l'instrument accepte « OFF » ou « 0 ». Pour une condition vraie, l'instrument accepte « ON » ou « 1 ». Lorsque vous effectuez une requête sur un paramètre booléen, l'instrument renvoie toujours la valeur « 0 » ou « 1 ». La commande suivante nécessite un paramètre booléen :

```
DISPlay {OFF|0|ON|1}
```

## Paramètres de chaînes de caractères ASCII

Les paramètres de chaînes de caractères peuvent pratiquement contenir n'importe quelle combinaison de paramètres ASCII. Une chaîne de caractères doit commencer et se terminer par des guillemets simples ou doubles. Vous pouvez inclure le délimiteur de guillemets dans la chaîne de caractères en le tapant deux fois sans caractères entre eux. La commande suivante utilise un paramètre de chaîne de caractères :

```
DISPlay:TEXT <quoted string>
```

Par exemple, la commande suivante affiche le message « WAITING... » sur la face avant de l'instrument (les guillemets ne sont pas affichés).

```
DISP:TEXT "WAITING..."
```

Vous pouvez également afficher le même message avec des guillemets simples.

```
DISP:TEXT 'WAITING...'
```

## Utilisation du message Device Clear

Device Clear est un message de bas niveau du bus IEEE-488 que vous pouvez utiliser pour ramener l'instrument dans l'état réactif. Différents langages de programmation et des cartes d'interface IEEE-488 permettent d'accéder à cette fonction au moyen de commandes propres. Les registres d'état, la file d'erreurs et tous les états de configuration ne sont pas modifiés à la réception d'un message Device Clear.

Device Clear effectue les actions suivantes :

- Si une mesure est en cours, elle est annulée.
- L'instrument retourne à l'état d'attente de déclenchement.
- Les mémoires tampon d'entrée et de sortie de l'instrument sont effacées.
- L'instrument est prêt à recevoir une nouvelle chaîne de commande.

**REMARQUE** La commande **ABORt** est la méthode recommandée pour terminer une opération de l'instrument.

## Signaux de fonctions internes

Les signaux de fonctions internes sont présentés ci-dessous.

- **SINusoid** : signal sinusoïdal sans déphasage.

## Référence de programmation SCPI

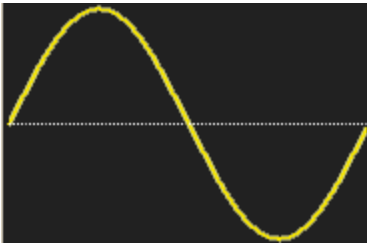

- **SQUare** : signal carré, rapport cyclique de 50 %.



- **RAMP** : rampe, symétrie de 100 %.

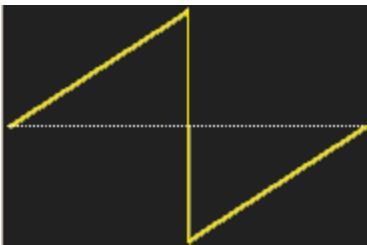

- **NRAMP** : rampe négative, symétrie de 0 %.



- **TRiangle** : rampe, symétrie de 50 %.

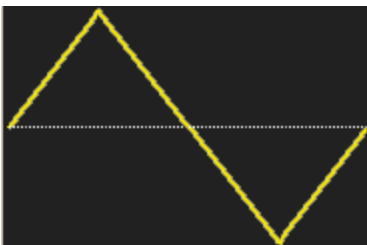

- **NOISe** : bruit gaussien ; si NOISe est la fonction interne, il ne peut pas être également le signal porteur.

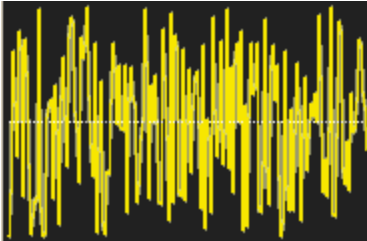

- **PRBS** : modulation de séquence binaire pseudo-aléatoire (PRBS) ; si PRBS est la fonction interne, elle ne peut pas être également le signal porteur.

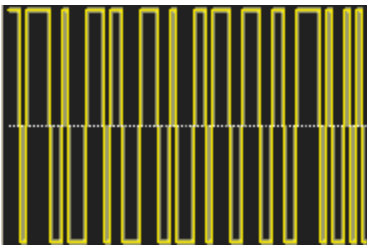

- **ARBitrary** : signal arbitraire ; croissance exponentielle par défaut ; si ARB est la fonction interne, elle ne peut pas être également le signal porteur.

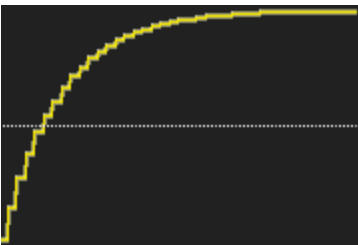

Voir également

[Sous-système AM](#)

[Sous-système FM](#)

[Sous-système PM](#)

[Sous-système PWM](#)

[Sous-système SUM](#)

Liste alphabétique des commandes et des requêtes SCPI

**ABORt**

[Sous-système AM](#)

[Sous-système APPLy](#)

[Sous-système BPSK](#)

[Sous-système BURSt](#)

## Référence de programmation SCPI

Sous-système CALibration

COMBine:FEED

Sous-système DATA

Sous-système DISPlay

Sous-système FM

FORMat:BORDER

Sous-système FREQuency

Sous-système FSKey

Sous-système FUNCTion

Sous-système HCOPY

Commandes courantes IEEE-488.2

Sous-système INITiate

INPut\_ATTenuation\_STATE

Sous-système LIST

Sous-système LXI

Sous-système MARKer

Sous-système MEMory

Sous-système MMEMory

Sous-système OUTPut

Sous-système PHASE

Sous-système PM

Sous-système PWM

Sous-système RATE

Sous-système ROSC

Sous-système SOURce

Sous-système STATus

Sous-système SUM

Sous-système SWEEp

Sous-système SYSTem

SYSTem: LAN Configuration

TRACK

Sous-système TRIGger

UNIT:ANGLE

UNIT:ARBITrary:ANGLE

Sous-système VOLTage

## ABORt

Interrompt une séquence, une liste, un balayage ou une rafale, même infinis. Provoque également le retour du sous-système de déclenchement à l'état de veille. Si l'option **INITiate:CONTinuous** est activée (ON), l'instrument passe immédiatement à l'état l'attente d'un déclenchement.

Paramètre	Renvoi type
(aucun)	(aucun)
Interrompt les éléments ci-dessus : ABORt	

- Interrompt toute action déclenchée (liste, balayage, rafale, lecture de signal arbitraire déclenché).
- La commande ABORt n'a pas d'effet lorsque l'instrument est en mode normal ou modulé, sauf pour les séquences de signaux arbitraires, les listes, les rafales et les balayages. Si l'instrument exécute une séquence, une liste, une rafale ou un balayage, la commande ABORt redémarre l'élément interrompu avec la commande **INIT** et les conditions de déclenchement actuelles.
- Lorsque la commande ABORt est en mode liste, la fréquence revient à la fréquence du mode « normal » jusqu'à ce que le premier déclenchement se produise. Après le premier déclenchement, la première fréquence de la liste est utilisée.
- Si la commande ABORt est exécutée pendant un balayage, le balayage revient à la fréquence de balayage initiale.
- La commande ABORt s'applique aux deux voies d'un instrument 2 voies.

## Sous-système AM

Le sous-système AM permet d'ajouter la modulation d'amplitude (AM) à un signal porteur.

### Exemple

Pour générer un signal à modulation d'amplitude (AM) :

1. **Configurez le signal porteur** : Utilisez les commandes **FUNCtion**, **FREQuency**, **VOLTage** et **VOLTage:OFFSet** pour spécifier la fonction du signal, sa fréquence, son amplitude et sa tension résiduelle.
2. **Sélectionnez le mode de modulation d'amplitude** : **AM:DSSC**
3. **Sélectionnez la source de modulation (interne, externe, CH1 ou CH2)** : **AM:SOURce**. Pour une source externe, vous pouvez ignorer les opérations 4 et 5 ci-dessous.
4. **Sélectionnez le signal modulant** : **AM:INTernal:FUNCtion**
5. **Définissez la fréquence de modulation** : **AM:INTernal:FREQuency**
6. **Définissez la profondeur de modulation** : **AM[:DEPT]h**
7. **Activez la modulation d'amplitude (AM)** : **AM:STATe:ON**

Le code suivant produit l'image d'oscilloscope illustrée ci-dessous.



```

FUNction SQU
FREQuency +1,0E+04
VOLtagE +1
VOLtagE:OFFset 0,0
AM:SOURce INT
AM:DSSC 0
AM:DEPT h +120
AM:INTernal:FUNCTion TRI
AM:INTernal:FREQ 5E+02
AM:STATe 1
OUTPut1 1

```

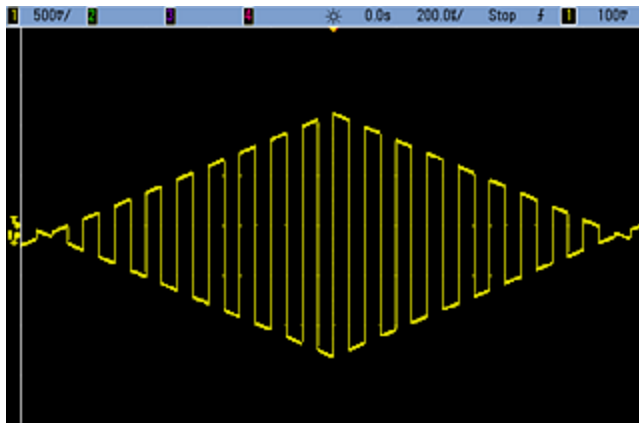

**[SOURCE[1|2]:]AM[:DEPT h] {<profondeur\_en\_pourcentage>|MINimum|MAXimum}**  
**[SOURCE[1|2]:]AM[:DEPT h]? [{MINimum|MAXimum}]**

Définit la profondeur de modulation interne (« taux de modulation ») en pourcentage.

Paramètre	Renvoi type
0 à 120, 100 par défaut	+5,0000000000000000E+01
Définissez la profondeur de modulation interne à 50 % : AM:DEPT 50	
Définissez la profondeur de modulation interne à 120 % : AM:DEPT MAX	

- Même à une profondeur supérieure à 100 %, l'instrument ne dépasse pas  $\pm 5$  V en crête sur la sortie (dans une charge de 50  $\Omega$ ). Pour obtenir une profondeur de modulation supérieure à 100 %, l'amplitude du signal porteur peut être réduite.
- Avec AM:SOURce EXTERNAL, un signal externe module le signal porteur. La profondeur de modulation est contrôlée par le niveau de signal  $\pm 5$  V (ou le niveau de signal  $\pm 1$  V en option sur la série 33600) sur le connecteur **Modulation In** de la face arrière. Par exemple, si la profondeur de modulation (AM[:DEPT h]) est de 100 %, lorsque le signal modulant est à +5 V (ou éventuellement de +1 V sur la série 33600), l'amplitude de la sortie est maximale. De même, un signal modulant de -5 V (ou éventuellement de -1 V sur la série 33600) génère une amplitude de sortie minimale.

## Voir également

**INPut:ATTenuation[:STATe]**

**[SOURce[1|2]:]AM:DSSC {ON|1|OFF|0}**

**[SOURce[1|2]:]AM:DSSC?**

Sélectionne le mode de modulation d'amplitude – Double Sideband Suppressed Carrier (ON) ou signal porteur modulé en amplitude (AM) avec bandes latérales (OFF).

Paramètre	Renvoi type
{ON 1 OFF 0}	0 (OFF) ou 1 (ON)
Définissez la modulation AM en mode DSSC : AM:DSSC ON	

- La valeur par défaut à la mise sous tension est OFF.
- En mode AM DSSC, la modulation nulle provoque un signal de sortie nul ; l'augmentation du signal d'entrée de modulation augmente l'amplitude des bandes latérales proportionnellement à l'amplitude du signal modulant.
- La modulation AM DSSC est utile pour certains modes numériques de modulation.
- En modulation AM « normale », la modulation nulle provoque la sortie d'un signal porteur de demi-amplitude. Lorsque le signal d'entrée de la modulation augmente, le signal porteur est modulé en amplitude entre 0 et 100 % de l'amplitude.
- En mode DSSC, le paramètre **AM[:DEPTh]** s'applique et met à l'échelle le signal de modulation de 0 à 120 % de la modulation.

[SOURce[1|2]:]AM:INTernal:FREQUency {<fréquence>|MINimum|MAXimum|DEFault}  
[SOURce[1|2]:]AM:INTernal:FREQUency? [{MINimum|MAXimum}]

Définit la fréquence du signal modulant. Le signal choisi comme source modulante fonctionne à cette fréquence dans les limites de fréquence du signal.

Paramètre	Renvoi type
1 µHz à la <b>valeur maximale autorisée pour la fonction interne</b> . Par défaut, 100 Hz	+1,0000000000000000E+04
Réglez la fréquence modulante sur 10 kHz : AM:INT:FUNC 10000	

- Lorsque vous sélectionnez un signal arbitraire comme source modulante, la fréquence devient la fréquence du signal arbitraire, qui est basée sur la fréquence d'échantillonnage et le nombre de points présents dans le signal arbitraire.
- Lorsque vous utilisez un signal arbitraire comme source modulante, la modification de ce paramètre se répercute sur les métadonnées en mémoire cache représentant la fréquence d'échantillonnage du signal arbitraire. Vous pouvez également modifier la fréquence modulante d'un signal arbitraire à l'aide des commandes **FUNcTion:ARBitrary:FREQUency**, **FUNcTion:ARBitrary:PERiod** et **FUNcTion:ARBitrary:SRATe**. Ces commandes et la commande de la fréquence de modulation sont directement couplées afin de maintenir exactement le même comportement du signal arbitraire que lors de sa dernière lecture. Si vous désactivez ultérieurement la modulation et sélectionnez le même signal arbitraire, sa fréquence d'échantillonnage (et la fréquence correspondante en fonction du nombre de points) sera la même que lors de sa lecture comme source de modulation.
- Si la fonction interne est TRIngle, UpRamp ou DnRamp, la fréquence maximale est limitée à 200 kHz sur la série 33500 ou à 800 kHz sur la série 33600. Si la fonction interne est PRBS, la fréquence fait référence au débit binaire et est limitée, **comme indiqué ici**.
- Cette commande doit être utilisée uniquement avec la source de modulation interne (**AM:SOURce INTernal**).

[SOURce[1|2]:]AM:INTernal:FUNctIon <fonction>

[SOURce[1|2]:]AM:INTernal:FUNctIon?

Sélectionne la forme du signal modulant.

Paramètre	Renvoi type
{SINusoid SQUare RAMP NRAMp TRIangle NOISe PRBS ARB}, SINu- soid par défaut, SINusoid par défaut. <a href="#">Afficher les signaux des fonctions internes.</a>	SIN, SQU, RAMP, NRAM, TRI, NOIS, PRBS ou ARB
Sélectionnez un signal sinusoïdal comme signal modulant. AM:INT:FUNC SIN	

- Cette commande doit être utilisée uniquement avec la source de modulation interne (**AM:SOURce INTernal**).
- Une impulsion et le courant continu ne peuvent pas être des signaux porteurs pour la modulation d'amplitude.

[SOURce[1|2]:]AM:SOURce {INTernal|EXTernal|CH1|CH2}

[SOURce[1|2]:]AM:SOURce?

[SOURce[1|2]:]BPSK:SOURce {INTernal|EXTernal}

[SOURce[1|2]:]BPSK:SOURce?

[SOURce[1|2]:]FM:SOURce {INTernal|EXTernal|CH1|CH2}

[SOURce[1|2]:]FM:SOURce?

[SOURce[1|2]:]FSKey:SOURce {INTernal|EXTernal}

[SOURce[1|2]:]FSKey:SOURce?

[SOURce[1|2]:]PM:SOURce {INTernal|EXTernal|CH1|CH2}

[SOURce[1|2]:]PM:SOURce?

[SOURce[1|2]:]PWM:SOURce {INTernal|EXTernal|CH1|CH2}

[SOURce[1|2]:]PWM:SOURce?

Sélectionne la source du signal modulant.

Paramètre	Renvoi type
{INTernal EXTernal CH1 CH2}, INTernal par défaut. BPSK et FSKey n'acceptent pas CH1 ou CH2	INT, EXT, CH1 ou CH2
Sélectionner la source de modulation externe : AM:SOUR EXT (peut également remplacer FM, BPSK, FSK, PM ou PWM pour AM)	

- Si vous sélectionnez EXTERNAL, le signal porteur est modulé par un signal externe. En particulier :
  - **AM** : La profondeur de modulation est contrôlée par le niveau de signal  $\pm 5$  V (ou le niveau de signal  $\pm 1$  V en option sur la série 33600) sur le connecteur **Modulation In** de la face arrière. Par exemple, si la profondeur de modulation (**AM[:DEPTH]**) est de 100 %, lorsque le signal modulant est à +5 V (ou éventuellement de +1 V sur la série 33600), l'amplitude de la sortie est maximale. De même, un signal modulant de -5 V (ou éventuellement de -1 V sur la série 33600) génère une amplitude de sortie minimale.
  - **FM** : Si vous sélectionnez la source modulante *externe*, la variation est contrôlée par le signal  $\pm 5$  V (éventuellement  $\pm 1$  V sur la série 33600) présent sur le connecteur **Modulation In** de la face arrière. Par exemple, si la variation de fréquence est de 100 kHz, un signal +5 V (éventuellement de +1 V sur la série 33600) correspond à une augmentation de fréquence de 100 kHz. Des signaux externes plus faibles produisent une variation moindre et les signaux négatifs réduisent la fréquence au-dessous de la fréquence porteuse.
  - **PM** : Avec la source modulante externe, la variation est contrôlée par le niveau de signal  $\pm 5$  V (éventuellement  $\pm 1$  V sur la série 33600) présent sur le connecteur **Modulation In** de la face arrière. Par exemple, si vous avez réglé la variation de fréquence sur 180 degrés, un niveau de signal +5 V (éventuellement  $\pm 1$  V sur la série 33600) correspond à une variation de +180 degrés. Des signaux externes plus faibles produisent une variation moindre et les signaux négatifs produisent une variation négative.
  - **Impulsion comme fonction sélectionnée** : La largeur d'impulsion ou la variation du rapport cyclique des impulsions est contrôlée par le niveau de signal  $\pm 5$  V (éventuellement  $\pm 1$  V sur la série 33600) présent sur le connecteur **Modulation In** de la face arrière. Par exemple, si vous avez défini la variation de la largeur d'impulsion à 50  $\mu$ s à l'aide de la commande **PWM:DEVIation**, un niveau de signal +5 V (éventuellement +1 V sur la série 33600) correspond à une augmentation de 50  $\mu$ s de la largeur. Des tensions externes inférieures produisent une variation inférieure.
- Avec la source EXTERNAL, la phase (BPSK) ou la fréquence (FSK) de sortie est déterminée par le niveau du signal sur le connecteur **Ext Trig** de la face arrière. Lorsque le niveau logique est bas, la phase ou la fréquence porteuse est envoyée. Lorsque le niveau logique est haut, le déphasage ou la fréquence de saut est envoyée.
- La fréquence externe maximale BPSK est de 1 MHz et la fréquence maximale FSK, de 1 MHz.
- **Remarque** : le connecteur utilisé pour les signaux BPSK ou FSK déclenchés extérieurement (**Trig In**) n'est pas le même que celui utilisé pour les signaux modulés extérieurement AM, FM, PM et PWM (**Modulation In**). Lorsqu'il est utilisé pour BPSK ou FSK, la polarité des fronts sur le connecteur **Trig In** n'est pas réglable ; ce connecteur n'est pas affecté par la commande **TRIGGER[1|2]:SLOPe**.
- Avec la source INTERNAL, la vitesse de commutation de la phase (BPSK) ou de la fréquence (FSKey) de sortie entre la phase ou la fréquence porteuse et la phase ou la fréquence alternative est déterminée par la vitesse BPSK (**BPSK:INTERNAL:RATE**) ou FSK (**FSKey:INTERNAL:RATE**).
- Une voie ne peut pas être sa propre source de modulation.

## Voir également

**INPut:ATTenuation[:STATe]**

**Sous-système AM**

Sous-système BPSK

Sous-système FM

Sous-système FSKey

Sous-système PM

Sous-système PWM

[SOURCE[1|2]:]AM:STATe {ON|1|OFF|0}  
[SOURCE[1|2]:]AM:STATe?

[SOURCE[1|2]:]BPSK:STATe {ON|1|OFF|0}  
[SOURCE[1|2]:]BPSK:STATe?

[SOURCE[1|2]:]FM:STATe {ON|1|OFF|0}  
[SOURCE[1|2]:]FM:STATe?

[SOURCE[1|2]:]FSKey:STATe {ON|1|OFF|0}  
[SOURCE[1|2]:]FSKey:STATe?

[SOURCE[1|2]:]PM:STATe {ON|1|OFF|0}  
[SOURCE[1|2]:]PM:STATe?

[SOURCE[1|2]:]PWM:STATe {ON|1|OFF|0}  
[SOURCE[1|2]:]PWM:STATe?

Active ou désactive la modulation.

Paramètre	Renvoi type
{ON 1 OFF 0}, OFF par défaut	0 (OFF) ou 1 (ON)
Activer la modulation AM (peut également être FM, BPSK, FSK, PM ou PWM) : AM:STAT ON	

- Pour éviter plusieurs modifications des signaux, activez la modulation après avoir configuré les autres paramètres de modulation.
- Vous ne pouvez activer qu'un seul mode de modulation à la fois.
- L'instrument n'active pas la modulation lorsque le mode balayage ou rafale est activé. Lorsque vous activez la modulation, le mode balayage ou rafale est désactivé.
- La modulation PWM est autorisée uniquement lorsque la fonction d'impulsion est sélectionnée.

#### Voir également

[Sous-système AM](#)

[Sous-système BPSK](#)

[Sous-système FM](#)

[Sous-système FSKey](#)

[Sous-système PM](#)

[Sous-système PWM](#)

## Sous-système APPLy

Le sous-système APPLy permet de configurer des signaux complets en une seule commande. La forme générale de la commande APPLy est indiquée ci-dessous :

```
[SOURce[1|2]:]APPLy:<fonction> [<fréquence> [,<amplitude> [,<tension résiduelle>]]]
```

Par exemple,

```
APPLy:SIN 1e4,1,0.1
```

remplace les commandes suivantes :

```
FUNCtion SIN  
FREQ 1e4  
VOLT 1  
VOLT:OFF 0,1  
OUTP ON
```

Non seulement la commande APPLy est rapide, mais elle évite également les conflits de paramètres qui peuvent se produire en envoyant des commandes individuelles. De plus, la commande APPLy effectue les opérations suivantes :

- Définit la source de déclenchement sur IMMEDIATE (équivalent à TRIGger[1|2]:SOURce IMMEDIATE).
- Désactive le mode modulation, balayage ou rafale activé et place l'instrument en mode signal continu.
- Active la sortie de la voie (OUTPut ON) sans modifier le réglage de la terminaison de sortie (OUTPut [1|2]:LOAD).
- Remplace le réglage de détection automatique de la tension et active la sélection automatique de la plage (VOLTage:RANGe:AUTO).

L'instrument peut générer 8 types de signaux : tension CC, bruit gaussien, PRBS, impulsion, rampe/triangle, signal sinusoïdal, signal carré et signal arbitraire (défini par l'utilisateur). Le sous-système FUNCtion inclut des paramètres propres aux signaux.

Vous pouvez également demander la configuration actuelle de la sortie (APPLy?).

### Remarques générales

#### Amplitude

- La modification de l'amplitude peut interrompre brièvement la sortie à certaines tensions en raison de la commutation de l'atténuateur de sortie. Néanmoins, l'amplitude est contrôlée de façon que la tension de sortie ne soit jamais supérieure au réglage actuel lorsque la commutation a lieu. Pour éviter cette interruption, désactivez la détection automatique de la tension à l'aide de la commande VOLTage:RANGe:AUTO OFF. La commande APPLy active automatiquement la détection automatique.
- Limites imposées par l'impédance de sortie : La plage de la tension résiduelle dépend de l'impédance de sortie. Par exemple, si vous configurez une tension résiduelle de 100 mVcc et modifiez ensuite



l'impédance de sortie de 50 Ω à « haute impédance », la tension résiduelle affichée sur la face avant est multipliée par deux et passe à 200 mVcc (aucune erreur générée). Si vous passez de « haute impédance » à 50 Ω, la tension résiduelle affichée est divisée par deux. Pour plus d'informations, reportez-vous à la commande **OUTPut[1|2]:LOAD**.

- Limites imposées par la sélection de l'unité : l'unité de sortie sélectionnée détermine les limites d'amplitude.
- Vous ne pouvez pas spécifier l'amplitude de sortie en dBm si la terminaison de sortie est réglée sur une impédance élevée. Les unités sont automatiquement converties en Volts crête/crête (Vpp).

## Commandes et requêtes

[SOURce[1|2]:]APPLy?

[SOURce[1|2]:]APPLy:ARBitrary [{< fréquence\_échantillonnage >|MIN|MAX|DEF} [, {< amplitude >|MIN|MAX|DEF} [, {< tension résiduelle >|MIN|MAX|DEF}]]]

[SOURce[1|2]:]APPLy:DC

[SOURce[1|2]:]APPLy:NOISe

[SOURce[1|2]:]APPLy:PRBS

[SOURce[1|2]:]APPLy:PULSe

[SOURce[1|2]:]APPLy:RAMP

[SOURce[1|2]:]APPLy:SINusoid

[SOURce[1|2]:]APPLy:SQUare

[SOURce[1|2]:]APPLy:TRIangle

[SOURce[1|2]:]APPLy?

Demande la configuration de la sortie.

Paramètre	Renvoi type
(aucun)	"SIN +5,000000000000000E+03, +3,000000000000000E+00, -2,500000000000000E+00"
Renvoie la configuration d'un signal sinusoïdal 5 kHz / 3 V avec une tension résiduelle de -2,5 Vcc. APPLY?	

- La fonction, la fréquence, l'amplitude et la tension résiduelle sont renvoyées, comme indiqué ci-dessus. L'amplitude, mais pas la tension résiduelle, est renvoyée telle qu'elle est spécifiée par **VOLTage:UNIT**.

[SOURce[1|2]:]APPLy:ARBitrary [{<fréquence\_échantillonnage>|MIN|MAX|DEF} [, {<amplitude>|MIN|MAX|DEF} [, {<tension\_résiduelle>|MIN|MAX|DEF}]]]

Envoie à la sortie le signal arbitraire sélectionné par FUNCTION: ARBitrary en utilisant la fréquence d'échantillonnage, l'amplitude et la tension résiduelle spécifiées.

Paramètre	Renvoi type
<fréquence_échantillonnage> de 1 µSa/s à 250 M.éch/s (série 33500) ou 1 Géch/s (série 33600), 40 M.éch/s par défaut	(aucun)
<amplitude> de 1 mVpp à 10 Vpp dans 50 Ω, 2 mVpp à 20 Vpp dans un circuit ouvert, 100 mVpp par défaut dans 50 Ω	
<tension_résiduelle> correspond à la tension CC résiduelle (0 par défaut), provenant d'un signal ±5 Vcc dans une charge de 50 Ω ou d'un signal ±10 Vcc dans un circuit ouvert.	
Envoyer le signal arbitraire sélectionné à l'aide de la commande FUNCTION:ARBitrary:APPLy:ARBitrary 1 kHz, 5,0, -2,5 V	

### Généralités

- La définition d'une fréquence d'échantillonnage en mode non ARB ne modifie pas la fréquence. Par exemple, si la fonction active est un signal sinusoïdal (sine), la définition de la fréquence d'échantillonnage n'a pas d'effet tant que la fonction n'est pas modifiée à ARB.
- Des fréquences d'échantillonnage élevées peuvent affecter l'amplitude réelle en raison d'une oscillation du filtre.

### Options

- Voir FUNCTION: ARBitrary pour connaître les options de signaux arbitraires disponibles. Avec FUNCTION:ARBitrary, vous pouvez sélectionner un signal arbitraire intégré ou le signal actuellement téléchargé en mémoire volatile à l'aide des commandes **MMEMory**.

### Tension résiduelle

- Le rapport entre la tension résiduelle et l'amplitude de sortie est illustré ci-dessous. Vmax est la tension de crête maximale compte tenu de l'impédance de sortie déclarée (soit 50 Ω pour une charge de 50 Ω ou 10 V pour une charge haute impédance).

$$|V_{\text{offset}}| < V_{\text{max}} - V_{\text{pp}}/2$$

Si la tension résiduelle saisie est incorrecte, l'instrument la règle au niveau maximal autorisé avec l'amplitude spécifiée. Sur l'interface distante, l'erreur « Data out of range » est également générée.

- Limites imposées par l'impédance de sortie : La plage de la tension résiduelle dépend de l'impédance de sortie. Par exemple, si vous configurez une tension résiduelle de 100 mVcc et modifiez ensuite l'impédance de sortie de 50 Ω à « haute impédance », la tension résiduelle affichée sur la face avant est multipliée par deux et passe à 200 mVcc (aucune erreur générée). Si vous passez de « haute impédance

» à 50  $\Omega$ , la tension résiduelle affichée est divisée par deux. Pour plus d'informations, reportez-vous à la commande **OUTPut[1|2]:LOAD**.

**[SOURce[1|2]:]APPLy:DC [{<fréquence>|MIN|MAX|DEF} [, {<amplitude>|MIN|MAX|DEF} [, {<tension résiduelle>|MIN|MAX|DEF}]]]**

Envoie une tension CC résiduelle.

Paramètre	Renvoi type
<fréquence> non applicable à la fonction CC. Doit être spécifié comme un emplacement réservé ; cette valeur est conservée lorsque vous passez à une autre fonction.	(aucun)
<amplitude> non applicable à la fonction CC. Doit être spécifié comme un emplacement réservé ; cette valeur est conservée lorsque vous passez à une autre fonction.	
<tension résiduelle> correspond à la tension CC résiduelle (0 par défaut), provenant d'un signal $\pm 5$ Vcc dans une charge de 50 $\Omega$ ou d'un signal $\pm 10$ Vcc dans un circuit ouvert.	
Envoyer une tension CC de -2,5 V : APPLy:DC DEF, DEF, -2,5 V	

- Limites imposées par l'impédance de sortie : La plage de la tension résiduelle dépend de l'impédance de sortie. Par exemple, si vous configurez une tension résiduelle de 100 mVcc et modifiez ensuite l'impédance de sortie de 50  $\Omega$  à « haute impédance », la tension résiduelle affichée sur la face avant est multipliée par deux et passe à 200 mVcc (aucune erreur générée). Si vous passez de « haute impédance » à 50  $\Omega$ , la tension résiduelle affichée est divisée par deux. Pour plus d'informations, reportez-vous à la commande **OUTPut[1|2]:LOAD**. La modification de l'impédance de sortie n'a aucune répercussion sur la tension aux bornes de sortie de l'instrument. Seules les valeurs affichées sur la face avant et les valeurs demandées sur l'interface distante sont modifiées. La tension sur la sortie de l'instrument dépend de la charge connectée à l'instrument. Pour plus d'informations, reportez-vous à la commande **OUTPut[1|2]:LOAD**.

[SOURce[1|2]:]APPLy:NOISe [{<fréquence>|MIN|MAX|DEF} [, {<amplitude>|MIN|MAX|DEF} [, {<tension résiduelle>|MIN|MAX|DEF}]]]

Envoie un bruit gaussien avec l'amplitude et la tension résiduelle CC spécifiées.

Paramètre	Renvoi type
<fréquence> non applicable à la fonction de bruit. Doit être spécifié comme un emplacement réservé ; cette valeur est conservée lorsque vous passez à une autre fonction.	(aucun)
<amplitude> Amplitude de sortie souhaitée en Vpp, Veff ou dBm, spécifiée par la commande <b>VOLTage:UNIT</b> . 1 mVpp à 10 Vpp dans une charge de 50 Ω ou 2 fois ces valeurs dans un circuit ouvert.  Si l'amplitude est spécifiée en Vpp, la sortie crête à crête sera réellement envoyée très rarement en raison de la nature du bruit gaussien.	
<tension résiduelle> correspond à la tension CC résiduelle (0 par défaut), provenant d'un signal ±5 Vcc dans une charge de 50 Ω ou d'un signal ±10 Vcc dans un circuit ouvert.	
Envoyer un bruit gaussien limité à 3 Vpp avec une tension résiduelle de -2,5 V : APPL:NOIS 5 KHZ, 3,0 V, -2,5 V	

### Fréquence

- Si vous spécifiez une fréquence, celle-ci n'a pas d'impact sur la sortie du bruit, mais sa valeur est conservée lorsque vous sélectionnez une autre fonction.
- Pour plus d'informations sur la modification de la bande passante du bruit, voir **FUNCTION:NOISe:BANDwidth**.

### Tension résiduelle

- Le rapport entre la tension résiduelle et l'amplitude de sortie est illustré ci-dessous.  $V_{max}$  est la tension de crête maximale compte tenu de l'impédance de sortie déclarée (soit 50 Ω pour une charge de 50 Ω ou 10 V pour une charge haute impédance).

$$|V_{offset}| < V_{max} - V_{pp}/2$$

Si la tension résiduelle saisie est incorrecte, l'instrument la règle au niveau maximal autorisé avec l'amplitude spécifiée.

Sur l'interface distante, l'erreur « Data out of range » est également générée.

- Limites imposées par l'impédance de sortie : La plage de la tension résiduelle dépend de l'impédance de sortie. Par exemple, si vous configurez une tension résiduelle de 100 mVcc et modifiez ensuite l'impédance de sortie de 50 Ω à « haute impédance », la tension résiduelle affichée sur la face avant est multipliée par deux et passe à 200 mVcc (aucune erreur générée). Si vous passez de « haute impédance » à 50 Ω, la tension résiduelle affichée est divisée par deux. Pour plus d'informations, reportez-vous à la commande **OUTPUT[1|2]:LOAD**.

[SOURce[1|2]:]APPLY:PRBS [{<fréquence>|MIN|MAX|DEF} [, {<amplitude>|MIN|MAX|DEF} [, {<tension résiduelle>|MIN|MAX|DEF}]]]

Envoie une séquence binaire pseudo-aléatoire avec le débit binaire, l'amplitude et la tension résiduelle spécifiés.

Le signal par défaut est un générateur de registre à décalage de longueur maximale PN7.

Paramètre	Renvoi type
<fréquence> en bits/s, 1 000 par défaut	(aucun)
<amplitude> Amplitude de sortie souhaitée en Vpp, Veff ou dBm, spécifiée par la commande <b>VOLTage:UNIT</b> . 1 mVpp à 10 Vpp dans une charge de 50 Ω ou 2 fois ces valeurs dans un circuit ouvert. La valeur par défaut est de 100 mVpp dans une charge de 50 Ω.	
<tension résiduelle> correspond à la tension CC résiduelle (0 par défaut), provenant d'un signal ±5 Vcc dans une charge de 50 Ω ou d'un signal ±10 Vcc dans un circuit ouvert.	
Envoyer une séquence binaire pseudo aléatoire (PRBS) limitée à 3 Vpp avec une tension résiduelle de -2,5 V : APPL:PRBS 5 KHZ, 3,0 V, -2,5 V	

### Fréquence

- La séquence PRBS est créée par un générateur MLS (Maximum Length Sequence) (registre à décalage à retour linéaire) qu'il est possible de configurer avec plusieurs configurations standard. La configuration par défaut est PN7 à 1 000 bits/seconde.
- Un signal PRBS utilisant le polynôme PN $x$  est créé par un registre à décalage de  $x$  bits. Le signal de sortie commence par  $x$  périodes d'échantillonnage de haut débit. La période d'échantillonnage est l'inverse de la fréquence d'échantillonnage (**FUNCTION:PRBS:BRATe**) et l'impulsion **Sync** de la voie indique le début du signal. Par exemple, si le signal PRBS utilise PN23 avec une fréquence d'échantillonnage de 500 Hz, la sortie commence avec une fréquence haut débit de 46 ms (23 x 2 ms).
- À la différence de la fonction APPLY:NOISE, la fonction APPLY:PRBS fonctionne avec la sortie **Sync** activée. La fonction **Sync** indique le début de la séquence pseudo-aléatoire.

### Tension résiduelle

- Le rapport entre la tension résiduelle et l'amplitude de sortie est illustré ci-dessous. Vmax est la tension de crête maximale compte tenu de l'impédance de sortie déclarée (soit 50 V pour une charge de 50 Ω ou 10 V pour une charge haute impédance).

$$|\text{Voffset}| < V_{\text{max}} - V_{\text{pp}}/2$$

Si la tension résiduelle saisie est incorrecte, l'instrument la règle au niveau maximal autorisé avec l'amplitude spécifiée. Sur l'interface distante, l'erreur « Data out of range » est également générée.

- Limites imposées par l'impédance de sortie : La plage de la tension résiduelle dépend de l'impédance de sortie. Par exemple, si vous configurez une tension résiduelle de 100 mVcc et modifiez ensuite l'impédance de sortie de 50 Ω à « haute impédance », la tension résiduelle affichée sur la face avant est

multipliée par deux et passe à 200 mVcc (aucune erreur générée). Si vous passez de « haute impédance » à 50  $\Omega$ , la tension résiduelle affichée est divisée par deux. Pour plus d'informations, reportez-vous à la commande **OUTPut[1|2]:LOAD**.

[SOURce[1|2]:]APPLY:PULSe [{<fréquence>|MIN|MAX|DEF} [, {<amplitude>|MIN|MAX|DEF} [, {<tension résiduelle>|MIN|MAX|DEF}]]]

Envoie un train d'impulsions avec l'amplitude, la fréquence et la tension résiduelle CC spécifiées. De plus, la commande **APPLY** effectue les opérations suivantes :

- Conserve la largeur d'impulsion actuelle (FUNCTION:PULSe:WIDTh) ou le rapport cyclique actuel des impulsions (FUNCTION:PULSe:DCYClE).
- Conserve le temps de transition actuel (FUNCTION:PULSe:TRANSition[:BOTH]).
- L'instrument peut ignorer la largeur d'impulsion ou le temps de font pour être conforme à la fréquence ou la période spécifiée (FUNCTION:PULSe:PERiod).

Paramètre	Renvoi type
<fréquence> en Hz, par défaut 1 kHz	(aucun)
<amplitude> Amplitude de sortie souhaitée en Vpp, Veff ou dBm, spécifiée par la commande <b>VOLTage:UNIT</b> . 1 mVpp à 10 Vpp dans une charge de 50 Ω ou 2 fois ces valeurs dans un circuit ouvert. La valeur par défaut est de 100 mVpp dans une charge de 50 Ω.	
<tension résiduelle> correspond à la tension CC résiduelle (0 par défaut), provenant d'un signal ±5 Vcc dans une charge de 50 Ω ou d'un signal ±10 Vcc dans un circuit ouvert.	
Envoyer un train d'impulsions de 5 Vpp à 1 kHz avec une tension résiduelle de -2,5 V : APPL:PULS 1 kHz, 5,0 V, -2,5 V	

### Fréquence

- La commande **APPLY** doit être adaptée à la fonction. Par exemple, **APPL:PULS 300 MHz** génère l'erreur « Data out of range ». Dans ce cas, la fréquence est définie à la **fréquence maximale de l'instrument pour une impulsion**.

### Tension résiduelle

- Le rapport entre la tension résiduelle et l'amplitude de sortie est illustré ci-dessous.  $V_{max}$  est la tension de crête maximale compte tenu de l'impédance de sortie déclarée (soit 50 V pour une charge de 50 Ω ou 10 V pour une charge haute impédance).

$$|V_{offset}| < V_{max} - V_{pp}/2$$

Si la tension résiduelle saisie est incorrecte, l'instrument la règle au niveau maximal autorisé avec l'amplitude spécifiée. Sur l'interface distante, l'erreur « Data out of range » est également générée.

- Limites imposées par l'impédance de sortie : La plage de la tension résiduelle dépend de l'impédance de sortie. Par exemple, si vous configurez une tension résiduelle de 100 mVcc et modifiez ensuite l'impédance de sortie de 50 Ω à « haute impédance », la tension résiduelle affichée sur la face avant est multipliée par deux et passe à 200 mVcc (aucune erreur générée). Si vous passez de « haute impédance

» à 50  $\Omega$ , la tension résiduelle affichée est divisée par deux. Pour plus d'informations, reportez-vous à la commande `OUTPut[1|2]:LOAD`.



[SOURce[1|2]:]APPLY:RAMP [{<fréquence>|MIN|MAX|DEF} [, {<amplitude>|MIN|MAX|DEF} [, {<tension résiduelle>|MIN|MAX|DEF}]]]

[SOURce[1|2]:]APPLY:TRiangle [{<fréquence>|MIN|MAX|DEF} [, {<amplitude>|MIN|MAX|DEF} [, {<tension résiduelle>|MIN|MAX|DEF}]]]

Envoie un signal de rampe ou triangulaire avec l'amplitude, la fréquence et la tension résiduelle CC spécifiées. De plus, la commande **APPLY** effectue les opérations suivantes :

- APPLY:RAMP ignore le paramètre actuel de symétrie (**FUNCTION:RAMP:SYMMetry**) et définit la symétrie à 100 % pour la rampe.
- APPLY:TRiangle est simplement un cas particulier de la commande APPLY:RAMP. Cette commande est équivalente à une rampe dotée d'une symétrie de 50 %.

Paramètre	Renvoi type
<fréquence> en Hz, par défaut 1 kHz	(aucun)
<amplitude> Amplitude de sortie souhaitée en Vpp, Veff ou dBm, spécifiée par la commande <b>VOLTage:UNIT</b> . 1 mVpp à la <b>valeur maximale autorisée pour le modèle d'instrument et le signal</b> dans une charge de 50 Ω ou deux fois ces valeurs dans un circuit ouvert. La valeur par défaut est de 100 mVpp dans une charge de 50 Ω.	
<tension résiduelle> correspond à la tension CC résiduelle (0 par défaut), provenant d'un signal ±5 Vcc dans une charge de 50 Ω ou d'un signal ±10 Vcc dans un circuit ouvert.	
Configurer une rampe de 5 V à 3 kHz avec une tension résiduelle de 0 V : APPL:RAMP 3 KHZ, 5,0 V, 0	

### Fréquence

- La commande APPLY doit être adaptée à la fonction. Par exemple, la commande APPL:RAMP 5 MHz génère l'erreur « Data out of range ». Dans ce cas, la fréquence doit être réglée sur 200 kHz, fréquence maximale pour une rampe.

### Tension résiduelle

- Le rapport entre la tension résiduelle et l'amplitude de sortie est illustré ci-dessous. Vmax est la tension de crête maximale compte tenu de l'impédance de sortie déclarée (soit 50 V pour une charge de 50 Ω ou 10 V pour une charge haute impédance).

$$|V_{\text{offset}}| < V_{\text{max}} - V_{\text{pp}}/2$$

Si la tension résiduelle saisie est incorrecte, l'instrument la règle au niveau maximal autorisé avec l'amplitude spécifiée. Sur l'interface distante, l'erreur « Data out of range » est également générée.

- Limites imposées par l'impédance de sortie : La plage de la tension résiduelle dépend de l'impédance de sortie. Par exemple, si vous configurez une tension résiduelle de 100 mVcc et modifiez ensuite l'impédance de sortie de 50 Ω à « haute impédance », la tension résiduelle affichée sur la face avant est

multipliée par deux et passe à 200 mVcc (aucune erreur générée). Si vous passez de « haute impédance » à 50 Ω, la tension résiduelle affichée est divisée par deux. Pour plus d'informations, reportez-vous à la commande **OUTPut[1|2]:LOAD**.

**[SOURce[1|2]:]APPLY:SINusoid [{<fréquence>|MIN|MAX|DEF} [, {<amplitude>|MIN|MAX|DEF} [, {<tension résiduelle>|MIN|MAX|DEF}]]]**

Envoie un signal sinusoïdal avec l'amplitude, la fréquence et la tension résiduelle CC spécifiées.

Paramètre	Renvoi type
<p>&lt;fréquence&gt; de 1 μHz à la <b>fréquence maximale</b> de l'instrument. Par défaut, 1 kHz.</p>	(aucun)
<p>&lt;amplitude&gt; Amplitude de sortie souhaitée en Vpp, Veff ou dBm, spécifiée par la commande <b>VOLTage:UNIT</b>.  1 mVpp à la <b>valeur maximale autorisée pour le modèle d'instrument et le signal</b> dans une charge de 50 Ω ou deux fois ces valeurs dans un circuit ouvert. La valeur par défaut est de 100 mVpp dans une charge de 50 Ω.</p>	
<p>&lt;tension résiduelle&gt; correspond à la tension CC résiduelle (0 par défaut), provenant d'un signal ±5 Vcc dans une charge de 50 Ω ou d'un signal ±10 Vcc dans un circuit ouvert.</p>	
<p>Envoyer un signal sinusoïdal de 3 Vpp à 5 kHz avec une tension résiduelle de -2,5 V : APPL:SIN 5 KHZ, 3,0 VPP, -2,5 V</p>	

### Tension résiduelle

- Le rapport entre la tension résiduelle et l'amplitude de sortie est illustré ci-dessous. Vmax est la tension de crête maximale compte tenu de l'impédance de sortie déclarée (soit 50 V pour une charge de 50 Ω ou 10 V pour une charge haute impédance).

$$|V_{\text{offset}}| < V_{\text{max}} - V_{\text{pp}}/2$$

Si la tension résiduelle saisie est incorrecte, l'instrument la règle au niveau maximal autorisé avec l'amplitude spécifiée. Sur l'interface distante, l'erreur « Data out of range » est également générée.

- Limites imposées par l'impédance de sortie : La plage de la tension résiduelle dépend de l'impédance de sortie. Par exemple, si vous configurez une tension résiduelle de 100 mVcc et modifiez ensuite l'impédance de sortie de 50 Ω à « haute impédance », la tension résiduelle affichée sur la face avant est multipliée par deux et passe à 200 mVcc (aucune erreur générée). Si vous passez de « haute impédance » à 50 Ω, la tension résiduelle affichée est divisée par deux. Pour plus d'informations, reportez-vous à la commande **OUTPut[1|2]:LOAD**.

[SOURce[1|2]:]APPLY:SQUare [{<fréquence>|MIN|MAX|DEF} [,]{<amplitude>|MIN|MAX|DEF} [,]{<tension résiduelle>|MIN|MAX|DEF}]]

Envoie un signal carré avec l'amplitude, la fréquence et la tension résiduelle CC spécifiées. De plus, **APPLY:SQUare** ignore le rapport cyclique actuel (FUNCTION:SQUare:DCYClE) et configure un rapport cyclique de 50 % pour le signal carré.

Paramètre	Renvoi type
<p>&lt;fréquence&gt;</p> <p>de 1 µHz à la <b>fréquence maximale</b> de l'instrument.</p> <p>Par défaut, 1 kHz.</p>	(aucun)
<p>&lt;amplitude&gt; Amplitude de sortie souhaitée en Vpp, Veff ou dBm, spécifiée par la commande <b>VOLTage:UNIT</b>.</p> <p>1 mVpp à la <b>valeur maximale autorisée pour le modèle d'instrument et le signal</b> dans une charge de 50 Ω ou deux fois ces valeurs dans un circuit ouvert. La valeur par défaut est de 100 mVpp dans une charge de 50 Ω.</p>	
<p>&lt;tension résiduelle&gt; correspond à la tension CC résiduelle (0 par défaut), provenant d'un signal ±5 Vcc dans une charge de 50 Ω ou d'un signal ±10 Vcc dans un circuit ouvert.</p>	
<p>Envoyer un signal carré de 3 V à 5 kHz avec une tension résiduelle de -2,5 V :</p> <p>APPL:SQU 5 KHZ, 3,0 V, -2,5 V</p>	

### Fréquence

- La commande APPLY doit être adaptée à la fonction. Par exemple, la commande APPL:SQU 40 MHz génère l'erreur « Data out of range » et l'instrument définit la fréquence à la **fréquence maximale pour un signal carré**.

### Tension résiduelle

- Le rapport entre la tension résiduelle et l'amplitude de sortie est illustré ci-dessous. Vmax est la tension de crête maximale compte tenu de l'impédance de sortie déclarée (soit 50 V pour une charge de 50 Ω ou 10 V pour une charge haute impédance).

$$|V_{\text{offset}}| < V_{\text{max}} - V_{\text{pp}}/2$$

Si la tension résiduelle saisie est incorrecte, l'instrument la règle au niveau maximal autorisé avec l'amplitude spécifiée. Sur l'interface distante, l'erreur « Data out of range » est également générée.

- Limites imposées par l'impédance de sortie : La plage de la tension résiduelle dépend de l'impédance de sortie. Par exemple, si vous configurez une tension résiduelle de 100 mVcc et modifiez ensuite l'impédance de sortie de 50 Ω à « haute impédance », la tension résiduelle affichée sur la face avant est multipliée par deux et passe à 200 mVcc (aucune erreur générée). Si vous passez de « haute impédance » à 50 Ω, la tension résiduelle affichée est divisée par deux. Pour plus d'informations, reportez-vous à la commande **OUTPut[1|2]:LOAD**.

## Sous-système BPSK

Le sous-système BPSK permet de moduler un signal avec le format de modulation par déplacement de fréquence binaire (BPSK). En mode BPSK, le signal porteur est déphasé entre deux phases au moyen d'une clé on/off. La source peut être interne en utilisant un signal carré à une fréquence donnée, ou externe en utilisant l'entrée de déclenchement externe.

Si la fonction porteuse est un signal arbitraire, le déphasage n'affecte que la position des transitions d'échantillons. Cela diffère du décalage de la phase du signal arbitraire global.

### Exemple

Pour générer un signal BPSK :

1. **Configurez le signal porteur** : Utilisez les commandes **FUNCTION**, **FREQUENCY**, **VOLTage** et **VOLTage:OFFSet** pour spécifier la fonction du signal, sa fréquence, son amplitude et sa tension résiduelle.
2. **Sélectionnez la source de modulation (interne, externe, CH1 ou CH2)** : **BPSK:SOURce**. Pour une source externe, ignorez les opérations 4 et 3 ci-dessous.
3. **Sélectionnez la phase BPSK** : **BPSK[:PHASe]**
4. **Définissez la cadence BPSK** : **BPSK:INTernal:RATE**
5. **Activez la modulation BPSK** : **BPSK:STATe ON**

Le code suivant produit l'image d'oscilloscope illustrée ci-dessous.

```
FUNCTION SQU
FREQUENCY +1,0E+04
VOLTage +1,0
VOLTage:OFFset 0,0
BPSK:SOURce INT
BPSK:INTernal:RATE +3000
BPSK:PHASe +90
BPSK:STATe 1
OUTPut1 1
```

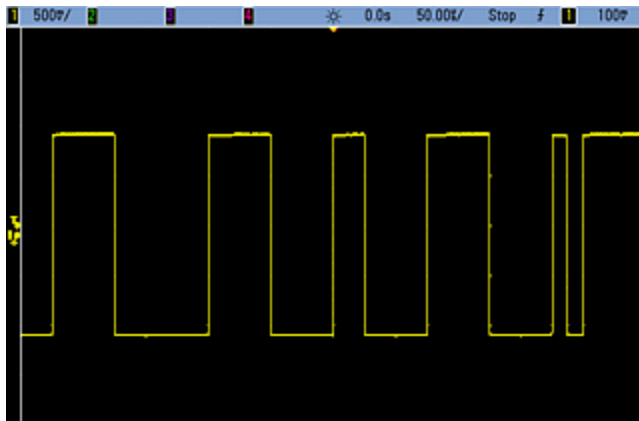

[SOURce[1|2]:]BPSK:INTernal:RATE {<fréquence\_modulante>|MINimum|MAXimum|DEFault}  
[SOURce[1|2]:]BPSK:INTernal:RATE? [{MINimum|MAXimum}]

Définit la cadence à laquelle la phase du signal de sortie « passe » de la phase porteuse à la phase décalée.

Paramètre	Renvoi type
1 mHZ à 1 MHz, 10 Hz par défaut	+1,0000000000000000E-03
Régler la cadence BPSK sur 1 mHz : BPSK:INT:RATE MIN	

- La cadence BPSK est *uniquement* utilisée lorsque la source *INTernal* est sélectionnée (**BPSK:SOURce INTernal**) ; elle est ignorée lorsque la source *EXTernal* est sélectionnée (**BPSK:SOURce EXTernal**).
- Le signal modulant interne est un signal carré présentant un rapport cyclique de 50 %.

[SOURce[1|2]:]BPSK[:PHASe] {<angle>|MINimum|MAXimum|DEFault}  
[SOURce[1|2]:]BPSK[:PHASe]? [{MINimum|MAXimum}]

Définit la phase BPSK en degrés.

Paramètre	Renvoi type
0 à +360 degrés, 180 par défaut	+1,8000000000000000E+02
Définir le déphasage à 90 degrés : BPSK:PHAS 90	

[SOURce[1|2]:]AM:SOURce {INTernal|EXTernal|CH1|CH2}  
[SOURce[1|2]:]AM:SOURce?

[SOURce[1|2]:]BPSK:SOURce {INTernal|EXTernal}  
[SOURce[1|2]:]BPSK:SOURce?

[SOURce[1|2]:]FM:SOURce {INTernal|EXTernal|CH1|CH2}  
[SOURce[1|2]:]FM:SOURce?

[SOURce[1|2]:]FSKey:SOURce {INTernal|EXTernal}  
[SOURce[1|2]:]FSKey:SOURce?

[SOURce[1|2]:]PM:SOURce {INTernal|EXTernal|CH1|CH2}  
[SOURce[1|2]:]PM:SOURce?

[SOURce[1|2]:]PWM:SOURce {INTernal|EXTernal|CH1|CH2}  
[SOURce[1|2]:]PWM:SOURce?

Sélectionne la source du signal modulant.

Paramètre	Renvoi type
{INTernal EXTernal CH1 CH2}, INTernal par défaut. BPSK et FSKey n'acceptent pas CH1 ou CH2	INT, EXT, CH1 ou CH2
Sélectionner la source de modulation externe : AM:SOUR EXT (peut également remplacer FM, BPSK, FSK, PM ou PWM pour AM)	

- Si vous sélectionnez EXTERNAL, le signal porteur est modulé par un signal externe. En particulier :
  - **AM** : La profondeur de modulation est contrôlée par le niveau de signal  $\pm 5$  V (ou le niveau de signal  $\pm 1$  V en option sur la série 33600) sur le connecteur **Modulation In** de la face arrière. Par exemple, si la profondeur de modulation (**AM[:DEPTH]**) est de 100 %, lorsque le signal modulant est à +5 V (ou éventuellement de +1 V sur la série 33600), l'amplitude de la sortie est maximale. De même, un signal modulant de -5 V (ou éventuellement de -1 V sur la série 33600) génère une amplitude de sortie minimale.
  - **FM** : Si vous sélectionnez la source modulante *externe*, la variation est contrôlée par le signal  $\pm 5$  V (éventuellement  $\pm 1$  V sur la série 33600) présent sur le connecteur **Modulation In** de la face arrière. Par exemple, si la variation de fréquence est de 100 kHz, un signal +5 V (éventuellement de +1 V sur la série 33600) correspond à une augmentation de fréquence de 100 kHz. Des signaux externes plus faibles produisent une variation moindre et les signaux négatifs réduisent la fréquence au-dessous de la fréquence porteuse.
  - **PM** : Avec la source modulante externe, la variation est contrôlée par le niveau de signal  $\pm 5$  V (éventuellement  $\pm 1$  V sur la série 33600) présent sur le connecteur **Modulation In** de la face arrière. Par exemple, si vous avez réglé la variation de fréquence sur 180 degrés, un niveau de signal +5 V (éventuellement  $\pm 1$  V sur la série 33600) correspond à une variation de +180 degrés. Des signaux externes plus faibles produisent une variation moindre et les signaux négatifs produisent une variation négative.
  - **Impulsion comme fonction sélectionnée** : La largeur d'impulsion ou la variation du rapport cyclique des impulsions est contrôlée par le niveau de signal  $\pm 5$  V (éventuellement  $\pm 1$  V sur la série 33600) présent sur le connecteur **Modulation In** de la face arrière. Par exemple, si vous avez défini la variation de la largeur d'impulsion à 50  $\mu$ s à l'aide de la commande **PWM:DEVIation**, un niveau de signal +5 V (éventuellement +1 V sur la série 33600) correspond à une augmentation de 50  $\mu$ s de la largeur. Des tensions externes inférieures produisent une variation inférieure.
- Avec la source EXTERNAL, la phase (BPSK) ou la fréquence (FSK) de sortie est déterminée par le niveau du signal sur le connecteur **Ext Trig** de la face arrière. Lorsque le niveau logique est bas, la phase ou la fréquence porteuse est envoyée. Lorsque le niveau logique est haut, le déphasage ou la fréquence de saut est envoyée.
- La fréquence externe maximale BPSK est de 1 MHz et la fréquence maximale FSK, de 1 MHz.
- **Remarque** : le connecteur utilisé pour les signaux BPSK ou FSK déclenchés extérieurement (**Trig In**) n'est pas le même que celui utilisé pour les signaux modulés extérieurement AM, FM, PM et PWM (**Modulation In**). Lorsqu'il est utilisé pour BPSK ou FSK, la polarité des fronts sur le connecteur **Trig In** n'est pas réglable ; ce connecteur n'est pas affecté par la commande **TRIGGER[1|2]:SLOPe**.
- Avec la source INTERNAL, la vitesse de commutation de la phase (BPSK) ou de la fréquence (FSKey) de sortie entre la phase ou la fréquence porteuse et la phase ou la fréquence alternative est déterminée par la vitesse BPSK (**BPSK:INTERNAL:RATE**) ou FSK (**FSKey:INTERNAL:RATE**).
- Une voie ne peut pas être sa propre source de modulation.

## Voir également

**INPut:ATTenuation[:STATe]**

**Sous-système AM**

Sous-système BPSK

Sous-système FM

Sous-système FSKey

Sous-système PM

Sous-système PWM



[SOURCE[1|2]:]AM:STATe {ON|1|OFF|0}  
[SOURCE[1|2]:]AM:STATe?

[SOURCE[1|2]:]BPSK:STATe {ON|1|OFF|0}  
[SOURCE[1|2]:]BPSK:STATe?

[SOURCE[1|2]:]FM:STATe {ON|1|OFF|0}  
[SOURCE[1|2]:]FM:STATe?

[SOURCE[1|2]:]FSKey:STATe {ON|1|OFF|0}  
[SOURCE[1|2]:]FSKey:STATe?

[SOURCE[1|2]:]PM:STATe {ON|1|OFF|0}  
[SOURCE[1|2]:]PM:STATe?

[SOURCE[1|2]:]PWM:STATe {ON|1|OFF|0}  
[SOURCE[1|2]:]PWM:STATe?

Active ou désactive la modulation.

Paramètre	Renvoi type
{ON 1 OFF 0}, OFF par défaut	0 (OFF) ou 1 (ON)
Activer la modulation AM (peut également être FM, BPSK, FSK, PM ou PWM) : AM:STAT ON	

- Pour éviter plusieurs modifications des signaux, activez la modulation après avoir configuré les autres paramètres de modulation.
- Vous ne pouvez activer qu'un seul mode de modulation à la fois.
- L'instrument n'active pas la modulation lorsque le mode balayage ou rafale est activé. Lorsque vous activez la modulation, le mode balayage ou rafale est désactivé.
- La modulation PWM est autorisée uniquement lorsque la fonction d'impulsion est sélectionnée.

#### Voir également

[Sous-système AM](#)

[Sous-système BPSK](#)

[Sous-système FM](#)

[Sous-système FSKey](#)

[Sous-système PM](#)

[Sous-système PWM](#)

## Sous-système BURSt

Cette section décrit le sous-système BURSt.

### Exemple

Vous trouverez ci-dessous un récapitulatif des opérations nécessaires à la génération d'une rafale.

1. **Configurez la rafale** : Utilisez la commande **APPLY** ou les commandes équivalentes **FUNCTION**, **FREQUENCY**, **VOLTage** et **VOLTage:OFFSet** pour sélectionner la fonction, la fréquence, l'amplitude et la tension résiduelle du signal. Vous pouvez sélectionner un signal sinusoïdal, carré, triangulaire, PRBS, une rampe, un train d'impulsions ou un signal arbitraire (le bruit est autorisé uniquement en mode rafale commandée ; le courant continu n'est pas autorisé). Pour les rafales déclenchées en interne, la fréquence minimale est de 2,001 MHz. Pour les signaux sinusoïdaux et carrés, les fréquences supérieures à 6 MHz sont autorisées uniquement avec un nombre de cycles de rafale « infini ».
2. **Sélectionnez le mode de rafale « déclenchée » ou « commandée »** : Sélectionnez le mode rafale déclenchée (« N Cycle » sur la face avant) ou le mode rafale commandée à l'aide de la commande **BURSt:MODE**. Si vous utilisez le mode commandé, spécifiez la logique positive ou négative à l'aide de la commande **BURSt:GATE:POLarity**.
3. **Configurez le nombre de rafales** : Définissez le nombre de rafales (nombre de cycles par rafale) à une valeur comprise entre 1 et 100 000 000 cycles (ou infini) avec la commande **BURSt:NCYCles**. Utilisé uniquement en mode rafale déclenchée. En mode PRBS, **BURSt:NCYCles** définit le nombre de bits de la séquence binaire pseudo aléatoire (PRBS). Chaque rafale commence au début de la séquence.
4. **Définissez la période de rafale** : Définissez la période de rafale (intervalle de génération des rafales déclenchées en interne) à une valeur comprise entre 1  $\mu$ s et 8 000 secondes à l'aide de la commande **BURSt:INTernal:PERiod**. Utilisé uniquement en mode rafale déclenchée avec une source de déclenchement interne.
5. **Définissez la phase initiale de la rafale** : Définissez la phase initiale de la rafale à une valeur comprise entre -360 et +360 degrés à l'aide de la commande **BURSt:PHASe**.
6. **Sélectionnez la source de déclenchement** : Sélectionnez la source de déclenchement avec la commande **TRIGger[1|2]:SOURce**. Utilisé uniquement en mode rafale déclenchée.
7. **Activez le mode rafale** : Après avoir configuré les autres paramètres de la rafale, activez le mode rafale (**BURSt:STATe ON**).

Le code suivant produit l'image d'oscilloscope illustrée ci-dessous.

```
APPLY:SIN 1e5,3 VPP,0  
BURS:MODE TRIG  
BURS:NCYC 3  
BURS:INT:PER 4,4e-5  
BURS:PHAS 0  
TRIG:SOUR IMM  
BURS:STAT ON  
OUTP 1
```

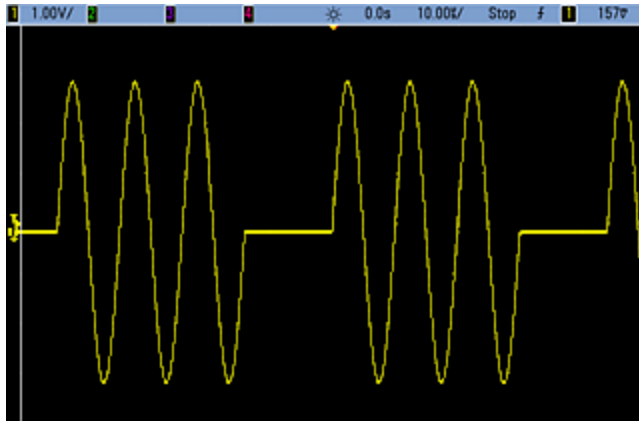

## Modes rafale

Il existe deux modes rafale, décrits ci-dessous. L'instrument active un seul mode rafale à la fois.

- **Mode rafale commandée (par défaut)** : L'instrument envoie un signal pendant un nombre spécifié de cycles (nombre de salves) chaque fois que le signal déclencheur est reçu. Après avoir envoyé ce nombre de cycles, l'instrument s'arrête et attend le déclenchement suivant. Vous pouvez configurer l'instrument afin qu'il utilise un signal déclencheur interne pour démarrer la rafale. Vous pouvez également effectuer un déclenchement externe en appuyant sur la touche **[Trigger]** de la face avant, en appliquant le signal déclencheur sur le connecteur **Ext Trig** de la face arrière ou en envoyant une commande de déclenchement logicielle à partir de l'interface distante.
- **Mode rafale commandée externe** : La sortie de l'instrument est active ou inactive en fonction du niveau du signal externe appliqué sur le connecteur **Ext Trig** de la face arrière. Si ce signal est vrai, l'instrument envoie un signal continu. S'il est faux, le cycle en cours se termine, puis l'instrument s'arrête et sa tension demeure au niveau correspondant à la phase de rafale initiale du signal sélectionné.

Le tableau suivant présente les modes associés aux fonctions de rafale.

	<b>Mode rafale</b> BURSt:MO- DE	<b>Nombre de rafales</b> BURSt:NCYCL- es	<b>Période de la rafale</b> BURSt:INTer- nal:PERiod	<b>Phase de rafale</b> BURSt:PHA- Se	<b>Source de déclen- chement</b> TRIGger [1 2]:SOURce
<b>Mode rafale commandée</b> : Déclen- chement interne	TRIGgered	Disponible	Disponible	Disponible	IMMediate
<b>Mode rafale commandée</b> : Déclen- chement externe	TRIGgered	Disponible	Non utilisé	Disponible	EXTernal, BUS
<b>Mode rafale commandée</b> : Déclen- chement externe	GATed	Non utilisé	Non utilisé	Disponible	Non utilisé

La différence entre la rafale commandée et la sortie commandée est que la rafale commandée commence et s'arrête d'après les cycles du signal, alors que la sortie commandée active et désactive l'instrument avec un déclencheur externe, indépendamment de la phase du signal.

**REMARQUE** Si le rapport cyclique est modifié sur un signal carré déclenché en rafale avec le mode de déclenchement réglé sur Temporisé, la rafale en cours se termine et une nouvelle rafale est exécutée avant que le rapport cyclique de la rafale change.

[SOURCE[1|2]:]BURSt:GATE:POLarity {NORMAL|INVERTed}  
 [SOURCE[1|2]:]BURSt:GATE:POLarity?

Sélectionne la logique positive (NORMAL) ou négative (INVERTed) sur le connecteur **Ext Trig** de la face arrière pour une rafale commandée en externe.

Paramètre	Renvoi type
{NORMAL INVERTed}, NORMAL par défaut	NORM ou INV
Sélectionner la logique positive pour une rafale commandée en externe : BURS:GATE:POL INV	

[SOURCE[1|2]:]BURSt:INTernal:PERiod {<secondes>|MINimum|MAXimum}  
 [SOURCE[1|2]:]BURSt:INTernal:PERiod? [{MINimum|MAXimum}]

Définit la période de rafale pour des rafales déclenchées en interne.

Paramètre	Renvoi type
1 µs à 8 000 s, 10 ms par défaut	+1.2000000000000000E+01
Règle la période de rafale sur 12 secondes : BURS:INT:PER 12	

- La période de la rafale est le temps entre les démarrages de rafales consécutives.
- Utilisée uniquement lorsque le déclenchement immédiat (IMMEDIATE) est activé (TRIGGER[1|2]:SOURCE IMMEDIATE). Ignorée lorsque le déclenchement manuel ou externe est activé (ou en mode rafale commandée).
- Sur la série 33500, la période de rafale doit être calculée à l'aide de la formule suivante :

$$\text{Période rafale} \geq (\text{Nbre cycles} / \text{Fréquence du signal}) + 1 \mu\text{s}.$$

Sur la série 33600, la période de rafale doit être calculée à l'aide de la formule suivante :

$$\text{Période rafale} \geq (\text{Nbre cycles} / \text{Fréquence du signal}) + 500 \text{ ns}, \text{ avec une période de rafale minimale de } 1 \mu\text{s}.$$

- Si la période de rafale est trop faible, l'instrument l'augmente afin de déclencher à nouveau la rafale de façon continue. Sur l'interface distante, l'erreur « Settings conflict » est également générée.

[SOURCE[1|2]:]BURSt:MODE {TRIGgered|GATed}  
[SOURCE[1|2]:]BURSt:MODE?

Sélectionne le mode rafale.

Paramètre	Renvoi type
{TRIGgered GATed}, TRIGgered par défaut	TRIG ou GAT
Configurer le mode rafale commandée : BURSt:MODE GATED	

- TRIGgered : l'instrument envoie un signal pendant un nombre spécifié de cycles (nombre de salves) chaque fois qu'un signal déclencheur est reçu de la source de déclenchement (TRIGger[1|2]:SOURCE).
- En mode de rafale commandée (GATed), le signal de sortie est actif ou inactif en fonction du signal sur le connecteur **Ext Trig** de la face arrière. Sélectionnez la polarité de ce signal à l'aide de la commande **BURSt:GATE:POLarity**. Lorsque le signal de commande est vrai, l'instrument envoie un signal continu. Si le signal de commande est faux, le cycle en cours se termine, puis l'instrument s'arrête et sa tension demeure au niveau correspondant à la phase de rafale initiale du signal. Pour un signal de bruit, la sortie s'arrête immédiatement lorsque le signal de commande devient faux.
- GATed : le nombre de rafales, la période de la rafale et la source de déclenchement sont ignorés (utilisés uniquement en mode rafale déclenchée). Si un signal de déclenchement manuel est reçu TRIGger[1|2]), il est ignoré ; aucune erreur n'est générée.

[SOURCE[1|2]:]BURSt:NCYCles {<num\_cycles>|INFinity|MINimum|MAXimum}  
 [SOURCE[1|2]:]BURSt:NCYCles? [{MINimum|MAXimum}]

Définit le nombre de cycles à envoyer à la sortie pour chaque rafale (uniquement en mode rafale déclenchée).

Paramètre	Renvoi type
Nombre entier compris entre 1 (par défaut) et 100 000 000, limité comme décrit ci-dessous	+5,000000000000000E+01
Renvoyer le nombre de cycles par rafale : BURS:NCYC 50	

- Avec la commande TRIGger[1|2]:SOURce IMMEDIATE, le nombre de cycles doit être inférieur au produit de la période maximale de la rafale (8 000 s) et de la fréquence du signal, comme indiqué ci-dessous.

Nombre de cycles < (Période maximale de la rafale) (Fréquence du signal)

- Augmentez ensuite la période de la rafale jusqu'à sa valeur maximale pour prendre en charge le nombre de cycles (mais la fréquence du signal ne change pas). Sur l'interface distante, l'erreur « Settings conflict » est également générée.
- En mode rafale commandée, le nombre de cycles est ignoré. Cependant, si vous modifiez le nombre de rafales en mode commandé, l'instrument conserve le nouveau nombre et l'utilise lorsque le mode déclenché est sélectionné.

[SOURce[1|2]:]BURSt:PHASe {<angle>|MINimum|MAXimum}  
[SOURce[1|2]:]BURSt:PHASe? [{MINimum|MAXimum}]

Définit l'angle de phase initial de la rafale.

Paramètre	Renvoi type
-360 à +360 degrés, $-2\pi$ à $+2\pi$ radians, ou -(période) à +(période), comme indiqué par la commande <b>UNIT:ANGLE</b> . Par défaut, 0.	+6,0000000000000E+01
Régler la phase de rafale initiale sur 60 degrés : UNIT:ANGLE DEG BURS:PHAS 60	

- Notez que la commande BURSt:PHASe est utilisée à la place de la phase en sortie ; lorsque la rafale est activée, la phase en sortie est nulle (0).
- Pour les signaux sinusoïdaux, carrés et les rampes, 0 degré est le point auquel le signal traverse la tension de 0 V (ou la tension résiduelle CC) dans le sens positif. Pour les signaux arbitraires, 0 degré est le premier point du signal. La phase initiale n'a pas d'effet sur le bruit.
- Pour les signaux arbitraires sur la série 33500, la commande BURSt:PHASe est uniquement disponible si le signal comporte moins de 1 000 000 points.
- Phase initiale également utilisée en mode rafale commandée. Lorsque le signal de commande devient faux, le cycle du signal actif se termine et la sortie demeure au niveau de tension de la phase de rafale initiale.

[SOURce[1|2]:]BURSt:STATe {ON|1|OFF|0}  
[SOURce[1|2]:]BURSt:STATe?

Active ou désactive le mode rafale.

Paramètre	Renvoi type
{ON 1 OFF 0}, OFF par défaut	0 (OFF) ou 1 (ON)
Activer le mode rafale : BURS:STAT ON	

- La phase en sortie est nulle (0) lorsque la rafale est activée.
- Pour éviter plusieurs modifications des signaux, activez le mode rafale après avoir configuré les autres paramètres de la rafale.
- L'instrument n'autorise pas l'activation du mode rafale lorsque le mode balayage ou un mode de modulation est activé. Lorsque vous activez la rafale, le mode balayage ou modulation est désactivé.

## Sous-système CALibration

Le sous-système CALibration s'utilise pour étalonner l'instrument.



## Commandes et requêtes

CALibration[:ALL]?

CALibration:COUNT?

CALibration:SECure:CODE <nouveau\_code>

CALibration:SECure:STATe {ON|1|OFF|0} [, <code>]

CALibration:SECure:STATe?

CALibration:SETup <étape>

CALibration:SETup?

CALibration:STORe

CALibration:STRing "<chaîne de caractères>"

CALibration:STRing?

CALibration:VALue <valeur>

CALibration:VALue?

### CALibration[:ALL]?

Effectue l'étalonnage à l'aide de la valeur d'étalonnage (CALibration:VALue). L'instrument doit être déverrouillé (CALibration\_SECure\_STATe OFF, <code>) pour l'étalonnage.

Paramètre	Renvoi type
(aucun)	+0 (réussite) ou +1 (échec)
Étalonnage avec la valeur active : CAL?	

- La commande CALibration:SETup doit toujours précéder la requête CALibration?.
- Incrémente le nombre d'étalonnages de l'instrument (CALibration:COUNT?).
- Modifie la version volatile des constantes d'étalonnage. Utilisez la commande CALibration:STORe pour enregistrer ces constantes en mémoire non volatile à la fin de l'étalonnage.

## CALibration:COUNT?

Renvoie le nombre d'étalonnages effectués. Lisez et notez le nombre initial lorsque vous recevez l'instrument de l'usine.

Paramètre	Renvoi type
(aucun)	+117
Renvoyer le nombre de points d'étalonnage : CAL:COUNT?	

- Comme cette valeur augmente d'une unité à chaque étalonnage (chaque commande **CALibration:ALL?**), un étalonnage complet l'augmente considérablement.
- Vous pouvez afficher cette valeur, que la sécurité de l'instrument soit ou non verrouillée.
- Ce paramètre est non volatile ; il n'est pas modifié par une remise sous tension ou l'exécution de la commande **\*RST**.

## CALibration:SECure:CODE <nouveau\_code>

Configure le code de sécurité afin d'interdire les étalonnages non autorisés.

Paramètre	Renvoi type
Chaîne de 12 caractères maximum sans guillemets Doit commencer par une lettre (A-Z) Peut contenir des lettres, des chiffres (0 à 9) et le caractère de soulignement	(aucun)
Définir le nouveau code de sécurité : CAL:SEC:CODE MY_CODE_272	

- Les codes de sécurité par défaut configurés en usine varient selon le modèle :

Modèles	Code de sécurité
33521A et 33522A	AT33520A
335XXB	AT33500
Série 33600	AT33600

- Pour modifier le code : déverrouillez la mémoire d'étalonnage avec l'ancien code, puis définissez le nouveau code.
- En cas d'oubli du code de sécurité, reportez-vous à la section **Déverrouillage de l'instrument sans code de sécurité**.
- Ce paramètre est non volatile ; il n'est pas modifié par une remise sous tension ou l'exécution de la commande **\*RST**.

**CALibration:SECure:STATe {ON|1|OFF|0} [,<code>]**

**CALibration:SECure:STATe?**

Active ou désactive la sécurité de l'instrument pour l'étalonnage. Pour étalonner l'instrument, vous devez le déverrouiller avec le code (**CALibration:SECure:CODE**).

Paramètre	Renvoi type
{ON 1 OFF 0}, ON par défaut <code> est une chaîne de 12 caractères maximum sans guillemets	0 (OFF) ou 1 (ON)
Déverrouiller la sécurité d'étalonnage : CAL:SEC:STAT OFF,MY_CODE_272 Verrouiller la sécurité d'étalonnage : CAL:SEC:STAT ON	

- Le <code> est facultatif pour verrouiller la sécurité de l'instrument ; néanmoins, il doit être correct s'il est fourni.
- L'étalonnage sur la face avant ou à partir de l'interface distante doit utiliser le même code. Si vous verrouillez l'instrument à partir d'une interface, vous devez utiliser ce même code pour le déverrouiller à partir de l'autre interface.
- Ce paramètre est non volatile ; il n'est pas modifié par une remise sous tension ou l'exécution de la commande **\*RST**.

**CALibration:SETup <étape>**

**CALibration:SETup?**

Configure l'opération d'étalonnage (1 par défaut) à effectuer. L'instrument doit être déverrouillé (**CALibration:SECure:STATe OFF,<code>**) pour l'étalonnage. Pour plus d'informations, reportez-vous à la section **Sécurité de l'étalonnage**.

Paramètre	Renvoi type
Nombre entier, 1 par défaut	+16
Préparer l'opération d'étalonnage 5 : CAL:SET 5	

- Ce paramètre est non volatile ; il n'est pas modifié par une remise sous tension ou l'exécution de la commande **\*RST**.

## CALibration:STORe

Prélève les constantes d'étalonnage en mémoire volatile (CALibration:ALL?) et les place en mémoire non volatile, où elles ne seront pas modifiées par une remise sous tension de l'instrument ou l'exécution de la commande \*RST. Effectuez cette opération à la fin de l'étalonnage afin d'éviter de perdre les modifications.

Paramètre	Renvoi type
(aucun)	(aucun)
Enregistrer les constantes d'étalonnage en mémoire non volatile : CAL:STOR	

## CALibration:STRing "<chaîne de caractères>"

### CALibration:STRing?

Enregistre un message comportant jusqu'à 40 caractères dans la mémoire d'étalonnage. Les messages courants comprennent la date d'étalonnage, la date d'étalonnage prévue ou les coordonnées du service d'étalonnage. L'instrument doit être déverrouillé (CALibration\_SEcure\_STATe OFF, <code>) pour enregistrer cette chaîne de caractères.

Paramètre	Renvoi type
Chaîne de 40 caractères maximum entre guillemets Peut contenir des lettres, des nombres, des espaces et d'autres caractères courants.	"LAST CAL OCT 31 2011, DUE OCT 31 2012" (Si aucune chaîne de caractères n'est enregistrée, renvoie "")
CAL:STR "FOR CAL HELP, CALL JOE AT EXT 1234"	

- Peut être enregistrée uniquement à partir de l'interface distante avec l'instrument déverrouillé (CALibration:SECure:STATe OFF).
- Vous pouvez lire le message d'étalonnage sur la face avant ou à partir de l'interface distante, que l'instrument soit ou non verrouillé.
- L'enregistrement d'un message d'étalonnage remplace le message précédent.
- Ce paramètre est non volatile ; il n'est pas modifié par une remise sous tension ou l'exécution de la commande \*RST.

**CALibration:VALue <valeur>**

**CALibration:VALue?**

Spécifie la valeur du signal d'étalonnage connu.

Paramètre	Renvoi type
Numérique, 0,0 par défaut	+2,37000000E-002
Spécifier la valeur d'étalonnage 0,0237 : CAL:VAL 2,37E-2	

- Ce paramètre est non volatile ; il n'est pas modifié par une remise sous tension ou l'exécution de la commande **\*RST**.

[SOURce[1|2]:]COMBine:FEED {CH1|CH2|NONE}  
[SOURce[1|2]:]COMBine:FEED?

Active/désactive l'association des sorties des deux voies d'un instrument 2 voies sur le connecteur d'une voie. Le mot clé « SOURce » (SOURce1 par défaut) spécifie la voie de base et <source> indique la voie à associer à la voie de base.

Paramètre	Renvoi type
{CH1 CH2 NONE}, NONE par défaut	CH1, CH2 ou NONE
Définir la source COMBine:FEED de la voie de base 1 comme voie 2 : COMB:FEED CH2	

- La commande COMBine:FEED permet d'ajouter les deux voies pour créer le signal sur la sortie du convertisseur N/A de la voie de base.
- Une seule voie à la fois peut fonctionner en mode COMBine:FEED.
- À la différence des commandes Modulation et **SUM**, la commande COMBine:FEED peut ajouter deux signaux modulés.
- La commande COMBine:FEED peut générer des signaux modulés en quadrature à partir des deux voies ajoutées dans un connecteur unique.
- Pour utiliser la commande COMBine:FEED, configurez d'abord tous les paramètres de chaque voie.
- Les signaux à associer peuvent avoir un déphasage constant entre les voies.
- Vous pouvez utiliser la commande COMBine:FEED pour ajouter du bruit d'une deuxième voie à un signal modulé sur la voie de base.
- Si la sortie associée générée par la commande COMBine:FEED dépasse les caractéristiques nominales de l'instrument ou des limites programmées, l'instrument définit l'option COMBine:FEED sur NONE et envoie une erreur de conflit de paramètres.
- Les signaux sont associés sous forme numérique. Lorsque deux signaux d'amplitude considérablement différents sont associés, la résolution du signal de plus faible amplitude peut être réduite proportionnellement au rapport entre les deux amplitudes.
- La modification de l'amplitude de la fonction ou de la somme de la voie principale ou associée n'entraîne pas la modification de l'amplitude ou de la tension résiduelle d'une autre fonction ou voie. Si la modification de l'amplitude de la somme ou de la fonction de la voie principale ou associée entraîne le dépassement des caractéristiques nominales ou des limites programmées, l'amplitude est écrêtée ; une erreur de conflit de paramètres est signalée.
- La modification de la tension résiduelle de la voie principale ou associée n'a aucune incidence sur l'amplitude ou la tension résiduelle d'une autre fonction ou voie. Si la modification de la tension résiduelle de la voie principale ou associée entraîne le dépassement des caractéristiques nominales ou des limites programmées, l'amplitude est écrêtée ; l'instrument signale une erreur de conflit de paramètres.

- Si l'activation des limites ou le réglage de limites programmées implique qu'une limite est inférieure au signal minimal, les limites ne sont pas activées ou réglées ; l'instrument signale une erreur de conflit de paramètres.

## Sous-système DATA

Le sous-système DATA gère les signaux arbitraires personnalisés :

- [SOURCE[1|2]:]DATA:ARbitrary2:FORMat {AABB|ABAB} - spécifie l'ordre des octets dans un fichier de signal arbitraire double (requiert le lecteur IQ en option).
- [SOURCE[1|2]:]DATA:ARbitrary[1|2] <nom\_signal\_arb>, {<bloc\_binaire>|<valeur>, <valeur>, ...} - télécharge des valeurs normalisées de signaux arbitraires dans la mémoire des signaux
- [SOURCE[1|2]:]DATA:ARbitrary[1|2]:DAC <nom\_signal\_arb>, {<bloc\_binaire>|<valeur>, <valeur>, ...} - télécharge des codes de convertisseur N/A de signaux arbitraires dans la mémoire des signaux
- [SOURCE[1|2]:]DATA:ATTRibute:AVERage? [<nom\_signal\_arb>] - renvoie la moyenne arithmétique de toutes les valeurs des points d'un signal arbitraire ou d'une séquence
- [SOURCE[1|2]:]DATA:ATTRibute:CFACTOR? [<nom\_signal\_arb>]ATA:ATTRibute:CFACTOR? - renvoie le facteur de crête de toutes les valeurs des points d'un signal arbitraire ou d'une séquence
- [SOURCE[1|2]:]DATA:ATTRibute:POINTS? [<nom\_signal\_arb>] - renvoie le nombre de valeurs des points d'un signal arbitraire ou d'une séquence
- [SOURCE[1|2]:]DATA:ATTRibute:PTPeak? [<nom\_signal\_arb>] - renvoie la valeur crête à crête de toutes les valeurs des points d'un signal arbitraire ou d'une séquence
- [SOURCE[1|2]:]DATA:SEquence <descripteur\_bloc> - combine des signaux arbitraires précédemment chargés dans une séquence
- [SOURCE[1|2]:]DATA:VOLatile:CATalog? - renvoie le contenu de la mémoire volatile des signaux, y compris les signaux arbitraires et les séquences
- [SOURCE[1|2]:]DATA:VOLatile:CLEar - efface la mémoire volatile des signaux
- [SOURCE[1|2]:]DATA:VOLatile:FREE? - renvoie le nombre de points disponibles (libres) en mémoire volatile

## Exemples

L'exemple suivant utilise des commandes DATA pour configurer une séquence de signaux arbitraires.

**REMARQUE** La commande DATA:SEquence illustrée ci-dessous est un exemple de bloc de longueur définie. La partie « #3 » au début de la chaîne indique que les trois chiffres suivants afficheront le nombre de caractères contenus dans le bloc. La partie « 164 » immédiatement après indique que la chaîne comprend 164 caractères dans la chaîne qui suit.

Notez que la commande DATA:SEquence longue est répartie sur plusieurs lignes pour une meilleure lisibilité.

Notez également que les guillemets utilisés dans la commande DATA:SEquence sont facultatifs.

```
*CLS
*RST

MMEM:LOAD:DATA "INT:\BUILTIN\HAVERSINE.arb"
MMEM:LOAD:DATA "INT:\BUILTIN\CARDIAC.arb"
MMEM:LOAD:DATA "INT:\BUILTIN\GAUSSIAN.arb"

DATA:SEquence #3164"-
testSeq", "INT:\BUILTIN\HAVERSINE.arb",0,repeat,highAtStartGoLow,30,
"INT:\BUILTIN\CARDIAC.arb",0,repeat,maintain,10,
"INT:\BUILTIN\GAUSSIAN.arb",0,repeat,maintain,10
FUNC:ARB "testSeq"

FUNC ARB
OUTPUT1 ON
```

Cette séquence exécute le signal demi-sinus inverse (Haversine) à 30 reprises, puis les signaux cardiaques et gaussiens 10 fois chacun. Le signal Haversine force la position haute du marqueur au début de chaque séquence, puis le met en position basse au point du marqueur. Les deux autres signaux conservent le réglage du marqueur.



### Format de <nom\_signal\_arb>

De nombreuses commandes DATA utilisent le nom d'un signal arbitraire. Les règles suivantes s'appliquent :

- <nom\_signal\_arb> doit correspondre à :
  - Un signal déjà chargé dans la mémoire des signaux
  - Un signal existant dans la mémoire de masse interne (INTERNAL) ou USB
- Pour plus d'informations sur les formats de noms valides pour <nom\_signal\_arb>, reportez-vous aux commandes **MMEMory:LOAD:DATA[1|2]**, **DATA:ARBitrary** ou **DATA:ARBitrary:DAC**.

### [SOURce[1|2]:]DATA:ARBitrary2:FORMat {AABB|ABAB}

(S'applique uniquement aux instruments dotés de la fonction de lecteur IQ en option.)

Indique si le format des points de données dans les commandes **DATA:ARB2** et **DATA:ARB2:DAC** est entrelacé (ABAB) ou si toutes les valeurs de la voie 1 sont suivies par celles de la voie 2 (AABB).

**REMARQUE** Vous pouvez écrire le mot clé ARBitrary2, mais vous devez l'abrégier sous la forme ARB2. Vous ne pouvez pas utiliser l'abréviation ARB.

Paramètre	Renvoi type
{AABB ABAB}	AABB ou ABAB
Spécifier le format entrelacé pour les données des signaux arbitraires : DATA:ARB2:FORM ABAB	

- Le mot clé SOURce est ignoré dans cette commande.
- Si vous souhaitez avoir un signal 3 de convertisseur N/A sur la voie 1 et un signal 4 de convertisseur N/A sur la voie 2, le format AABB impose que les données soient envoyées dans l'ordre 3, 3, 3, 3, 3, 3, 3, 3, 4, 4, 4, 4, 4, 4, 4, 4. Le format ABAB imposerait l'ordre 3, 4, 3, 4, 3, 4, 3, 4, 3, 4, 3, 4, 3, 4, 3, 4.

[SOURCE[1|2]:]DATA:ARbitrary[1|2] <nom\_signal\_arb>, {<bloc\_binaire>|<valeur>, <valeur>, ...}

[SOURCE[1|2]:]DATA:ARbitrary[1|2]:DAC <nom\_signal\_arb>, {<bloc\_binaire>|<valeur>, <valeur>, ...}

Télécharge des nombres entiers représentant les codes des convertisseurs N/A (DATA:ARbitrary[1|2]:DAC) ou des valeurs à virgule flottante (DATA:ARbitrary[1|2]) dans la mémoire volatile des signaux sous forme d'une liste séparée par des virgules ou d'un ensemble binaire de données. Les codes du convertisseur numérique/analogique sont compris entre -32,768 et +32,767 sur les séries 33500 et 33600.

**REMARQUE**

L'option [1|2] après le mot clé ARbitrary indique si les données doivent à télécharger contiennent une (par défaut) ou deux voies de données.

Pour utiliser des fichiers de signaux arbitraires doubles (fichiers contenant deux voies de données de signaux arbitraires), vous devez disposer du **lecteur IQ en option**.

Paramètre	Renvoi type
<nom_signal_arb> Chaîne sans guillemets contenant jusqu'à 12 caractères.	(aucun)
<bloc_binaire> nombres entiers compris entre -32 767 et +32 767 ou valeurs à virgule flottante comprises entre -1,0 et +1,0 au format de bloc arbitraire de taille définie (détails ci-dessous). De 8 à 1 millions ou 16 millions échantillons par signal, <b>en fonction du modèle et des options</b> .  Les données en bloc de longueur définie permettent de transmettre les données dépendant d'un appareil sous forme d'un ensemble de données binaires sur 8 bits. Cela est particulièrement utile pour transférer des quantités importantes de données ou des codes étendus sur 8 bits.	
<valeur> liste séparée par des virgules de nombres entiers compris entre -32 767 et +32 767 ou de valeurs à virgule flottante comprises entre -1,0 et +1,0. De 8 à 65 536 points.	

Paramètre	Renvoi type
Télécharger une liste de 9 valeurs du signal séparées par des virgules dans la mémoire des signaux : DATA:ARB:DAC myArb, 32767, 24576, 16384, 8192, 0, -8192, -16384, -24576, -32767	
Téléchargez 9 points de signal dans la mémoire des signaux sous forme de bloc binaire. Le paramètre <PMT> spécifie la fin des données binaires. Il peut s'agir du caractère de saut de ligne ou le dernier octet de vos données binaires peut déclarer le message EOI (End ou Identify). DATA:ARB myArb, #236<36 bytes of your_binary_data><PMT>	
Télécharger une liste de 9 valeurs du signal séparées par des virgules dans la mémoire des signaux : DATA:ARB myArb, 1, .75, .50, .25, 0, -.25, -.50, -.75, -1	
Téléchargez 8 points d'un double signal arbitraire dans la mémoire des signaux sous forme d'une liste séparée par des virgules de codes de convertisseur N/A. Il existe au total 16 valeurs, à raison de 8 pour chacune des deux voies. Notez que les données sont entrelacées (ABAB). Les valeurs positives se trouvent donc sur la voie 1 et les valeurs négatives sur la voie 2 : DATA:ARB2:FORM ABAB DATA:ARB2:DAC myArb, 30000, -10000, 29000, -9000, 27000, -7000, 24000, -4000, 27000, -7000, 29000, -9000, 30000, -10000, 29000, -9000	
Télécharger les mêmes exemples que ci-dessus, mais au format AABB : DATA:ARB2:FORM AABB DATA:ARB2:DAC myArb, 30000, 29000, 27000, 24000, 27000, 29000, 30000, 29000, -10000, -9000, -7000, -4000, -7000, -9000, -10000, -9000	

- Chaque valeur d'un point est un entier sur 16 bits compris entre -32 767 et +32 767 ou une valeur 32 bits à virgule flottante comprise entre -1,0 et +1,0. Le nombre total d'octets nécessaire est donc égal à deux ou quatre fois le nombre de valeurs des points du signal. Par exemple, 16 000 octets sont nécessaires pour télécharger un signal de 8 000 sous forme d'entiers, mais 32 000 octets sont nécessaires pour télécharger le même signal sous forme de valeurs à virgule flottante.
- Les valeurs -32 767 et +32 767 ou -1,0 à +1,0 correspondent aux valeurs de crête du signal (si la tension résiduelle est égale à 0 V). Par exemple, si vous définissez l'amplitude de sortie à 10 Vpp, +32 767 correspond à +5 V et -32 767 à -5 V.
- Utilisez la commande **FORMat:BORDER** pour sélectionner l'ordre des octets pour les transferts de blocs de données binaires.
- Utilisez la commande **DATA:ARB2:FORMat** pour indiquer si des signaux arbitraires doubles sont entrelacés ou séquentiels (voie 1 suivie de la voie 2).
- La spécification d'un signal déjà chargé génère l'erreur « Specified arb waveform already exists ». Pour supprimer un signal existant, vous devez effacer toute la mémoire des signaux à l'aide de la commande **DATA:VOLatile:CLEar**.
- La taille totale des échantillons disponible pour tous les signaux chargés par voie est de 1 M.éch ou 16 de M.éch (série 33500) ou de 4 M.éch ou 64 M.éch (série 33600), **selon le modèle et les options**. Un nouveau signal peut être limité par des signaux déjà chargés.

**REMARQUE** Quelles que soient les options installées, la taille de signal maximale pour l'éditeur de signaux intégré est de 1 Méch.

### [SOURCE[1|2]:]DATA:ATTRIBUTE:AVERAGE? [<nom\_signal\_arb>]

Renvoie la moyenne arithmétique de toutes les valeurs des points en mémoire interne ou USB du signal arbitraire spécifié, ou chargés dans la mémoire des signaux.

Paramètre	Renvoi type
<nom_signal_arb> correspond à un nom de fichier valide. S'il n'est pas fourni, <nom_signal_arb> est le signal arbitraire actif par défaut (sélectionné à l'aide de la commande <b>FUNCTION:ARBITRARY</b> ).	+2,47199927E-002
Renvoyer la moyenne de tous les points enregistrés dans « SINC ». DATA:ATTR:AVER? "INT:\BuiltIn\SINC.arb"	

- La requête d'un signal déjà chargé génère l'erreur « Specified arb waveform does not exist ».
- <nom\_signal\_arb> peut être un nom de fichier (mis en mémoire par la commande **MEMORY:LOAD:DATA[1|2]**) ou un nom généré par les commandes **DATA:ARBITRARY** ou **DATA:ARBITRARY:DAC**.

### [SOURCE[1|2]:]DATA:ATTRIBUTE:CFAC? [<nom\_signal\_arb>]

Renvoie le *facteur de crête* de toutes les valeurs des points du segment du signal arbitraire en mémoire INTERNAL ou USB, ou chargés dans la mémoire des signaux.

Paramètre	Renvoi type
<nom_signal_arb> correspond à un nom de fichier valide. S'il n'est pas fourni, <nom_signal_arb> est le signal arbitraire actif par défaut (sélectionné à l'aide de la commande <b>FUNCTION:ARBITRARY</b> ).	+1,72513640E+000
Renvoyer le facteur de crête de tous les points enregistrés dans « NEG_RAMP ». DATA:ATTR:CFAC? "INT:\BuiltIn\NEG_RAMP.arb"	

- Le facteur de crête est le quotient de la valeur en crête par la valeur efficace du signal.
- La requête d'un signal déjà chargé génère l'erreur « Specified arb waveform does not exist ».
- <nom\_signal\_arb> peut être un nom de fichier (mis en mémoire par la commande **MEMORY:LOAD:DATA[1|2]**) ou un nom généré par les commandes **DATA:ARBITRARY** ou **DATA:ARBITRARY:DAC**.

### [SOURce[1|2]:]DATA:ATTRibute:POINts? [<nom\_signal\_arb>]

Renvoyer le nombre de points dans le segment du signal arbitraire en mémoire INTERNAL ou USB, ou chargés dans la mémoire des signaux.

Paramètre	Renvoi type
<nom_signal_arb> correspond à un nom de fichier valide. S'il n'est pas fourni, <nom_signal_arb> est le signal arbitraire actif par défaut (sélectionné à l'aide de la commande <b>FUNCTION:ARbitrary</b> ).	+250
Renvoyer le nombre de valeurs des points dans « EXP_RISE » : DATA:ATTR:POIN? "INT:\BuiltIn\EXP_RISE.arb"	

- <nom\_signal\_arb> peut être un nom de fichier (mis en mémoire par la commande **MMEMory:LOAD:DATA[1|2]**) ou un nom généré par les commandes **DATA:ARbitrary** ou **DATA:ARbitrary:DAC**.

### [SOURce[1|2]:]DATA:ATTRibute:PTPeak? [<nom\_signal\_arb>]

Calcule la *valeur crête à crête* de toutes les valeurs des points du segment du signal arbitraire en mémoire INTERNAL ou USB, ou chargés dans la mémoire des signaux.

Paramètre	Renvoi type
Tout nom de fichier valide. S'il n'est pas fourni, <nom_signal_arb> est le signal arbitraire actif par défaut (sélectionné à l'aide de la commande <b>FUNCTION:ARbitrary</b> ).	+1,00000000E+000
Renvoyer la valeur crête à crête de « EXP_FALL » : DATA:ATTR:PTP? "INT:\BuiltIn\EXP_FALL.arb"	

- <nom\_signal\_arb> doit correspondre à :
  - Un signal déjà chargé dans la mémoire des signaux
  - Un signal existant dans la mémoire de masse interne (INTERNAL) ou USB
- Pour plus d'informations sur les formats de noms valides pour <nom\_signal\_arb>, reportez-vous aux commandes **MMEMory:LOAD:DATA[1|2]**, **DATA:ARbitrary** ou **DATA:ARbitrary:DAC**.
- Limitations concernant les signaux arbitraires : Pour les signaux arbitraires, l'amplitude est limitée si les points du signal ne couvrent pas toute la plage du convertisseur N/A de sortie. Par exemple, le signal intégré « Sinc » n'utilise pas la plage totale de valeurs ; son amplitude est donc limitée à 6,087 Vpp (dans une charge de 50 Ω).
- <nom\_signal\_arb> peut être un nom de fichier (mis en mémoire par la commande **MMEMory:LOAD:DATA[1|2]**) ou un nom généré par les commandes **DATA:ARbitrary** ou **DATA:ARbitrary:DAC**.

## [SOURce[1|2]:]DATA:SEQUence <descripteur\_bloc>

Définit une séquence de signaux déjà chargés dans la mémoire des signaux via la commande **MMEMory:LOAD:DATA[1|2]** ou **DATA:ARBitrary**. La commande **MMEMory:LOAD:DATA[1|2]** peut également charger un fichier de séquence qui charge automatiquement les signaux arbitraires associés et comprend la configuration de l'amplitude, de la tension résiduelle, de la fréquence d'échantillonnage et des filtres.

Paramètre	Renvoi type
Bloc arbitraire de taille définie IEEE, décrit ci-dessous.	(aucun)
(voir l' <b>exemple</b> )	

- Même les signaux arbitraires comportant des millions de points peuvent être insuffisants pour les applications nécessitant une séquence répétitive spéciale de signaux en fonction du temps et des événements externes. Les séquences de signaux arbitraires permettent de disposer et de reproduire des signaux sous certaines conditions. Cela permet d'utiliser moins de mémoire et de réaliser des applications plus souples et flexibles.

Les données en bloc de longueur définie permettent de transmettre les données dépendant d'un appareil sous forme d'un ensemble de données binaires sur 8 bits. Cela est particulièrement utile pour transférer des quantités importantes de données ou des codes étendus sur 8 bits.

- <descripteur\_bloc> adopte le format suivant : #<n><n chiffres><nom séquence>,<nom signal arb1>,<nombre de répétitions1>,<contrôle de lecture1>,<mode marqueur1>,<point marqueur1>,<nom signal arb2>,<nombre de répétitions2>,<contrôle de lecture2>,<mode marqueur2>,<point marqueur2>,<point marqueur2>, etc., où :
  - <n> indique le nombre de chiffres utilisés pour indiquer la taille du bloc.
  - <n chiffres> indique un ou plusieurs chiffres qui spécifient le nombre d'octets à venir.
  - <nom séquence> est une chaîne de caractères ASCII sans guillemets qui spécifie le nom de la séquence contenant les signaux arbitraires spécifiés dans les paramètres suivants.
  - <nom signal arb> est une chaîne de caractères entre guillemets qui spécifie le nom du signal arbitraire chargé avec la commande **MMEM:LOAD:DATA[1|2]** or **DATA:ARBitrary**.
  - <nombre répétitions> est une chaîne de caractères entre guillemets facultative qui indique le nombre de répétitions du signal. Cette valeur peut être comprise entre 1 et 1E6 ou l'infini. Le matériel reconnaît cette option uniquement si l'option Contrôle de lecture est définie sur Répéter.
  - <contrôle de lecture> est une chaîne de caractères entre guillemets facultative qui indique comment le signal arbitraire doit être lu dans la séquence :
    - **once**- lire une seule fois
    - **onceWaitTrig**- lire une fois, puis attendre un déclenchement. Les déclenchements ne sont pas acceptés tant que la lecture du segment spécifié n'est pas terminée.
    - **repeat**- recommencer le nombre de fois spécifié
    - **repeatInf**- recommencer jusqu'à l'arrêt (infini)

- **repeatTilTrig** - recommencer jusqu'au déclenchement, puis passer à l'étape suivante

**REMARQUE** Pour les petits signaux, plusieurs cycles peuvent être nécessaires après la réception du déclenchement pour passer au signal suivant. Cela est dû au fait que les échantillons contenus dans la mémoire tampon doivent être effacés.

- *<mode marqueur>* est une chaîne de caractères entre guillemets facultative qui indique le comportement du marqueur dans le signal arbitraire :
  - **maintain**- maintient l'état du marqueur actuel au début du segment
  - **lowAtStart**- force la position basse du marqueur au début du segment
  - **highAtStart**- force la position haute du marqueur au début du segment
  - **highAtStartGoLow**- force marker high at start of segment and then low at marker position
- *<point marqueur>* nombre indiquant l'emplacement du marqueur dans le signal arbitraire Cette valeur doit être comprise entre 4 et le nombre de points contenus dans le signal arbitraire moins 3.
- Si vous spécifiez un signal arbitraire qui n'est pas chargé, l'erreur « Specified arb waveform does not exist » est générée.

#### Exemple de commande DATA:SEquence

La commande suivante crée une séquence (baptisée mySequence) de 3 segments (A.arb, B.arb et C.arb) précédemment chargés à partir d'une clé USB avec la commande **MMEMory:LOAD:DATA[1|2]**. Cette séquence lit A une fois et B cinq fois. Elle lit ensuite C en boucle en attendant un déclenchement pour continuer et se termine finalement par A. Le *<point marqueur>* est réglé sur 10.

La commande est représentée sur plusieurs lignes à des fins de lisibilité uniquement.

```
DATA:SEQ #3158"-
mySe-
quen-
ce", "USB:\A.arb", 0, once, lowAtStart, 10, "USB:\B.arb", 5, repeat, highAtStart, 10,
"USB:\C.arb", 0, repeatTilTrig, maintain, 10, "USB:\A.arb", 0, once, lowAtStart, 10
```

De nombreux éditeurs de texte permettent de compter le nombre d'octets dans un bloc en affichant simplement en surbrillance une chaîne de texte. Dans cet exemple, la taille est égale à 158, qui requiert 3 chiffres pour la représenter, d'où l'en-tête #3158.

Cette approche nécessite de précharger tous les signaux arbitraires et de définir l'amplitude et la tension résiduelle (ou les niveaux inférieur et supérieur), la fréquence d'échantillonnage et le filtre. Reportez-vous à la commande **MMEM:LOAD:DATA** pour regrouper toutes ces informations dans un seul fichier plutôt que de créer un transfert en bloc avec plusieurs commandes SCPI.

### [SOURCE[1|2]:]DATA:VOLatile:CATalog?

Revoie le contenu de la mémoire volatile des signaux, y compris les signaux arbitraires et les séquences.

Paramètre	Renvoi type
(aucun)	"INT:\BUILTIN\EXP_RISE.ARB","USB:\XYZ\A.ARB","USB:\XYZ\B.ARB","USB:\xyz\xyz.seq"
Renvoyer le contenu de la mémoire volatile en supposant que les signaux A.arb, B.arb et C.arb ont été précédemment chargés sur la voie 1 via un fichier de séquence sur USB:\xyz\xyz.seq : DATA:VOL:CAT?	

### [SOURCE[1|2]:]DATA:VOLatile:CLEar

Efface la mémoire des signaux de la voie spécifiée et recharge le signal par défaut.

Paramètre	Renvoi type
(aucun)	(aucun)
Effacer le contenu de la mémoire des signaux sur la voie 1 et recharger le signal par défaut : DATA:VOL:CLE	

### [SOURCE[1|2]:]DATA:VOLatile:FREE?

Revoie le nombre de points disponibles (libres) en mémoire volatile. Chaque signal arbitraire chargé en mémoire volatile occupe l'espace affecté à des blocs de 128 points : un signal de 8 à 128 points occupe un tel bloc, un signal de 129 à 256 points occupe deux blocs et ainsi de suite.

L'instrument standard comporte une mémoire pour 1 million de points par voie (série 33500) ou 4 millions de points par voie (série 33600). Vous pouvez également **augmenter la taille de la mémoire à 16 millions (série 33500) ou 64 millions de points (série 33600)**.

Paramètre	Renvoi type
(aucun)	+382956
Renvoyer le nombre d'octets de mémoire volatile disponible : DATA:VOL:FREE?	

## Sous-système DISPLAY

Le sous-système DISPLAY contrôle l'écran de l'instrument.

### Exemple

Le programme suivant active l'écran de l'instrument et affiche un message qui indique de ne pas le toucher.

```
DISP OFF
DISP:TEXT "Test running. Please do not touch."
```



## Commandes

Le sous-système DISPLAY comprend les commandes suivantes.

- **DISPlay {ON|1|OFF|0}** - active/désactive l'écran
- **DISPlay:FOCUS** - sélectionne la voie affichée « à l'avant » d'un instrument 2 voies
- **DISPlay:TEXT "<chaîne de caractères>"** - affiche uniquement les messages textuels à l'écran
- **DISPlay:TEXT:CLEAr** - efface les messages textuels de l'écran
- **DISPlay:UNIT:ARBRate {SRATE|FREQUENCY|PERIOD}** - sélectionne les unités de fréquence des signaux arbitraires
- **DISPlay:UNIT:PULSE {WIDTH|DUTY}** - sélectionne la méthode de spécification des largeurs d'impulsion
- **DISPlay:UNIT:RATE {FREQUENCY|PERIOD}** - sélectionner les unités de fréquence pour les signaux sinusoïdaux, carrés, triangulaires, les impulsions et les rampes
- **DISPlay:UNIT:SWEp {STARTstop|CENTerspan}** - sélectionne la méthode de spécification des plages de balayage
- **DISPlay:UNIT:VOLT {AMPLitudeoff|HIGHlow}** - sélectionne la méthode de spécification des plages de tension
- **DISPlay:VIEW {STANDARD|TEXT|GRAPH|DUAL}** - sélectionne la vue affichée à l'écran

### DISPlay {ON|1|OFF|0}

#### DISPlay?

Active/désactive l'écran de la face avant. Lorsqu'il est désactivé, l'écran de la face avant est noir ; tous les voyants sont éteints. Cependant, l'écran demeure sous tension.

Paramètre	Renvoi type
{ON 1 OFF 0}, ON par défaut	0 (OFF) ou 1 (ON)
Désactiver l'écran : DISP OFF	

- La désactivation de l'écran accélère l'exécution des commandes à partir de l'interface distante et offre une sécurité de base.
- L'envoi de la commande **DISPlay:TEXT <chaîne de caractères>** remplace l'état de l'écran. Vous pouvez afficher un message avec l'écran désactivé.
- L'écran est activé lorsque l'alimentation est coupée puis rétablie ou lorsque vous revenez à l'utilisation locale (sur la face avant) en appuyant sur la touche **[Local]** de la face avant.

## DISPlay:FOCus {CH1|CH2}

Sélectionne la voie qui est affichée « à l'avant » d'un instrument 2 voies.

Paramètre	Renvoi type
{CH1 CH2} Par défaut, CH1	CH1 ou CH2
Amener la voie 2 à l'avant : DISP:FOCus CH2	

## DISPlay:TEXT "<chaîne de caractères>"

### DISPlay:TEXT?

Affiche un message textuel sur l'écran de la face avant.

Paramètre	Renvoi type
Chaîne de caractères entre guillemets contenant jusqu'à 40 caractères, "" par défaut.	"Test running. Do not touch."
Afficher un message à l'écran : DISP:TEXT "Test in progress..."	

- L'envoi de la commande **DISPlay:TEXT <chaîne de caractères>** remplace l'état de l'écran. Vous pouvez afficher un message avec l'écran désactivé.
- Lorsqu'un message est affiché, les informations concernant le fonctionnement de l'instrument ne sont pas envoyées à l'écran de la face avant.
- La commande **\*RST** n'a pas d'influence sur le texte affiché. Ce dernier est effacé à la mise sous tension.

## DISPlay:TEXT:CLEar

Efface le message textuel sur l'écran de la face avant.

Paramètre	Renvoi type
(aucun)	(aucun)
Effacer un message sur l'écran : DISP:TEXT:CLE	

- Avec **DISPlay ON**, DISP:TEXT:CLEar ramène l'écran en mode normal.
- Avec **DISPlay OFF**, DISP:TEXT:CLEar efface le message et l'écran demeure désactivé. Pour activer l'écran, exécutez la commande **DISPplay ON** ou appuyez sur la touche **[Local]** de la face avant.
- La commande **\*RST** n'a pas d'influence sur le texte affiché. Ce dernier est effacé à la mise sous tension.

### DISPlay:UNIT:ARBRate {SRATe|FREQuency|PERiod}

Indique si les unités de fréquence des signaux arbitraires sont des échantillons par seconde, (SRATe), Hz (FREQ) ou des secondes (PER).

Paramètre	Renvoi type
{SRATe FREQuency PERiod} Par défaut, SRATe	SRAT, FREQ ou PER
Définit l'unité des signaux arbitraires en secondes : DISP:UNIT:ARBR PER	

- La fréquence et la période d'un signal arbitraire font référence au temps nécessaire pour parcourir le signal complet en une seule fois. Par exemple, un signal de 200 échantillons fonctionnant à 1 M.éch/s présente une période de 0,0002 s et une fréquence de 5 000 Hz.

### DISPlay:UNIT:PULse {WIDTh|DUTY}

Sélectionne la méthode de spécification de la durée d'impulsion. Vous pouvez spécifier la largeur ou le rapport cyclique.

Paramètre	Renvoi type
{WIDTh DUTY} Par défaut, WIDTh	WIDT ou DUTY
Spécifier la largeur d'impulsion en pourcentage (rapport cyclique) : DISP:UNIT:PULS DUTY	

### DISPlay:UNIT:RATE {FREQuency|PERiod}

Indique si les unités de fréquence des signaux sinusoïdaux, carrés, triangulaires, des impulsions et des rampes sont des Hz (FREQ) ou des secondes (PER).

Paramètre	Renvoi type
{FREQuency PERiod} Par défaut, FREQuency	FREQ ou PER
Définir les unités sur en Hz : DISP:UNIT:RATE FREQ	

### DISPlay:UNIT:SWEep {STARtstop|CENTerspan}

Sélectionne la méthode de spécification de la plage de fréquences de balayage. Vous pouvez spécifier la plage sous forme de valeurs initiale et finale ou de périmètre autour d'une valeur centrale.

Paramètre	Renvoi type
{STARtstop CENTerspan} Par défaut, STARtstop	STAR ou CENT
Les exemples suivants indiquent un balayage compris entre 10 et 500 Hz : DISP:UNIT:SWE STAR FREQ:STAR 10 FREQ:STOP 500  DISP:UNIT:SWE CENT FREQ:SPAN 490 FREQ:CENT 255	

- Pour balayer en fréquences croissantes, définissez une plage de fréquences positives ; pour balayer en fréquences décroissantes, définissez une plage de fréquences négatives.

### DISPlay:UNIT:VOLT {AMPLitudeoff|HIGHlow}

Sélectionne la méthode de spécification des plages de tension. Vous pouvez spécifier une plage de tension en tant qu'amplitude et tension résiduelle, ou sous forme de valeurs haute et basse.

Paramètre	Renvoi type
{AMPLitudeoff HIGHlow} Par défaut : AMPLitudeoff	AMPL ou HIGH
Les exemples suivants indiquent une tension de signal comprise entre 1 et 4 V : DISP:UNIT:VOLT HIGH VOLT:LOW 1 VOLT:HIGH 4  DISP:UNIT:VOLT:AMPL VOLT 3 VOLT OFFS 2,5	

## DISPlay:VIEW {STANdard|TEXT|GRAPh|DUAL}

Sélectionne la disposition de l'écran.

Paramètre	Renvoi type
{STANdard TEXT GRAPh DUAL} Par défaut, STANdard	STAN, TEXT, GRAP ou DUAL
Sélectionner l'affichage graphique large : DISP:VIEW GRAP	

- Les mots clés STANdard, TEXT, GRAPh et DUAL correspondent aux touches de fonction **Standard View**, **Large Text**, **Large Graph** et **CH1/CH2** du menu [System] > System Setup > Screen Layout.

## Sous-système FM

Les opérations nécessaires à la génération d'un signal de modulation de fréquence (FM) sont résumées ci-dessous.

1. **Configurez le signal porteur** : Utilisez les commandes **FUNCtion**, **FREQuency**, **VOLTage** et **VOLTage:OFFSet** pour spécifier la fonction du signal, sa fréquence, son amplitude et sa tension résiduelle.
2. **Sélectionnez la source de modulation (interne, externe, CH1 ou CH2)** : **FM:SOURce**. Pour une source de modulation externe, ignorez les opérations 3 et 4.
3. **Sélectionne le signal modulant** : **FM:INTernal:FUNCtion**
4. **Définissez la fréquence de modulation** : **FM:INTernal:FREQuency**
5. **Définissez la variation de fréquence maximale** : **FM:DEViation**
6. **Activez la modulation de fréquence (FM)** : **FM:STATe:ON**

Le code suivant produit l'image d'oscilloscope illustrée ci-dessous.

```
FUNCTION SQU  
FREQUENCY +4,0E+05  
VOLTAGE +1,0  
VOLTAGE:OFFSET 0,0  
FM:SOURCE INT  
FM:DEVIATION +3,5e5  
FM:INTERNAL:FREQUENCY +5e4  
FM:INTERNAL:FUNCTION RAMP  
FM:STATE 1  
OUTP 1
```

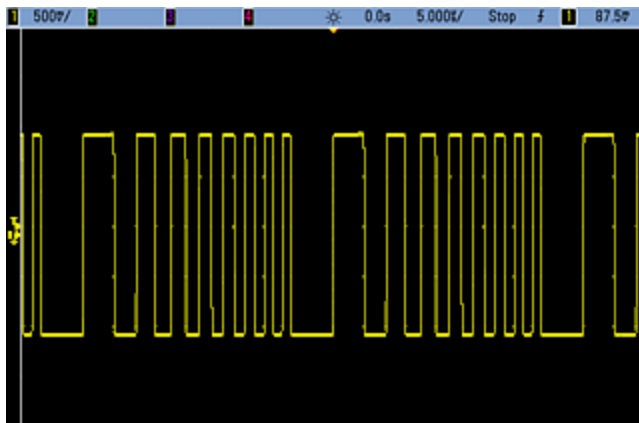

[SOURce[1|2]:]FM[:DEViation] {<variation\_crête\_en\_Hz>|MINimum|MAXimum|DEFAULT}  
[SOURce[1|2]:]FM[:DEViation]? [{MINimum|MAXimum}]

Définissez la variation de fréquence maximale en Hz. Cette valeur représente la variation de fréquence maximale du signal *modulé* par rapport à la fréquence porteuse.

Paramètre	Renvoi type
1 µHz à 15,05 (limité à 150 kHz pour le signal RAMP) ; 100 Hz par défaut	+1,0000000000000000E+03
Définir la variation de fréquence maximale à 1 kHz : FM:DEV 1000  Définir la variation de fréquence maximale à 1 µHz : FM:DEV MIN	

- La variation ne peut être supérieure à la fréquence porteuse. Si vous tentez de définir une variation supérieure à la fréquence porteuse (en mode FM activé), l'instrument ajuste la variation à la valeur maximale autorisée pour cette fréquence. *Sur l'interface distante, l'erreur « Settings conflict » est également générée.*
- La fréquence porteuse augmentée de la variation ne peut pas être supérieure à la fréquence maximale de la fonction sélectionnée plus 100 kHz. Si vous tentez de régler la variation sur une valeur incorrecte, l'instrument l'ajuste à la valeur maximale autorisée avec la fréquence porteuse active. L'interface distante génère également l'erreur « Data out of range ».
- Si en raison de la variation, le signal porteur est à une fréquence supérieure à la limite pour le rapport cyclique actif (signal carré uniquement), l'instrument ajuste le rapport cyclique à la valeur maximale autorisée avec la fréquence porteuse actuelle. *Sur l'interface distante, l'erreur « Settings conflict » est également générée.*
- Si vous sélectionnez la source modulante *externe*, la variation est contrôlée par le signal ±5 V (éventuellement ±1 V sur la série 33600) présent sur le connecteur **Modulation In** de la face arrière. Par exemple, si la variation de fréquence est de 100 kHz, un signal +5 V (éventuellement de +1 V sur la série 33600) correspond à une augmentation de fréquence de 100 kHz. Des signaux externes plus faibles produisent une variation moindre et les signaux négatifs réduisent la fréquence au-dessous de la fréquence porteuse.

[SOURce[1|2]:]FM:INTernal:FREQuency {<fréquence>|MINimum|MAXimum|DEFault}  
[SOURce[1|2]:]FM:INTernal:FREQuency? [{MINimum|MAXimum}]

Définit la fréquence du signal modulant. Le signal utilisé comme source modulante fonctionne à cette fréquence dans les limites de fréquence de ce signal.

Paramètre	Renvoi type
1 µHz à la <b>valeur maximale autorisée pour la fonction interne</b> . Par défaut, 10 Hz	+1,0000000000000000E+04
Réglez la fréquence modulante sur 10 kHz : FM:INT:FREQ 10000	

- Lorsque vous sélectionnez un signal arbitraire comme source modulante, la fréquence devient la fréquence du signal arbitraire, qui est basée sur la fréquence d'échantillonnage et le nombre de points présents dans le signal arbitraire.
- Lorsque vous utilisez un signal arbitraire comme source modulante, la modification de ce paramètre se répercute sur les métadonnées en mémoire cache représentant la fréquence d'échantillonnage du signal arbitraire. Vous pouvez également modifier la fréquence modulante d'un signal arbitraire à l'aide des commandes **FUNCTion:ARbitrary:FREQuency**, **FUNCTion:ARbitrary:PERiod** et **FUNCTion:ARbitrary:SRATE**. Ces commandes et la commande de la fréquence de modulation sont directement couplées afin de maintenir exactement le même comportement du signal arbitraire que lors de sa dernière lecture. Si vous désactivez ultérieurement la modulation et sélectionnez le même signal arbitraire, sa fréquence d'échantillonnage (et la fréquence correspondante en fonction du nombre de points) sera la même que lors de sa lecture comme source de modulation.
- Si la fonction interne est TRiangle, UpRamp ou DnRamp, la fréquence maximale est limitée à 200 kHz sur la série 33500 ou à 800 kHz sur la série 33600. Si la fonction interne est PRBS, la fréquence fait référence au débit binaire et est limitée, **comme indiqué ici**.
- Cette commande doit être utilisée uniquement avec la source de modulation interne (**FM:SOURce INTernal**).



[SOURce[1|2]:]FM:INTernal:FUNction <fonction>

[SOURce[1|2]:]FM:INTernal:FUNction?

Cette commande sélectionne la forme du signal modulant.

Paramètre	Renvoi type
{SINusoid SQUare RAMP NRAMP TRIangle NOISe PRBS ARB}, SINusoid par défaut <b>Afficher les signaux de fonctions internes.</b>	SIN, SQU, RAMP, NRAM, TRI, NOIS, PRBS ou ARB
Sélectionnez un signal sinusoïdal comme signal modulant. FM:INT:FUNC SIN	

- Cette commande doit être utilisée uniquement avec la source de modulation interne (FM:SOURce INTernal).
- Certaines combinaisons de signal porteur et de fonction interne ne sont pas autorisées : signal porteur PRBS et fonction interne PRBS, signal porteur ARB et fonction interne ARB.
- Vous pouvez utiliser le bruit comme signal modulant. Toutefois, vous ne pouvez pas utiliser le bruit, des impulsions ou le courant continu comme signal porteur.

[SOURce[1|2]:]AM:SOURce {INTernal|EXTernal|CH1|CH2}  
[SOURce[1|2]:]AM:SOURce?

[SOURce[1|2]:]BPSK:SOURce {INTernal|EXTernal}  
[SOURce[1|2]:]BPSK:SOURce?

[SOURce[1|2]:]FM:SOURce {INTernal|EXTernal|CH1|CH2}  
[SOURce[1|2]:]FM:SOURce?

[SOURce[1|2]:]FSKey:SOURce {INTernal|EXTernal}  
[SOURce[1|2]:]FSKey:SOURce?

[SOURce[1|2]:]PM:SOURce {INTernal|EXTernal|CH1|CH2}  
[SOURce[1|2]:]PM:SOURce?

[SOURce[1|2]:]PWM:SOURce {INTernal|EXTernal|CH1|CH2}  
[SOURce[1|2]:]PWM:SOURce?

Sélectionne la source du signal modulant.

Paramètre	Renvoi type
{INTernal EXTernal CH1 CH2}, INTernal par défaut. BPSK et FSKey n'acceptent pas CH1 ou CH2	INT, EXT, CH1 ou CH2
Sélectionner la source de modulation externe : AM:SOUR EXT (peut également remplacer FM, BPSK, FSK, PM ou PWM pour AM)	

- Si vous sélectionnez EXTERNAL, le signal porteur est modulé par un signal externe. En particulier :
  - **AM** : La profondeur de modulation est contrôlée par le niveau de signal  $\pm 5$  V (ou le niveau de signal  $\pm 1$  V en option sur la série 33600) sur le connecteur **Modulation In** de la face arrière. Par exemple, si la profondeur de modulation (**AM[:DEPTH]**) est de 100 %, lorsque le signal modulant est à +5 V (ou éventuellement de +1 V sur la série 33600), l'amplitude de la sortie est maximale. De même, un signal modulant de -5 V (ou éventuellement de -1 V sur la série 33600) génère une amplitude de sortie minimale.
  - **FM** : Si vous sélectionnez la source modulante *externe*, la variation est contrôlée par le signal  $\pm 5$  V (éventuellement  $\pm 1$  V sur la série 33600) présent sur le connecteur **Modulation In** de la face arrière. Par exemple, si la variation de fréquence est de 100 kHz, un signal +5 V (éventuellement de +1 V sur la série 33600) correspond à une augmentation de fréquence de 100 kHz. Des signaux externes plus faibles produisent une variation moindre et les signaux négatifs réduisent la fréquence au-dessous de la fréquence porteuse.
  - **PM** : Avec la source modulante externe, la variation est contrôlée par le niveau de signal  $\pm 5$  V (éventuellement  $\pm 1$  V sur la série 33600) présent sur le connecteur **Modulation In** de la face arrière. Par exemple, si vous avez réglé la variation de fréquence sur 180 degrés, un niveau de signal +5 V (éventuellement  $\pm 1$  V sur la série 33600) correspond à une variation de +180 degrés. Des signaux externes plus faibles produisent une variation moindre et les signaux négatifs produisent une variation négative.
  - **Impulsion comme fonction sélectionnée** : La largeur d'impulsion ou la variation du rapport cyclique des impulsions est contrôlée par le niveau de signal  $\pm 5$  V (éventuellement  $\pm 1$  V sur la série 33600) présent sur le connecteur **Modulation In** de la face arrière. Par exemple, si vous avez défini la variation de la largeur d'impulsion à 50  $\mu$ s à l'aide de la commande **PWM:DEVIation**, un niveau de signal +5 V (éventuellement +1 V sur la série 33600) correspond à une augmentation de 50  $\mu$ s de la largeur. Des tensions externes inférieures produisent une variation inférieure.
- Avec la source EXTERNAL, la phase (BPSK) ou la fréquence (FSK) de sortie est déterminée par le niveau du signal sur le connecteur **Ext Trig** de la face arrière. Lorsque le niveau logique est bas, la phase ou la fréquence porteuse est envoyée. Lorsque le niveau logique est haut, le déphasage ou la fréquence de saut est envoyée.
- La fréquence externe maximale BPSK est de 1 MHz et la fréquence maximale FSK, de 1 MHz.
- **Remarque** : le connecteur utilisé pour les signaux BPSK ou FSK déclenchés extérieurement (**Trig In**) n'est pas le même que celui utilisé pour les signaux modulés extérieurement AM, FM, PM et PWM (**Modulation In**). Lorsqu'il est utilisé pour BPSK ou FSK, la polarité des fronts sur le connecteur **Trig In** n'est pas réglable ; ce connecteur n'est pas affecté par la commande **TRIGGER[1|2]:SLOPe**.
- Avec la source INTERNAL, la vitesse de commutation de la phase (BPSK) ou de la fréquence (FSKey) de sortie entre la phase ou la fréquence porteuse et la phase ou la fréquence alternative est déterminée par la vitesse BPSK (**BPSK:INTERNAL:RATE**) ou FSK (**FSKey:INTERNAL:RATE**).
- Une voie ne peut pas être sa propre source de modulation.

## Voir également

**INPut:ATTenuation[:STATe]**

**Sous-système AM**

Sous-système BPSK

Sous-système FM

Sous-système FSKey

Sous-système PM

Sous-système PWM

[SOURCE[1|2]:]AM:STATe {ON|1|OFF|0}  
[SOURCE[1|2]:]AM:STATe?

[SOURCE[1|2]:]BPSK:STATe {ON|1|OFF|0}  
[SOURCE[1|2]:]BPSK:STATe?

[SOURCE[1|2]:]FM:STATe {ON|1|OFF|0}  
[SOURCE[1|2]:]FM:STATe?

[SOURCE[1|2]:]FSKey:STATe {ON|1|OFF|0}  
[SOURCE[1|2]:]FSKey:STATe?

[SOURCE[1|2]:]PM:STATe {ON|1|OFF|0}  
[SOURCE[1|2]:]PM:STATe?

[SOURCE[1|2]:]PWM:STATe {ON|1|OFF|0}  
[SOURCE[1|2]:]PWM:STATe?

Active ou désactive la modulation.

Paramètre	Renvoi type
{ON 1 OFF 0}, OFF par défaut	0 (OFF) ou 1 (ON)
Activer la modulation AM (peut également être FM, BPSK, FSK, PM ou PWM) : AM:STAT ON	

- Pour éviter plusieurs modifications des signaux, activez la modulation après avoir configuré les autres paramètres de modulation.
- Vous ne pouvez activer qu'un seul mode de modulation à la fois.
- L'instrument n'active pas la modulation lorsque le mode balayage ou rafale est activé. Lorsque vous activez la modulation, le mode balayage ou rafale est désactivé.
- La modulation PWM est autorisée uniquement lorsque la fonction d'impulsion est sélectionnée.

#### Voir également

[Sous-système AM](#)

[Sous-système BPSK](#)

[Sous-système FM](#)

[Sous-système FSKey](#)

[Sous-système PM](#)

[Sous-système PWM](#)

FORMat:BORDER {NORMal|SWAPped}  
FORMat:BORDER?

Définit l'ordre des octets utilisés dans les transferts de points de données binaires en mode bloc.

Paramètre	Renvoi type
{ NORMal SWAPped }, default NORMal	NORM ou SWAP
Définir l'ordre SWAPped : FORM:BORD SWAP	

- **NORMal**: le bit de poids fort (MSB) de chaque point est le premier. Sélectionnez ce paramètre si vous utilisez les bibliothèques d'E/S Keysight.
- **SWAPped**: le bit de poids faible (LSB) de chaque point est le premier. La plupart des ordinateurs utilisent cette option.

## Sous-système FREQuency

Le sous-système FREQuency contrôle la fréquence de sortie de l'instrument. Dans les instruments 2 voies, les fréquences des voies peuvent être couplées de diverses manières.

La commande **FREQuency:COUPlE[:STATe] {ON|OFF|ONCE}** active ou désactive le couplage. Ou bien, à l'aide de l'option ONCE, elle copie une voie dans une autre sans la coupler à cette dernière.

**FREQuency:COUPlE:MODE {OFFSet|RATio}** spécifie le mode de couplage des fréquences.

**FREQuency:MODE** permet de spécifier le mode de fréquence à utiliser, y compris le balayage, une liste de fréquences ou une fréquence constante.

## Exemple

Les autres commandes FREQuency sont utilisées pour générer un balayage, comme résumé ci-dessous :

1. **Sélectionnez la forme, l'amplitude et la tension résiduelle du signal** : Utilisez la commande **APPLy** ou les commandes équivalentes **FUNcTion**, **FREQuency**, **VOLTage** et **VOLTage:OFFSet** pour sélectionner la fonction, la fréquence, l'amplitude et la tension résiduelle. Vous pouvez sélectionner n'importe quel signal non arbitraire.
2. **Définissez les limites de fréquence du balayage** : **FREQuency:START** et **FREQuency:STOP**, ou **FREQuency:CENTer** et **FREQuency:SPAN**.
3. **Sélectionnez le mode de balayage (linéaire ou logarithmique)** : **SWEep:SPACing**
4. **Définissez le temps de balayage en secondes** : **SWEep:TIME**
5. **Sélectionnez la source de déclenchement du balayage** : **TRIGger[1|2]:SOURce**
6. **Définissez la fréquence à laquelle le signal sur le connecteur Sync de la face avant passe au niveau bas pendant le balayage (facultatif)** : **MARKer:FREQuency**

[SOURce[1|2]:]FREQuency {<fréquence>|MINimum|MAXimum|DEFault}  
[SOURce[1|2]:]FREQuency? [{MINimum|MAXimum}]

Définit la fréquence de sortie. Cette commande est associée à la commande **FUNcTion:PULSe:PERiod** ; celle qui est exécutée a priorité sur l'autre.

Paramètre	Renvoi type
1 µHz à la <b>fréquence maximale de l'instrument</b> . Par défaut, 1 kHz.	+1,0000000000000000E+03
Définir la fréquence de sortie sur 60 Hz : FREQ 60	

- Limitations concernant les fonctions : les limites de fréquence dépendent de la fonction, comme indiqué dans le tableau ci-dessus. Si vous passez une commande qui spécifie une fréquence hors de la plage adaptée à la fonction active, une erreur se produit. Par exemple, si la fonction du courant est du type « rampe » et si vous passez la commande FREQ 20 MHZ, l'erreur « Data out of range » est générée et la fréquence est réglée sur 200 kHz (série 33500) ou 800 kHz (série 33600), valeur maximale pour une rampe.

[SOURce[1|2]:]FREQUency:CENTer {< fréquence >|MINimum|MAXimum|DEFault}  
[SOURce[1|2]:]FREQUency:CENTer? [{MINimum|MAXimum}]

Définit la fréquence médiane. Utilisée avec une plage de fréquences pour un balayage de fréquences.

Paramètre	Renvoi type
1 µHz à la <b>fréquence maximale de l'instrument</b> , 550 Hz par défaut	+1,0000000000000000E+03
Régler la fréquence médiane de balayage sur 1 kHz : FREQ:CENT 1000	

- L'équation suivante indique comment la plage de fréquence limite la fréquence médiane.

$$\text{Fréquence médiane (maxi)} = \text{Fréquence maximale du signal} - (\text{Plage}/2)$$

- L'équation suivante indique la relation entre la fréquence médiane et les fréquences initiale et finale.

$$\text{Fréquence médiane} = |(\text{Fréquence finale} - \text{Fréquence initiale})/2|$$

[SOURce[1|2]:]FREQUency:COUPlE[:STATe] {ON|1|OFF|0}  
[SOURce[1|2]:]FREQUency:COUPlE[:STATe]?

Active/désactive le couplage des fréquences entre les voies d'un instrument 2 voies.

Paramètre	Renvoi type
{ON 1 OFF 0}, OFF par défaut	0 (OFF) ou 1 (ON)
Activer le couplage des fréquences : FREQ:COUP ON	

- La sélection de ON entraîne le démarrage du couplage spécifié par **FREQUency:COUPlE:MODE**.
- Si la tension résiduelle ou le rapport actif, associé aux réglages de fréquence actifs, entraîne une fréquence supérieure aux spécifications de l'instrument, celui-ci génère une erreur ; la fréquence excédentaire est rognée à sa valeur maximale ou minimale.
- Si le mode est réglé sur RATIO et le paramètre RATIO est défini à 1.0, les spécifications ne sont toujours pas respectées (par ex., la voie 1 est un signal sinusoïdal de 3 MHz et la voie 2 est une rampe, qui ne peuvent atteindre cette fréquence), un message d'erreur est généré et la commande FREQUency:COUPlE est désactivée (OFF).



[SOURce[1|2]:]FREQuency:COUPle:MODE {OFFSet|RATio}

[SOURce[1|2]:]FREQuency:COUPle:MODE?

Définit le type de couplage des fréquences entre des voies couplées en fréquence ; OFFSet spécifie un décalage de fréquence constant entre les voies ; RATio spécifie un rapport constant entre les fréquences des voies.

Paramètre	Renvoi type
{OFFSet RATio}, RATio par défaut avec le rapport 1.0	OFFS ou RAT
Définir le mode de couplage des fréquences sur OFFSet : FREQ:COUP:MODE OFFS	

- La valeur par défaut du couplage des fréquences à la mise sous tension est OFF.
- SOURce1 ou SOURce2 n'ont pas d'effet ; quelle que soit la syntaxe, le mode de couplage est identique pour les 2 voies.

[SOURce[1|2]:]FREQuency:COUPle:OFFSet {<fréquence>|MINimum|MAXimum|DEFault}

[SOURce[1|2]:]FREQuency:COUPle:OFFSet?

Définit le décalage des fréquences lorsqu'un instrument est en mode de couplage OFFSet.

Paramètre	Renvoi type
Nombre compris entre les fréquences minimale et maximale du signal de l'instrument ; 0 par défaut.	+7,650000000000000E+05
Régler la fréquence de la voie 2 à 10,245 MHz au-dessus de la fréquence de la voie 1 : FREQ:COUP:OFFS 10,245 MHZ	
Régler la fréquence de la voie 1 à 350 kHz au-dessus de la fréquence de la voie 2 : SOUR2:FREQ:COUP:OFFS 350 KHZ	
Régler la fréquence de la voie 1 à 455 kHz au-dessus de la fréquence de la voie 2 : SOUR2:FREQ:COUP:OFFS -455 KHZ	

- La voie SOURce (SOURce1 ou SOURce2) est considérée comme la voie de référence et OFFSet s'applique à l'autre voie. Par exemple, supposons que l'instrument soit activé **FREQ:COUPLE:STATE ON** et en mode **FREQ:COUPLE:MODE OFFSET** (mode décalage des fréquences actif) et que la voie 1 fonctionne à 1,0 MHz. Avec la commande SOURce1:FREQuency:COUPle:OFFSet 500, la voie 1 demeure à 1,0 MHz et la voie 2 doit être réglée sur 1,5 MHz. Lorsque la fréquence d'une voie varie, la fréquence de l'autre voie varie pour conserver le décalage de 500 kHz.
  - Si le couplage des fréquences entraîne le dépassement des spécifications de fréquence de l'instrument pour les fonctions en cours, la commande provoque une erreur et la fréquence est réglée sur sa limite supérieure ou inférieure pour cette voie.
  - Le couplage des fréquences ne s'applique pas aux signaux arbitraires. Cependant, vous pouvez coupler la fréquence d'échantillonnage de signaux arbitraires.

[SOURce[1|2]:]FREQuency:COUPle:RATio <rapport>  
[SOURce[1|2]:]FREQuency:COUPle:RATio?

Définit le rapport du décalage entre les fréquences des voies en mode RATio de couplage des fréquences.

Paramètre	Renvoi type
0,001 à 1 000, 1 par défaut	+7,500000000000000E-01
Définir la fréquence de la voie 2 à une valeur deux fois supérieure à la fréquence de la voie 1 : FREQ:COUP:RAT 2,0  Définir la fréquence de la voie 1 à une valeur 3,14 fois supérieure à la fréquence de la voie 2 : SOUR2:FREQ:COUP:RAT 3,14	

- La voie SOURce (SOURce1 ou SOURce2) est considérée comme la voie de référence et RATIO s'applique à l'autre voie. Par exemple, supposons que le couplage des fréquences FREQuency:COUPle ON soit activé et en mode FREQuency:COUPle:MODE RATio. De plus, supposons que la voie 1 fonctionne à 2 kHz et la voie 2 à 10 kHz. Avec la commande SOURce1:FREQuency:COUPle:RATio 2.5, la voie 1 demeure à 2 kHz et la voie 2 doit être réglée sur 5 kHz. Lorsque la fréquence d'une voie varie, la fréquence de l'autre voie varie pour conserver le décalage de 2,5 kHz.
- Si le couplage des fréquences entraîne le dépassement des spécifications de fréquence de l'instrument pour les fonctions en cours, la commande provoque une erreur et la fréquence est réglée sur sa limite supérieure ou inférieure pour cette voie.
- Le couplage des fréquences ne s'applique pas aux signaux arbitraires. Cependant, vous pouvez coupler la fréquence d'échantillonnage de signaux arbitraires.

[SOURce[1|2]:]FREQuency:MODE {CW|LIST|SWEp|FIXed}  
[SOURce[1|2]:]FREQuency:MODE?

Réglez le mode de fréquence sur un signal continu à fréquence constante (CW ou FIXed), en balayage de fréquences (SWEp) ou sur une liste de fréquences (LIST).

Paramètre	Renvoi type
{CW LIST SWEp FIXed}, CW par défaut	CW, LIST, SWE ou FIX
Définir le mode de fréquence sur LIST : FREQ:MODE LIST	

- En mode liste, utilisez la commande LIST:FREQuency pour spécifier la liste des fréquences.

[SOURce[1|2]:]FREQuency:SPAN {<fréquence>|MINimum|MAXimum|DEFAULT}  
[SOURce[1|2]:]FREQuency:SPAN? [{MINimum|MAXimum}]

Réglez la plage de fréquence (utilisée avec la *fréquence médiane*) pour un balayage en fréquence.

Paramètre	Renvoi type
± <b>fréquence maximale du signal</b> de l'instrument, 900 Hz par défaut	+1,0000000000000000E+02
Régler la fréquence de fréquences sur 100 kHz : FREQ:SPAN 100 KHZ	

- L'équation suivante indique la limitation de la plage de fréquences maximale :

$$\text{Plage de fréquences (max.)} = (\text{Fréquence max. du signal choisi} - \text{Fréquence médiane}) \times 2$$

- L'équation suivante indique la relation entre la plage de fréquences et les fréquences initiale et finale.

$$\text{Plage de fréquence} = \text{Fréquence finale} - \text{Fréquence initiale}$$

- Pour balayer en fréquences croissantes, définissez une plage de fréquences positives ; pour balayer en fréquences décroissantes, définissez une plage de fréquences négatives.

[SOURce[1|2]:]FREQuency:STARt {<fréquence>|MINimum|MAXimum|DEFAULT}  
[SOURce[1|2]:]FREQuency:STARt? [{MINimum|MAXimum}]

[SOURce[1|2]:]FREQuency:STOP {<fréquence>|MINimum|MAXimum|DEFAULT}  
[SOURce[1|2]:]FREQuency:STOP? [{MINimum|MAXimum}]

Définit les fréquences initiale et finale d'un balayage de fréquences.

Paramètre	Renvoi type
± <b>fréquence maximale du signal</b> de l'instrument, 100 Hz par défaut	+1,0000000000000000E+02
Régler les fréquences initiale et finale de balayage sur 100 Hz et 1 kHz, respectivement : FREQ:STAR 100 FREQ:STOP 1000	

## Sous-système FSKey

Le sous-système FSKey configure un signal par déplacement de fréquence (FSK - Frequency-Shift Keying).

### Exemple

Vous trouverez ci-dessous un récapitulatif des opérations nécessaires à la génération d'un signal FSK.

1. Utilisez les commandes FUNCtion, FREQuency, VOLTage et VOLTage:OFFSet pour sélectionner la fonction, l'amplitude et la tension résiduelle du signal porteur.

2. Sélectionnez la source de modulation (interne, externe, CH1 ou CH2) : **FSK:SOURce**. Pour une source de modulation externe, ignorez les opérations 3 et 4.
3. Sélectionnez la fréquence de saut : **FSK:FREQuency**
4. Définissez la fréquence de cadencement FSK : **FSK:INTernal:RATE**
5. Activez la modulation FSK : **FSK:STATe ON**

Le code suivant produit l'image d'oscilloscope illustrée ci-dessous.

```

FUNction SQU
FREQuency +1e6
VOLTage +1,0
VOLTage:OFFset 0,0
FSKey:SOURce INT
FSKey:FREQuency +5e5
FSKey:INTernal:RATE +8e4
FSKey:STATe 1
OUTPut1 1

```

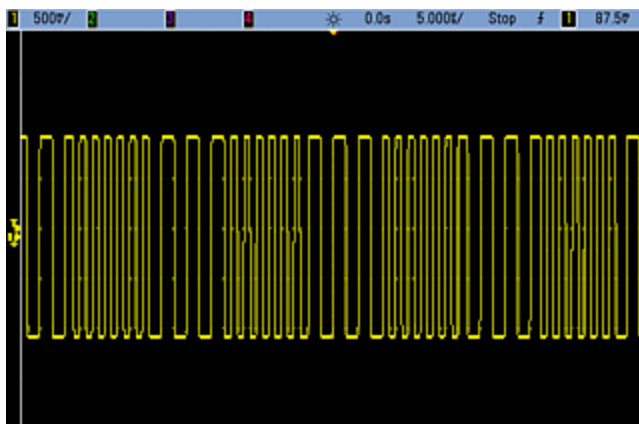

**[SOURce[1|2]:]FSKey:FREQuency {< fréquence >|MINimum|MAXimum|DEFault}**  
**[SOURce[1|2]:]FSKey:FREQuency? [{MINimum|MAXimum}]**

Définit la fréquence de saut (secondaire) FSK.

Paramètre	Renvoi type
1 µHz à la <b>fréquence d'instrument maximale du signal</b> , 100 Hz par défaut.	+1,0000000000000000E-06
Régler la fréquence de saut sur 10 kHz : FSK:FREQ 10000  Régler la fréquence de saut sur 1 µHz : FSK:FREQ MIN	

[SOURce[1|2]:]FSKey:INTernal:RATE {<fréquence\_en\_Hz>|MINimum|MAXimum}  
[SOURce[1|2]:]FSKey:INTernal:RATE? [{MINimum|MAXimum}]

Définit la cadence à laquelle la fréquence de sortie « passe » du signal porteur à la fréquence de saut.

Paramètre	Renvoi type
0,125 MHz à 1 MHz, 10 Hz par défaut	+1,0000000000000000E+01
Régler la cadence FSK sur 10 kHz : FSK:INT:RATE 10000  Régler la cadence FSK sur 1 MHz : FSK:INT:RATE MIN	

- La cadence FSK est uniquement utilisée avec la source interne (FSK:SOURce INTernal).
- Le signal modulant est un signal carré présentant un rapport cyclique de 50 %.

[SOURce[1|2]:]AM:SOURce {INTernal|EXTernal|CH1|CH2}  
[SOURce[1|2]:]AM:SOURce?

[SOURce[1|2]:]BPSK:SOURce {INTernal|EXTernal}  
[SOURce[1|2]:]BPSK:SOURce?

[SOURce[1|2]:]FM:SOURce {INTernal|EXTernal|CH1|CH2}  
[SOURce[1|2]:]FM:SOURce?

[SOURce[1|2]:]FSKey:SOURce {INTernal|EXTernal}  
[SOURce[1|2]:]FSKey:SOURce?

[SOURce[1|2]:]PM:SOURce {INTernal|EXTernal|CH1|CH2}  
[SOURce[1|2]:]PM:SOURce?

[SOURce[1|2]:]PWM:SOURce {INTernal|EXTernal|CH1|CH2}  
[SOURce[1|2]:]PWM:SOURce?

Sélectionne la source du signal modulant.

Paramètre	Renvoi type
{INTernal EXTernal CH1 CH2}, INTernal par défaut. BPSK et FSKey n'acceptent pas CH1 ou CH2	INT, EXT, CH1 ou CH2
Sélectionner la source de modulation externe : AM:SOUR EXT (peut également remplacer FM, BPSK, FSK, PM ou PWM pour AM)	

- Si vous sélectionnez EXTERNAL, le signal porteur est modulé par un signal externe. En particulier :
  - **AM** : La profondeur de modulation est contrôlée par le niveau de signal  $\pm 5$  V (ou le niveau de signal  $\pm 1$  V en option sur la série 33600) sur le connecteur **Modulation In** de la face arrière. Par exemple, si la profondeur de modulation (**AM[:DEPTH]**) est de 100 %, lorsque le signal modulant est à +5 V (ou éventuellement de +1 V sur la série 33600), l'amplitude de la sortie est maximale. De même, un signal modulant de -5 V (ou éventuellement de -1 V sur la série 33600) génère une amplitude de sortie minimale.
  - **FM** : Si vous sélectionnez la source modulante *externe*, la variation est contrôlée par le signal  $\pm 5$  V (éventuellement  $\pm 1$  V sur la série 33600) présent sur le connecteur **Modulation In** de la face arrière. Par exemple, si la variation de fréquence est de 100 kHz, un signal +5 V (éventuellement de +1 V sur la série 33600) correspond à une augmentation de fréquence de 100 kHz. Des signaux externes plus faibles produisent une variation moindre et les signaux négatifs réduisent la fréquence au-dessous de la fréquence porteuse.
  - **PM** : Avec la source modulante externe, la variation est contrôlée par le niveau de signal  $\pm 5$  V (éventuellement  $\pm 1$  V sur la série 33600) présent sur le connecteur **Modulation In** de la face arrière. Par exemple, si vous avez réglé la variation de fréquence sur 180 degrés, un niveau de signal +5 V (éventuellement  $\pm 1$  V sur la série 33600) correspond à une variation de +180 degrés. Des signaux externes plus faibles produisent une variation moindre et les signaux négatifs produisent une variation négative.
  - **Impulsion comme fonction sélectionnée** : La largeur d'impulsion ou la variation du rapport cyclique des impulsions est contrôlée par le niveau de signal  $\pm 5$  V (éventuellement  $\pm 1$  V sur la série 33600) présent sur le connecteur **Modulation In** de la face arrière. Par exemple, si vous avez défini la variation de la largeur d'impulsion à 50  $\mu$ s à l'aide de la commande **PWM:DEVIATION**, un niveau de signal +5 V (éventuellement +1 V sur la série 33600) correspond à une augmentation de 50  $\mu$ s de la largeur. Des tensions externes inférieures produisent une variation inférieure.
- Avec la source EXTERNAL, la phase (BPSK) ou la fréquence (FSK) de sortie est déterminée par le niveau du signal sur le connecteur **Ext Trig** de la face arrière. Lorsque le niveau logique est bas, la phase ou la fréquence porteuse est envoyée. Lorsque le niveau logique est haut, le déphasage ou la fréquence de saut est envoyée.
- La fréquence externe maximale BPSK est de 1 MHz et la fréquence maximale FSK, de 1 MHz.
- **Remarque** : le connecteur utilisé pour les signaux BPSK ou FSK déclenchés extérieurement (**Trig In**) n'est pas le même que celui utilisé pour les signaux modulés extérieurement AM, FM, PM et PWM (**Modulation In**). Lorsqu'il est utilisé pour BPSK ou FSK, la polarité des fronts sur le connecteur **Trig In** n'est pas réglable ; ce connecteur n'est pas affecté par la commande **TRIGGER[1|2]:SLOPe**.
- Avec la source INTERNAL, la vitesse de commutation de la phase (BPSK) ou de la fréquence (FSKey) de sortie entre la phase ou la fréquence porteuse et la phase ou la fréquence alternative est déterminée par la vitesse BPSK (**BPSK:INTERNAL:RATE**) ou FSK (**FSKey:INTERNAL:RATE**).
- Une voie ne peut pas être sa propre source de modulation.

## Voir également

**INPut:ATTenuation[:STATE]**

**Sous-système AM**

Sous-système BPSK

Sous-système FM

Sous-système FSKey

Sous-système PM

Sous-système PWM

[SOURce[1|2]:]AM:STATe {ON|1|OFF|0}  
[SOURce[1|2]:]AM:STATe?

[SOURce[1|2]:]BPSK:STATe {ON|1|OFF|0}  
[SOURce[1|2]:]BPSK:STATe?

[SOURce[1|2]:]FM:STATe {ON|1|OFF|0}  
[SOURce[1|2]:]FM:STATe?

[SOURce[1|2]:]FSKey:STATe {ON|1|OFF|0}  
[SOURce[1|2]:]FSKey:STATe?

[SOURce[1|2]:]PM:STATe {ON|1|OFF|0}  
[SOURce[1|2]:]PM:STATe?

[SOURce[1|2]:]PWM:STATe {ON|1|OFF|0}  
[SOURce[1|2]:]PWM:STATe?

Active ou désactive la modulation.

Paramètre	Renvoi type
{ON 1 OFF 0}, OFF par défaut	0 (OFF) ou 1 (ON)
Activer la modulation AM (peut également être FM, BPSK, FSK, PM ou PWM) : AM:STAT ON	

- Pour éviter plusieurs modifications des signaux, activez la modulation après avoir configuré les autres paramètres de modulation.
- Vous ne pouvez activer qu'un seul mode de modulation à la fois.
- L'instrument n'active pas la modulation lorsque le mode balayage ou rafale est activé. Lorsque vous activez la modulation, le mode balayage ou rafale est désactivé.
- La modulation PWM est autorisée uniquement lorsque la fonction d'impulsion est sélectionnée.

#### Voir également

[Sous-système AM](#)

[Sous-système BPSK](#)

[Sous-système FM](#)

[Sous-système FSKey](#)

[Sous-système PM](#)

[Sous-système PWM](#)



## Sous-système FUNCtion

Le sous-système FUNCtion configure la fonction de sortie de l'instrument :

- [SOURce[1|2]:]FUNCtion <fonction> - signal de sortie
- [SOURce[1|2]:]FUNCtion:ARBitrary {<nom de fichier>} - signal arbitraire (.arb/barb) ou séquence (.seq) précédemment chargé en mémoire volatile avec la commande MMEMory:LOAD:DATA[1|2].
- [SOURce[1|2]:]FUNCtion:ARBitrary:ADVance {TRIGger|SRATe} - méthode de progression jusqu'au point suivant du signal arbitraire.
- FUNCtion:ARBitrary:BALance[:STATe] {ON|1|OFF|0} - (Option lecteur IQ uniquement) état (on/off) de l'équilibrage de voies de signaux arbitraires doubles
- FUNCtion:ARBitrary:BALance:GAIN {<pourcentage>|MINimum|MAXimum|DEFine} - (Option lecteur IQ uniquement) rapport de balance du gain pour les signaux arbitraires doubles
- FUNCtion:ARBitrary:BALance:OFFSet{1|2} {<volts>|MINimum|MAXimum|DEFault} - (Option lecteur IQ uniquement) tension résiduelle des voies de signaux arbitraires doubles
- [SOURce[1|2]:]FUNCtion:ARBitrary:FILTer {NORMal|STEP|OFF} - filtre de signal arbitraire
- [SOURce[1|2]:]FUNCtion:ARBitrary:FREQuency {<fréquence>|MINimum|MAXimum|DEFault} - fréquence du signal arbitraire
- [SOURce[1|2]:]FUNCtion:ARBitrary:PERiod {<période>|MINimum|MAXimum|DEFault} - période du signal arbitraire
- [SOURce[1|2]:]FUNCtion:ARBitrary:POINts? - nombre de points (échantillons) contenus dans le signal arbitraire actif
- [SOURce[1|2]:]FUNCtion:ARBitrary:PTPeak {<tension>|MINimum|MAXimum|DEFault} - tension crête à crête du signal arbitraire
- FUNCtion:ARBitrary:SKEW[:STATe] {ON|1|OFF|0} - (Option lecteur IQ uniquement) état (on/off) du déphasage d'un signal arbitraire double
- FUNCtion:ARBitrary:SKEW:TIME [{<temps>|MINimum|MAXimum|DEFault}] - (Option lecteur IQ uniquement) durée du déphasage en secondes
- [SOURce[1|2]:]FUNCtion:ARBitrary:SRATe {<fréquence\_échantillonnage>|MINimum|MAXimum|DEFault} - fréquence d'échantillonnage du signal arbitraire
- [SOURce[1|2]:]FUNCtion:ARBitrary:SYNChronize - redémarre les signaux arbitraires simultanément dès le premier échantillon sur les deux signaux
- [SOURce[1|2]:]FUNCtion:NOISe:BANDwidth {<bande passante>|MINimum|MAXimum|DEFault} - bande passante du signal NOISe
- [SOURce[1|2]:]FUNCtion:PRBS:BRATe {<débit\_binaire>|MINimum|MAXimum|DEFault} - débit binaire d'une séquence binaire pseudo-aléatoire (PRBS)
- [SOURce[1|2]:]FUNCtion:PRBS:DATA <type\_séquence> - type de séquence PRBS

- [SOURCE[1|2]:]FUNCTION:PRBS:TRANSITION[:BOTH] {<secondes>|MINimum|MAXimum|DEFAULT} - temps de transition des fronts montant et descendant d'une séquence PRBS
- [SOURCE[1|2]:]FUNCTION:PULSE:DCYCLE {<pourcentage>|MINimum|MAXimum|DEFAULT} - rapport cyclique de l'impulsion
- [SOURCE[1|2]:]FUNCTION:PULSE:HOLD {WIDTH|DCYCLE} - indique que la largeur d'impulsion ou le rapport cyclique demeure constant lorsque d'autres paramètres varient
- [SOURCE[1|2]:]FUNCTION:PULSE:PERIOD {<secondes>|MINimum|MAXimum|DEFAULT} - période d'une impulsion
- [SOURCE[1|2]:]FUNCTION:PULSE:TRANSITION:LEADING {<secondes>|MINimum|MAXimum|DEFAULT}  
[SOURCE[1|2]:]FUNCTION:PULSE:TRANSITION:TRAILING {<secondes>|MINimum|MAXimum|DEFAULT}  
[SOURCE[1|2]:]FUNCTION:PULSE:TRANSITION[:BOTH] {<secondes>|MINimum|MAXimum|DEFAULT} - temps de front de l'impulsion
- [SOURCE[1|2]:]FUNCTION:PULSE:WIDTH {<secondes>|MINimum|MAXimum|DEFAULT} - largeur d'impulsion
- [SOURCE[1|2]:]FUNCTION:RAMP:SYMMETRY {<pourcentage>|MINimum|MAXimum|DEFAULT} - pourcentage de symétrie d'une rampe
- [SOURCE[1|2]:]FUNCTION:SQUARE:DCYCLE {<pourcentage>|MINimum|MAXimum} - pourcentage du rapport cyclique d'un signal carré
- [SOURCE[1|2]:]FUNCTION:SQUARE:PERIOD {<secondes>|MINimum|MAXimum|DEFAULT} - période d'un signal carré

[SOURce[1|2]:]FUNction <fonction>

[SOURce[1|2]:]FUNction?

Sélectionne la fonction de sortie.

Paramètre	Renvoi type
{SINusoid SQUare TRIangle RAMP PULSe PRBS NOISe ARB DC}, SINusoid par défaut	SIN, SQU, TRI, RAMP, PULS, PRBS, NOIS, ARB ou DC
Régler la sortie de la voie 2 sur un signal sinusoïdal : SOUR2:FUNC SIN	

- Le signal sélectionné (autre qu'un signal arbitraire) est envoyé en utilisant la fréquence, l'amplitude et la tension résiduelle précédemment sélectionnées. Les signaux arbitraires sont lus d'après les réglages spécifiés dans le fichier du signal arbitraire. Les nouveaux signaux arbitraires héritent des réglages actifs pour les signaux arbitraires.
- NOISe produit un bruit blanc gaussien ayant une bande passante réglable et un facteur de crête approximativement égal à 3,5.
- PRBS génère un bruit pseudo-aléatoire à l'aide des méthodes de registre à décalage à retour linéaire (LFSR - Linear Feedback Shift Register) choisies par l'utilisateur.
- ARB génère le signal arbitraire sélectionné par **FUNction:ARBitrary**.
- Limitations concernant les fonctions : Si vous passez à une fonction dont la fréquence maximale est inférieure à celle de la fonction active, la fréquence est ajustée à la valeur maximale de la nouvelle fonction. Par exemple, si vous modifiez un signal sinusoïdal haute fréquence pour la fonction rampe, l'instrument ajuste la fréquence de sortie à 200 kHz (limite supérieure des rampes). Sur l'interface distante, l'erreur « Settings conflict » est également générée.
- Limitations concernant l'amplitude : Si vous passez à une fonction dont l'amplitude maximale est inférieure à celle de la fonction active, l'amplitude est ajustée à la valeur maximale de la nouvelle fonction. C'est notamment le cas lorsque les unités de sortie sont *Veff* ou *dBm* en raison des différences de facteur de crête pour les diverses de fonctions de sortie. Par exemple, si vous modifiez un signal carré 5 Vrms (dans une charge de 50 Ω) en signal sinusoïdal, l'instrument ajuste l'amplitude à 3,536 Veff (limite maximale Vrms pour un signal sinusoïdal). L'interface distante génère également une erreur de conflit des paramètres.

[SOURCE[1|2]:]FUNCTION:ARbitrary {<nom de fichier>}

[SOURCE[1|2]:]FUNCTION:ARbitrary?

Sélectionne un signal arbitraire (.arb/barb) ou une séquence (.seq) précédemment chargé en mémoire volatile pour la voie spécifiée à l'aide de la commande **MMEMory:LOAD:DATA[1|2]** ou **DATA:ARbitrary**. Plusieurs signaux peuvent se trouver simultanément en mémoire volatile.

Paramètre	Renvoi type
Reportez-vous à la section <b>MMEMory:LOAD:DATA[1 2]</b> pour connaître les formats de <nom de fichiers> valides.	"INT:\MyArb103.arb"
Sélectionner un signal arbitraire en mémoire sur la voie 2 : FUNC:ARB "INT:\MyArb103.arb"  Chargez un signal arbitraire du lecteur interne en mémoire volatile. Sélectionnez et lisez ensuite le signal : MMEM:LOAD:DATA "INT:\BUILTIN\Sinc.arb" FUNCTION:ARbitrary "INT:\BUILTIN\Sinc.arb" FUNCTION ARB	

- Le <nom de fichier> doit correspondre au nom utilisé pour charger le signal arbitraire en mémoire volatile avec la commande **MMEMory:LOAD:DATA[1|2]**, **DATA:ARbitrary**, **DATA:ARbitrary:DAC** ou **DATA:SEQUence**.
- Lorsque vous enregistrez un segment ou une séquence de signal arbitraire (**MMEMory:STORe:DATA[1|2]**), les réglages actuels de l'instrument (tensions, fréquence d'échantillonnage, type de filtre, etc.) sont enregistrés dans le fichier du segment ou de la séquence. Lorsque vous lisez le fichier pour la première fois avec la commande **FUNCTION:ARbitrary**, ces paramètres sont chargés et remplacent les réglages actuels de l'instrument. Si vous avez modifié manuellement le fichier d'un segment ou d'une séquence en supprimant les paramètres de l'instrument, les réglages de l'instrument ne sont pas modifiés lorsque vous exécutez la commande **FUNCTION:ARbitrary**.
- Lorsque vous enregistrez un segment ou une séquence de signal arbitraire (**MMEMory:STORe:DATA[1|2]**), les réglages actuels de l'instrument (tensions, fréquence d'échantillonnage, type de filtre, etc.) sont enregistrés dans le fichier du segment ou de la séquence. Lorsque vous lisez le fichier pour la première fois avec la commande **FUNCTION:ARbitrary**, ces paramètres sont chargés et remplacent les réglages actuels de l'instrument. Si vous avez modifié manuellement le fichier d'un segment ou d'une séquence en supprimant les paramètres de l'instrument, les réglages de l'instrument ne sont pas modifiés lorsque vous exécutez la commande **FUNCTION:ARbitrary**.

[SOURce[1|2]:]FUNcTion:ARBitrary:ADVance {TRIGger|SRATe}  
[SOURce[1|2]:]FUNcTion:ARBitrary:ADVance?

Indique la méthode de progression jusqu'au point suivant du signal arbitraire pour la voie spécifiée.

Paramètre	Renvoi type
{TRIGger SRATe}, TRIG par défaut	TRIG ou SRAT
Définir la méthode de progression jusqu'au déclenchement : FUNCtion:ARBitrary:ADV TRIG	

- TRIGger fait progresser l'instrument à la valeur du point suivant à chaque déclenchement reçu et force l'option EXTERNAL pour la commande TRIGger[1|2]:SOURce.
- SRATe fait progresser l'instrument à la valeur du point suivant avec la fréquence d'échantillonnage configurée par FUNCtion:ARBitrary:SRATe.

[SOURce[1|2]:]FUNcTion:ARBitrary:FILTer {NORMal|STEP|OFF}  
[SOURce[1|2]:]FUNcTion:ARBitrary:FILTer?

Spécifie le filtre d'un signal arbitraire.

Paramètre	Renvoi type
{NORMal STEP OFF}, STEP par défaut	NORMal, STEP ou OFF
Régler le filtre sur NORMal : FUNCtion:ARBitrary:FILTer NORM	

- L'option **NORMal** filtre les valeurs des points avec le filtre qui offre la réponse en fréquence la plus plate. Cela lisse efficacement le signal, mais les transitions rapides comporteront des pré-dépassements et des suroscillations.
- L'option **STEP** filtre les valeurs des points pour lisser efficacement le signal tout en minimisant les pré-dépassements et les suroscillations. Cependant, cette option offre une bande passante inférieure à celle de l'option NORMal.
- **OFF** passe d'un point à l'autre à la fréquence d'échantillonnage. Les déplacements entre les points s'effectuent aussi rapidement que possible sans lissage. Si le <mode> est désactivé (OFF), l'instrument utilise un filtre dont la bande passante limite réduit la fréquence d'échantillonnage maximale du signal arbitraire à 62.5 M.éch/s (série 33500) ou 250 M.éch/s (série 33600).
- Pour utiliser cette commande sur la série 33600, vous devez désactiver FUNCtion:ARBitrary:FILTer.

[SOURce[1|2]:]FUNction:ARBitrary:FREQuency {<fréquence>|MINimum|MAXimum|DEFault}  
[SOURce[1|2]:]FUNction:ARBitrary:FREQuency? {MINimum|MAXimum}

[SOURce[1|2]:]FUNction:ARBitrary:PERiod {<période>|MINimum|MAXimum}DEFault}  
[SOURce[1|2]:]FUNction:ARBitrary:PERiod? {MINimum|MAXimum}

Définit la fréquence ou la période du signal arbitraire.

Paramètre	Renvoi type
<fréquence> (Hz) : Limité par le nombre de points du signal ; valeur par défaut basée sur une fréquence d'échantillonnage 40 k.éch/s.	+1,000000000000000E+03
<période> (secondes) : Limité par le nombre de points du signal ; valeur par défaut basée sur une fréquence d'échantillonnage 40 k.éch/s.	+1,000000000000000E-03
Réglez la fréquence du signal arbitraire sur 1 000 Hz. FUNC:ARB:FREQ 1000	

- Avec la commande **FUNction:ARBitrary:FiLTer OFF**, la fréquence d'échantillonnage du signal arbitraire est limitée au quart (1/4) de la fréquence d'échantillonnage maximale.
- La <fréquence> est comprise entre 1 µHz et 31,25 MHz sur la série 33500, ou de 250 MHz sur la série 33600. La fréquence est également limitée par le paramètre Filtre. Avec **FUNction:ARBitrary:FiLTer OFF**, la fréquence d'échantillonnage du signal arbitraire est limitée à 62,5 M.éch/s. Par conséquent, la fréquence est également réduite à 7,8125 MHz pour un signal de 8 points (série 33500) ou au quart de celle d'un signal de 32 points (série 33600).
- La fréquence et la fréquence d'échantillonnage du signal arbitraire ne sont pas couplées avec **SOUR:FREQ**, qui s'applique uniquement aux signaux non arbitraires.
- Le signal arbitraire est lu à la vitesse spécifiée par la fréquence d'échantillonnage. Lorsque vous définissez la fréquence ou la période d'un signal arbitraire, l'instrument modifie la fréquence d'échantillonnage en fonction du nombre de points dans le signal et de la nouvelle fréquence ou de la nouvelle période. La nouvelle fréquence ou période peut être légèrement modifiée pour respecter les limitations de résolution de la fréquence d'échantillonnage et du nombre de points. En d'autres termes, la fréquence est recalculée à partir de la nouvelle fréquence d'échantillonnage et du nombre de points pour assurer la compatibilité entre les paramètres couplés. Cela est dû à la résolution mathématique de 15 chiffres associée à une fréquence d'échantillonnage qui peut également être exprimée sur 15 chiffres.
- Toute modification du nombre de points du signal ou de la fréquence d'échantillonnage à l'aide de la commande **FUNction:ARBitrary:SRATe** est répercutée sur les réglages de fréquence et de période.

### [SOURce[1|2]:]FUNction:ARBitrary:POINts?

Renvoie le nombre de points dans le signal arbitraire actuellement sélectionné.

Paramètre	Renvoi type
(aucun)	+100000
Renvoyer le nombre de points du signal arbitraire actif de la voie 1 : FUNC:ARB:POIN?	

- Le nombre maximal de points varie selon la mémoire de l'instrument, qui dépend du **modèle et des options**.

[SOURce[1|2]:]FUNcTion:ARBITrary:PTPeak {< tension>|MINimum|MAXimum|DEFault}

[SOURce[1|2]:]FUNcTion:ARBITrary:PTPeak? [{MINimum|MAXimum}]

Configure la tension crête à crête.

Paramètre	Renvoi type
10 VDC dans 50 Ω, 20 Vcc dans un circuit ouvert ; 100 mV par défaut	+4,000000000000000E+00
Régler la tension crête à crête sur 4 V : FUNC:ARBITrary:PTPeak 4	

- *Limites imposées par l'amplitude* : Vous pouvez configurer des niveaux de tension positifs ou négatifs avec les limitations ci-dessous. Vpp est l'amplitude maximale crête à crête de l'impédance de sortie sélectionnée (10 Vpp dans une charge de 50 Ω ou 20 Vpp dans un circuit ouvert).

$$V_{\text{high}} - V_{\text{low}} \leq V_{\text{pp}} (\text{max}) \text{ et } V_{\text{high}}, V_{\text{low}} \leq V_{\text{pp}} (\text{max})/2$$

- *Différences entre l'utilisation à distance et sur la face avant* :
  - **Interface distante** : La configuration du niveau haut ou bas à partir de l'interface distante peut modifier le niveau haut ou bas pour obtenir le réglage souhaité. Dans ce cas, l'erreur « Data out of range » ou « Settings conflict » s'affiche. Si le niveau haut est défini sous le niveau bas, l'instrument configure le niveau bas 1 mV sous le niveau haut. Si le niveau bas est configuré sous la limite inférieure (LOW) ou des spécifications de sortie de l'instrument, le niveau bas est réglé sur la limite inférieure (LOW) ou les spécifications de sortie de l'instrument et le niveau haut est défini à 1 mV au-dessus du niveau bas. Un ensemble de règles similaires s'applique si le niveau bas est configuré incorrectement.
  - De même, vous pouvez configurer le niveau bas au-dessus du niveau haut à partir de l'interface distante. Dans ce cas, l'instrument définit le niveau haut à 1 mV au-dessus du niveau bas. Si le niveau bas est supérieur à la limite maximale (HIGH) des spécifications de sortie de l'instrument, le niveau haut est configuré avec la limite maximale (HIGH) ou les spécifications de sortie de l'instrument et le niveau bas est défini à 1 mV au-dessous du niveau haut.
  - **Face avant** : La configuration du niveau haut ou bas sur la face avant peut rogner ce niveau pour obtenir le niveau souhaité ; l'erreur « Data out of range » est générée. Il n'est pas possible de configurer un niveau haut inférieur au niveau bas sur la face avant.
- La configuration des niveaux haut et bas entraîne également celle de l'amplitude et de la tension résiduelle du signal. Par exemple, si vous réglez le niveau haut sur +2 V et le niveau bas sur -3 V, l'amplitude résultante est de 5 Vpp avec une tension résiduelle de -500 mV.
- *Limites imposées par l'impédance de sortie* : Si vous modifiez le réglage de la terminaison de sortie, la tension affichée est ajustée (aucune erreur n'est générée). Par exemple, si vous définissez le niveau haut à +100 mVcc et que vous modifiez ensuite la terminaison de sortie de 50 Ω à « haute impédance », l'amplitude affichée sur la face avant double et devient +200 mVcc. Si vous changez de « haute impédance » à 50 Ω, l'amplitude affichée est divisée par 2. La modification de l'impédance de sortie n'a aucune répercussion sur la tension aux bornes de sortie de l'instrument. Seules les valeurs affichées sur la face avant et les valeurs demandées sur l'interface distante sont modifiées. La tension sur la sortie de l'instrument dépend de la charge connectée à l'instrument. Pour plus d'informations, reportez-



vous à la commande **OUTPut[1|2]:LOAD**.

- Limites imposées par les limites de tension : Si les limites de tension sont activées, les réglages de tension sont vérifiés par rapport aux limites spécifiées (**VOLTage:LIMit:HIGH**, **VOLTage:LIMit:LOW**) avant qu'un changement de niveau ne soit effectué. Si le niveau de sortie varie au-delà du réglage LIMIT, il est fixé au maximum (ou minimum) autorisé qui n'est pas supérieur à cette valeur LIMit ; l'erreur « Settings conflict » est générée.
- Limites imposées par le couplage des sorties : Si 2 voies sont couplées, les limites sont vérifiées sur ces 2 voies avant de modifier un niveau. Dans ce cas, si le niveau varie au-delà du réglage LIMIT ou des spécifications de sortie de l'instrument pour une des voies, il est fixé au maximum (ou minimum) autorisé ; l'erreur « Settings conflict » est générée.
- Pour inverser un signal par rapport à la tension résiduelle, utilisez **OUTPut[1|2]:POLarity**.

**[SOURce[1|2]:]FUNCTion:ARBITrary:SRATe {<fréquence\_échantillonnage>|MINimum|MAXimum|DEFault}**  
**[SOURce[1|2]:]FUNCTion:ARBITrary:SRATe? {MINimum|MAXimum}**

Définit la fréquence d'échantillonnage du signal arbitraire.

Paramètre	Renvoi type
1 µSa/s à 250 M.éch/s (série 33500) ou 1 Géch/s (série 33600), 40 M.éch/s par défaut. Limité à 62,5 M.éch/s (série 33500) ou 250 M.éch/s (série 33600) si FUNCTion:ARBITrary:FILTer est désactivé (OFF).	+1,0000000000000000E+04
Régler la fréquence d'échantillonnage sur 10 M.éch/s : FUNC:ARB:SRAT 1e4	

- La fréquence d'échantillonnage et la fréquence ne sont pas couplées lors de la lecture d'un segment de signal arbitraire. Le concept de fréquence ne s'applique pas aux séquences de signaux arbitraires.
- La définition d'une fréquence d'échantillonnage en mode non ARB ne modifie pas la fréquence. Par exemple, si la fonction active est un signal sinusoïdal (sine), la définition de la fréquence d'échantillonnage n'a pas d'effet tant que la fonction n'est pas modifiée à ARB.
- La fréquence maximale d'échantillonnage dépend du filtre appliqué au signal arbitraire. Pour plus d'informations, reportez-vous à la section **FUNCTion:ARBITrary:FILTer**.

## [SOURce[1|2]:]FUNCtion:ARBitrary:SYNChronize

Provoque la synchronisation de deux signaux arbitraires indépendants sur le premier point de chaque signal (instruments 2 voies uniquement).

Paramètre	Renvoi type
(aucun)	(aucun)
<p>Chargez un signal interne demi-sinus inverse (Haversine) dans la voie 1 et un signal arbitraire à partir d'une clé USB dans la voie 2. Configurez les deux fréquences d'échantillonnage à 100 k.éch/s et synchronise les deux voies sur le premier point de chaque signal :</p> <pre>MMEM:LOAD:DATA "Int:\Builtin\HAVERSINE.arb" FUNC:ARB "Int:\Builtin\HAVERSINE.ARB" FUNC ARB FUNC:ARB:SRATE 1E+05  MMEM:LOAD:DATA2 "USB:\MyFiles\TestDUT3.arb" SOUR2:FUNC:ARB "USB:\MyFiles\TestDUT3.arb" SOUR2:FUNC ARB SOUR2:FUNC:ARB:SRAT 1E+05  FUNC:ARB:SYNC</pre>	

- Cette commande interrompt et redémarre les signaux arbitraires sur les deux voies aux fréquences d'échantillonnage configurées.
- Si les deux signaux arbitraires comportent le même nombre de points et la même fréquence d'échantillonnage, ils demeurent synchronisés sur plusieurs répétitions. Sinon, ils sont synchronisés initialement et après plusieurs répétitions qui représentent des multiples du nombre de points dans chaque signal. Par exemple, si vous synchronisez un signal de 8 points et un signal de 10 points, ils sont resynchronisés après 40, 80 et 120 répétitions.
- Cette fonctionnalité est similaire au mode rafale, mais elle fonctionne en mode de signal continu.
- Cette commande fonctionne également en mode balayage, rafale et modulation lorsque vous tentez de synchroniser deux signaux arbitraires.

[SOURce[1|2]:]FUNCTION:NOISe:BANDwidth {<bande passante>|MINimum|MAXimum|DEFAULT}  
[SOURce[1|2]:]FUNCTION:NOISe:BANDwidth? [{MINimum|MAXimum}]

Configure la bande passante du bruit.

Paramètre	Renvoi type
1 mHz à la <b>fréquence maximale</b> de l'instrument, 100 kHz par défaut	+6,000000000000000E+03
Régler la bande passante sur 20 kHz : FUNC:NOISe:BWIDth 20000	

- La fonction Bruit génère un bruit blanc gaussien avec un facteur de crête de 4,6.
- La bande passante du bruit est en permanence réglable pour placer plus d'énergie parasite dans la plage de fréquences de 0 Hz à la fréquence spécifiée pour la bande passante du bruit.

[SOURce[1|2]:]FUNCTION:PRBS:BRATe {<débit\_binaire>|MINimum|MAXimum|DEFAULT}  
[SOURce[1|2]:]FUNCTION:PRBS:BRATe? [{MINimum|MAXimum}]

Définit le débit binaire d'une séquence binaire pseudo-aléatoire (PRBS).

Paramètre	Renvoi type
1 mbit/s à la valeur maximale autorisée pour l'instrument, 1 000 bit/s par défaut	+1,920000000000000E+04
Régler le débit binaire sur 19 200 bits par seconde : FUNC:PRBS:BRATe 19200	

- Un signal PRBS utilisant le polynôme PN $x$  est créé par un registre à décalage de  $x$  bits. Le signal de sortie commence par  $x$  périodes d'échantillonnage de haut débit. La période d'échantillonnage est l'inverse de la fréquence d'échantillonnage (FUNCTION:PRBS:BRATe) et l'impulsion **Sync** de la voie indique le début du signal. Par exemple, si le signal PRBS utilise PN23 avec une fréquence d'échantillonnage de 500 Hz, la sortie commence avec une fréquence haut débit de 46 ms (23 x 2 ms).
- Le débit binaire est indépendant de la longueur de la séquence des données.

[SOURCE[1|2]:]FUNCTION:PRBS:DATA <type\_séquence>

[SOURCE[1|2]:]FUNCTION:PRBS:DATA?

Définit le type de séquence binaire pseudo-aléatoire (PRBS). La configuration du type de séquence entraîne la définition de la longueur et des valeurs de retour, comme indiqué ci-dessous.

Paramètre	Renvoi type
Série 33500 : {PN7 PN9 PN11 PN15 PN20 PN23} Série 33600 : PN3 à PN32 (les 30 valeurs possibles de 3 à 32)  La valeur après PN correspond à la longueur maximale du registre à décalage en bits. La valeur par défaut est PN7.	PN# (PN3 à PN9) ou PN## (PN10 à PN32), où chaque signe # correspond à un chiffre.
Configurer le format des données sur PN23 : FUNC:PRBS:DATA PN23	

- La sortie SYNC peut être active pendant une fonction PRBS, à la différence de la fonction **NOISE**. La sortie SYNC marque le premier bit de données d'un signal PRBS.

- Un signal PRBS utilisant le polynôme PN $x$  est créé par un registre à décalage de  $x$  bits. Le signal de sortie commence par  $x$  périodes d'échantillonnage de haut débit. La période d'échantillonnage est l'inverse de la fréquence d'échantillonnage (**FUN**Ction:PRBS:BRATe) et l'impulsion **Sync** de la voie indique le début du signal. Par exemple, si le signal PRBS utilise PN23 avec une fréquence d'échantillonnage de 500 Hz, la sortie commence avec une fréquence haut débit de 46 ms (23 x 2 ms). Les polynômes sont indiqués ci-dessous.

Type de séquence	Polynôme	Longueur
PN3	$x^3 + x^2 + 1$	3
PN4	$x^4 + x^3 + 1$	4
PN5	$x^5 + x^3 + 1$	5
PN6	$x^6 + x^5 + 1$	6
PN7	$x^7 + x^6 + 1$	7
PN8	$x^8 + x^6 + x^5 + x^4 + 1$	8
PN9	$x^9 + x^5 + 1$	9
PN10	$x^{10} + x^7 + 1$	10
PN11	$x^{11} + x^9 + 1$	11
PN12	$x^{12} + x^6 + x^4 + x^1 + 1$	12
PN13	$x^{13} + x^4 + x^3 + x^1 + 1$	13
PN14	$x^{14} + x^5 + x^3 + x^1 + 1$	14
PN15	$x^{15} + x^{14} + 1$	15
PN16	$x^{16} + x^{15} + x^{13} + x^4 + 1$	16
PN17	$x^{17} + x^{14} + 1$	17
PN18	$x^{18} + x^{11} + 1$	18
PN19	$x^{19} + x^6 + x^2 + x^1 + 1$	19
PN20	$x^{20} + x^{17} + 1$	20
PN21	$x^{21} + x^{19} + 1$	21
PN22	$x^{22} + x^{21} + 1$	22
PN23	$x^{23} + x^{18} + 1$	23
PN24	$x^{24} + x^{23} + x^{22} + x^{17} + 1$	24
PN25	$x^{25} + x^{22} + 1$	25
PN26	$x^{26} + x^6 + x^2 + x^1 + 1$	26

Type de séquence	Polynôme	Longueur
PN27	$x^{27} + x^5 + x^2 + x^1 + 1$	27
PN28	$x^{28} + x^{25} + 1$	28
PN29	$x^{29} + x^{27} + 1$	29
PN30	$x^{30} + x^6 + x^4 + x^1 + 1$	30
PN31	$x^{31} + x^{28} + 1$	31
PN32	$x^{32} + x^{22} + x^2 + x^1 + 1$	32

[SOURCE[1|2]:]FUNCTION:PRBS:TRANSITION[:BOTH] {<secondes>|MINimum|MAXimum|DEFAULT}  
 [SOURCE[1|2]:]FUNCTION:PRBS:TRANSITION[:BOTH]? [{MINimum|MAXimum}]

Configure le temps de transition des fronts d'une séquence PRBS.

Paramètre	Renvoi type
Série 33500 : 8,4 ns (par défaut) à 1 µs, limité comme décrit ci-dessous Série 33600 : 2,9 ns jusqu'à 4 Vpp, et 3,3 ns au-dessus de 4 Vpp à 1 µs ; limité comme indiqué ci-dessous	+1,0000000000000000E-08
Régler le temps des fronts montant et descendant sur 10 ns (deux méthodes) : FUNC:PRBS:TRAN 10 ns FUNC:PRBS:TRAN ,000000010	

- Le mot clé « BOTH » par défaut est facultatif et permet de contrôler simultanément les fronts montant et descendant du signal PRBS.
- Le temps de front s'applique aux fronts montant et descendant ; il représente le temps entre 10 et 90 % du seuil.
- Le temps de front spécifié doit être contenu dans la période spécifiée. L'instrument limite le temps de front le cas échéant afin qu'il tienne compte du débit binaire spécifié. Sur l'interface distante, l'erreur « Settings conflict » est également générée.

[SOURCE[1|2]:]FUNCTION:PULSE:DCYCLE {<pourcentage>|MINimum|MAXimum|DEFAULT}  
 [SOURCE[1|2]:]FUNCTION:PULSE:DCYCLE? [{MINimum|MAXimum}]

Définit le rapport cyclique de l'impulsion.

Paramètre	Renvoi type
0 à 100, limité comme décrit ci-dessous ; 10 par défaut	+5,000000000000000E+01
Régler le rapport cyclique sur 50 % : FUNC:PULSE:DCYC 50	

- Les commandes **FUNCTION:PULSE:DCYCLE** et **FUNCTION:PULSE:WIDTH** affectent le même paramètre. Dans certaines applications, il est naturel de régler directement la largeur d'impulsion (en secondes) ; dans d'autres, il semble plus logique de régler le rapport cyclique. Lorsque la fréquence est réglée, si la largeur d'impulsion a été réglée plus récemment que le rapport cyclique sur la face avant, le rapport cyclique demeure constant lorsque la fréquence ou la période change. Cependant, si la largeur d'impulsion était le dernier réglage, elle demeure constante lorsque la fréquence ou la période change. Reportez-vous à la commande **FUNCTION:PULSE:HOLD**.
- Le rapport cyclique de l'impulsion est défini comme suit :

$$\text{Rapport cyclique} = 100 \times \text{Largeur d'impulsion} \div \text{Période}$$

La largeur d'impulsion est le temps qui s'écoule entre le niveau de 50 % du front montant et le niveau de 50 % du front descendant suivant de l'impulsion.

- Le rapport cyclique est compris entre 0 et 100 %. Cependant, le rapport cyclique est limité par la *largeur d'impulsion minimale* et le *temps de front* qui empêchent de le régler exactement sur 0 ou 100 %. Par exemple, pour une impulsion de 1 kHz, vous êtes généralement limité à des rapports cycliques compris entre 0,002 et 99,998 %. Le rapport cyclique est limité par la largeur d'impulsion minimale de 16 ns sur la série 33500, ou de 5 ns jusqu'à 4 Vpp et 8 ns jusqu'à 10 Vpp sur la série 33600.
- Restrictions basées sur la largeur d'impulsion : Le rapport cyclique spécifié pour une impulsion doit respecter les conditions suivantes imposées par la *largeur d'impulsion minimale*. L'instrument règle le rapport cyclique des impulsions afin qu'il soit compatible avec la période spécifiée. *Sur l'interface distante, l'erreur « Settings conflict » est également générée.*

$$\text{Rapport cyclique} \geq 100(\text{Largeur d'impulsion minimale}/\text{Période})$$

et

$$\text{Rapport cyclique} \leq 100(1 - (\text{Largeur d'impulsion minimale}/ \text{Période}))$$

Sur la série 33500, la largeur d'impulsion minimale est de 16 ns. Sur la série 33600, la largeur d'impulsion minimale est de 5 ns jusqu'à 4 Vpp et de 8 ns jusqu'à 10 Vpp.

- *Restrictions basées sur le temps de front et impactant ce dernier* : Le rapport cyclique spécifié pour les impulsions peut avoir une incidence sur le temps de front. Le temps de front est d'abord ajusté, suivi du rapport cyclique pour tenir compte de la période spécifiée conformément à la restriction suivante. Sur l'interface distante, l'erreur « Settings conflict » est également générée.

$$\text{Rapport cyclique} \geq [(0,8 \times \text{Temps du front montant}) + (0,8 \times \text{Temps du front descendant})] / \text{Période} \times 100$$

et

$$\text{Rapport cyclique} \leq [1 - [(0,8 \times \text{Temps du front montant}) + (0,8 \times \text{Temps du front descendant})] / \text{Période}] \times 100$$

[SOURCE[1|2]:]FUNCTION:PULSE:HOLD {WIDTH|DCYCLE}

[SOURCE[1|2]:]FUNCTION:PULSE:HOLD?

Définit le paramètre de train d'impulsions (largeur d'impulsion ou rapport cyclique) à une valeur constante lorsque les autres paramètres varient.

Paramètre	Renvoi type
{WIDTH DCYCLE}, WIDTH par défaut	WIDT ou DCYC
Configurer l'instrument pour maintenir le rapport cyclique des trains d'impulsion : FUNC:PULS:HOLD DCYC	

- **WIDTH** : l'instrument maintient constante la largeur d'impulsion (en secondes) lorsque la période varie. Si une commande de configuration d'un rapport cyclique est reçue, celui-ci est converti en largeur d'impulsion équivalente. Si la modulation de largeur d'impulsion (PWM) est activée, la largeur d'impulsion et la variation de largeur sont conservées lorsque la période varie. Les commandes de variation du rapport cyclique sont converties en variations de largeur.

Des restrictions minimales sur la largeur et le temps de front s'appliquent. Peut entraîner la modification des temps de front et de la largeur d'impulsion sélectionnés ou des deux.

- **DCYCLE** : l'instrument maintient constant le rapport cyclique des impulsions (en pourcentage) lorsque la période varie. Si une commande de configuration de la largeur d'impulsion est reçue, celle-ci est convertie en rapport cyclique équivalent. Si la modulation de largeur d'impulsion (PWM) est activée, le rapport cyclique des impulsions et la variation du rapport sont conservés lorsque la période varie. Les commandes de variation de la largeur sont converties en rapport cyclique.

Des restrictions minimales sur la largeur et le temps de front s'appliquent. Peut entraîner la modification des temps de front et du rapport cyclique sélectionnés ou des deux.

**REMARQUE**

La commande FUNCTION:PULSE:HOLD ne limite pas les réglages de période. La largeur d'impulsion ou le rapport cyclique peuvent être réglés le cas échéant pour tenir compte de la configuration d'une nouvelle période.



[SOURCE[1|2]:]FUNCTION:PULSE:PERiod {<secondes>|MINimum|MAXimum|DEFault}

[SOURCE[1|2]:]FUNCTION:PULSE:PERiod? [{MINimum|MAXimum}]

Définit la période d'impulsion. Cette commande est associée à la commande **FREQuency** ; celle qui est exécutée en dernier a priorité sur l'autre, du fait que la fréquence et la période spécifient le même paramètre.

Paramètre	Renvoi type
De l'inverse de la <b>fréquence maximale</b> de l'instrument jusqu'à 1 000 000 s. Par défaut, 1 ms	+2,0000000000000000E-07
Définir la période à 500 ms : FUNC:PULS:PER ,5 ou FUNC:PULS:PER 500 ms	

- La période spécifiée doit être supérieure à la somme de la largeur d'impulsion et du temps de front. L'instrument ajuste la largeur d'impulsion et le temps de front en fonction de la période spécifiée. Sur l'interface distante, l'erreur « Settings conflict » est également générée. Le temps de front est d'abord minimisé, suivi de la largeur (ou le rapport cyclique), comme indiqué ci-dessous.

$$\text{Période} \geq [\text{Largeur d'impulsion} + ((\text{Temps du front montant} + \text{Temps du front descendant}) * 0,625)]$$

- Cette commande a une influence sur la période (et la fréquence) de toutes les fonctions de signaux (non seulement des impulsions). Par exemple, si vous sélectionnez une période avec la commande FUNCTION:PULSE:PERiod et que vous modifiez ensuite la fonction de sortie avec un signal sinusoïdal, la période spécifiée est utilisée pour la nouvelle fonction.
- Limitations concernant les fonctions : Si vous passez à une fonction dont la période minimale est supérieure à la valeur configurée par cette commande, la période est ajustée avec l'impulsion minimale de la nouvelle fonction. Par exemple, si vous définissez une période de 2 µs et passez ensuite à la fonction rampe, l'instrument ajuste la période à 5 µs (minimale pour les rampes). Sur l'interface distante, l'erreur « Settings conflict » est également générée.

[SOURce[1|2]:]FUNction:PULSe:TRANsition[:BOTH] {<secondes>|MINimum|MAXimum|DEFault}

[SOURce[1|2]:]FUNction:PULSe:TRANsition:LEADing {<secondes>|MINimum|MAXimum|DEFault}

[SOURce[1|2]:]FUNction:PULSe:TRANsition:LEADing? [{MINimum|MAXimum}]

[SOURce[1|2]:]FUNction:PULSe:TRANsition:TRAILing {<secondes>|MINimum|MAXimum|DEFault}

[SOURce[1|2]:]FUNction:PULSe:TRANsition:TRAILing? [{MINimum|MAXimum}]

Règle le temps du front montant, du front descendant (ou des deux) pour une impulsion.

Paramètre	Renvoi type
Série 33500 : 8,4 ns (par défaut) à 1 µs, limité comme décrit ci-dessous Série 33600 : 2,9 ns jusqu'à 4 Vpp, et 3,3 ns au-dessus de 4 Vpp à 1 µs ; limité comme indiqué ci-dessous	+1,0000000000000000E-08
Régler le temps du front montant sur 10 ns (deux méthodes) : FUNC:PULS:TRAN:LEADing 10 ns FUNC:PULS:TRAN:LEADing ,00000010	

- Le temps du front montant s'applique au front montant ; il représente le temps compris entre 10 et 90 % du front ; le temps du front descendant représente le temps entre 90 et 10 % du front.
- Le temps de front spécifié doit être contenu dans la largeur et la période d'impulsion spécifiée. L'instrument limite le temps de front afin qu'il tienne compte de la largeur d'impulsion ou du rapport cyclique spécifié pour les impulsions. Sur l'interface distante, l'erreur « Settings conflict » est également générée.

[SOURCE[1|2]:]FUNCTION:PULSE:WIDTH {<secondes>|MINimum|MAXimum|DEFAULT}

[SOURCE[1|2]:]FUNCTION:PULSE:WIDTH? [{MINimum|MAXimum}]

Configure la largeur d'impulsion.

Paramètre	Renvoi type
16 ns (série 33500), 5 ns (série 33600 jusqu'à 4 Vpp) ou 8 ns (série 33600 jusqu'à 10 Vpp) jusqu'à approximativement 1 000 000 s, limité comme décrit ci-dessous ; 100 µs par défaut	+5,000000000000000E-03
Définir la largeur d'impulsion à 5 ms (deux méthodes) : FUNC:PULS:WIDT 5 ms FUNC:PULS:WIDT ,005	

- Les commandes **FUNCTION:PULSE:DCYCLE** et **FUNCTION:PULSE:WIDTH** affectent le même paramètre. Dans certaines applications, il est naturel de régler directement la largeur d'impulsion (en secondes) ; dans d'autres, il semble plus logique de régler le rapport cyclique. Lorsque la fréquence est réglée, si la largeur d'impulsion a été réglée plus récemment que le rapport cyclique sur la face avant, le rapport cyclique demeure constant lorsque la fréquence ou la période change. Cependant, si la largeur d'impulsion était le dernier réglage, elle demeure constante lorsque la fréquence ou la période change. Reportez-vous à la commande **FUNCTION:PULSE:HOLD**.
- La largeur d'impulsion est le temps qui s'écoule entre le niveau de 50 % du front montant et le niveau de 50 % du front descendant suivant de l'impulsion.
- La largeur d'impulsion spécifiée doit également être inférieure à la différence entre la *période* et la *largeur d'impulsion minimale*, comme indiqué ci-dessous. L'instrument ajuste d'abord le temps de front de l'impulsion, puis sa largeur en fonction de la période spécifiée. Sur l'interface distante, l'erreur « Settings conflict » est également générée.

$$\text{Largeur d'impulsion} \leq \text{Période} - W_{\text{min}}$$

- La largeur d'impulsion spécifiée doit également être inférieure à la différence entre la *période* et le *temps de front*, comme indiqué ci-dessous. L'instrument ajuste d'abord le temps de front de l'impulsion, puis sa largeur en fonction de la période spécifiée. Sur l'interface distante, l'erreur « Settings conflict » est également générée.

$$\text{Largeur d'impulsion} \leq [\text{Période} - ((\text{Temps du front montant} + \text{Temps du front descendant}) * 0,625)]$$

- La largeur d'impulsion doit également être supérieure au temps total d'un front, comme indiqué ci-dessous.

$$\text{Largeur d'impulsion} \geq [(\text{Temps du front montant} + \text{Temps du front descendant}) * 0,625]$$

[SOURCE[1|2]:]FUNCTION:RAMP:SYMMetry {<pourcentage>|MINimum|MAXimum|DEFAULT}  
 [SOURCE[1|2]:]FUNCTION:RAMP:SYMMetry? [{MINimum|MAXimum}]

Définit le pourcentage de symétrie des rampes.

Paramètre	Renvoi type
0 à 100, 100 par défaut	+5,000000000000000E+01
Définir la symétrie à 50% : FUNC:RAMP:SYMM 50	

- La symétrie représente le temps cycle pendant lequel la rampe est croissante (en supposant que la polarité du signal n'est pas inversée).

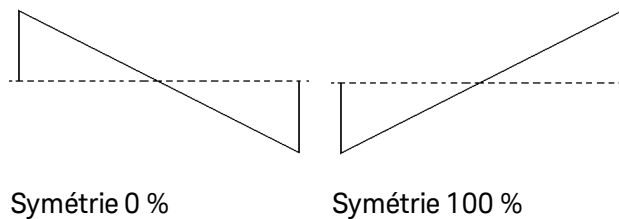

- Pour les rampes, la commande **APPLY:RAMP** remplace la symétrie active et sélectionne 100 100 %. Pour définir une symétrie différente de 100 %, sélectionnez la sortie de la rampe avec la commande **FUNCTION RAMP**, puis utilisez la commande **FUNCTION:RAMP:SYMMetry** pour configurer la symétrie.
- La symétrie est conservée lorsque vous passez d'une rampe à une autre fonction. Lorsque vous revenez à la fonction rampe, la symétrie précédente est utilisée.
- Lorsqu'une rampe est le signal modulant AM, FM, PM ou PWM, la symétrie ne s'applique pas. L'instrument utilise toujours une rampe dotée d'une symétrie de 100 %.

[SOURce[1|2]:]FUNCTioN:SQUare:DCYClE {<pourcentage>|MINimum|MAXimum}  
[SOURce[1|2]:]FUNCTioN:SQUare:DCYClE? [{MINimum|MAXimum}]

Configure le pourcentage du rapport cyclique d'un signal carré.

Paramètre	Renvoi type
0,01 à 99,99, soumis à la limitation de 16 ns sur la largeur d'impulsion minimale ; 50 par défaut	+5,000000000000000E+01
Régler le rapport cyclique sur 30% : FUNC:SQU:DCYC 30  Régler le rapport cyclique sur sa valeur minimale : FUNC:SQU:DCYC MIN	

- Le rapport cyclique représente la durée par cycle pendant laquelle le signal carré est au niveau haut (en supposant une polarité normale).
- Pour les signaux carrés, la commande **APPLy:SQUare** remplace le rapport cyclique actif par la valeur 50 %. Pour configurer un rapport cyclique différent de 50 %, sélectionnez le signal carré avec la commande **FUNCTioN SQUare**, puis utilisez la commande **FUNCTioN:SQUare:DCYClE**.
- Le rapport cyclique est conservé lorsque vous passez d'un signal carré à une autre fonction. Lorsque vous revenez au signal carré, le rapport cyclique précédent est utilisé.
- Limites imposées par la fréquence : Lorsque la fréquence augmente, les limites minimale et maximale du rapport cyclique sont ajustées pour maintenir la largeur d'impulsion minimale à 16 ns (série 33500), 5 ns (série 33600 jusqu'à 4 Vpp) ou 8 ns (série 33600 jusqu'à 10 Vpp). Par exemple, à 1 MHz, le rapport cyclique minimal sur la série 33500 est de 1,60 % et le rapport cyclique maximal est de 98,40 %. A 10 MHz, le rapport cyclique minimal est de 16,00 % et le rapport cyclique maximal de 84,00 %.
- Si vous sélectionnez un signal carré comme signal modulant pour la modulation AM, FM, PM ou PWM, l'instrument utilise toujours un signal carré avec un rapport cyclique de 50 %.

[SOURCE[1|2]:]FUNCTION:SQUare:PERiod {<secondes>|MINimum|MAXimum|DEFault}  
 [SOURCE[1|2]:]FUNCTION:SQUare:PERiod? [{MINimum|MAXimum}]

Définit la période d'un signal carré.

Paramètre	Renvoi type
De l'inverse de la <b>fréquence maximale du signal carré</b> à 1 000 000 s, 1 ms par défaut	+5,0000000000000000E-01
Définir la période à 500 ms (deux méthodes) : FUNC:SQUare:PER ,5 FUNC:SQUare:PER 500 ms	

- Limitations concernant les fonctions : Si vous passez à une fonction dont la période minimale est supérieure à la valeur configurée par cette commande, la période est ajustée avec l'impulsion minimale de la nouvelle fonction. Par exemple, si vous définissez une période de 2 µs et passez ensuite à la fonction rampe, l'instrument ajuste la période à 5 µs (minimale pour les rampes). Sur l'interface distante, l'erreur « Settings conflict » est également générée.

## Les commandes répertoriées ci-dessous nécessitent toutes l'option de lecteur IQ.

FUNCTION:ARbitrary:BALance[:STATe] {ON|1|OFF|0}

FUNCTION:ARbitrary:BALance[:STATe]?

### (Option lecteur IQ uniquement)

Active/désactive l'équilibrage des voies pour les signaux arbitraires doubles (FUNCTION:ARbitrary:BALance:GAIN et FUNCTION:ARbitrary:BALance:OFFSet).

Paramètre	Renvoi type
{ON 1 OFF 0}, OFF par défaut	0 (OFF) ou 1 (ON)
Charge un signal arbitraire à partir du lecteur et configure le gain de la balance (voie 2 réduite de 1,02 %) et les décalages de la balance (120 mV pour la voie 1 et -38 mV pour la voie 2) :	
FUNC:ARB "USB:\qam32.barb"	
FUNC:ARB:BAL:GAIN 1,02	
FUNC:ARB:BAL:OFFS1 0,12	
FUNC:ARB:BAL:OFFS2 -0,038	
FUNC:ARB:BAL ON	

- Cette fonction peut être utilisée pour compenser de légères variations des impédances des charges sur les deux voies ou des différences mineures entre les deux voies avec les informations du fichier d'origine du signal arbitraire double.
- Lorsque l'<état> est activé, les deux voies doivent rester sur la même plage d'amplification.
- Ce paramètre est enregistré dans la configuration de l'instrument et est affecté par la commande \*RST.

**FUNCTION:ARbitrary:BALance:GAIN {<pourcentage>|MINimum|MAXimum|DEFine}**  
**FUNCTION:ARbitrary:BALance:GAIN? [{MINimum|MAXimum}]**

**(Option lecteur IQ uniquement)**

Configure le rapport de balance du gain pour les signaux arbitraires doubles.

Paramètre	Renvoi type
-30 à +30	+1,02000000E+000
Charge un signal arbitraire à partir du lecteur et configure le gain de la balance (voie 2 réduite de 1,02 %) et les décalages de la balance (120 mV pour la voie 1 et -38 mV pour la voie 2) : FUNC:ARB "USB:\qam32.barb" FUNC:ARB:BAL:GAIN 1,02 FUNC:ARB:BAL:OFFS1 0,12 FUNC:ARB:BAL:OFFS2 -0,038 FUNC:ARB:BAL ON	

- Les deux voies doivent rester sur la même plage d'amplification.
- La valeur 0 signifie que les deux voies utilisent leur amplitude actuelle. Une valeur positive signifie que l'amplitude de la voie 2 est diminuée, alors que l'amplitude de la voie 1 demeure constante ; une valeur négative diminue la voie 1 alors que la voie 2 demeure constante. Pour des exemples, reportez-vous au tableau ci-dessous.

<pourcentage>	Voie 1 % amplitude	Voie 2 % amplitude
-20	80	100
-10	90	100
0	100	100
10	100	90
20	100	80

- Cette commande est activée par **FUNCTION:ARbitrary:BALance ON**.
- Ce paramètre est enregistré dans la configuration de l'instrument et est affecté par la commande **\*RST**.



**FUNCTION:ARbitrary:BALance:OFFSet{1|2} {< volts>|MINimum|MAXimum|DEFault}**

**FUNCTION:ARbitrary:BALance:OFFSet{1|2}? [MINimum|MAXimum]**

**(Option lecteur IQ uniquement)**

Spécifie la tension résiduelle (en volts) ajoutée à la tension résiduelle du signal arbitraire double pour la voie spécifiée.

Paramètre	Renvoi type
Valeur à virgule flottante, limitée par l'amplitude du signal arbitraire double.	+1,00000000E+000
Charge un signal arbitraire à partir du lecteur et configure le gain de la balance (voie 2 réduite de 1,02 %) et les décalages de la balance (120 mV pour la voie 1 et -38 mV pour la voie 2) :	
FUNC:ARB "USB:\qam32.barb"	
FUNC:ARB:BAL:GAIN 1,02	
FUNC:ARB:BAL:OFFS1 0,12	
FUNC:ARB:BAL:OFFS2 -0,038	
FUNC:ARB:BAL ON	

- Les deux voies doivent rester sur la même plage d'amplification.
- Cette commande est activée par **FUNCTION:ARbitrary:BALance ON**.
- Ce paramètre est enregistré dans la configuration de l'instrument et est affecté par la commande **\*RST**.

**FUNCTION:ARbitrary:SKEW[:STATe] {ON|1|OFF|0}**  
**FUNCTION:ARbitrary:SKEW[:STATe]?**

**(Option lecteur IQ uniquement)**

Active/désactive la compensation de la durée du déphasage (**FUNCTION:ARbitrary:SKEW:TIME**). Ce paramètre est toujours désactivé (OFF) pour les signaux modulés, les balayages, les listes et les rafales.

Paramètre	Renvoi type
{ON 1 OFF 0}, OFF par défaut	0 (OFF) ou 1 (ON)
Configurez la durée du déphasage pour compenser la voie 1 derrière la voie 2 de 140 picosecondes : FUNCTION:ARbitrary:SKEW:TIME 1,4e-10 FUNCTION:ARbitrary:SKEW ON	

- La compensation du déphasage est généralement déterminée de façon empirique, en utilisant un oscilloscope, puis en configurant une durée. Cette configuration demeure valide jusqu'à ce que l'appareil testé ou la configuration du matériel de test change.
- La valeur spécifiée par cette commande n'est pas enregistrée dans la configuration de l'instrument. Elle est enregistrée en mémoire non volatile et n'est pas affectée par la commande **\*RST**.

**FUNCTION:ARbitrary:SKEW:TIME** [{<temps>|MINimum|MAXimum|DEFault}]

**FUNCTION:ARbitrary:SKEW:TIME?** [{MINimum|MAXimum}]

### (Option lecteur IQ uniquement)

Configure une légère différence de temps entre les voies pour compenser de légères variations de synchronisation sur la sortie du connecteur ou le dispositif testé. Notez que la commande **FUNC:ARB:SKEW[:STATe] OFF** s'applique aux signaux modulés, aux balayages, aux listes et aux rafales.

Paramètre	Renvoi type
Valeur à virgule flottante dans la plage $\pm 4$ ns. Par défaut, 0.	+1,40000000E-010
Configurez la durée du déphasage pour compenser la voie 1 derrière la voie 2 de 140 picosecondes : FUNCTION:ARbitrary:SKEW:TIME 1,4e-10 FUNCTION:ARbitrary:SKEW ON	

- Les voies peuvent comporter de légères variations de synchronisation sur le connecteur de sortie du fait de variations dans les circuits internes des deux voies. De légères variations de synchronisation peuvent être observées sur le dispositif testé du fait de variations dans la propagation des signaux, y compris dans les commutateurs et les câbles.
- Une valeur positive retarde la voie 2 ; une valeur négative retarde la voie 1.
- La valeur spécifiée par cette commande n'est pas enregistrée dans la configuration de l'instrument. Elle est enregistrée en mémoire non volatile et n'est pas affectée par la commande **\*RST**.

## Sous-système HCOPY

Le sous-système HCOPY produit des copies d'écran de la face avant.

### Exemple

L'exemple suivant capture et restitue l'image sur l'écran de la face avant au format BMP.

```
HCOP:SDUM:DATA:FORM BMP
HCOP:SDUM:DATA?
```

## HCOPy:SDUMp:DATA?

Renvoie l'image affichée sur l'écran de la face avant (« copie d'écran »)

Paramètre	Renvoi type
(aucun)	<i>(Bloc binaire de longueur définie contenant l'image.)</i>  Les données en bloc de longueur définie permettent de transmettre les données dépendant d'un appareil sous forme d'un ensemble de données binaires sur 8 bits. Cela est particulièrement utile pour transférer des quantités importantes de données ou des codes étendus sur 8 bits.
Capturer et renvoyer l'image affichée : HCOP:SDUM:DATA?	

- La commande **HCOPy:SDUMp:DATA:FORMat** spécifie le format de l'image (PNG ou BMP).

## HCOPy:SDUMp:DATA:FORMat {PNG|BMP}

### HCOPy:SDUMp:DATA:FORMat?

Spécifie le format des images renvoyées par la commande **HCOPy:SDUMp:DATA?**.

Paramètre	Renvoi type
{PNG BMP}, PNG par défaut	PNG ou BMP
Définir l'image affichée au format BMP : HCOP:SDUM:DATA:FORM BMP	

## Commandes courantes IEEE-488

Ce sous-système contient les commandes et les requêtes associées aux normes IEEE-488 :

- \***CLS** - Effacer l'état
- \***ESE <valeur\_activation>** - Activer l'état des événements
- \***ESR?** - Demande du registre d'état des événements
- \***IDN?** - Identification de l'instrument
- \***OPC** - Configuration du bit de fin d'opération
- \***OPC?** - Attendre la fin de l'opération en cours
- \***OPT?** - Afficher les options installées
- \***PSC {0|1}** - Effacer l'état de l'alimentation à la mise sous tension
- \***RCL {0|1|2|3|4}** - Rappeler l'état de l'instrument
- \***RST** - Réinitialiser l'instrument avec les **réglages d'usine par défaut**
- \***SAV {0|1|2|3|4}** - Enregistrer l'état de l'instrument

**\*SRE <valeur\_activation>** - Activer les requêtes de service (activer les bits dans le registre activé du groupe du registre de l'octet d'état)

**\*STB?** - Lire l'octet d'état

**\*TRG** - Commande de déclenchement

**\*TST?** - Autotest

**\*WAI** - Attendre la fin de toutes les opérations en attente

## Registres

Certaines commandes IEEE-488 sont associées à divers registres de l'instrument, décrits ci-dessous.

### Registre des événements standard

Le tableau ci-dessous décrit le registre des événements standard.

Numéro de bit	Nom de bit	Valeur décimale	Définition
0	Opération terminée	1	Toutes les commandes précédant et incluant <b>*OPC</b> ont été exécutées.
1	(non utilisé)	2	(Réservé à une utilisation ultérieure).
2	Erreur de requête	4	L'instrument a tenté de lire la mémoire tampon de sortie, mais celle-ci était vide. Ou bien une nouvelle commande a été reçue avant de lire une requête précédente. Ou encore les deux mémoires tampon d'entrée et de sortie sont saturées.
3	Erreur spécifique à l'appareil	8	Une erreur spécifique à l'appareil, y compris une erreur d'autotest, une erreur d'étalonnage ou une autre erreur de l'appareil, s'est produite. Reportez-vous à la section <b>Messages d'erreur</b> .
4	Erreur d'exécution	16	Une erreur d'exécution s'est produite. <b>Messages d'erreur</b>
5	Commande	32	Erreur de syntaxe d'une commande. <b>Messages d'erreur</b>
6	(non utilisé)	64	(Réservé à une utilisation ultérieure).
7	Mise sous tension	128	L'alimentation a été coupée et rétablie depuis la dernière lecture ou le dernier effacement du registre des événements.

## Registre de l'octet d'état

Le tableau ci-dessous décrit le registre de l'octet d'état.

Numéro de bit	Nom de bit	Valeur décimale	Définition
0	(non utilisé)	1	(Réservé à une utilisation ultérieure).
1	(non utilisé)	2	(Réservé à une utilisation ultérieure).
2	File d'erreurs	4	Une ou plusieurs erreurs dans la file d'erreurs. Utilisez la commande <b>SYSTem:ERRor?</b> pour lire et supprimer les erreurs.
3	Récapitulatif des données suspectes	8	Un ou plusieurs bits sont activés dans le registre des données suspectes (les bits doivent être activés, voir <b>STATus:QUESTIONable:ENABLE</b> ).
4	Message Disponible	16	Des données sont disponibles dans la mémoire tampon de sortie de l'instrument.
5	Récapitulatif des événements standard	32	Un ou plusieurs bits sont activés dans le registre des événements standard (les bits doivent être activés, voir <b>*ESE</b> ).
6	Récapitulatif général	64	Un ou plusieurs bits sont activés dans le registre de l'octet d'état et peuvent entraîner une demande de service (Request for Service - RQS). Les bits doivent être activés à l'aide de la commande <b>*SRE</b> .
7	Registre de fonctionnement	128	Un ou plusieurs bits sont activés dans le registre d'état de fonctionnement. Les bits sont activés à l'aide de la commande <b>STATus:OPERation:ENABLE</b> .

### \*CLS

*Commande d'effacement de l'état.* Efface les registres des événements dans tous les groupes de registres. Efface également la file d'erreurs.

Paramètre	Renvoi type
(aucun)	(aucun)
Efface les bits du registre des événements et la file d'erreurs : *CLS	

**\*ESE <valeur\_activation>**

**\*ESE?**

Commande et requête d'activation de l'état des événements. Active les bits du **registre d'activation** du groupe **Registre des événements standard**. Les bits sélectionnés sont ensuite reportés dans le bit 5 du registre de l'octet d'état.

Paramètre	Renvoi type
Somme décimale des bits du registre (tableau ci-dessus), 0 par défaut. Par exemple, pour activer le bit 2 (valeur 4), le bit 3 (valeur 8) et le bit 7 (valeur 128), la somme décimale est égale à 140 (4 + 8 + 128). Par défaut, 0.	+48
Activer le bit 4 (valeur 16) et le bit 5 (valeur 32) dans le registre d'activation : *ESE 48	

- Utilisez la commande **\*PSC** pour déterminer si le registre d'activation des événements standard est effacé à la mise sous tension. Par exemple, la commande **\*PSC 0** conserve le contenu du registre d'activation lorsque l'instrument est remis sous tension.
- **\*CLS** n'efface que le registre des événements, pas le registre d'activation.

**\*ESR?**

Requête du registre d'état des événements standard. Recherche le groupe **Registre des événements standard** dans le registre des événements. Registre en lecture seule ; bits non effacés lorsqu'il est lu.

Paramètre	Renvoi type
(aucun)	+24
Lisez le registre des événements (bits 3 et 4 activés). *ESR	

- Une ou toutes les conditions peuvent être reportées dans le bit Récapitulatif des événements standard par le biais du registre d'activation. Pour activer le masque du registre d'activation, écrivez une valeur décimale dans le registre à l'aide de la commande **\*ESE**.
- Lorsqu'un bit est actif, il demeure dans cet état jusqu'à son effacement par cette requête ou la commande **\*CLS**.

**\*IDN?**

*Requête d'identification.* Renvoie la chaîne d'identification de l'instrument.

Paramètre	Renvoi type
(aucun)	Keysight Technologies,33522B,XXXXXXXXXX,0.179-1.19-8.88-52-00
Renvoyer la chaîne d'identification de l'instrument : *IDN?	

- La chaîne d'identification contient des champs séparés par des virgules :
  - Nom du fabricant
  - Numéro du modèle
  - Numéro de série
  - Code de la version
- La chaîne d'identification adopte le format suivant pour les instruments de la série 33500 :  
Keysight Technologies,[Model Number],[10-char Serial Number],A.aaa-B.bb-C.cc-DD-EE

**A.aaa** = version du microprogramme  
**B.bb** = version FW de la face avant  
**C.cc** = version FW du contrôleur de la face avant  
**DD** = version FPGA  
**EE** = version de la carte à circuit imprimé

- La chaîne d'identification adopte le format suivant pour les instruments de la série 33600 :  
Keysight Technologies,[Model Number],[Serial Number],A.aa.aa-B.bb-CC-DD-EE

**A.aa.aa** = version du microprogramme  
**B.bb** = version FW de la face avant  
**CC** = version de la carte mère  
**DD** = version FPGA  
**EE** = version de la carte à circuit imprimé



## \*OPC

Place le bit « Opération terminée » (bit 0) dans le registre des événements standard à la fin de l'opération en cours.

Paramètre	Renvoi type
(aucun)	(aucun)
Configurer le bit d'opération terminée : *OPC	

- Cette commande permet de synchroniser votre application avec l'instrument.
- Utilisé dans les modes balayage déclenché, rafale déclenchée, liste ou séquence de signaux arbitraires pour permettre d'interroger ou d'interrompre l'ordinateur lorsque la commande **\*TRG** ou **INITiate[:IMMEDIATE]** est terminée.
- Les autres commandes peuvent être exécutées avant que le bit Opération terminée soit positionné.
- La différence entre les commandes **\*OPC** et **\*OPC?** est que **\*OPC?** renvoie la valeur « 1 » dans la mémoire tampon de sortie lorsque l'opération est terminée. Autrement dit, aucune autre commande ne peut être envoyée après l'exécution d'une commande **\*OPC?** tant qu'elle n'a pas fourni une réponse. De cette manière, une boucle d'interrogation explicite peut être évitée. En d'autres termes, le pilote d'E/S attendra la réponse.

## \*OPC?

Renvoie la valeur 1 dans la mémoire tampon de sortie une fois toutes les commandes en attente exécutées.

Paramètre	Renvoi type
(aucun)	1
Renvoyer la valeur 1 lorsque toutes les commandes précédentes sont terminées : *OPC?	

- Cette commande permet de synchroniser votre application avec l'instrument.
- Les autres commandes ne peuvent être exécutées tant que cette commande n'est pas terminée.
- La différence entre les commandes **\*OPC** et **\*OPC?** est que **\*OPC?** renvoie la valeur « 1 » dans la mémoire tampon de sortie lorsque l'opération est terminée. Autrement dit, aucune autre commande ne peut être envoyée après l'exécution d'une commande **\*OPC?** tant qu'elle n'a pas fourni une réponse. De cette manière, une boucle d'interrogation explicite peut être évitée. En d'autres termes, le pilote d'E/S attendra la réponse.

### \*OPT?

Renvoie une chaîne de caractères entre guillemets identifiant les options installées.

Paramètre	Renvoi type
(aucun)	"0,MEM,SEC,IQP"
Renvoie les options installées (exemple : base de temps standard, mémoire étendue, sécurité, lecteur IQ) *OPT?	

### \*PSC {0|1}

#### \*PSC?

*Effacement de l'état à la mise sous tension* . Active (1) ou désactive (0) l'effacement de deux registres données à la mise sous tension :

- Registre d'activation des événements standard (\*ESE).
- Registre de condition de l'octet d'état (\*SRE).
- Registre des données suspectes
- Registre de fonctionnement standard

Paramètre	Renvoi type
{0 1}, 1 par défaut	0 ou 1
Désactiver l'effacement à la mise sous tension des registres concernés : *PSC 0	

- Ce paramètre est non volatile et n'est pas affecté par une remise sous tension. Il est par conséquent utile pour la connexion GPIB comme suit :

**\*PSC 0** pour désactiver/activer l'effacement

**\*ESE 128** pour activer l'événement de mise sous tension

**\*SRE 32** pour activer une SRQ lors d'un événement standard

Ce court programme fournit maintenant un signal GPIB SRQ lorsque l'appareil est allumé.

**\*RCL {0|1|2|3|4}**

**\*SAV {0|1|2|3|4}**

Rappelle (\*RCL) ou enregistre (\*SAV) l'état de l'instrument à un emplacement spécifié en mémoire non volatile. L'état précédemment enregistré à cet emplacement est remplacé (aucune erreur n'est générée).

**REMARQUE** Pour les instruments série 33600, les fichiers de configuration associés à \*SAV et \*RCL sont enregistrés dans des fichiers appelés STATE\_0.STA à STATE\_4.STA. Ces derniers sont situés dans le répertoire Paramètres de la mémoire interne. Vous pouvez gérer ces fichiers à l'aide des commandes **MMEMory**.

Paramètre	Renvoi type
{0 1 2 3 4}	(aucun)
Rappeler l'état à partir de l'emplacement 1 : *RCL 1	

- L'instrument comporte 4 emplacements en mémoire non volatile pour l'enregistrement des états de l'instrument. L'emplacement 0 conserve l'état de l'instrument à la coupure de l'alimentation. Utilisez les emplacements 1, 2, 3 et 4 pour enregistrer d'autres états. Vous pouvez configurer l'instrument pour rappeler l'état à la coupure de l'alimentation lorsque l'alimentation est rétablie (**MEM:STAT:REC:AUTO**).
- L'enregistrement de l'état « mémorise » la fonction sélectionnée (y compris les signaux arbitraires), la fréquence, l'amplitude, la tension résiduelle CC, le rapport cyclique, la symétrie ainsi que les paramètres de modulation utilisés. Il mémorise également l'état de la face avant (**DISP**).
- À la livraison de l'usine, les emplacements 1 à 4 sont vides et l'emplacement 0 contient l'état à la mise sous tension.
- À partir de l'interface distante SEULEMENT, vous pouvez utiliser l'emplacement 0 pour enregistrer un cinquième état de l'instrument (vous ne pouvez pas sauvegarder cet emplacement à partir de la face avant). Cependant, l'emplacement 0 est remplacé à la remise sous tension.
- Vous pouvez **attribuer un nom personnalisé** à chacun des emplacements 0 à 4.
- La commande **\*RST** n'affecte pas les états enregistrés en mémoire.
- Si vous supprimez un signal arbitraire en mémoire non volatile après avoir enregistré l'état de l'instrument, les données du signal sont perdues et l'instrument n'envoie pas le signal lorsque l'état est rappelé ; il envoie à la place l'état intégré « Croissance exponentielle ».
- La face avant utilise le **sous-système MMEMory** pour l'enregistrement des états.

## \*RST

Réinitialise l'état par défaut à la sortie d'usine de l'instrument, indépendamment du paramètre **MEMo-ry:STATe:RECall:AUTO**.

Paramètre	Renvoi type
(aucun)	(aucun)
Réinitialiser l'instrument : *RST	

- N'affecte pas les états enregistrés de l'instrument, les signaux arbitraires enregistrés ou les paramètres d'entrée/sortie ; ces éléments sont enregistrés en mémoire non volatile.
- Annule un balayage ou une rafale en cours.

## \*SRE <valeur\_activation>

### \*SRE?

Activation de demande de service. Cette commande active les bits du **registre d'activation** du groupe **Registre de l'octet d'état**.

Paramètre	Renvoi type
Somme décimale des bits du registre (tableau ci-dessus), 0 par défaut. Par exemple, pour activer le bit 2 (valeur 4), le bit 3 (valeur 8) et le bit 7 (valeur 128), la somme décimale est égale à 140 (4 + 8 + 128). Par défaut, 0.	+24
Activer les bits 3 et 4 du registre d'activation : *SRE 24	

- Pour activer des bits particuliers, spécifiez la valeur décimale correspondant à la somme binaire pondérée des bits du registre. Les bits sélectionnés sont ensuite récapitulés dans le bit 6 (Récapitulatif général) du registre de l'octet d'état. Si l'un des bits sélectionnés passe de 0 à 1, l'instrument génère un signal de demande de service.
- La commande **\*CLS** efface le registre des événements, mais pas le registre d'activation.
- La commande **\*PSC** (effacement de l'état à la mise sous tension) détermine si le registre d'activation de l'octet d'état est effacé à la mise sous tension. Par exemple, la commande **\*PSC 0** conserve le contenu du registre d'activation lorsque l'instrument est éteint puis rallumé.
- La commande n'efface pas **\*RST** le registre d'activation de l'octet d'état.

### \*STB?

*Demande de lecture de l'octet d'état.* Cette commande recherche le groupe **Registre de l'octet d'état** dans le registre de condition.

Paramètre	Renvoi type
(aucun)	+40
Lire le registre de condition (bits 3 et 5 activés) : *STB?	

- Similaire à l'interrogation série, mais traitée comme toute autre commande de l'instrument. Registre en lecture seule ; bits non effacés lorsqu'il est lu.
- Renvoie le même résultat que l'interrogation série, mais le bit « Récapitulatif général » (bit 6) n'est pas effacé par la commande \*STB?.
- La remise sous tension ou l'exécution de la commande **\*RST** entraîne l'effacement de tous les bits du registre de condition.
- Renvoie une valeur décimale qui correspond à la somme binaire pondérée de tous les bits actifs du registre. Par exemple, avec le bit 3 (valeur 8) et le bit 5 (valeur 32) activés (et les bits correspondants activés), la requête renvoie la valeur +40.

### \*TRG

*Commande de déclenchement.* Déclenche un balayage, une rafale, un saut dans un signal arbitraire ou une progression dans une liste (**LIST**) à partir de l'interface distante si la source de déclenchement du bus (logiciel) est sélectionnée (**TRIGger[1|2]:SOURce BUS**).

Paramètre	Renvoi type
(aucun)	(aucun)
Envoyer un déclenchement immédiat pour démarrer une rafale : BURS:STAT ON BURS:MODE TRIG TRIG:SOUR BUS *TRG	

## \*TST?

*Requête d'autotest.* Exécute un autotest complet de l'instrument. Si le test échoue, un ou plusieurs messages d'erreur fournissent des informations supplémentaires. Utilisez la commande **SYSTem:ERRor?** pour lire la file d'erreurs.

Paramètre	Renvoi type
(aucun)	+0 (réussite) ou +1 (échec) (un ou plusieurs tests ont échoué)
Effectuer un autotest : *TST?	

- Un autotest est effectué à la mise sous tension de l'instrument et vérifie que ce dernier fonctionne correctement.
- Un autotest complet (**\*TST?**) dure environ 15 secondes. Si tous les tests sont réussis, vous avez l'assurance que l'instrument est entièrement opérationnel.
- La commande **\*TST** affiche le message « Self-Test Passed » sur la face avant. Sinon, le message « Self-Test Failed » et un numéro d'erreur sont affichés. Pour savoir comment contacter l'assistance ou des instructions sur le retour de l'instrument à des fins de maintenance, reportez-vous à la section **Présentation des opérations d'entretien et de réparation**.

## \*WAI

Configure l'instrument afin qu'il attende la fin de toutes les opérations en attente avant d'exécuter d'autres commandes sur l'interface.

Paramètre	Renvoi type
(aucun)	(aucun)
Patienter jusqu'à la fin de toutes les opérations en attente : *WAI	

- Par exemple, vous pouvez utiliser cette option avec la commande **\*TRG** pour vous assurer que l'instrument est prêt pour un déclenchement :

```
*TRG;*WAI;*TRG
```

## Registres

L'instrument utilise trois types de registres pour activer, repérer et suivre les caractéristiques de l'instrument.

- Un registre d'activation définit les bits du registre des événements qui seront reportés dans le groupe du registre de l'octet d'état. Vous pouvez lire ou écrire dans un registre d'activation.
- Un registre de condition surveillance en permanence l'état de l'instrument. Les bits du registre de condition sont mis à jour en temps réel, et ne sont pas verrouillés ou placés en mémoire tampon.

- Un registre d'événements est un registre en lecture seule qui verrouille les divers événements du registre de condition. Il n'existe pas de mémoire tampon dans ce registre ; lorsqu'un bit d'événement est actif, les événements suivants correspondant à ce bit sont ignorés.

## Sous-système INITiate

Le sous-système INITiate contrôle la manière dont l'instrument passe de l'état « veille » à l'état « attente de déclenchement ». Vous pouvez faire cela pour une voie à la fois, ou les deux voies, avec le mot clé « ALL ».

### Exemple

Ce programme utilise la commande **INITiate[1|2]:IMMEDIATE** en association avec **TRIGger[1|2]:SOURCE** et **TRIGger[1|2]:COUNT**. La commande **TRIG:SOUR EXT** configure la voie pour le déclenchement externe et la commande **TRIG:COUNT** définit le nombre de déclenchements à la valeur 10. La commande **INITiate** place l'instrument à l'état d'attente de déclenchement. Le déclenchement se produit lorsque la ligne **Ext Trig** de la face arrière reçoit une impulsion (haute par défaut). La voie retourne à l'état inactif après 10 déclenchements. Une autre commande **INIT** est nécessaire pour reprendre l'acceptation des déclenchements sur la ligne d'entrée de déclenchement externe.

```
INIT:CONT OFF
TRIG:SOUR EXT
TRIG:COUNT 10
INIT
```

**INITiate[1|2]:CONTinuous {ON|1|OFF|0}**  
**INITiate[1|2]:CONTinuous?**

**INITiate:CONTinuous:ALL {ON|1|OFF|0}**

Indique si le système de déclenchement d'une voie ou des deux (ALL) retourne toujours à l'état d'attente de déclenchement (ON) ou s'il demeure à l'état inactif (OFF) en ignorant les déclenchements jusqu'à ce que la commande **INITiate:IMMEDIATE** soit émise.

Paramètre	Renvoi type
{ON 1 OFF 0}, ON par défaut	0 (OFF) ou 1 (ON)
Configurer les deux voies pour un déclenchement continu : INIT:CONT:ALL ON	

- Lorsque la voie est déclenchée, elle quitte l'état d'attente du déclenchement et passe dans l'état « action en cours » (par ex., rafale en cours ou balayage en cours). L'état action en cours peut durer quelque temps ; dans cet état, les déclenchements sont ignorés (non pris en compte dans le nombre de déclenchements renvoyés par la commande **TRIGger[1|2]:COUNT**).
- Avec la commande **INIT:CONT ON**, le nombre de déclenchements importe peu, car il n'existe aucun moyen de distinguer la fin d'un nombre de déclenchements du premier déclenchement du nombre de déclenchements suivant. Si vous souhaitez comptabiliser les déclenchements, vous devez exécuter la commande **INIT:CONT OFF**.



## INITiate[1|2][:IMMEDIATE]

### INITiate[:IMMEDIATE]:ALL

Fait passer le système de déclenchement des deux voies (ALL) de l'état inactif à l'état d'attente de déclenchement pour le nombre de déclenchements spécifié par la commande **TRIGger[1|2]:COUNT**.

- Lorsque la voie est déclenchée, elle quitte l'état d'attente du déclenchement et passe dans l'état « action en cours » (par ex., rafale en cours ou balayage en cours). L'état action en cours peut durer quelque temps ; dans cet état, les déclenchements sont ignorés (non pris en compte dans le nombre de déclenchements renvoyés par la commande **TRIGger[1|2]:COUNT**).

Paramètre	Renvoi type
(aucun)	(aucun)
Faire passer les deux voies à l'état d'attente de déclenchement : INIT:IMM:ALL	

- La commande **INITiate[:IMMEDIATE]** arme le système de déclenchement. Une fois le nombre de déclenchements atteint, le système de déclenchement retourne à l'état inactif et ignore les autres déclenchements. La fonction déclenchée demeure dans l'état atteint après le nombre de déclenchements. Le réarmement du système de déclenchement avec une autre commande **INITiate[:IMMEDIATE]** permet d'appliquer d'autres déclenchements.
- Utilisez la commande **ABORt** pour ramener l'instrument à l'état inactif.
- Si dans la voie spécifiée, la commande **INIT:CONT** est active (ON), les commandes **INITiate[1|2]:IMMEDIATE** et **INIT[:IMMEDIATE]:ALL** n'ont pas d'effet sur le système de déclenchement et l'erreur -213 est générée.

INPut:ATTenuation[:STATe] {ON|1|OFF|0}  
 INPut:ATTenuation[:STATe]?

Indique si l'entrée de modulation sur la série 33600 fonctionne avec des signaux jusqu'au niveau de 5 V (ON) ou le niveau 1 V (OFF).

Paramètre	Renvoi type
{ON 1 OFF 0}, ON par défaut	0 (OFF) ou 1 (ON)
Indiquer que l'entrée de modulation doit fonctionner avec des signaux jusqu'à 5 V : INP:ATT ON	

- Vous pouvez configurer ce paramètre sur l'écran des paramètres de modulation de la face avant si la source de modulation est définie sur Externe.

## Sous-système LIST

Configure la liste des fréquences que l'instrument doit envoyer. Cela permet des changements de fréquence plus rapides d'après une liste prédéterminée de fréquences. Vous pouvez faire progresser les fréquences par un déclenchement externe, interne ou un déclencheur BUS. La liste est lancée par la commande FREQUency:MODE LIST.

**LIST\_DWELL** - Définit la durée de chaque fréquence dans la liste.

**LIST\_FREQUency** - Spécifie jusqu'à 128 fréquences dans une liste (les fréquences peuvent également être lues ou enregistrées dans un fichier à l'aide des commandes MMEMory:LOAD:LIST[1|2] et MMEMory:STORe:LIST.

**LIST\_FREQUency\_POINts** - Renvoie le nombre de points dans une liste de fréquences.

Pour un exemple de programmation LIST, reportez-vous à la section [Création d'une liste de fréquences](#).

[SOURce[1|2]:]LIST:DWELL {<secondes>|MINimum|MAXimum}  
 [SOURce[1|2]:]LIST:DWELL? [{MINimum|MAXimum}]

Configure la durée des paliers de chaque fréquence dans la liste.

Paramètre	Renvoi type
1 µs à 1 000 s, 1 s par défaut	+1.2000000000000000E+01
Définir la durée des paliers sur la voie 1 à 12 s : LIST:DWEL 12	

- L'instrument génère chaque fréquence dans une liste de fréquences pour la durée des paliers spécifiée lorsque la commande TRIGger[1|2]:SOURce est IMMEDIATE.

[SOURce[1|2]:]LIST:FREQuency <fréq1>[, <fréq2>, etc.]  
[SOURce[1|2]:]LIST:FREQuency?

Indique la valeur des fréquences d'une liste.

Paramètre	Renvoi type
Liste de 1 à 128 fréquences, chacune de 1 µHz à la fréquence maximale de l'instrument (± 200 kHz pour les rampes et les signaux triangulaires). Liste par défaut : 100 Hz, 1 000 Hz et 550 Hz.	2.17800000E+006,3.14000000E+003, 6.28318000E+006
Définir la liste des fréquences de la voie 1 sur trois valeurs de fréquence : LIST:FREQ 2.718E6, 3.14E3, 6.28318E6	

- Cette commande remplace la liste précédente par la nouvelle liste.

[SOURce[1|2]:]LIST:FREQuency:POINts? [{MINimum|MAXimum}]

Renvoie le nombre de fréquences dans la liste de fréquences active.

Paramètre	Renvoi type
[{MINimum MAXimum}]	+17
Renvoyer le nombre d'entrées dans la liste des fréquences de la voie 1 : LIST:FREQ:POIN?	

- La liste par défaut comporte trois fréquences : 100 Hz, 1 000 Hz et 550 Hz.
- MINimum = 1, MAXimum = 128.

## Sous-système LXI

Le sous-système LXI prend en charge la fonctionnalité LXI (LAN eXtensions for Instrumentation).

**LXI:IDENtify[:STATE] {ON|1|OFF|0}**  
**LXI:IDENtify[:STATE]?**

Active/désactive l'affichage du voyant d'identification LXI.

Paramètre	Renvoi type
{ON 1 OFF 0}	0 (OFF) ou 1 (ON)
Activer le voyant d'identification LXI : LXI:IDEN ON	

- Ce voyant permet d'identifier le périphérique associé à l'adresse du réseau local.
- La commande **\*RST** désactive le voyant d'identification LXI.
- Appuyez sur la touche LOCAL pour désactiver le voyant d'identification LXI.

**LXI:MDNS:ENABle {ON|1|OFF|0}**  
**LXI:MDNS:ENABle?**

Active/désactive le système mDNS (Multicast Domain Name System).

Paramètre	Renvoi type
{ON 1 OFF 0}, ON par défaut	0 (OFF) ou 1 (ON)
Activer mDNS : LXI:MDSN:ENAB ON	

- Ce paramètre est activé après la commande **SYSTem:SECurity:IMMEDIATE**, **\*RST**, la mise sous tension ou la réinitialisation du réseau local.

**LXI:MDNS:HNAME[:RESolved]?**

Renvoie le nom d'hôte mDNS résolu (unique) au format *<mDNS Hostname>-N*. *N* est un entier ajouté en cas de besoin pour différencier ce nom des autres. Le nom souhaité peut être tronqué si nécessaire afin de libérer de l'espace pour l'entier ajouté.

Paramètre	Renvoi type
(aucun)	« A-335xxx-00107 », où xxx correspond aux 3 derniers caractères du numéro du modèle et 00107 aux 5 derniers chiffres du numéro de série.
Renvoyer le nom d'hôte mDNS résolu : LXI:MDNS:HNAME:RESolved?	

**LXI:MDNS:SNAME:DESired <nom>**

**LXI:MDNS:SNAME:DESired?**

Définit le nom du service mDNS souhaité.

Paramètre	Renvoi type
Chaîne de caractères entre guillemets comportant jusqu'à 63 caractères, Keysight par défaut <Nom_modèle> Générateur de signaux arbitraires - <Numéro_série>".	« Keysight 335xxx Arbitrary Waveform Generator - 99999 », où xxx correspond aux 4 derniers caractères du numéro du modèle et 99999, aux 5 derniers chiffres du numéro de série.
Définir le nom de service mDNS comme « Générateur de signaux » : LXI:MDNS:SNAME:DES « Générateur de signaux »	

- Ce paramètre est non volatile ; il n'est pas modifié par une remise sous tension ou l'exécution de la commande **\*RST**.
- Ce paramètre est défini à la valeur par défaut après la commande **SYSTEM:SECURITY:IMMEDIATE**.

**LXI:MDNS:SNAME[:RESolved]?**

Renvoie le nom du service mDNS résolu (unique) au format <Nom de service mDNS souhaité>(N). N est un entier ajouté en cas de besoin pour différencier ce nom des autres. Le nom souhaité peut être tronqué si nécessaire afin de libérer de l'espace pour l'entier ajouté.

Paramètre	Renvoi type
(aucun)	« Keysight 335xxx Arbitrary Waveform Generator - 99999 », où xxx correspond aux 4 derniers caractères du numéro du modèle et 99999, aux 5 derniers chiffres du numéro de série.
Renvoyer le nom du service mDNS résolu : LXI:MDNS:SNAME:RESolved?	

- Le nom du service mDNS résolu est le nom de service souhaité (**LXI:MDNS:SNAME:DESired**), parfois avec « (N) » à la fin, où N est un entier, uniquement si le nom doit être unique.

## LXI:RESet

Réinitialise les paramètres réseau à un état connu, en commençant par DHCP. Si DHCP échoue, il utilise AutoIP. Efface également le mot de passe WebUI, si celui-ci est défini.

Paramètre	Renvoi type
(aucun)	(aucun)
Réinitialiser les paramètres du réseau local : LXI:RES	

- En fonction de votre réseau, le redémarrage de l'interface du réseau local peut durer plusieurs secondes après l'envoi de cette commande.
- Si l'interface réseau ou des services donnés (VXI-11, sockets, etc.) sont désactivés par la commande SYSTem:COMMunicate:ENABLE, vous devez réactiver séparément l'interface ou les services et remettre l'instrument sous tension afin que le réseau local fonctionne correctement.

## LXI:REStart

Redémarre le réseau local avec les paramètres actifs spécifiés par les commandes SYSTem:COMM:LAN.

Paramètre	Renvoi type
(aucun)	(aucun)
Redémarrer l'interface du réseau local : LXI:REST	

- En fonction de votre réseau, le redémarrage de l'interface du réseau local peut durer plusieurs secondes après l'envoi de cette commande.
- Si l'interface réseau ou des services donnés (VXI-11, sockets, etc.) sont désactivés par la commande SYSTem:COMMunicate:ENABLE, vous devez réactiver séparément l'interface ou les services et remettre l'instrument sous tension afin que le réseau local fonctionne correctement.

## Sous-système MARKer

Le sous-système MARKer configure le point d'un signal arbitraire, d'un balayage ou d'une rafale auquel le signal **Sync** de la face avant passe au niveau bas.

### Commandes et requêtes

- [SOURce[1|2]:]MARKer:CYCle {<num\_cycle>|MINimum|MAXimum|DEFault} - cycle d'une rafale auquel le signal **Sync** passe au niveau bas
- [SOURce[1|2]:]MARKer:FREQuency {<fréquence>|MINimum|MAXimum|DEFault} - fréquence à laquelle le signal **Sync** passe au niveau bas
- [SOURce[1|2]:]MARKer:POINt {<nombre\_échantillons>|MINimum|MAXimum} - point d'un signal arbitraire auquel le signal **Sync** passe au niveau bas

Si et seulement si SYNC:MODE est défini sur MARKer, chacune de ces commandes provoque le passage de la synchronisation/du marqueur au niveau haut au début d'une rafale, d'un balayage ou d'un signal arbitraire. La commande **OUTPut:SYNC:POLarity** peut inverser cette action.

**[SOURce[1|2]:]MARKer:CYCLe {<num\_cycle>|MINimum|MAXimum|DEFAULT}**  
**[SOURce[1|2]:]MARKer:CYCLe? [{MINimum|MAXimum}]**

Définit le nombre de cycles du marqueur auquel le signal **Sync** de la face avant passe au niveau bas en mode rafale. La commande **OUTPut:SYNC:POLarity** peut inverser cette action.

Paramètre	Renvoi type
Nombre entier compris entre 2 et le nombre de cycles de la rafale augmenté d'une unité (NCYCles+1) ; 2 par défaut	+2,000000000000000E+03
Définir le cycle du marqueur à la valeur 2 000 : MARK:CYCL 2000	

- Valide uniquement si la rafale est activée et si **OUTP:SYNC:MODE** est MARKer.
- Lorsque la rafale est activée, le cycle du marqueur doit être inférieur ou égal au nombre de cycles de la rafale augmenté d'une unité. Une tentative de placer le cycle du marqueur en dehors de cette plage place le cycle au centre de la rafale. Sur l'interface distante, l'erreur « Settings conflict » est également générée.

**[SOURce[1|2]:]MARKer:FREQuency {<fréquence>|MINimum|MAXimum|DEFAULT}**  
**[SOURce[1|2]:]MARKer:FREQuency? [{MINimum|MAXimum}]**

Définit la fréquence du marqueur à laquelle le signal **Sync** de la face avant passe au niveau bas pendant un balayage. La commande **OUTPut:SYNC:POLarity** peut inverser cette action.

Paramètre	Renvoi type
Toute fréquence comprise entre les fréquences initiale et finale ; 500 Hz par défaut	+2,000000000000000E+03
Régler la fréquence du marqueur sur 2 kHz : MARK:FREQ 2000	

- Valide uniquement si le balayage est activé et si **OUTP:SYNC:MODE** est MARKer.
- Lorsque le mode balayage est activé, la fréquence du marqueur doit être comprise entre les fréquences initiale et finale. Une tentative de placer le cycle du marqueur en dehors de cette plage place la fréquence du marqueur à la fréquence initiale ou finale (la plus proche). Sur l'interface distante, l'erreur « Settings conflict » est également générée.

[SOURce[1|2]:]MARKer:POINt {<nombre\_échantillons>|MINimum|MAXimum}  
[SOURce[1|2]:]MARKer:POINt? [{MINimum|MAXimum}]

Définit le nombre d'échantillons auquel le signal **Sync** de la face avant passe au niveau bas dans le signal arbitraire actif. La commande **OUTPut:SYNC:POLarity** peut inverser cette action.

Paramètre	Renvoi type
Nombre entier compris entre 4 et le nombre d'échantillons dans le signal diminué de 3 ; le point par défaut est le point médian du signal arbitraire	+1,000000000000000E+01
Configurer le point du marqueur au 10e échantillon du signal : MARK:POIN 10	

- La commande place le point du marqueur uniquement dans le signal arbitraire actif (**FUNCTION:ARbitrary**), non dans une séquence.
- Cette commande est uniquement valide dans les conditions suivantes :
  - **OUTPut:SYNC:MODE** défini sur MARK, **FUNC** défini sur ARB, **FREQuency:MODE** défini sur CW
  - **OUTPut:SYNC:MODE** défini sur CARR, **FUNC** défini sur ARB, **BURSt ON**.
  - **OUTPut:SYNC:MODE** défini sur CARR, **FUNC** défini sur ARB, **FREQuency:MODE** défini sur SWEEP
  - **OUTPut:SYNC:MODE** défini sur MARK, modulation interne active et, **FUNCTION** défini sur ARB ou fonction interne d'un signal modulant définie sur ARB
  - **OUTPut:SYNC:MODE** défini sur MARK, modulation externe active et **FUNCTION** défini sur ARB

## Sous-système MEMory

Le sous-système MEMory fonctionne avec les fichiers de configuration de l'instrument qui sont enregistrés dans (**\*SAV**) et rappelés depuis des emplacements de stockage non volatiles (**\*RCL**) numérotés de 0 à 4.

**REMARQUE** Pour les instruments série 33600, les fichiers de configuration associés à \*SAV et \*RCL sont enregistrés dans des fichiers appelés STATE\_0.STA à STATE\_4.STA. Ces derniers sont situés dans le répertoire Paramètres de la mémoire interne. Vous pouvez gérer ces fichiers à l'aide des commandes **MMEMory**.

## Exemple

```
MEM:STAT:DEL 3
*SAV 3
MEM:STAT:VAL? 3
MEM:STAT:NAME 3,PATS_STATE
MEM:STAT:CAT?
```



## Commandes et requêtes

- **MEMory:NSTates?** - renvoie le nombre total d'emplacements d'enregistrement des états
- **MEMory:STATe:CATalog?** - répertorie les noms associés aux 5 emplacements d'enregistrement des états
- **MEMory:STATe:DElete {0|1|2|3|4}** - supprime le contenu d'un emplacement d'enregistrement d'état
- **MEMory:STATe:NAME {0|1|2|3|4} [, <nom>]** - attribue un nom personnalisé à un emplacement d'enregistrement d'état
- **MEMory:STATe:RECall:AUTO {ON|1|OFF|0}** - indique si l'état à la coupure de l'alimentation est rappelé de l'emplacement mémoire 0 à la mise sous tension
- **MEMory:STATe:VALid? {0|1|2|3|4}** - détermine si un emplacement mémoire contient un état valide

### MEMory:NSTates?

Renvoie le nombre total d'emplacements mémoire disponibles pour l'enregistrement des états (toujours +5, y compris l'emplacement 0).

Paramètre	Renvoi type
(aucun)	+5
Renvoyer le nombre d'emplacements d'enregistrement des états : MEM:NST?	

### MEMory:STATe:CATalog?

Renvoie les noms attribués aux emplacements 0 à 4.

Paramètre	Renvoi type
(aucun)	"AUTO_RECALL","STATE_1","STATE_2","STATE_3","STATE_4"
Renvoyer les noms des emplacements : MEM:STAT:CAT?	

- Les noms par défaut sont : « AUTO\_RECALL », « STATE\_1 », « STATE\_2 », « STATE\_3 » et « STATE\_4 ».
- Vous pouvez attribuer un nom à l'emplacement 0. Cependant, ce nom est remplacé lorsque l'alimentation est coupée puis rétablie et une nouvelle configuration à l'extinction est enregistrée ici.

## MEMory:STATe:DELeTe {0|1|2|3|4}

Supprime un emplacement d'enregistrement des états.

Paramètre	Renvoi type
{0 1 2 3 4}	(aucun)
Supprimer le contenu de l'emplacement 1 : MEM:STAT:DEL 1	

- Les noms par défaut sont : « AUTO\_RECALL », « STATE\_1 », « STATE\_2 », « STATE\_3 » et « STATE\_4 ».
- Bien que vous puissiez supprimer l'état à l'emplacement 0, l'instrument est rétabli à son état d'extinction lors de la prochaine mise sous tension.
- Toute tentative de rappel d'un état à partir d'un emplacement vide génère une erreur.

## MEMory:STATe:NAME {0|1|2|3|4}[,<nom>]

### MEMory:STATe:NAME? {0|1|2|3|4}

Attribue un nom à l'emplacement d'enregistrement.

Paramètre	Renvoi type
Chaîne sans guillemets contenant jusqu'à 12 caractères. Le premier caractère doit être une lettre (A-Z) Les autres caractères peuvent être des lettres, des chiffres (0 à 9) ou le caractère de soulignement (« _ »). Si le nom n'est pas précisé, le nom configuré par défaut en usine est utilisé.	TEST_RACK_1
Attribuer un nouveau nom à l'emplacement 1 : MEM:STAT:NAME 1,TEST_RACK_1	

- Les noms par défaut sont : « AUTO\_RECALL », « STATE\_1 », « STATE\_2 », « STATE\_3 » et « STATE\_4 ».
- Vous pouvez attribuer un nom à l'emplacement 0. Cependant, ce nom est remplacé lorsque l'alimentation est coupée puis rétablie et une nouvelle configuration à l'extinction est enregistrée ici.
- Peut attribuer le même nom à différents emplacements.
- La suppression du contenu d'un emplacement (**MEMory:STATe:DELeTe**) entraîne la réinitialisation du nom associé au nom par défaut configuré en usine (« AUTO\_RECALL », « STATE\_1 », « STATE\_2 », « STATE\_3 » ou « STATE\_4 »).
- La commande **\*RST** n'affecte pas les noms des états.

**MEMory:STATe:RECall:AUTO {ON|1|OFF|0}**

**MEMory:STATe:RECall:AUTO?**

Désactive/active le rappel automatique de l'état de l'instrument dans l'emplacement mémoire « 0 » à la mise sous tension.

Paramètre	Renvoi type
{ON 1 OFF 0}, ON par défaut	0 (OFF) ou 1 (ON)
Désactiver le rappel automatique de l'état à la coupure de l'alimentation : MEM:STAT:REC:AUTO OFF	

- OFF est équivalent à la réinitialisation des réglages d'usine (**\*RST**) à la mise sous tension.

**MEMory:STATe:VALid? {0|1|2|3|4}**

Indique si un état valide est enregistré à un emplacement mémoire actif.

Paramètre	Renvoi type
{0 1 2 3 4}	0 (état enregistré non valide) ou 1 (état enregistré valide)
Renvoyer l'état de l'emplacement mémoire 3 : MEM:STAT:VAL 3?	

- Utilisez cette commande avant de passer la commande **\*SAV** pour éviter de remplacer accidentellement un état.

## Sous-système MMEMory

Le sous-système MMEMory gère le système de fichiers de l'instrument ou d'un périphérique USB externe. Le système de fichiers peut enregistrer et charger plusieurs formats de fichiers.

Le système de fichiers en mémoire flash « INT:\ » de l'instrument est toujours présent. Si un périphérique de stockage USB (parfois appelé lecteur flash ou clé USB) est branché dans le port USB de la face avant, il se présente sous la forme s'affiche sous la forme « USB:\ » sur l'instrument.

### Exemple

Le code suivant génère la séquence illustrée ci-dessous. Notez que la commande **DATA:SEQuence** longue est répartie sur plusieurs lignes pour une meilleure lisibilité.

```
FUNC:ARB:SRATE 10E3
FUNC:ARB:FILTER OFF
FUNC:ARB:PTPEAK 10
DATA:ARB dc_ramp, 0.1, 0.1, 0.1, 0.1, 0.1, 0.2, 0.4, 0.6, 0.8, 1.0
DATA:ARB dc5v, 1.0, 1.0, 1.0, 1.0, 1.0, 1.0, 1.0, 1.0, 1.0, 1.0
DATA:ARB dc2_5v, 0.5, 0.5, 0.5, 0.5, 0.5, 0.5, 0.5, 0.5, 0.5, 0.5
DATA:ARB dc0v, 0.0, 0.0, 0.0, 0.0, 0.0, 0.0, 0.0, 0.0, 0.0, 0.0
DATA:SEQuence #3128"seqExample", "dc_ramp", 0, on-
ce, highAtStart, 5, "dc5v", 2, repeat, maintain, 5,
    "dc2_v", 2, repeat, lowAtStart, 5, "dc0v", 2, repeat, maintain, 5
FUNC:ARB dc_ramp
MMEM:STORE:DATA "INT:\dc_ramp.arb"
FUNC:ARB dc5v
MMEM:STORE:DATA "INT:\dc5v.arb"
FUNC:ARB dc2_5v
MMEM:STORE:DATA "INT:\dc2_5.arb"
FUNC:ARB dc0v
MMEM:STORE:DATA "INT:\dc0v.arb"
FUNC:ARB seqExample
MMEM:STORE:DATA "INT:\seqExample.seq"
DATA:VOL:CLEAR <--- erase all waveforms to show LOAD will restore all wave-
forms
MMEM:LOAD:DATA "INT:\seqExample.seq"
FUNC ARB
FUNC:ARB "INT:\seqExample.seq"
OUTPUT ON
```

Le fichier seqExample.seq se présente comme suit :

```
File Format:1.10
Sample Rate:10000,000000
High Level:5,000000
Low Level:0,000000
Filter:"off"
Header:Arb Name, Repeat Count, Play Control,Marker Mode, Marker Point
dc_ramp.arb,1,"once","highAtStart",5
dc5v.arb,2,"repeat","maintain",5
dc2_5v.arb,2,"repeat","lowAtStart",5
dc0v.arb,2,"repeat","maintain",5
```

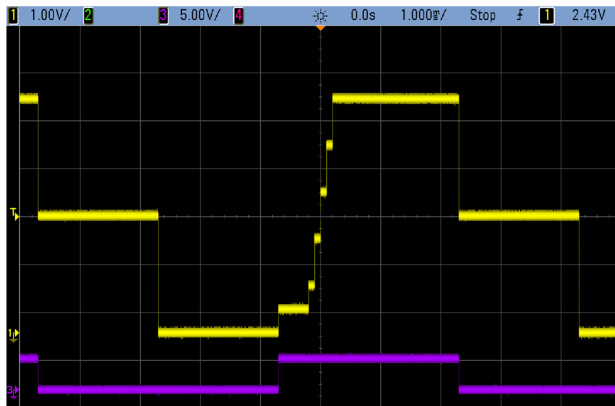

## Commandes et requêtes

Le sous-système MMEMory comprend les commandes et requêtes suivantes.

**MMEMory:CATalog[:ALL]? [*<dossier>*]** - renvoie l'espace utilisé et disponible et les fichiers sur le périphérique de mémoire de masse

**MMEMory:CATalog:DATA:ARbitrary? [*<dossier>*]** - répertorie les signaux arbitraires et les séquences sur le périphérique de mémoire de masse

**MMEMory:CATalog:STATe? [*<dossier>*]** - renvoie l'espace utilisé et disponible et les fichiers d'état (\*.sta) présents sur le périphérique de mémoire de masse

**MMEMory:CDIRectory *<dossier>*** - bascule vers un répertoire

**MMEMory:CDIRectory?**

**MMEMory:COpy *<fichier 1>*,*<fichier 2>*** - copie un fichier sur le périphérique de mémoire de masse

**MMEMory:COpy:SEQuence *<source>*,*<destination>*** - copie une séquence et les signaux arbitraires associés sur le périphérique de mémoire de masse

**MMEMory:DELeTe *<fichier>*** - supprime des fichiers du périphérique de mémoire de masse

**MMEMory:DOWNload:DATA *<bloc\_binaire>*** - télécharge des données de l'ordinateur hôte dans la mémoire de masse de l'instrument

**MMEMory:DOWNload:FNAME *<nom de fichier>*** - spécifie le nom du fichier pour le téléchargement des données de l'ordinateur dans la mémoire de masse de l'instrument

**MMEMory:LOAD:ALL *<nom de fichier>*** - charge le fichier de configuration de l'instrument

**MMEMory:LOAD:DATA[1|2] *<nom de fichier>*** - charge le signal arbitraire à partir du fichier

**MMEMory:LOAD:LIST[1|2] *<nom de fichier>*** - charge la liste de fréquences à partir du fichier

**MMEMory:LOAD:STATe *<nom de fichier>*** - charge la configuration de l'instrument enregistrée à partir du fichier

**MMEMory:MDIRectory *<dossier>*** - crée un répertoire (dossier)

**MMEMory:MOVE *<fichier 1>*,*<fichier 2>*** - déplace un fichier sur le périphérique de mémoire de masse

**MMEMory:RDIRectory *<dossier>*** - supprime un répertoire

**MMEMory:STORe:ALL *<nom de fichier>*** - enregistre le fichier de configuration de l'instrument

**MMEMory:STORe:DATA[1|2] *<nom de fichier>*** - enregistre le signal arbitraire dans un fichier

**MMEMory:STORe:LIST[1|2] *<nom de fichier>*** - enregistre la liste de fréquences active dans un fichier

**MMEMory:STORe:STATe *<nom de fichier>*** - enregistre la configuration de l'instrument dans un fichier

**MMEMory:UPLoad? *<nom de fichier>*** - télécharge le contenu d'un fichier de l'instrument vers l'ordinateur hôte

## Formats des dossiers et des fichiers

De nombreuses commandes MMEMory font référence à des dossiers et à des fichiers. Leurs structures particulières sont décrites ci-dessous.

### Format d'un <dossier>

- Le format d'un <dossier> est « <lecteur>:<chemin> », où <lecteur> peut être INTernal ou USB et <chemin> correspond au chemin d'accès complet au dossier.
  - INTernal spécifie le système de fichiers flash interne. USB désigne un périphérique de stockage USB sur la face avant.
  - Les chemins d'accès absolus commencent par « \ » ou « / » au dossier racine <lecteur>.
  - Le nom de dossier spécifié dans <chemin> ne peut pas contenir plus de 240 caractères.
  - Le dossier spécifié doit exister, et ne peut pas être masqué ou un dossier système.
  - Si <lecteur>:<chemin> n'est pas indiqué, le dossier spécifié par la commande **MMEMory:CDIRectory** est utilisé.
  - Si <drive> n'est pas indiqué :
    - Le chemin d'accès est traité comme un chemin relatif et ajouté au dossier spécifié par la commande **MMEMory:CDIRectory**.
    - Les chemins absolus NE SONT PAS autorisés.

### Format d'un <fichier>

- Le format de <fichier1> et de <fichier2> est « [<lecteur>:<chemin>]<nom\_fichier> », où <lecteur> peut être INTernal ou USB, et <chemin> doit être le chemin d'accès complet au dossier.
  - INTernal spécifie le système de fichiers flash interne. USB désigne un périphérique de stockage USB sur la face avant.
  - Si <lecteur>:<chemin> n'est pas indiqué, le dossier spécifié par la commande **MMEMo-ry:CDIRectory** est utilisé.
  - Les chemins d'accès absolus commencent par « \ » ou « / » au dossier racine <lecteur>.
  - Les noms de dossiers et de fichiers ne peuvent pas contenir les caractères suivants : \ / : \* ? " < > |
  - La combinaison du nom du dossier et du fichier ne peut pas contenir plus de 240 caractères.
  - Le fichier et le dossier d'origine et le dossier de destination doivent exister, et ne peuvent pas être masqués ou des fichiers/dossiers système.
  - Si le fichier de destination existe, il est remplacé, sauf s'il est masqué ou s'il s'agit d'un fichier système.
  - Si <drive> n'est pas indiqué :
    - Le chemin d'accès est traité comme un chemin relatif et ajouté au dossier spécifié par la commande **MMEMory:CDIRectory**.
    - Les chemins absolus NE SONT PAS autorisés.

### Mémoire de masse (MMEMory) et enregistrement de l'état

La face avant utilise le sous-système MMEM, et non le sous-système MEM, pour enregistrer les états. Si vous enregistrez un état sur la face avant, vous pouvez néanmoins y accéder avec le langage SCPI. Cependant, il n'est pas possible de récupérer à partir de la face avant un état enregistré dans le sous-système MEM via SCPI au moyen de la commande \*SAV.

Par exemple, configurez l'instrument comme vous le souhaitez et introduisez une clé USB dans la face avant. Entrez ensuite les commandes suivantes. Si vous n'avez pas de clé USB, modifiez « USB:\ » à « INT:\ » pour utiliser la mémoire flash interne de l'instrument.

```
MMEMory:CDIRectory "USB:\"  
MMEMory:MDIRerctory "States"  
MMEMory:STORE:STATE "USB:\States\State1"
```

Pour retourner à cet état à tout moment :

```
MMEMory:LOAD:STATE "USB:\States\State1"
```

Vous pouvez également rappeler un fichier de configuration à partir du panneau avant en appuyant sur **[System] > Store/Recall**.



## MMEMory:CATalog[:ALL]? [<dossier>]

Renvoie une liste de tous les fichiers dans le répertoire actif de la mémoire de masse, y compris la mémoire interne et la clé USB.

Paramètre	Renvoi type
Nom de dossier valide ; par défaut, dossier sélectionné par la commande <b>MMEMory:CDIRectory</b>	+1000000000,+327168572, "command.exe,,375808", "MySetup.sta,STAT,8192", "MyWave.csv,ASC,11265"
Répertorier tous les fichiers dans le dossier MyData de la mémoire de masse USB de la face avant : MMEM:CAT? "USB:\MyData"	

- Le catalogue adopte le format suivant :

<mém\_utilisée>,<mém\_disponible>{,<liste\_fichiers>"}

L'appareil renvoie deux valeurs numériques et une chaîne de caractères pour chaque fichier dans le dossier. La première valeur numérique indique le nombre d'octets de mémoire utilisés sur le lecteur. La deuxième valeur indique le nombre d'octets de mémoire disponibles. Chaque <liste de fichier> répond au format « <nom\_fichier>,<type\_fichier>,<taille\_fichier> » (les guillemets sont également renvoyés), où <nom\_fichier> correspond au nom du fichier avec son extension ; <type\_fichier> est STAT pour les fichiers STATE (.sta), ASC pour les fichiers de données (.csv), FOLD pour des dossiers ou vide pour les autres extensions ; <taille\_fichier> représente la taille des fichiers en octets.

- S'il n'existe pas de fichier, seules les valeurs <mém\_utilisée> et <mém\_disponible> sont renvoyées.
- Du fait que l'instrument utilise une faible quantité d'espace dans le système de fichiers pour l'utilisation interne, la valeur <mém\_utilisée> n'est pas nulle, même s'il n'existe pas de fichiers utilisateur sur le lecteur.

## MMEMory:CATalog:DATA:ARbitrary? [<dossier>]

Renvoie une liste de tous les fichiers et dossiers de séquences arbitraires (.seq), ainsi que des fichiers de signaux arbitraires (.arb/.barb) dans un dossier.

Paramètre	Renvoi type
Nom de dossier valide ; par défaut, dossier sélectionné par la commande <b>MMEMory:CDIRectory</b>	(voir ci-dessous)
La requête suivante répertorie tous les fichiers de signaux arbitraires et de séquences dans le répertoire BuiltIn de la mémoire interne.	
<pre>MMEM:CAT:DATA:ARbitrary? "INT:\BuiltIn"</pre>	
Réponse type : 96256,1019770880,"EXP_RISE.arb,ARB,1868","EXP_FALL.arb,ARB,2064", "SINC.arb,ARB,1897","CARDIAC.arb,ARB,2410","NEG_RAMP.arb,ARB,1908", "HAVERSINE.arb,ARB,374","GAUSSIAN.arb,ARB,587","LORENTZ.arb,ARB,1254", "D_LORENTZ.arb,ARB,1373"	

- L'instrument renvoie 2 valeurs numériques et une chaîne de caractères pour chaque fichier .seq et .arb/.barb dans le dossier sélectionné. La première valeur numérique indique le nombre d'octets de mémoire utilisés sur le lecteur. La deuxième valeur indique le nombre d'octets de mémoire disponibles. Chaque <liste de fichiers> répond au format « <nom de fichier>,<type\_fichier>,<taille\_fichier> » (les guillemets sont également renvoyés), où <nom de fichier> correspond au nom de fichier avec son extension ; <type\_fichier> est FOLD pour les dossiers, ARB pour les segments arbitraires ou SEQUENCE pour les fichiers de séquences arbitraires ; <taille\_fichier> représente la taille des fichiers en octets.
- S'il n'existe pas de fichier .seq, .arb ou .barb, seules les valeurs <mém\_utilisée> et <mém\_disponible> sont renvoyées.
- Du fait que l'instrument utilise une faible quantité d'espace dans le système de fichiers pour l'utilisation interne, la valeur <mém\_utilisée> n'est pas nulle, même s'il n'existe pas de fichiers utilisateur sur le lecteur.

## MMEMory:CATalog:STATe? [<dossier>]

Répertorie tous les fichiers d'état (extension .sta) dans un dossier.

Paramètre	Renvoi type
Nom de dossier valide ; par défaut, dossier sélectionné par la commande <b>MMEMo-ry:CDIRectory</b>	+1000000000,+327168572,"MySetup.sta,STAT,8192"
Répertorier tous les fichiers d'état dans le dossier MyData de la clé USB de la face avant : MMEM:CAT:STAT? "USB:\MyData"	

- Format du catalogue renvoyé :

<mém\_utilisée>,<mém\_disponible>{"<liste\_fichiers>"}

- L'instrument renvoie 2 valeurs numériques et une chaîne de caractères pour chaque fichier d'état dans le dossier sélectionné. La première valeur numérique indique le nombre d'octets de mémoire utilisés sur le lecteur. La deuxième valeur indique le nombre d'octets de mémoire disponibles. Chaque <liste de fichiers> répond au format « <nom\_fichier>,<type\_fichier>,<taille\_fichier> » (les guillemets sont également renvoyés), où <nom\_fichier> correspond au nom du fichier avec son extension ; <type\_fichier> est STAT pour les fichiers d'état (.sta) ; <taille\_fichier> est la taille des fichiers en octets.
- S'il n'existe aucun fichier, seules les valeurs <mém\_utilisée> et <mém\_disponible> sont renvoyées.
- Du fait que l'instrument utilise une faible quantité d'espace dans le système de fichiers pour l'utilisation interne, la valeur <mém\_utilisée> n'est pas nulle, même s'il n'existe pas de fichiers utilisateur sur le lecteur.

**MMEMory:CDIRectory <dossier>**

**MMEMory:CDIRectory?**

**MMEMory:MDIRectory <dossier>**

**MMEMory:RDIRectory <dossier>**

MMEMory:CDIRectory sélectionne le dossier par défaut des commandes du sous-système MMEMory. Ce dossier doit exister ; il est utilisé lorsque les noms des dossiers ou des fichiers ne contiennent pas de nom de dossier ou de fichier.

MMEMory:MDIRectory crée un répertoire (dossier) sur le support de mémoire de masse.

MMEMory:RDIRectory supprime un répertoire (dossier) sur le support de mémoire de masse.

Paramètre	Renvoi type
Nom de répertoire contenant le nom du périphérique de mémoire de masse ; par défaut INT:\	« INT:\ »
Créer et supprimer un répertoire nommé « test » sur le système de mémoire de masse interne : MMEM:MDIR "test" MMEM:RDIR "test"  Renvoyer le dossier par défaut pour les commandes du sous-système MMEMory : MMEM:CDIR?	

- L'instrument réinitialise le dossier par défaut avec le répertoire racine du système de fichiers interne (« INT:\ ») après la commande **\*RST**.
- Vous pouvez supprimer uniquement un dossier vide (sans fichiers). Sinon, l'instrument génère l'erreur « Directory not empty ».

**MMEMory:COPY <fichier 1>,<fichier 2>**

Copie <fichier1> vers <fichier2>. Les noms de fichiers doivent inclure une extension.

Paramètre	Renvoi type
Les deux fichiers peuvent porter n'importe quel nom valide.	(aucun)
Copier le fichier de configuration MyFreqMeas.sta du répertoire racine vers le dossier « Backup » du système de fichiers flash interne. MMEM:COPY "INT:\MySetup.sta","INT:\Backup"	

- Pour copier un fichier dans un fichier du même nom dans un dossier différent, vous pouvez spécifier uniquement le <lecteur> et/ou le <chemin> de la <destination>.

### MMEMory:COpy:SEQuence <source>,<destination>

Copie une séquence de <source> vers <destination>. Les noms de fichiers doivent inclure une extension. Utilisez l'extension .seq pour le format texte.

Paramètre	Renvoi type
<source> et <destination> peuvent avoir n'importe quel nom de séquence valide.	(aucun)
Copie le fichier de séquence MySequence.seq et tous les fichiers de segments associés dans le fichier de séquence du lecteur interne dans le dossier « Backup » de la mémoire de masse interne. MMEM:COpy:SEQ "INT:\MySequence.seq", "INT:\Backup"	

- Le format de <source> et <destination> est « [[<lecteur>:]<chemin>]<nom\_fichier> », où <lecteur> peut être INTERNAL ou USB et <chemin> est le chemin d'accès à un fichier.
  - INTERNAL spécifie le système de fichiers flash interne. USB désigne un périphérique de stockage USB sur la face avant.
  - Si <lecteur> est spécifié, <chemin> est interprété comme un chemin d'accès absolu. Les chemins d'accès absolus commencent par « \ » ou « / » au dossier racine <lecteur>.
  - Si <lecteur> n'est pas fourni, <chemin> désigne le dossier spécifié par la commande MMEMo-ry:CDIRectory. Les chemins relatifs ne doivent pas commencer par « \ » ou « / ».
  - Les noms de dossiers et de fichiers ne peuvent pas contenir les caractères suivants : \ / : \* ? " < > |
  - La combinaison du nom du dossier et du fichier ne peut pas contenir plus de 240 caractères.
  - Le fichier et le dossier d'origine et le dossier de destination doivent exister, et ne peuvent pas être masqués ou des fichiers/dossiers système.
  - Si le fichier de destination existe, il est remplacé, sauf s'il est masqué ou s'il s'agit d'un fichier système.
  - Pour copier un fichier de séquence dans un fichier de séquence du même nom dans un dossier différent, vous pouvez spécifier uniquement le <lecteur> et/ou le <chemin> pour la <destination>.

### MMEMory:DELeTe <fichier>

Supprime un fichier. Pour supprimer un dossier, utilisez la commande MMEMory:RDIRectory.

Paramètre	Renvoi type
Tout nom de fichier valide, avec l'extension de fichier.	(aucun)
Supprimer le fichier indiqué du répertoire racine du système de fichiers flash interne : MMEM:DEL "INT:\MySetup.sta"	

- Vous pouvez également utiliser des caractères génériques avec cette commande. Par exemple, MMEM:DEL "INT:\MYDATA\\*.csv" efface tous les fichiers CSV dans le répertoire spécifié.

### **MMEMory:DOWNload:DATA < bloc\_binaire >**

Télécharge des données de l'ordinateur hôte dans un fichier de l'instrument. Le nom de fichier doit avoir été préalablement spécifié par la commande **MMEMory:DOWNload:FNAME**.

Les données du < bloc\_binaire > sont écrites dans le fichier sélectionné ; toutes les données précédemment enregistrées dans le fichier sont perdues.

<b>Paramètre</b>	<b>Renvoi type</b>
Tout bloc IEEE-488 de taille définie ou indéfinie	(aucun)
Écrit le mot « Hello » dans le fichier « \Myfile » de la mémoire interne. MMEM:DOWN:FNAME "INT:\Myfile" MMEM:DOWN:DATA #15Hello	

### **MMEMory:DOWNload:FNAME < nom de fichier >**

Crée ou ouvre le nom du fichier spécifié avant d'y écrire des données à l'aide de la commande **MMEMory:DOWNload:DATA**.

<b>Paramètre</b>	<b>Renvoi type</b>
Tout nom de fichier valide	(aucun)
Écrire le mot « Hello » dans le fichier « \Myfile » sur le système de fichiers flash interne : MMEM:DOWN:FNAME "INT:\Myfile"MMEM:DOWN:DATA #15Hello	

### **MMEMory:LOAD:ALL <nom de fichier>**

### **MMEMory:STORe:ALL <nom de fichier>**

Charge ou enregistre une configuration complète de l'instrument à l'aide d'un fichier nommé dans la mémoire de masse.

<b>Paramètre</b>	<b>Renvoi type</b>
Tout nom de fichier valide dans le répertoire actif de la mémoire de masse	(aucun)
Enregistrer la configuration de l'instrument dans le fichier « completeSetup.all » de la mémoire interne : MMEM:STOR:ALL "INT:\completeSetup.all"  Charge une configuration complète de l'instrument à partir du fichier de la mémoire de masse interne. MMEM:LOAD:ALL "INT:\completeSetup.all"	

- Ces commandes permettent de dupliquer l'état antérieur d'un instrument.
- Cette commande charge la configuration actuelle de l'instrument (utilisée par \*SAV et \*RCL).
- Les fichiers de configuration de l'instrument utilisés par ces commandes contiennent plus de données que les fichiers d'état utilisés par les commandes \*SAV et \*RCL. Ils contiennent également des états et des signaux arbitraires enregistrés, les paramètres réseau et GPIB, le format des nombres, l'activation/désactivation du signal sonore, les options d'affichage et la langue de l'aide.
- Si le fichier de destination existe, il est remplacé, sauf s'il est masqué ou s'il s'agit d'un fichier système.

### **MMEMory:LOAD:DATA[1|2] <nom de fichier>**

Charge le segment arbitraire (.arb/.barb) ou la séquence arbitraire (.seq) spécifié en mémoire interne (INTERNAL) ou USB dans la mémoire volatile de la voie spécifiée.

<b>Paramètre</b>	<b>Renvoi type</b>
Tout nom de fichier valide, comme décrit ci-dessous.	(aucun)
Charger un segment de signal arbitraire du lecteur interne dans la mémoire volatile de la voie 1 et le sélectionner pour utilisation. MMEM:LOAD:DATA "Int:\Builtin\HAVERSINE.arb" FUNC:ARB "Int:\Builtin\HAVERSINE.ARB"	

- Si un fichier de séquence (.seq) est spécifié, tous les signaux arbitraires définis dans ce fichier sont chargés.
- Si le signal référencé par <nom de fichier> a déjà été chargé, l'instrument génère l'erreur +786 « Specified arb waveform already exists ». Pour supprimer un signal existant, il faut effacer la mémoire non volatile des signaux à l'aide de la commande **DATA:VOLatile:CLEar**.

**MMEMory:LOAD:LIST[1|2] <nom de fichier>**

**MMEMory:STORe:LIST[1|2] <nom de fichier>**

Charge ou enregistre un fichier de liste de fréquences (.lst).

Paramètre	Renvoi type
Tout nom de fichier valide sur le périphérique de mémoire de masse	(aucun)
Enregistrer la liste des fréquences active dans un fichier LIST de la mémoire interne : MMEM:STOR:LIST "INT:\FreqList.lst"	
Charger un fichier LIST dans le système interne de mémoire de masse (fichier appelé FreqList.lst). MMEM:LOAD:LIST "INT:\FreqList.lst"	

- Une liste de fréquences contrôle la fréquence dans **FREQ:MODE LIST**, en passant rapidement à la fréquence suivante de la liste lorsqu'un événement de déclenchement est reçu.
- Un fichier de liste de fréquences contient une série de nombres ASCII séparés par des virgules, le premier nombre indiquant le nombre de fréquences de la liste :  
3, 100.000000, 1000.000000, 550.000000
- Si le fichier de destination existe, il est remplacé, sauf s'il est masqué ou s'il s'agit d'un fichier système.

**MMEMory:LOAD:STATe <nom de fichier>**

**MMEMory:STORe:STATe <nom de fichier>**

Enregistre la configuration actuelle de l'instrument dans un fichier d'état. Le nom de fichier inclut éventuellement le nom du dossier et l'extension .sta.

Paramètre	Renvoi type
Tout nom de fichier valide dans le répertoire actif	(aucun)
Enregistrer l'état actuel de l'appareil dans le fichier de configuration MyFreqMeas.sta du répertoire racine du système de fichiers flash interne : MMEM:STOR:STAT "INT:\MySetup"	
Charger l'état de l'instrument à partir du fichier MySetup.sta situé dans le répertoire racine de la mémoire interne. MMEM:LOAD:STAT "INT:\MySetup.sta"	



## MMEMory:MOVE <fichier 1>,<fichier 2>

Déplace et/ou renomme <fichier1> en <fichier2>. Les noms de fichiers doivent comporter l'extension.

Paramètre	Renvoi type
Les deux fichiers peuvent porter n'importe quel nom valide.	(aucun)
Déplacer le fichier de configuration MySetup.sta du répertoire par défaut actuellement sélectionné vers le dossier « Backup » du système de fichiers flash interne : MMEM:MOVE "MySetup.sta", "INT:\Backup"  Renommez le signal arbitraire arbMonday sur le lecteur USB à arbTuesday. MMEM:MOVE "USB:\arbMonday", "USB:\arbTuesday"	

- Pour renommer simplement un fichier, spécifiez le même dossier pour <fichier1> et <fichier2>.
- Pour déplacer un fichier vers un fichier du même nom dans un autre dossier, vous pouvez spécifier uniquement <lecteur>:<chemin> pour <fichier2>.

## MMEMory:STOR:DATA[1|2] <nom de fichier>

Enregistre le segment arbitraire (.arb/.barb) ou les données de séquence arbitraire (.seq) spécifié dans la mémoire volatile de la voie (par défaut, voie 1) en mémoire interne (INTERNAL) ou USB.

Paramètre	Renvoi type
Tout nom de fichier valide	(aucun)
Enregistrer une séquence arbitraire chargée en mémoire volatile sur la voie 1 du lecteur interne. MMEM:STOR:DATA "INT:\Sequence1.seq"	

- Lorsque vous enregistrez un segment ou une séquence de signal arbitraire (**MMEMory:STOR:DATA [1|2]**), les réglages actuels de l'instrument (tensions, fréquence d'échantillonnage, type de filtre, etc.) sont enregistrés dans le fichier du segment ou de la séquence. Lorsque vous lisez le fichier pour la première fois avec la commande **FUNCtion:ARbitrary**, ces paramètres sont chargés et remplacent les réglages actuels de l'instrument. Si vous avez modifié manuellement le fichier d'un segment ou d'une séquence en supprimant les paramètres de l'instrument, les réglages de l'instrument ne sont pas modifiés lorsque vous exécutez la commande **FUNCtion:ARbitrary**.
- Si le fichier de destination existe, il est remplacé, sauf s'il est masqué ou s'il s'agit d'un fichier système.
- Si un fichier de séquence de signaux arbitraires (.seq) est spécifié, tous les noms des fichiers de segments de signaux arbitraires associés à la séquence sont enregistrés dans ce fichier.
- La commande génère une erreur si le segment ou la séquence spécifié ne se trouve pas en mémoire volatile.

## MMEMory:UPLoad? <nom de fichier>

Télécharge le contenu d'un fichier de l'instrument vers l'ordinateur hôte.

Paramètre	Renvoi type
Tout nom de fichier valide	Bloc IEEE 488.2 de longueur définie
La commande suivante télécharge le contenu du fichier d'état « Myfile.sta » dans le répertoire racine du système de fichiers flash interne dans l'ordinateur hôte : MMEM:UPL? "INT:\Myfile.sta"	

## Sous-système OUTPut

Le sous-système OUTPut contrôle la sortie de la voie et les connecteurs **Sync** de la voie de la face avant, ainsi que le connecteur **Ext Trig** de la face arrière :

- **OUTPut[1|2]{ON|1|OFF|0}** - état du connecteur de sortie de la voie sur la face avant
- **OUTPut[1|2]:LOAD {<ohms>|INFinity|MINimum|MAXimum|DEFault}** - impédance de sortie
- **OUTPut[1|2]:MODE {NORMal|GATed}** - mode de sortie de la voie
- **OUTPut[1|2]:POLarity {NORMal|INVerted}** - polarité du signal de sortie
- **OUTPut:SYNC {ON|1|OFF|0}** - état du connecteur **Sync** de la face avant
- **OUTPut[1|2]:SYNC:MODE?** - mode du signal de synchronisation
- **OUTPut[1|2]:SYNC:POLarity {NORMal|INVerted}** - polarité du signal de synchronisation
- **OUTPut:SYNC:SOURce {CH1|CH2}** - voie utilisée pour commander le signal de synchronisation
- **OUTPut:TRIGger {ON|1|OFF|0}** - état du connecteur **Ext Trig** de la face arrière
- **OUTPut:TRIGger:SLOPe {POSitive|NEGative}** - polarité du signal de sortie du déclenchement (« trigger out »)
- **OUTPut:TRIGger:SOURce {CH1|CH2}** - voie de commande du déclenchement en sortie

**OUTPut[1|2] {ON|1|OFF|0}**  
**OUTPut[1|2]?**

Active/désactive le connecteur de sortie de la face avant.

Paramètre	Renvoi type
{ON 1 OFF 0}, OFF par défaut	0 (OFF) ou 1 (ON)
Active le connecteur de sortie de la voie 1 : OUTP ON	

- Lorsque la sortie est activée, la touche de sortie de la voie de la face avant s'allume.
- Les commandes **APPLY** remplacent le paramètre OUTPut actif et activent le connecteur de sortie de la voie.
- Si une tension externe trop élevée est appliquée au connecteur de sortie de la voie de la face avant, un message d'erreur s'affiche et la sortie est désactivée. Pour réactiver la sortie, supprimez la surcharge sur le connecteur de sortie et activez la voie (OUTPut ON).
- OUTPut change l'état du connecteur de sortie de la voie en commutant le relais de sortie, sans annuler la tension de sortie. Par conséquent, la sortie peut être instable pendant environ une milliseconde jusqu'à ce que le signal se stabilise. Minimisez cette instabilité en minimisant d'abord l'amplitude (**VOLTage MIN**) et en réglant la tension résiduelle à 0 (**VOLTage:OFFSet 0**) avant de modifier l'état de la sortie.
- Cette commande alterne également l'impédance de sortie entre 50  $\Omega$  (ON) et une impédance élevée (>1 M $\Omega$ ) (OFF).

**OUTPut[1|2]:LOAD {<ohms>|INFinity|MINimum|MAXimum|DEFault}**  
**OUTPut[1|2]:LOAD? [{MINimum|MAXimum}]**

Configure l'impédance de sortie attendue. Doit être égal à l'impédance de la charge connectée à la sortie.

Paramètre	Renvoi type
1 Ω à 10 kΩ, 50 Ω par défaut	+5,0000000000000000E+02
Régler l'impédance de sortie sur 300 Ω : OUTP:LOAD 300  Régler l'impédance de sortie sur « haute impédance » : OUTP:LOAD INF	

- La valeur spécifiée est utilisée pour l'amplitude, la tension résiduelle et les niveaux haut/bas.
- L'instrument comporte un ensemble constant d'impédances de sortie de 50 Ω sur les connecteurs de la face avant. Si l'impédance de charge réelle diffère de la valeur spécifiée, l'amplitude et les niveaux de décalage affichés seront incorrects. Le réglage de l'impédance de la charge est simplement un moyen pratique de garantir que la tension affichée correspond à la charge attendue.
- Si vous modifiez le réglage de l'impédance de sortie, l'amplitude de sortie, la tension résiduelle et les niveaux haut/bas affichés sont ajustés (aucune erreur n'est générée). Si l'amplitude est de 10 Vpp et si vous modifiez la terminaison de sortie de 50 Ω à « haute impédance » (**OUTPut[1|2]:LOAD INF**), l'amplitude double pour atteindre 20 Vpp. Toute modification de la « haute impédance » à 50 Ω réduit de moitié l'amplitude affichée. L'impédance de sortie n'affecte pas la tension de sortie réelle. Elle modifie uniquement les valeurs affichées et récupérées de l'interface distante. La tension de sortie réelle varie en fonction de la charge connectée.
- Vous ne pouvez pas spécifier l'amplitude de sortie en dBm si la terminaison de sortie est réglée sur une impédance élevée. Les unités sont automatiquement converties en Volts crête/crête (Vpp). Pour plus d'informations, reportez-vous à la commande **VOLT:UNIT**.
- Vous ne pouvez pas modifier l'impédance de sortie lorsque des limites de tension sont actives du fait que l'instrument ne peut pas savoir à quelle impédance ces limites s'appliquent. Pour modifier l'impédance de sortie, désactivez les limites de tension, configurez la nouvelle valeur d'impédance, ajustez les limites de tension et réactivez-les.
- Si INF (haute impédance) est sélectionné, la requête renvoie 9.9E+37.

**OUTPut[1|2]:MODE {NORMAl|GATed}**  
**OUTPut[1|2]:MODE?**

Active (GATed) ou désactive (NORMAl) le contrôle du signal de sortie à l'aide de l'entrée de déclenchement.

Paramètre	Renvoi type
{ NORMAl GATed }, NORMAl par défaut	GAT ou NORM
Activer la sortie commandée : OUTP:MODE GAT	

- L'effet du déclenchement ne dépend en aucun cas de la phase ou de la synchronisation du signal. Lorsque l'entrée de déclenchement est évaluée, le signal de sortie est généré. Lorsque le déclenchement n'est pas évalué, le signal continue à être généré en interne, mais il n'est pas envoyé au connecteur de sortie de la voie.
- Le déclenchement ne modifie pas l'impédance de sortie de la voie (n'actionne pas le relais de sortie).

**OUTPut[1|2]:POLarity {NORMAl|INVerted}**  
**OUTPut[1|2]:POLarity?**

Inverse le signal par rapport à la tension résiduelle.

Paramètre	Renvoi type
{ NORMAl INVerted }, NORMAl par défaut	NORM ou INV
Régler la polarité de sortie sur INVerted : OUTP:POL INV	

- **NORMAl** : le signal se déplace dans un sens au début du cycle ;
- **INVerted** : le signal se déplace dans l'autre sens.
- Le signal ci-dessous est inversé par rapport à la tension résiduelle. La tension résiduelle ne change pas lorsque le signal est inversé.

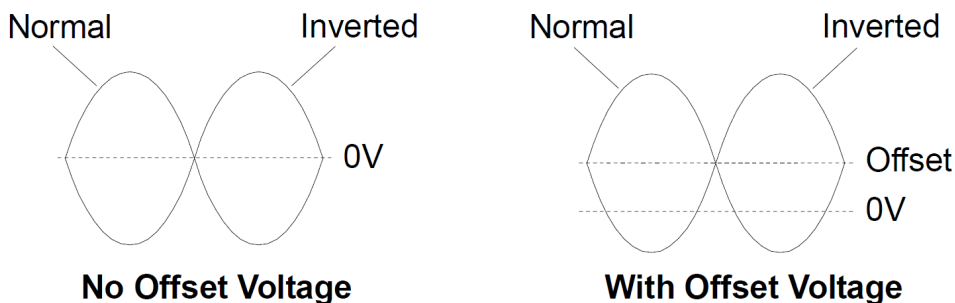

- Le signal **Sync** associé à un signal inversé n'est pas inversé.

**OUTPut:SYNC {ON|1|OFF|0}**

**OUTPut:SYNC?**

Active/désactive le connecteur **Sync** de la face avant.

Paramètre	Renvoi type
{ON 1 OFF 0}, ON par défaut	0 (OFF) ou 1 (ON)
Désactiver le connecteur <b>Sync</b> de la face avant : OUTP:SYNC OFF	

- La désactivation du signal **Sync** réduit la déformation de la sortie à des amplitudes inférieures.
- Pour plus d'informations sur le signal **Sync** de chaque fonction de signal, reportez-vous à la section [Signal de sortie de synchronisation](#).
- Lorsque le signal **Sync** est désactivé, le niveau de sortie sur le connecteur **Sync** est en logique « basse ».
- L'inversion d'un signal (voir [OUTPut\[1|2\]:POLarity INV](#)) n'entraîne pas celle du signal **Sync**.

**OUTPut[1|2]:SYNC:MODE {NORMal|CARRier|MARKer}**

**OUTPut[1|2]:SYNC:MODE?**

Spécifie le comportement normal du connecteur **Sync** (NORMal), force le signal **Sync** à suivre le signal porteur (CARRier) ou indique la position du marqueur (MARKer).

Paramètre	Renvoi type
{NORMal CARRier MARKer}, NORMal par défaut	NORM, CARR ou MARK
Configurer le mode de synchronisation de sortie sur CARRier : OUTPut:SYNC:MODE CARR	

- Le tableau suivant détaille le comportement de la commande :

<mode>	Comportement du signal Sync	Conditions
NORMal	Le signal Sync suit l'enveloppe du signal de rafale.	Lorsque le mode BURSt est activé
	Le signal Sync suit l'enveloppe du signal de balayage.	Lorsque le mode SWEEp est activé
	Le signal Sync suit le signal modulant.	Lorsque la source modulante et de modulation est interne
	Le signal Sync suit le signal FUNC.	Toutes les autres conditions
CARRier	Le signal Sync suit le réglage SOURce:MARKer:POINT actuel.	Lorsque le mode BURSt ou SWEEp est activé et que FUNC est configuré sur ARB
	Le signal Sync suit la fonction FUNC lorsque la rafale est active.	Lorsque le mode BURSt est activé et que FUNC n'est pas configuré sur ARB
	Le signal Sync suit le signal FUNC.	Toutes les autres conditions

<b>&lt;mode&gt;</b>	<b>Comportement du signal Sync</b>	<b>Conditions</b>
MARKer	Le signal Sync suit le réglage SOURce:MARKer:POINt actuel.	En mode CW et FUNC configuré sur ARB  Lorsque la source modulante et de modulation est interne et FUNC est configuré sur ARB ou <modulation>:INT:FUNC est configuré sur ARB  Lorsque la source modulante et de modulation est externe et que FUNC est configuré sur ARB
	Le signal Sync suit le réglage SOURce:MARKer:CYCLE actuel.	Lorsque le mode BURST est activé
	Le signal Sync suit le réglage SOURce:MARKer:FREQuency actuel.	Lorsque le mode SWEEP est activé
	Le signal Sync suit le signal modulant.	Lorsque la source modulante et de modulation est externe et FUNC n'est pas configuré sur ARB et INT:FUNC n'est pas configuré sur ARB
	Le signal Sync suit le signal FUNC.	Toutes les autres conditions

OUTPut[1|2]:SYNC:POLarity {NORMal|INVerted}

OUTPut[1|2]:SYNC:POLarity?

Configure la polarité de sortie désirée de la sortie **Sync** pour déclencher du matériel externe qui peut nécessiter des déclenchements sur front montant ou descendant.

<b>Paramètre</b>	<b>Renvoi type</b>
{NORMal INVerted}, NORMal par défaut	NORM ou INV
Configurer le connecteur de synchronisation de la sortie de l'instrument pour un comportement normal : OUTP:SYNC:POL NORM	

- **NORMal** : la tension sur le connecteur de sortie **Sync** est pratiquement nulle et augmente lorsqu'un événement de synchronisation **Sync** se produit. La tension demeure élevée (environ 3,3 V avec une connexion haute impédance) jusqu'à ce que le signal **Sync** ne soit pas évalué lorsqu'il rechute à une valeur pratiquement nulle.
- **INVerted** : inverse de NORMal.
- Le signal **Sync** peut être dérivé de n'importe quelle voie d'un instrument 2 voies (OUTPut:SYNC:SOURce) et de plusieurs mode de fonctionnement du signal **Sync** (OUTPut:SYNC:MODE).



**OUTPut:SYNC:SOURce {CH1|CH2}**

**OUTPut:SYNC:SOURce?**

Configure la source du connecteur de sortie **Sync**.

<b>Paramètre</b>	<b>Renvoi type</b>
{CH1 CH2}, CH1 par défaut	CH1 ou CH2
Régler la source de synchronisation sur la voie 2 : OUTP :SYNC:SOUR CH2	

**OUTPut:TRIGger {ON|1|OFF|0}**

**OUTPut:TRIGger?**

Active/désactive le signal de sortie du déclenchement (« trigger out ») en mode balayage et rafale.

Paramètre	Renvoi type
{ON 1 OFF 0}, OFF par défaut	0 (OFF) ou 1 (ON)
Activer le signal de sortie de déclenchement : OUTP:TRIG ON	

- Lorsqu'il est activé, une impulsion avec le sens de front spécifié (**OUTPut:TRIGger:SLOPe**) est envoyée du connecteur **Ext Trig** de la face arrière au début de la rafale ou du balayage.
- En mode rafale déclenchée :
  - Avec la commande **TRIGger[1|2]:SOURce IMMEDIATE**, l'instrument envoie un signal carré doté d'un rapport cyclique de 50 % à partir du connecteur **Ext Trig**. La période du signal est égale à la période de la rafale (**BURSt:INTernal:PERiod**).
  - Avec la commande **TRIGger[1|2]:SOURce EXTernal** ou **BURSt:MODE GAT**, l'instrument désactive le signal de sortie du déclenchement. Le connecteur **Ext Trig** de la face arrière ne peut pas être utilisé simultanément pour les deux opérations (le balayage à déclenchement externe utilise le même connecteur pour déclencher le balayage ou la rafale).
  - Avec la commande **TRIGger[1|2]:SOURce BUS**, l'instrument envoie une impulsion (largeur de >1 µs sur la série 33500 et de 100 ns sur la série 33600) à partir du connecteur **Ext Trig** au début de chaque balayage ou rafale.
- En mode balayage de fréquence :
  - Avec la commande **TRIGger[1|2]:SOURce IMMEDIATE**, l'instrument envoie un signal carré doté d'un rapport cyclique de 50 % (le front montant est le déclencheur du balayage) à partir du connecteur **Ext Trig**. La période du signal est égale au temps de balayage (**SWEep:TIME**).
  - Avec la commande **TRIGger[1|2]:SOURce EXTernal**, l'instrument désactive le signal de sortie du déclenchement. Le connecteur **Ext Trig** de la face arrière ne peut pas être utilisé simultanément pour les deux opérations (le balayage à déclenchement externe utilise le même connecteur pour déclencher le balayage).
  - Avec la commande **TRIGger[1|2]:SOURce BUS**, l'instrument envoie une impulsion (largeur de >1 µs sur la série 33500 et de 100 ns sur la série 33600) à partir du connecteur **Ext Trig** au début de chaque balayage ou rafale.

**OUTPut:TRIGger:SLOPe {POSitive|NEGative}**

**OUTPut:TRIGger:SLOPe?**

Détermine si l'instrument utilise le front montant ou descendant pour le signal de sortie du déclenchement.

Paramètre	Renvoi type
{ POSitive NEGative}, POSitive par défaut	POS ou NEG
Régler la pente de déclenchement sur NEGative (front descendant) : OUTP:TRIG:SLOP NEG	

- POSitive envoie une impulsion avec front montant ; NEGative envoie une impulsion avec front descendant.
- Lorsqu'il est activé avec la commande OUTPut:TRIGger, une impulsion avec le sens spécifié pour le front est envoyée à partir du connecteur **Trig Out** de la face arrière au début d'un balayage ou d'une rafale.

**OUTPut:TRIGger:SOURce {CH1|CH2}**

**OUTPut:TRIGger:SOURce?**

Sélectionne la voie source utilisée par la sortie de déclenchement sur un instrument 2 voies. La voie source détermine le signal de sortie à générer sur le connecteur de sortie du déclenchement.

Paramètre	Renvoi type
{ CH1 CH2}, CH1 par défaut	CH1 ou CH2
Régler la source de déclenchement de sortie sur CH2 : OUTP:TRIG:SOUR CH2	

- Dans un instrument 2 voies, toute voie peut servir de voie source pour la sortie du déclenchement, mais la voie 2 n'est pas valide pour les signaux (IQ) arbitraires doubles.

## Sous-système PHASe

Le sous-système PHASe permet d'ajuster la phase d'un signal ; il est utile dans les applications entre voies et entre voie et synchronisation. Ce sous-système permet également d'utiliser les connecteurs **10 MHz Out** et **10 MHz In** de la face arrière pour synchroniser plusieurs instruments.

- **[SOURce[1|2]:]PHASe {<angle>|MINimum|MAXimum|DEFault}** : configure la phase du signal de sortie (non disponible pour les signaux arbitraires ou le bruit)
- **[SOURce[1|2]:]PHASe:ARBitrary {<angle>|MINimum|MAXimum}** : configure la tension résiduelle du signal arbitraire actuellement sélectionné
- **[SOURce[1|2]:]PHASe:MODulation {<angle>|MINimum|MAXimum}** : définit la phase de la source de modulation interne lors de la modulation par la source interne

- **[SOURce[1|2]:]PHASe:REFerence** : configure un nouveau point de référence de phase nulle sans modifier la sortie de l'instrument
- **[SOURce[1|2]:]PHASe:SYNChronize** : synchronise les phases des deux voies internes d'un instrument 2 voies.
- **[SOURce[1|2]:]PHASe:UNLock:ERRor:STATe {ON|1|OFF|0}** : indique si l'instrument produit une erreur en cas de perte du verrouillage des phases

**[SOURce[1|2]:]PHASe {< angle>|MINimum|MAXimum|DEFault}**

**[SOURce[1|2]:]PHASe? [{MINimum|MAXimum}]**

Configure l'angle de déphasage du signal.

Paramètre	Renvoi type
-360 à +360 degrés, $-2\pi$ à $+2\pi$ radians, ou -(période) à +(période), comme indiqué par la commande <b>UNIT:ANGLe</b> . Par défaut, 0.	+1,5000000000000E+01
Configurer le déphasage de la voie 1 sur 15 degrés : UNIT:ANGL DEG PHAS 15	

- Le déphasage est indépendant de la phase de rafale (**BURSt:PHASe**).
- Cette commande ne modifie pas le générateur de phase principale de la voie ; elle ajoute simplement un déphasage.
- Cette commande est également utile pour modifier la relation des phases entre les voies dans un instrument 2 voies et entre la voie et son signal de synchronisation.
- Dans un instrument 2 voies, utilisez la commande **PHASe:SYNChronize** pour synchroniser les phases des deux voies internes. Chaque voie conserve son déphasage en courant, mais les deux voies ont un point de référence commun de façon à déterminer le déphasage entre les voies.
- Lors de la synchronisation des phases de plusieurs instruments (**commandes ROSC**), la commande de phase permet d'ajuster la relation des phases entre les instruments.

**[SOURce[1|2]:]PHASe:ARbitrary {<angle>|MINimum|MAXimum}**  
**[SOURce[1|2]:]PHASe:ARbitrary?**

Configure la tension résiduelle du signal arbitraire actuellement sélectionné en degrés, radians, secondes ou échantillons. Les unités par défaut du paramètre <angle> sont définies par la commande UNIT:ARbitrary:ANGLE.

**REMARQUE** Cette commande s'applique uniquement à la série 33600 et aux signaux arbitraires d'au moins 64 échantillons.

Paramètre	Renvoi type
De -360 à 360 (DEGree) De -2π à 2π (RADian) De la période de signal arbitraire - à la période de signal arbitraire + (SECond) De -(nombre d'échantillons-1) à +(nombre d'échantillons - 1) (SAMPle)	+3,000000000000000E+01
UNIT:ARB:ANGL DEG PHAS:ARB 30	

- Ce paramètre affecte uniquement la phase du signal arbitraire actuellement sélectionné. Pour d'autres fonctions, reportez-vous à la section [\[SOURce\[1|2\]:\]PHASe](#).
- Ce paramètre affecte la phase du signal du signal arbitraire en mode continu normal, du mode de modulation et du mode de balayage. En mode rafale, la phase du signal arbitraire est déterminée par la commande [\[SOURce\[1|2\]BURSt:PHASe](#).
- Lorsqu'un signal arbitraire est chargé en mémoire, sa phase initiale est égale à zéro ; il n'hérite pas de la phase du signal arbitraire actuellement sélectionné. Chaque signal arbitraire conserve son propre réglage de phase en mémoire.
- La phase du signal arbitraire est définie par rapport à l'ensemble des points contenus dans l'enregistrement des signaux arbitraires. Par exemple, le réglage de la phase du signal arbitraire sur 180 degrés sur un signal arbitraire de 64 échantillons entraîne une rotation de la lecture du signal de sorte qu'il démarre (comme indiqué par le signal de synchronisation) au 33<sup>e</sup> échantillon et se termine au 32<sup>e</sup> échantillon.

[SOURce[1|2]:]PHASe:MODulation {<angle>|MINimum|MAXimum}

[SOURce[1|2]:]PHASe:MODulation?

Règle la phase de la source de modulation interne lors de la modulation par la source interne avec la forme SIN, SQU, RAMP, NRAMp ou TRI. Cette commande s'applique uniquement à la série 33600.

**REMARQUE** Cette commande s'applique uniquement à la série 33600 et aux signaux arbitraires d'au moins 64 échantillons.

Paramètre	Renvoi type
De -360 à 360 (DEGree) De -2π à 2π (DEGree) De la période de signal arbitraire - à la période de signal arbitraire + (SECond)	+3,000000000000000E+01
Définir la phase de modulation sur 30 degrés : UNIT:ANGL DEG PHAS:MOD 30	

- Les unités par défaut du paramètre <angle> sont définies par la commande UNIT:ANGL.

[SOURce[1|2]:]PHASe:REFerence

Supprime simultanément le déphasage configuré par la commande PHASe et règle de générateur de la phase principale selon une quantité équivalente au paramètre PHASe. Cela conserve la relation configurée avec un autre instrument tout en resynchronisant le signal de synchronisation avec la sortie.

Paramètre	Renvoi type
(aucun)	(aucun)
Réinitialiser le point de référence de phase nulle de la voie 1 : PHAS:REF	

- Le principal objectif de cette commande est d'établir un point de déphasage nul entre deux instruments connectés. Pour un fonctionnement intervoie sur un instrument 2 voies, utilisez la commande PHASe:SYNChronize.
- La configuration d'un point de référence de phase nulle signifie que la valeur renvoyée ultérieurement par la requête PHASe? est réinitialisée à « 0 », mais que le signal de sortie ne change pas.

## [SOURce[1|2]:]PHASe:SYNChronize

Réinitialise simultanément tous les générateurs de phase de l'instrument, y compris les générateurs de phase de modulation pour établir un point commun interne de référence de phase nulle. Cette commande n'affecte pas le paramètre PHASe des voies ; elle établit simplement un déphasage entre les voies comme somme de SOUR1:PHAS et SOUR2:PHAS au lieu d'une valeur arbitraire.

Paramètre	Renvoi type
(aucun)	(aucun)
Réinitialiser tous les générateurs de phase : PHAS:SYNC	

- SOURce1 et SOURce2 n'ont pas d'importance pour cette commande.
- Cette commande annule la relation de phase avec un autre instrument du fait qu'elle réinitialise les générateurs de phase.
- Dans les instruments 1 voie, elle synchronise la voie principale avec le générateur interne de modulation.
- Vous pouvez configurer la phase entre le signal principal et le signal **SUM** en envoyant la commande **SOURce[1|2]:PHASe:SYNChronize** après avoir configuré les fonctions du signal principal et du signal **SUM**. Sinon, la phase entre les deux signaux est arbitraire.

## [SOURce[1|2]:]PHASe:UNLock:ERRor:STATe {ON|1|OFF|0}

### [SOURce[1|2]:]PHASe:UNLock:ERRor:STATe?

Active/désactive la production d'une erreur si un verrouillage de phase est perdu par la base de temps de l'instrument. L'instrument utilise une base de temps pour les deux voies.

Paramètre	Renvoi type
{ON 1 OFF 0}, OFF par défaut	0 (OFF) ou 1 (ON)
Activer la génération d'erreurs de verrouillage de phase : PHASe:UNLock:ERRor:STATe ON	

- SOURce1 et SOURce2 n'ont pas d'importance pour cette commande.
- Si le verrouillage des phases est perdu et si l'erreur est activée, l'erreur « Reference phase-locked loop is unlocked » se produit.
- Réglage volatile perdu en cas de remise sous tension.
- Un signal de référence défectueux appliqué au connecteur **10 MHz In** peut générer plusieurs messages d'erreur.

## Sous-système PM

Le sous-système PM permet de moduler un signal sur la phase.

Vous trouverez ci-dessous un récapitulatif des opérations nécessaires à la génération d'un signal modulé en phase.

1. **Configurez le signal porteur** : Utilisez les commandes **FUNCTION**, **FREQUENCY**, **VOLTage** et **VOLTage:OFFSet** pour spécifier la fonction du signal, sa fréquence, son amplitude et sa tension résiduelle.
2. **Sélectionnez la source de modulation (interne, externe, CH1 ou CH2)** : **PM:SOURce**. Pour une source de modulation externe, ignorez les opérations 3 et 4.
3. **Définissez le signal modulant** : **PM:INTernal:FUNctIon**
4. **Définissez la fréquence de modulation** : **PM:INTernal:FREQuency**
5. **Définissez la variation de phase** : **PM:DEVIation**
6. **Activez la modulation de phase (PM)** : **PM:STATe:ON**

Le code suivant produit l'image d'oscilloscope illustrée ci-dessous.

```
FUNCTION SQU
FREQUENCY +1,0E+04
VOLTage +1,0
VOLTage:OFFSet 0,0
PM:SOURce INT
PM:DEVIation +90
PM:INTernal:FREQuency +2500
PM:INTernal:FUNctIon RAMP
PM:STATe 1
OUTPut1 1
```

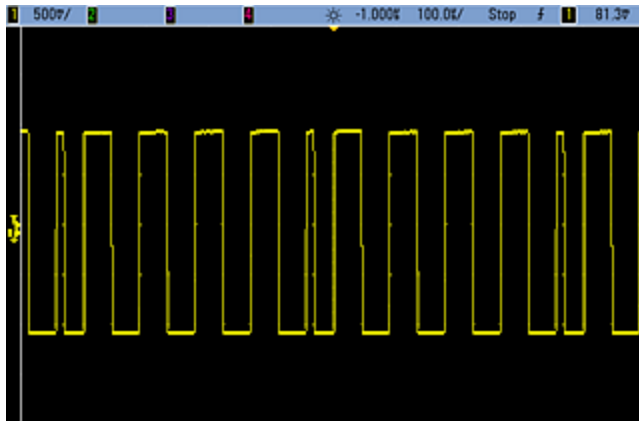



[SOURce[1|2]:]PM:DEVIation {<variation en degrés>|MINimum|MAXimum|DEFAULT}  
[SOURce[1|2]:]PM:DEVIation? [{MINimum|MAXimum}]

Définit la variation de phase en degrés. Cette valeur représente la variation maximale de la phase du signal modulé par rapport au signal porteur.

Paramètre	Renvoi type
0 à 360, 180 par défaut	+9,000000000000000E+01
Définir la variation de phase à ± 90 degrés PM:DEV 90	

- Avec la source modulante externe, la variation est contrôlée par le niveau de signal ±5 V (éventuellement ±1 V sur la série 33600) présent sur le connecteur **Modulation In** de la face arrière. Par exemple, si vous avez réglé la variation de fréquence sur 180 degrés, un niveau de signal +5 V (éventuellement ±1 V sur la série 33600) correspond à une variation de +180 degrés. Des signaux externes plus faibles produisent une variation moindre et les signaux négatifs produisent une variation négative.

[SOURce[1|2]:]PM:INTernal:FREQUency {<fréquence>|MINimum|MAXimum|DEFault}  
[SOURce[1|2]:]PM:INTernal:FREQUency? [{MINimum|MAXimum}]

Définit la fréquence du signal modulant. Le signal choisi comme source modulante fonctionne à cette fréquence dans les limites de fréquence de ce signal.

Paramètre	Renvoi type
1 µHz à la valeur maximale autorisée pour la fonction interne. Par défaut, 10 Hz.	+1,0000000000000000E-06
Définir la fréquence modulante sur 10 kHz : PM:INT:FREQ 10000  Définir la fréquence modulante sur 1 µHz : PM:INT:FREQ MIN	

- Lorsque vous sélectionnez un signal arbitraire comme source modulante, la fréquence devient la fréquence du signal arbitraire, qui est basée sur la fréquence d'échantillonnage et le nombre de points présents dans le signal arbitraire.
- Lorsque vous utilisez un signal arbitraire comme source modulante, la modification de ce paramètre se répercute sur les métadonnées en mémoire cache représentant la fréquence d'échantillonnage du signal arbitraire. Vous pouvez également modifier la fréquence modulante d'un signal arbitraire à l'aide des commandes **FUNCTion:ARBitrary:FREQUency**, **FUNCTion:ARBitrary:PERiod** et **FUNCTion:ARBitrary:SRATE**. Ces commandes et la commande de la fréquence de modulation sont directement couplées afin de maintenir exactement le même comportement du signal arbitraire que lors de sa dernière lecture. Si vous désactivez ultérieurement la modulation et sélectionnez le même signal arbitraire, sa fréquence d'échantillonnage (et la fréquence correspondante en fonction du nombre de points) sera la même que lors de sa lecture comme source de modulation.
- Si la fonction interne est TRiangle, UpRamp ou DnRamp, la fréquence maximale est limitée à 200 kHz sur la série 33500 ou à 800 kHz sur la série 33600. Si la fonction interne est PRBS, la fréquence fait référence au débit binaire et est limitée, **comme indiqué ici**.
- Cette commande doit être utilisée uniquement avec la source de modulation interne (**PM:SOURce INTernal**).

[SOURce[1|2]:]PM:INTernal:FUNcTion <fonction>

[SOURce[1|2]:]PM:INTernal:FUNcTion?

Sélectionne la forme du signal modulant.

Paramètre	Renvoi type
{SINusoid SQUare RAMP NRAMp TRIangle NOISe PRBS ARB}, SINusoid par défaut <b>Afficher les signaux de fonctions internes.</b>	SIN, SQU, RAMP, NRAM, TRI, NOIS, PRBS ou ARB
Sélectionner un signal sinusoïdal comme signal modulant : PM:INT:FUNC SIN	

- Cette commande doit être utilisée uniquement avec la source de modulation interne (**PM:SOURce INTernal**).
- Vous pouvez utiliser le bruit comme signal modulant. Toutefois, vous ne pouvez pas utiliser le bruit, des impulsions ou le courant continu comme signal porteur.

[SOURce[1|2]:]AM:SOURce {INTernal|EXTernal|CH1|CH2}

[SOURce[1|2]:]AM:SOURce?

[SOURce[1|2]:]BPSK:SOURce {INTernal|EXTernal}

[SOURce[1|2]:]BPSK:SOURce?

[SOURce[1|2]:]FM:SOURce {INTernal|EXTernal|CH1|CH2}

[SOURce[1|2]:]FM:SOURce?

[SOURce[1|2]:]FSKey:SOURce {INTernal|EXTernal}

[SOURce[1|2]:]FSKey:SOURce?

[SOURce[1|2]:]PM:SOURce {INTernal|EXTernal|CH1|CH2}

[SOURce[1|2]:]PM:SOURce?

[SOURce[1|2]:]PWM:SOURce {INTernal|EXTernal|CH1|CH2}

[SOURce[1|2]:]PWM:SOURce?

Sélectionne la source du signal modulant.

Paramètre	Renvoi type
{INTernal EXTernal CH1 CH2}, INTernal par défaut. BPSK et FSKey n'acceptent pas CH1 ou CH2	INT, EXT, CH1 ou CH2
Sélectionner la source de modulation externe : AM:SOUR EXT (peut également remplacer FM, BPSK, FSK, PM ou PWM pour AM)	

- Si vous sélectionnez EXTERNAL, le signal porteur est modulé par un signal externe. En particulier :
  - **AM** : La profondeur de modulation est contrôlée par le niveau de signal  $\pm 5$  V (ou le niveau de signal  $\pm 1$  V en option sur la série 33600) sur le connecteur **Modulation In** de la face arrière. Par exemple, si la profondeur de modulation (**AM[:DEPTH]**) est de 100 %, lorsque le signal modulant est à +5 V (ou éventuellement de +1 V sur la série 33600), l'amplitude de la sortie est maximale. De même, un signal modulant de -5 V (ou éventuellement de -1 V sur la série 33600) génère une amplitude de sortie minimale.
  - **FM** : Si vous sélectionnez la source modulante *externe*, la variation est contrôlée par le signal  $\pm 5$  V (éventuellement  $\pm 1$  V sur la série 33600) présent sur le connecteur **Modulation In** de la face arrière. Par exemple, si la variation de fréquence est de 100 kHz, un signal +5 V (éventuellement de +1 V sur la série 33600) correspond à une augmentation de fréquence de 100 kHz. Des signaux externes plus faibles produisent une variation moindre et les signaux négatifs réduisent la fréquence au-dessous de la fréquence porteuse.
  - **PM** : Avec la source modulante externe, la variation est contrôlée par le niveau de signal  $\pm 5$  V (éventuellement  $\pm 1$  V sur la série 33600) présent sur le connecteur **Modulation In** de la face arrière. Par exemple, si vous avez réglé la variation de fréquence sur 180 degrés, un niveau de signal +5 V (éventuellement  $\pm 1$  V sur la série 33600) correspond à une variation de +180 degrés. Des signaux externes plus faibles produisent une variation moindre et les signaux négatifs produisent une variation négative.
  - **Impulsion comme fonction sélectionnée** : La largeur d'impulsion ou la variation du rapport cyclique des impulsions est contrôlée par le niveau de signal  $\pm 5$  V (éventuellement  $\pm 1$  V sur la série 33600) présent sur le connecteur **Modulation In** de la face arrière. Par exemple, si vous avez défini la variation de la largeur d'impulsion à 50  $\mu$ s à l'aide de la commande **PWM:DEVIation**, un niveau de signal +5 V (éventuellement +1 V sur la série 33600) correspond à une augmentation de 50  $\mu$ s de la largeur. Des tensions externes inférieures produisent une variation inférieure.
- Avec la source EXTERNAL, la phase (BPSK) ou la fréquence (FSK) de sortie est déterminée par le niveau du signal sur le connecteur **Ext Trig** de la face arrière. Lorsque le niveau logique est bas, la phase ou la fréquence porteuse est envoyée. Lorsque le niveau logique est haut, le déphasage ou la fréquence de saut est envoyée.
- La fréquence externe maximale BPSK est de 1 MHz et la fréquence maximale FSK, de 1 MHz.
- **Remarque** : le connecteur utilisé pour les signaux BPSK ou FSK déclenchés extérieurement (**Trig In**) n'est pas le même que celui utilisé pour les signaux modulés extérieurement AM, FM, PM et PWM (**Modulation In**). Lorsqu'il est utilisé pour BPSK ou FSK, la polarité des fronts sur le connecteur **Trig In** n'est pas réglable ; ce connecteur n'est pas affecté par la commande **TRIGger[1|2]:SLOPe**.
- Avec la source INTERNAL, la vitesse de commutation de la phase (BPSK) ou de la fréquence (FSKey) de sortie entre la phase ou la fréquence porteuse et la phase ou la fréquence alternative est déterminée par la vitesse BPSK (**BPSK:INTERNAL:RATE**) ou FSK (**FSKey:INTERNAL:RATE**).
- Une voie ne peut pas être sa propre source de modulation.

## Voir également

**INPut:ATTenuation[:STATe]**

**Sous-système AM**

Sous-système BPSK

Sous-système FM

Sous-système FSKey

Sous-système PM

Sous-système PWM

[SOURce[1|2]:]AM:STATe {ON|1|OFF|0}  
[SOURce[1|2]:]AM:STATe?

[SOURce[1|2]:]BPSK:STATe {ON|1|OFF|0}  
[SOURce[1|2]:]BPSK:STATe?

[SOURce[1|2]:]FM:STATe {ON|1|OFF|0}  
[SOURce[1|2]:]FM:STATe?

[SOURce[1|2]:]FSKey:STATe {ON|1|OFF|0}  
[SOURce[1|2]:]FSKey:STATe?

[SOURce[1|2]:]PM:STATe {ON|1|OFF|0}  
[SOURce[1|2]:]PM:STATe?

[SOURce[1|2]:]PWM:STATe {ON|1|OFF|0}  
[SOURce[1|2]:]PWM:STATe?

Active ou désactive la modulation.

Paramètre	Renvoi type
{ON 1 OFF 0}, OFF par défaut	0 (OFF) ou 1 (ON)
Activer la modulation AM (peut également être FM, BPSK, FSK, PM ou PWM) : AM:STAT ON	

- Pour éviter plusieurs modifications des signaux, activez la modulation après avoir configuré les autres paramètres de modulation.
- Vous ne pouvez activer qu'un seul mode de modulation à la fois.
- L'instrument n'active pas la modulation lorsque le mode balayage ou rafale est activé. Lorsque vous activez la modulation, le mode balayage ou rafale est désactivé.
- La modulation PWM est autorisée uniquement lorsque la fonction d'impulsion est sélectionnée.

#### Voir également

[Sous-système AM](#)

[Sous-système BPSK](#)

[Sous-système FM](#)

[Sous-système FSKey](#)

[Sous-système PM](#)

[Sous-système PWM](#)

## Sous-système PWM

Le sous-système PWM permet d'exécuter la modulation de largeur des impulsions (PWM) sur un train d'impulsions.

### Exemple

Vous trouverez ci-dessous un récapitulatif des opérations nécessaires à la génération d'un signal PWM.

1. **Configurer le signal porteur d'impulsions** : Utilisez les commandes **FUNCTION**, **FREQUENCY**, **VOLTage** et **VOLTage:OFFSet** pour spécifier la fonction du signal, sa fréquence, son amplitude et sa tension résiduelle.
2. **Sélectionnez la source de modulation (interne, externe, CH1 ou CH2)** : **PWM:SOURce**. Pour une source de modulation externe, ignorez les opérations 3 et 4.
3. **Sélectionnez le signal modulant** : **PWM:INTernal:FUNCTION**
4. **Définissez la fréquence de modulation** : **PWM:INTernal:FREQUENCY**
5. **Définissez la variation de la largeur ou du rapport cyclique des impulsions** : **PWM:DEVIation** ou **PWM:DEVIation:DCYCLE**
6. **Activez la modulation PWM** : **PWM:STATE:ON**

Le code suivant produit l'image d'oscilloscope illustrée ci-dessous.

```
FUNCTION PULS
FREQUENCY +5000,0
VOLTage +1,0
VOLTage:OFFS +0,0
PWM:DEVIation +5,0E-05
PWM:DEVIation:DCYCLE +25,0
PWM:INTernal:FREQUENCY +1000,0
PWM:INTernal:FUNCTION RAMP
PWM:STATE 1
OUTPUT1 1
```

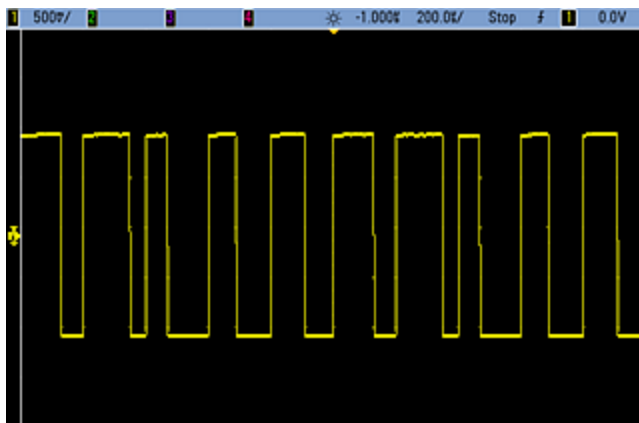

[SOURce[1|2]:]PWM:DEVIation {<variation>|MINimum|MAXimum|DEFault}  
[SOURce[1|2]:]PWM:DEVIation? [{MINimum|MAXimum}]

Configure la variation de la largeur d'impulsion ; variation  $\pm$  en largeur (en secondes) de la largeur d'impulsion du train d'impulsions porteur.

Paramètre	Renvoi type
0 à 500 000 (secondes) ; 10 $\mu$ s par défaut	+1,0000000000000000E+00
Régler la variation de la largeur d'impulsion sur 1 s : PWM:DEV 1  Régler la variation de la largeur d'impulsion sur 0 s : PWM:DEV MIN	

- La variation est une variation  $\pm$  ; si la largeur d'impulsion est égale à 10 ms et la variation à 4 ms, la largeur peut varier entre 6 et 14 ms.
- La variation de la largeur d'impulsion ne peut pas être supérieure à la largeur d'impulsion actuelle, et est également limitée par la largeur d'impulsion minimale ( $W_{min}$ ) :

Variation de largeur < Largeur d'impulsion –  $W_{min}$

et

Variation de largeur < Période – Largeur d'impulsion –  $W_{min}$

- Le temps de front actif limite la variation de la largeur d'impulsion.

Variation de largeur < Largeur d'impulsion – (0,8 x Temps du front montant) – (0,8 x Temps du front descendant)

et

Variation de largeur < Période – Largeur d'impulsion – (0,8 x Temps du front montant) – (0,8 x Temps du front descendant)

- Si vous sélectionnez la source modulante externe (**PWM:SOURce EXTERNAL**), la variation est contrôlée par le niveau de signal  $\pm 5$  V (éventuellement  $\pm 1$  V sur la série 33600) présent sur le connecteur **Modulation In** de la face arrière. Par exemple, si vous avez réglé la variation de largeur sur 10  $\mu$ s, un niveau de signal +5 V (éventuellement +1 V sur la série 33600) correspond à une variation de 10  $\mu$ s. Des tensions externes inférieures produisent une variation inférieure. Les signaux négatifs produisent des variations négatives.



[SOURce[1|2]:]PWM:DEVIation:DCYCLE {<variation\_en\_pct>|MINimum|MAXimum|DEFAULT}  
[SOURce[1|2]:]PWM:DEVIation:DCYCLE? [{MINimum|MAXimum}]

Définit la variation du rapport cyclique en pourcentage de la période. Il s'agit de la variation maximale du rapport cyclique du train d'impulsions sous-jacent. Par exemple, si le rapport cyclique est de 10 % et si sa variation est de 5 %, le rapport cyclique du signal modulé varie entre 5 et 15 %.

Paramètre	Renvoi type
Rapport cyclique en pourcentage de la période, de 0 à 50 ; 1 par défaut	+5,000000000000000E+00
Régler la variation de la largeur d'impulsion sur 5 % : PWM:DEV:DCYC 5	

- La variation du rapport cyclique ne peut pas être supérieure au rapport cyclique des impulsions.
- La largeur d'impulsion minimale (Wmin) limite également la variation du rapport cyclique :

$$\text{Variation du rapport cyclique} < \text{Rapport cyclique} - 100 \times W_{\text{min}} \div \text{Période}$$

et

$$\text{Variation du rapport cyclique} < 100 - \text{Rapport cyclique} - 100 \times W_{\text{min}} \div \text{Période}$$

où Wmin = 16 ns sur la série 33500 et 5 ns jusqu'à 4 Vpp ou 8 ns jusqu'à 10 Vpp sur la série 33600.

- Variation du rapport cyclique limitée par le temps de front.

$$\text{Var rapport cyclique} < \text{Rapport cyclique} - (80 \times \text{Temps du front montant}) \div \text{Période} - (80 \times \text{Temps du front descendant}) \div \text{Période}$$

et

$$\text{Var rapport cyclique} < 100 - \text{Rapport cyclique} - (80 \times \text{Temps du front montant}) \div \text{Période} - (80 \times \text{Temps du front descendant}) \div \text{Période}$$

- Avec la commande (**PWM:SOURce EXTernal**), la variation est contrôlée par le niveau signal ±5 V (éventuellement ±1 V sur la série 33600) présent sur le connecteur **Modulation In** de la face arrière. Par exemple, avec une variation du rapport cyclique de 5 %, un signal +5 V correspond à une variation de 5 % (éventuellement +1 V sur la série 33600), soit une variation de la période de 5 % supplémentaires ajoutés au rapport cyclique des impulsions. Des signaux externes plus faibles produisent une variation moindre et les signaux négatifs réduisent le rapport cyclique.

[SOURce[1|2]:]PWM:INTernal:FREQuency {<fréquence>|MINimum|MAXimum|DEFAULT}  
[SOURce[1|2]:]PWM:INTernal:FREQuency? [{MINimum|MAXimum}]

Sélectionne la fréquence à laquelle la largeur d'impulsion en sortie dérive avec la variation de la largeur d'impulsion. Le signal utilisé comme source modulante fonctionne à cette fréquence dans les limites de fréquence de ce signal.

Paramètre	Renvoi type
1 µHz à la <b>valeur maximale autorisée pour la fonction interne</b> . Par défaut, 10 Hz	+1,0000000000000000E+02
Définir la fréquence PWM interne à 100 Hz : PWM:INT:FREQ 100	

- Lorsque vous sélectionnez un signal arbitraire comme source modulante, la fréquence devient la fréquence du signal arbitraire, qui est basée sur la fréquence d'échantillonnage et le nombre de points présents dans le signal arbitraire.
- Lorsque vous utilisez un signal arbitraire comme source modulante, la modification de ce paramètre se répercute sur les métadonnées en mémoire cache représentant la fréquence d'échantillonnage du signal arbitraire. Vous pouvez également modifier la fréquence modulante d'un signal arbitraire à l'aide des commandes **FUNCTION:ARbitrary:FREQuency**, **FUNCTION:ARbitrary:PERiod** et **FUNCTION:ARbitrary:SRATE**. Ces commandes et la commande de la fréquence de modulation sont directement couplées afin de maintenir exactement le même comportement du signal arbitraire que lors de sa dernière lecture. Si vous désactivez ultérieurement la modulation et sélectionnez le même signal arbitraire, sa fréquence d'échantillonnage (et la fréquence correspondante en fonction du nombre de points) sera la même que lors de sa lecture comme source de modulation.
- Si la fonction interne est TRiangle, UpRamp ou DnRamp, la fréquence maximale est limitée à 200 kHz sur la série 33500 ou à 800 kHz sur la série 33600. Si la fonction interne est PRBS, la fréquence fait référence au débit binaire et est limitée, **comme indiqué ici**.
- Cette commande doit être utilisée uniquement avec la source de modulation interne (**PWM:SOURce INTernal**).

[SOURce[1|2]:]PWM:INTernal:FUNctIon <fonction>

[SOURce[1|2]:]PWM:INTernal:FUNctIon?

Sélectionne la forme du signal modulant interne.

Paramètre	Renvoi type
{SINusoid SQUare RAMP NRAMp TRIangle NOISe PRBS ARB}, SINusoid par défaut <b>Afficher les signaux de fonctions internes.</b>	SIN, SQU, RAMP, NRAM, TRI, NOIS, PRBS ou ARB
Sélectionner un signal sinusoïdal comme forme du signal modulant : PWM:INT:FUNC SIN	

- Cette commande doit être utilisée uniquement avec la source de modulation interne (**PWM:SOURce INTernal**).

[SOURce[1|2]:]AM:SOURce {INTernal|EXTernal|CH1|CH2}

[SOURce[1|2]:]AM:SOURce?

[SOURce[1|2]:]BPSK:SOURce {INTernal|EXTernal}

[SOURce[1|2]:]BPSK:SOURce?

[SOURce[1|2]:]FM:SOURce {INTernal|EXTernal|CH1|CH2}

[SOURce[1|2]:]FM:SOURce?

[SOURce[1|2]:]FSKey:SOURce {INTernal|EXTernal}

[SOURce[1|2]:]FSKey:SOURce?

[SOURce[1|2]:]PM:SOURce {INTernal|EXTernal|CH1|CH2}

[SOURce[1|2]:]PM:SOURce?

[SOURce[1|2]:]PWM:SOURce {INTernal|EXTernal|CH1|CH2}

[SOURce[1|2]:]PWM:SOURce?

Sélectionne la source du signal modulant.

Paramètre	Renvoi type
{INTernal EXTernal CH1 CH2}, INTernal par défaut. BPSK et FSKey n'acceptent pas CH1 ou CH2	INT, EXT, CH1 ou CH2
Sélectionner la source de modulation externe : AM:SOUR EXT (peut également remplacer FM, BPSK, FSK, PM ou PWM pour AM)	

- Si vous sélectionnez EXTERNAL, le signal porteur est modulé par un signal externe. En particulier :
  - **AM** : La profondeur de modulation est contrôlée par le niveau de signal  $\pm 5$  V (ou le niveau de signal  $\pm 1$  V en option sur la série 33600) sur le connecteur **Modulation In** de la face arrière. Par exemple, si la profondeur de modulation (**AM[:DEPTH]**) est de 100 %, lorsque le signal modulant est à +5 V (ou éventuellement de +1 V sur la série 33600), l'amplitude de la sortie est maximale. De même, un signal modulant de -5 V (ou éventuellement de -1 V sur la série 33600) génère une amplitude de sortie minimale.
  - **FM** : Si vous sélectionnez la source modulante *externe*, la variation est contrôlée par le signal  $\pm 5$  V (éventuellement  $\pm 1$  V sur la série 33600) présent sur le connecteur **Modulation In** de la face arrière. Par exemple, si la variation de fréquence est de 100 kHz, un signal +5 V (éventuellement de +1 V sur la série 33600) correspond à une augmentation de fréquence de 100 kHz. Des signaux externes plus faibles produisent une variation moindre et les signaux négatifs réduisent la fréquence au-dessous de la fréquence porteuse.
  - **PM** : Avec la source modulante externe, la variation est contrôlée par le niveau de signal  $\pm 5$  V (éventuellement  $\pm 1$  V sur la série 33600) présent sur le connecteur **Modulation In** de la face arrière. Par exemple, si vous avez réglé la variation de fréquence sur 180 degrés, un niveau de signal +5 V (éventuellement  $\pm 1$  V sur la série 33600) correspond à une variation de +180 degrés. Des signaux externes plus faibles produisent une variation moindre et les signaux négatifs produisent une variation négative.
  - **Impulsion comme fonction sélectionnée** : La largeur d'impulsion ou la variation du rapport cyclique des impulsions est contrôlée par le niveau de signal  $\pm 5$  V (éventuellement  $\pm 1$  V sur la série 33600) présent sur le connecteur **Modulation In** de la face arrière. Par exemple, si vous avez défini la variation de la largeur d'impulsion à 50  $\mu$ s à l'aide de la commande **PWM:DEVIation**, un niveau de signal +5 V (éventuellement +1 V sur la série 33600) correspond à une augmentation de 50  $\mu$ s de la largeur. Des tensions externes inférieures produisent une variation inférieure.
- Avec la source EXTERNAL, la phase (BPSK) ou la fréquence (FSK) de sortie est déterminée par le niveau du signal sur le connecteur **Ext Trig** de la face arrière. Lorsque le niveau logique est bas, la phase ou la fréquence porteuse est envoyée. Lorsque le niveau logique est haut, le déphasage ou la fréquence de saut est envoyée.
- La fréquence externe maximale BPSK est de 1 MHz et la fréquence maximale FSK, de 1 MHz.
- **Remarque** : le connecteur utilisé pour les signaux BPSK ou FSK déclenchés extérieurement (**Trig In**) n'est pas le même que celui utilisé pour les signaux modulés extérieurement AM, FM, PM et PWM (**Modulation In**). Lorsqu'il est utilisé pour BPSK ou FSK, la polarité des fronts sur le connecteur **Trig In** n'est pas réglable ; ce connecteur n'est pas affecté par la commande **TRIGger[1|2]:SLOPe**.
- Avec la source INTERNAL, la vitesse de commutation de la phase (BPSK) ou de la fréquence (FSKey) de sortie entre la phase ou la fréquence porteuse et la phase ou la fréquence alternative est déterminée par la vitesse BPSK (**BPSK:INTERNAL:RATE**) ou FSK (**FSKey:INTERNAL:RATE**).
- Une voie ne peut pas être sa propre source de modulation.

## Voir également

**INPut:ATTenuation[:STATE]**

**Sous-système AM**

Sous-système BPSK

Sous-système FM

Sous-système FSKey

Sous-système PM

Sous-système PWM

[SOURce[1|2]:]AM:STATe {ON|1|OFF|0}  
[SOURce[1|2]:]AM:STATe?

[SOURce[1|2]:]BPSK:STATe {ON|1|OFF|0}  
[SOURce[1|2]:]BPSK:STATe?

[SOURce[1|2]:]FM:STATe {ON|1|OFF|0}  
[SOURce[1|2]:]FM:STATe?

[SOURce[1|2]:]FSKey:STATe {ON|1|OFF|0}  
[SOURce[1|2]:]FSKey:STATe?

[SOURce[1|2]:]PM:STATe {ON|1|OFF|0}  
[SOURce[1|2]:]PM:STATe?

[SOURce[1|2]:]PWM:STATe {ON|1|OFF|0}  
[SOURce[1|2]:]PWM:STATe?

Active ou désactive la modulation.

Paramètre	Renvoi type
{ON 1 OFF 0}, OFF par défaut	0 (OFF) ou 1 (ON)
Activer la modulation AM (peut également être FM, BPSK, FSK, PM ou PWM) : AM:STAT ON	

- Pour éviter plusieurs modifications des signaux, activez la modulation après avoir configuré les autres paramètres de modulation.
- Vous ne pouvez activer qu'un seul mode de modulation à la fois.
- L'instrument n'active pas la modulation lorsque le mode balayage ou rafale est activé. Lorsque vous activez la modulation, le mode balayage ou rafale est désactivé.
- La modulation PWM est autorisée uniquement lorsque la fonction d'impulsion est sélectionnée.

#### Voir également

[Sous-système AM](#)

[Sous-système BPSK](#)

[Sous-système FM](#)

[Sous-système FSKey](#)

[Sous-système PM](#)

[Sous-système PWM](#)

## Sous-système RATE

Le sous-système RATE permet de coupler les fréquences d'échantillonnage des sorties d'un instrument 2 voies en spécifiant les éléments suivants :

- `[SOURCE[1|2]:]RATE:COUPLE[:STATe] {ON|1|OFF|0}`
- `[SOURCE[1|2]:]RATE:COUPLE:MODE {OFFSet|RATIo}`
- `[SOURCE[1|2]:]RATE:COUPLE:OFFSet {<fréquence_échantillonnage>|MINimum|MAXimum|DEFault}`
- `[SOURCE[1|2]:]RATE:COUPLE:RATIo {<rapport>|MINimum|MAXimum}`

`[SOURCE[1|2]:]RATE:COUPLE[:STATe] {ON|1|OFF|0}`

`[SOURCE[1|2]:]RATE:COUPLE[:STATe]?`

Active/désactive le couplage des fréquences d'échantillonnage entre des voies ou autorise la copie unique de la fréquence d'échantillonnage d'une voie dans une autre voie.

Paramètre	Renvoi type
{ON 1 OFF 0}, OFF par défaut	0 (OFF) ou 1 (ON)
Activer le couplage des fréquences d'échantillonnage : RATE:COUP ON	

- L'activation de cette valeur (ON) démarre le couplage des fréquences d'échantillonnage dans le mode spécifié par `RATE:COUPLE:MODE`.
- Si le décalage ou le rapport actif, associé aux réglages de fréquence d'échantillonnage actifs, entraîne une fréquence d'échantillonnage supérieure aux spécifications de l'instrument, celui-ci génère une erreur ; la fréquence d'échantillonnage excédentaire est rognée à sa valeur maximale ou minimale.
- Si, le mode étant actif `RATIO` et le paramètre `RATIO` valant 1.0, les spécifications des voies ne sont toujours pas respectées, un message d'erreur est généré et la commande `RATE:COUPLE[:STATe]` n'est pas activée.
- Les deux voies doivent être configurées pour `FUNCTion ARB` afin d'activer le couplage des fréquences d'échantillonnage.

**[SOURce[1|2]:]RATE:COUPLE:MODE {OFFSet|RATio}**  
**[SOURce[1|2]:]RATE:COUPLE:MODE?**

Définit le type de couplage des fréquences d'échantillonnage sur un décalage constant (OFFSet) ou un rapport constant (RATio) entre les fréquences d'échantillonnage des voies.

Paramètre	Renvoi type
{OFFSet RATio}, RATio par défaut	OFFS ou RAT
Définir le mode de couplage des fréquences d'échantillonnage sur OFFSet. RATE:COUP:MODE OFFSet	

- Le rapport par défaut est 1.
- Le couplage des fréquences d'échantillonnage est désactivé (OFF) par défaut.
- Le mot clé SOURce[1|2] est ignoré ; le réglage s'applique aux deux voies.

**[SOURce[1|2]:]RATE:COUPLE:OFFSet {<fréquence\_échantillonnage>|MINimum|MAXimum|DEFAULT}**  
**[SOURce[1|2]:]RATE:COUPLE:OFFSet?**

Configure le décalage de la fréquence d'échantillonnage lorsqu'un instrument 2 voies est en mode de couplage OFFSet.

Paramètre	Renvoi type
Les valeurs valides varient en fonction du paramètre <b>FUNCTION:ARbitrary:FILTer</b> . Pour NORMal et STEP, la plage est comprise entre $\pm 250$ M.éch/s (série 33500) ou $\pm 1$ G.éch/s (série 33600). Pour OFF, la plage est comprise entre $\pm 62,5$ M.éch/s (série 33500) ou $\pm 250$ M.éch/s (série 33600). Dans tous les cas, la valeur par défaut est 0.	+8,000000000000000E+02
Définir le décalage de la fréquence d'échantillonnage de la voie 2 sur 10,3 k.éch/s au-dessus de la fréquence d'échantillonnage de la voie 1. RATE:COUPLE:OFFSet 10300	
Définir le décalage de la fréquence d'échantillonnage de la voie 1 sur 45 k.éch/s au-dessous de la fréquence d'échantillonnage de la voie 2. SOUR2:RATE:COUP:OFFS -45000	

- Lorsque vous spécifiez OFFSet ou RATio, la voie SOURce (SOURce1 ou SOURce2) est utilisée comme voie de référence, et le décalage ou le rapport s'applique à l'autre voie. Par exemple, supposons que **RATE:COUPLE:STATe** soit activé (ON) et que **RATE:COUPLE:MODE** soit défini sur OFFSet. De plus, supposons que la voie 1 fonctionne à 2 kéch/s et la voie 2 à 10 kéch/s. La commande **SOUR1:RATE:COUP:OFFS 2.5** maintient la voie 1 à 2 éch/s et configure la voie 2 sur 4,5 éch/s. Toute modification de la fréquence d'échantillonnage d'une voie est reflétée sur l'autre voie afin de conserver le couplage spécifié.
- Si le couplage de la fréquence d'échantillonnage entraîne le dépassement des spécifications de fréquence d'échantillonnage pour les fonctions en cours, la commande provoque une erreur et la fréquence d'échantillonnage est définie à sa limite supérieure ou inférieure pour cette voie.



[SOURce[1|2]:]RATE:COUPle:RATio {<rapport>|MINimum|MAXimum}  
[SOURce[1|2]:]RATE:COUPle:RATio? [{MINimum|MAXimum}]

Configure le rapport entre les fréquences d'échantillonnage lorsqu'un instrument 2 voies est en mode de couplage RATio.

Paramètre	Renvoi type
0,001 à 1 000, 1 par défaut	+7,500000000000000E-1
Configurer la fréquence d'échantillonnage de la voie 2 pour être égale à 2 fois celle de la voie 1. SOUR1:RATE:COUP:RATio 2	
Configurer la fréquence d'échantillonnage de la voie 1 pour être égale à 3,14 fois celle de la voie 2. SOUR2:RATE:COUPle:RAT 3,14	

- Lorsque vous spécifiez OFFSet ou RATio, la voie SOURce (SOURce1 ou SOURce2) est utilisée comme voie de référence, et le décalage ou le rapport s'applique à l'autre voie. Par exemple, supposons que l'instrument soit couplé en mode RATio. De plus, supposons que la voie 1 fonctionne à 2 kéch/s et la voie 2 à 10 kéch/s. La commande **SOUR1:RAT:COUP:RAT 2.5** maintient la voie à 2 kéch/s et configure la voie 2 sur 5 kéch/s. Toute modification de la fréquence d'échantillonnage d'une voie est reflétée sur l'autre voie afin de conserver le couplage spécifié.
- Si le couplage de la fréquence d'échantillonnage entraîne le dépassement des spécifications de fréquence d'échantillonnage pour les fonctions en cours, la commande provoque une erreur et la fréquence d'échantillonnage est définie à sa limite supérieure ou inférieure pour cette voie.

## Sous-système ROSCillator

### AVERTISSEMENT

Le connecteur BNC d'entrée de référence 10 MHz situé sur la face arrière de l'instrument est isolé jusqu'à  $\pm 42$  V crête du châssis. Le boîtier de ce connecteur BNC est isolé du reste de l'instrument. La circuiterie interne tentera de maintenir la tension isolée dans les limites de  $\pm 42$  V crête par rapport au châssis. Toute tentative de configuration de cette entrée au-delà de  $\pm 42$  V crête du châssis peut détruire l'instrument et provoquer des risques de blessures graves, voire mortelles.

### REMARQUE

La sortie 10 MHz de l'instrument est reliée au châssis.

Le sous-système ROSCillator contrôle l'utilisation de l'oscillateur de référence 10 MHz de l'entrée de l'oscillateur de référence externe. L'oscillateur de référence est l'horloge principale pour la synthèse de tous les signaux. Tous les signaux sont verrouillés en phase par rapport à l'oscillateur de référence qui contrôle donc la fréquence et la phase du signal de sortie.

- **ROSCillator:SOURce {INTERNAL|EXTERNAL}** - sélectionne la source de l'oscillateur de référence interne ou externe
- **ROSCillator:SOURce:AUTO {ON|OFF}** - active/désactive la sélection automatique de la source du signal de l'oscillateur de référence

- **ROSCillator:SOURce:CURRent?** - renvoie INT ou EXT pour indiquer la source actuelle de l'oscillateur de référence

ROSC:SOURce définit la commande ROSCillator:SOURce:AUTO sur OFF et ROSCillator:SOURce:AUTO ON remplace ROSC:SOURce. La commande la plus récente (des deux) est prioritaire.

ROSCillator:SOURce INTernal utilise l'oscillateur interne de l'instrument comme oscillateur de référence. Il peut s'agir d'un oscillateur à quartz à compensation de température (TCXO - Temperature Compensated Crystal Oscillator) ou d'un **oscillateur à quartz thermostaté (OCXO - Ovenized Crystal Oscillator) en option**.

Pour savoir si l'oscillateur OCXO est installé, reportez-vous à la section **\*OPT?**. Si un signal de référence externe 10 MHz est présent sur le connecteur **10 MHz In** de la face arrière, l'instrument utilise ce signal. Une icône s'affiche dans l'angle supérieur droit de l'écran pour indiquer la modification de la source de référence.

### ROSCillator:SOURce {INTernal|EXTernal}

#### ROSCillator:SOURce?

Sélectionne la source de l'oscillateur de référence de fréquence/phase des signaux générés par l'instrument.

Paramètre	Renvoi type
{INTernal EXTernal}, INT par défaut	INT ou EXT
Utiliser la source de l'oscillateur de référence externe : ROSC:SOUR EXT	

- **EXTernal** : l'instrument utilise le signal sur le connecteur **10 MHz In** de la face arrière et génère une erreur si ce signal est absent ou si l'instrument ne peut pas le verrouiller. Lorsque ces erreurs se produisent, l'instrument continue à envoyer des signaux, mais la fréquence est instable.
- **INTernal** : l'instrument utilise l'oscillateur de référence interne et ignore le signal sur le connecteur **10 MHz In**.

### ROSCillator:SOURce:AUTO {ON|OFF}

#### ROSCillator:SOURce:AUTO?

Active/désactive la sélection automatique de l'oscillateur de référence.

Paramètre	Renvoi type
{ON OFF}, ON par défaut	ON ou OFF
Sélectionner automatiquement la source de référence : ROSC:SOUR:AUTO ON	

- **ON** : l'instrument sélectionne de préférence un signal de 10 MHz sur le connecteur **10 MHz In** de la face arrière.
- **OFF** : l'instrument sélectionne l'oscillateur de référence en fonction du paramètre **ROSC:SOURce**.

## ROSCillator:SOURce:CURRent?

Indique le signal de l'oscillateur de référence utilisé lorsque le paramètre **ROSC:SOURce:AUTO** est activé (ON).

Paramètre	Renvoi type
(aucun)	INT (interne) ou EXT (connecteur 10 MHz sur la face arrière)
Déterminer la source du signal de référence : ROSC:SOUR:CURR?	

- INT désigne l'oscillateur interne de base TCXO ou l'**oscillateur à quartz thermostaté OCXO** qui est installé.

## Sous-système SOURce

Le mot clé SOURce est facultatif dans de nombreuses commandes qui définissent les paramètres d'une voie d'entrée ou de sortie.

### Exemple

Le mot clé SOURce et le numéro de la voie sont facultatifs dans la requête [SOURce[1|2]:]AM[:DEPTH?]. S'ils sont omis, la source par défaut est la voie 1. Le tableau suivant illustre diverses interprétations de cette requête.

Paramètre	Renvoi type
AM:DEPTH?	renvoie la profondeur de modulation de la voie 1
SOUR1:AM:DEPTH?	renvoie la profondeur de modulation de la voie 1
SOUR2:AM:DEPTH?	renvoie la profondeur de modulation de la voie 2 (instruments 2 voies uniquement)

### Sous-systèmes utilisant le mot clé SOURce facultatif

Du fait que les commandes du sous-système SOURce sont souvent utilisées sans le mot clé SOURce, elles sont répertoriées par sous-systèmes, indiqués ci-dessous :

AM

APPLy

BPSK

BURSt

DATA

FM

FREQuency

FSKey

FUNcTion

LIST

MARKer

PHASe

PM

PWM

ROSCillator

SUM

SWEep

VOLTage

### Commandes utilisant le mot clé SOURce facultatif

Les commandes suivantes, qui ne font partie d'aucun sous-système, comportent également le mot clé SOURce en option :

COMBine:FEED

TRACK

## Présentation du sous-système STATUS

Le système de l'état SCPI de l'instrument enregistre diverses conditions et états de l'instrument dans plusieurs groupes de registres.

Dans ce sous-système, un événement est un fait qui s'est produit, même s'il peut ne pas se reproduire. Une condition est une situation existante. Une condition apparaît dans le registre des événements, mais celui-ci est effacé (0) lorsqu'il est lu.

Les commandes **STATUS** manipulent des bits dans deux des registres d'activation. Vous pouvez :

- activer des bits dans le registre **d'activation des données suspectes** (**STATUS:QUESTIONABLE:ENABLE <valeur\_activation>**). Requête : **STATUS:QUESTIONABLE:ENABLE?**
- activer des bits dans le registre **d'activation du fonctionnement** (**STATUS:OPERATION:ENABLE <valeur\_activation>**). Requête : **STATUS:OPERATION:ENABLE?**
- effacer tous les bits dans le registre d'activation des **données suspectes** et dans le registre d'activation de fonctionnement standard (**STATUS:PRESET**).

Les requêtes **STATUS** accèdent aux informations sur les bits d'état dans les registres de **données suspectes**, notamment :

- La somme binaire pondérée de tous les bits actifs du registre des **conditions** des données suspectes (**STATUS:QUESTIONABLE:CONDITION?**)
- La somme binaire pondérée de tous les bits actifs du registre des **événements** de données suspectes (**STATUS:QUESTIONABLE[:EVENT]?**)
- La somme binaire pondérée de tous les bits actifs du registre d'**activation** de données suspectes (**STATUS:QUESTIONABLE:ENABLE <valeur\_activation>**)

Les requêtes **STATUS** permettent d'accéder aux informations sur les bits d'état dans les registres de **fonctionnement**, notamment :

- La somme binaire pondérée de tous les bits actifs du registre des **conditions** de fonctionnement (**STATUS:OPERATION:CONDITION?**)
- La somme binaire pondérée de tous les bits actifs du registre des **événements** de fonctionnement (**STATUS:OPERATION[:EVENT]?**)

## Groupe de registres de fonctionnement standard

Le tableau ci-dessous décrit le groupe de registres de fonctionnement standard

Numéro de bit	Nom de bit	Valeur décimale	Définition
<b>0</b>	Étalonnage	1	L'instrument effectue un étalonnage.
<b>1</b>	Autotest	2	Un autotest est effectué.
<b>2</b>	(Réservé)	4	(Réservé à une utilisation ultérieure).
<b>3</b>	Voie 1 démarrée	8	La voie a démarré et envoie le signal désiré. Dans INIT [1 2]:CONT OFF, ce bit est actif après la réception d'une commande INIT ; il n'est pas effacé tant que la voie ne passe pas à l'état IDLE (nombre de déclenchements réalisés et non occupé). Ce bit est égal à 0 si la voie est en mode INIT[1 2]:CONT ON.
<b>4</b>	Voie 2 démarrée	16	
<b>5</b>	Attente de déclenchement, voie 1	32	L'instrument attend un déclenchement. Dans INIT [1 2]:CONT OFF, ce bit est actif après la réception d'une commande INIT et pendant l'attente d'un déclenchement. Il est effacé après la réception du déclenchement. Ce bit est égal à 0 si la voie est en mode INIT [1 2]:CONT ON.
<b>6</b>	Attente de déclenchement, voie 2	64	
<b>7</b>	(Réservé)	128	(Réservé à une utilisation ultérieure).
<b>8</b>	Événement de modification de configuration	256	Ce bit est toujours égal à 0 dans le registre des conditions, car il reflète un événement et non une condition.
<b>9</b>	(Réservé)	512	(Réservé à une utilisation ultérieure).
<b>10</b>	Instrument verrouillé	1024	Si une interface distante (USB ou réseau local) est verrouillée (SYSTEM:LOCK:REQuest?), ce bit sera actif. Lorsqu'une interface distante débloque le verrouillage (SYSTEM:LOCK:RELease), ce bit sera effacé.
<b>11</b>	(Réservé)	2048	(Réservé à une utilisation ultérieure).
<b>12</b>	(Réservé)	4096	(Réservé à une utilisation ultérieure).
<b>13</b>	Erreur globale	8192	Il est actif si une interface distante comporte une erreur dans sa file d'erreurs, sinon, il est effacé.
<b>14-15</b>	(Réservé)	16,384 - 32,768	(Réservé à une utilisation ultérieure).

## Groupe de registres de données suspectes

Le tableau ci-dessous décrit le groupe de registres de données suspectes

Numéro de bit	Nom de bit	Valeur décimale	Définition
<b>0</b>	Surcharge de tension voie 1	1	Surcharge de tension sur le connecteur de sortie de la voie 1. La sortie a été désactivée.
<b>1</b>	Surcharge de tension voie 2	2	Surcharge de tension sur le connecteur de sortie de la voie 2. La sortie a été désactivée.
<b>2</b>	(Réservé)	4	(Réservé à une utilisation ultérieure).
<b>3</b>	(Réservé)	8	(Réservé à une utilisation ultérieure).
<b>4</b>	(Réservé)	16	(Réservé à une utilisation ultérieure).
<b>5</b>	Boucle déverrouillée	32	Le générateur de fonctions a perdu le verrouillage de phase. La précision de la fréquence est affectée.
<b>6</b>	(Réservé)	64	(Réservé à une utilisation ultérieure).
<b>7</b>	(Réservé)	128	(Réservé à une utilisation ultérieure).
<b>8</b>	Erreur d'étalonnage	256	Une erreur s'est produite pendant l'étalonnage, la sécurité de l'étalonnage est déverrouillée ou la mémoire d'étalonnage est perdue.
<b>9</b>	Référence externe	512	La base de temps externe a été détectée.
<b>10-15</b>	(Réservé)	1024 - 32,768	(Réservé à une utilisation ultérieure).



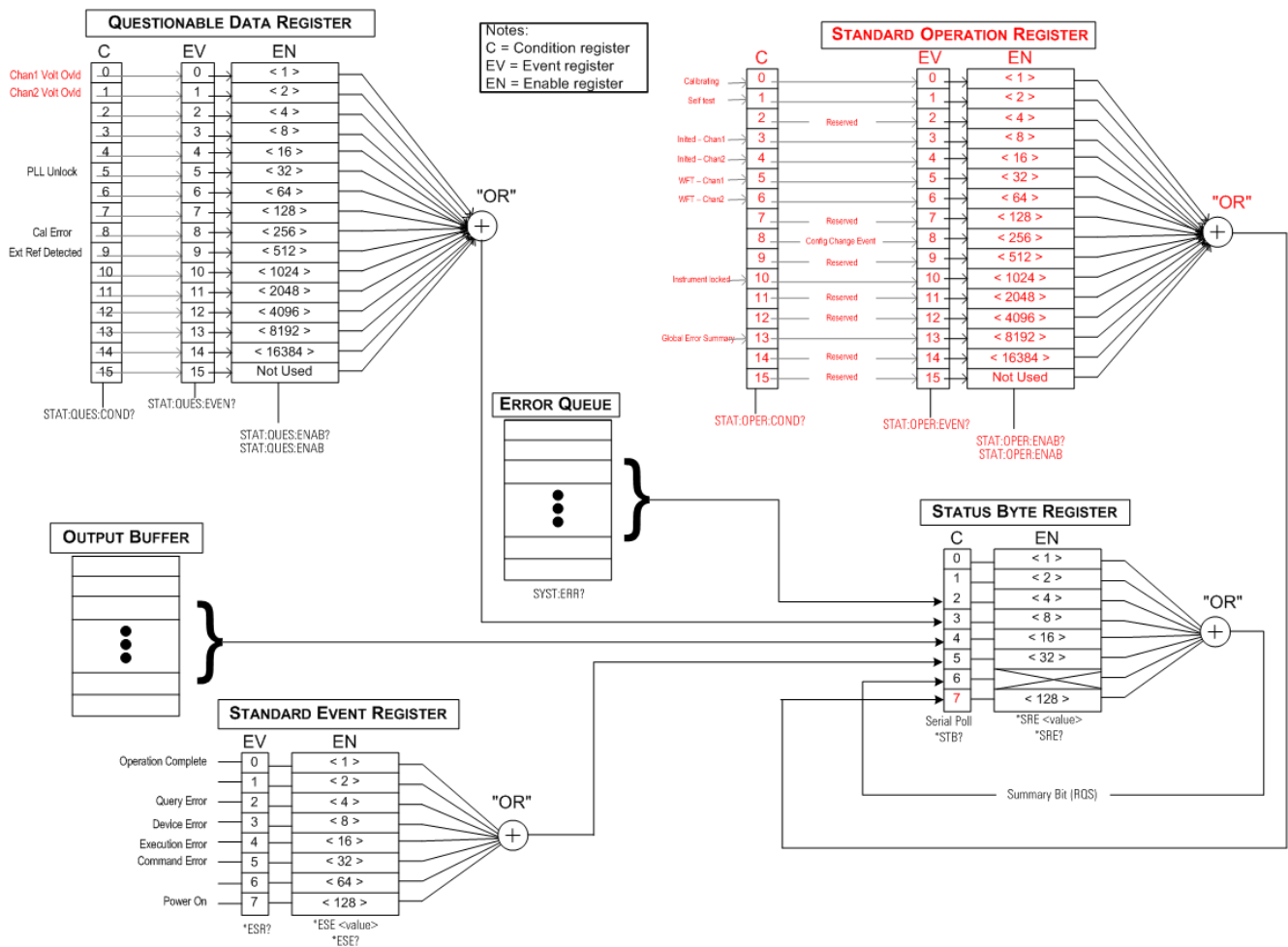

### STATus:OPERation:CONDition?

Recherche le groupe **registres de fonctionnement standard** dans le registre des conditions. Registre en lecture seule ; bits non effacés lorsqu'il est lu.

Paramètre	Renvoi type
(aucun)	+32
Lire le registre de conditions (bit 5 actif) : STAT:OPER:COND?	

- Les bits du registre des conditions reflètent l'état actuel. Si une condition est remplie, le bit correspondant est effacé.
- La commande **\*RST** efface ce registre, sauf les bits où la condition existe toujours après l'exécution de la commande \*RST.
- La commande lit la condition de registre et renvoie une valeur décimale égale à la somme binaire pondérée de tous les bits actifs du registre. Par exemple, si le bit 5 (valeur décimale = 32) et le bit 9 (valeur décimale = 512) sont actifs, la commande renvoie la valeur +544.

**STATus:OPERation:ENABle** <valeur\_activation>

**STATus:OPERation:ENABle?**

Active les bits du **registre d'activation** du groupe de **registres de fonctionnement standard**. Les bits sélectionnés sont alors reportés dans l'octet d'état en tant que bit récapitulatif du fonctionnement standard.

Paramètre	Renvoi type
Somme des valeurs décimales des bits du registre.	+256
Activer le bit 8 (valeur décimale 256) dans le registre d'activation : STAT:OPER:ENAB 256	

- Utilisez <valeur\_activation> pour spécifier les bits à reporter dans l'octet d'état. La valeur spécifiée correspond à la somme binaire pondérée des bits du registre à activer. Par exemple, pour activer le bit 5 (valeur 32) et le bit 9 (valeur 512), cette valeur décimale est 544.
- La commande **\*CLS** efface le registre des événements, mais pas le registre d'activation.
- Ce registre est effacé à la mise sous tension, sauf si **\*PSC** est défini sur 0.

Voir également

**\*STB?**

**STATus:OPERation[:EVENT]?**

Recherche le groupe de **registres de fonctionnement standard** dans le registre des événements. Ce registre est en lecture seule ; les bits sont effacés lorsque vous le lisez.

Paramètre	Renvoi type
(aucun)	+32
Lire le registre des événements : STAT:OPER:EVEN?	

- Un bit actif demeure actif jusqu'à ce qu'il soit effacé par la lecture du registre des événements ou la commande **\*CLS**.
- La commande **\*RST** n'affecte pas ce registre.
- La requête lit l'événement de registre et renvoie une valeur décimale égale à la somme binaire pondérée de tous les bits actifs du registre. Par exemple, si le bit 5 (valeur = 32) et le bit 9 (valeur = 512) sont actifs, la commande renvoie la valeur +544.

## STATus:PRESet

Efface les registres d'activation de **données suspectes** et de **fonctionnement standard**.

Paramètre	Renvoi type
(aucun)	(aucun)
Effacer les bits du registre d'activation : STAT:PRES	

## STATus:QUEStionable:CONDition?

Recherche le **groupe de registre des données suspectes** dans le registre des conditions.

Paramètre	Renvoi type
(aucun)	+512
Lire le registre de conditions (bit 9 actif) : STAT:QUES:COND?	

- Le groupe de registres des données suspectes contient des informations sur la qualité ou l'intégrité de l'instrument.
- Une ou toutes les conditions peuvent être reportées dans le bit récapitulatif des données suspectes au moyen du registre d'activation.
- Registre en lecture seule ; bits non effacés lorsqu'il est lu.
- Les bits du registre des conditions reflètent l'état actuel. Si une condition est remplie, le bit correspondant est effacé.
- La commande **\*RST** efface le registre des conditions.
- La requête lit la condition de registre et renvoie une valeur décimale égale à la somme binaire pondérée de tous les bits actifs du registre. Par exemple, si le bit 12 (valeur décimale = 4096) est actif, la requête renvoie la valeur +4096.

### STATus:QUESTIONable:ENABLE <valeur\_activation>

#### STATus:QUESTIONable:ENABLE?

Active les bits du **registre d'activation** du groupe de **registres des données suspectes**. Les bits sélectionnés sont ensuite reportés dans l'octet d'état.

Paramètre	Renvoi type
Valeur décimale égale à la somme des valeurs décimales des bits du registre.	+512
Activer le bit 9 (valeur 512) dans le registre d'activation : STAT:QUES:ENAB 512	

- Utilisez <valeur\_activation> pour spécifier les bits à reporter dans l'octet d'état. La valeur spécifiée correspond à la somme binaire pondérée des bits du registre à activer. Par exemple, pour activer le bit 5 (valeur 32) et le bit 9 (valeur 512), cette valeur décimale est 544.
- Registre d'activation effacé par :
  - STATus:Questionable:ENABLE 0
  - **STATus:PRESet**
  - Une remise sous tension (sauf si **\*PSC** est réglé sur 0)
- La commande **\*CLS** efface le registre des événements, mais pas le registre d'activation.
- La commande **\*RST** n'affecte pas ce registre.
- La requête lit le registre d'activation et renvoie une valeur décimale égale à la somme binaire pondérée de tous les bits actifs du registre.. Par exemple, si le bit 0 (valeur 1) et le bit 1 (valeur 2) sont activés, la requête renvoie la valeur +3.

#### STATus:QUESTIONable[:EVENT]?

Recherche le **groupe de registres des données suspectes** dans le registre des événements. Ce registre est en lecture seule ; les bits sont effacés lorsque vous le lisez.

Paramètre	Renvoi type
(aucun)	+512
Lire le registre des événements (bit 9 actif) : STAT:QUES?	

- Lorsqu'un bit est actif, il demeure dans cet état jusqu'à son effacement par cette requête ou la commande **\*CLS**.
- Les commandes **\*RST**, **STATus:PRESet** et **\*PSC** n'ont aucun impact sur ce registre.
- La requête lit les événements de registre et renvoie une valeur décimale égale à la somme binaire pondérée de tous les bits actifs du registre.. Par exemple, si le bit 1 (valeur = 2) et le bit 9 (valeur = 512) sont actifs, la requête renvoie la valeur +514.

## Présentation du sous-système SUM

Le sous-système SUM ajoute un signal de source de modulation au signal principal d'une voie. Il permet de générer un signal à deux fréquences porteuses sur une voie ou d'ajouter du bruit à un signal principal. La fonction SUM utilise les **mêmes sources secondaires** que les sous-systèmes de modulation.

Une seule modulation ou fonction SUM peut être active sur une voie à un instant donné ; vous ne pouvez donc pas ajouter du bruit à un signal FM à l'aide d'une seule voie. Pour ce fonctionnement, utilisez la commande **COMBine:FEED** qui groupe les deux voies d'un instrument 2 voies sur le connecteur de sortie d'une voie.

Lorsque des signaux sont ajoutés :

- Leur amplitude en crête ne peut pas être supérieure aux caractéristiques nominales de sortie de l'instrument.
- Aucune autre modulation interne ou externe n'est possible sur cette voie.

Vous pouvez configurer la phase entre le signal principal et le signal **SUM** en envoyant la commande **SOURce[1|2]:PHASe:SYNChronize** après avoir configuré les fonctions du signal principal et du signal **SUM**. Sinon, la phase entre les deux signaux est arbitraire.

### REMARQUE

Si la source est l'autre voie, on observe un retard significatif (pouvant atteindre 350 ns) par rapport au signal porteur, même après PHAS:SYNC. Utilisez la fonction Combine pour l'autre voie chaque fois que possible.

## Exemple

Pour créer un signal SUM :

1. **Configurez le signal porteur** : Utilisez les commandes **FUNction**, **FREQuency**, **VOLTage** et **VOLTage:OFFSet** pour spécifier la fonction du signal, sa fréquence, son amplitude et sa tension résiduelle.
2. **Sélectionnez la source de somme** : L'instrument accepte une source de modulation interne ou externe (EXT, voie 1 ou voie 2). Sélectionnez la source de modulation à l'aide de la commande **SUM:SOURce**. *Pour une source de modulation externe, ignorez les opérations 3 et 4.*
3. **Configurez le signal de somme** : Utilisez les commandes **FUNction**, **FREQuency**, **VOLTage** et **VOLTage:OFFSet** pour configurer le signal de somme.
4. **Définissez le pourcentage d'amplitude à ajouter** : **SUM:AMPLitude**.
5. **Activez la modulation SUM** : **SUM:STATe:ON**.
6. **Si vous utilisez l'autre voie d'un instrument 2 voies, synchronisez les voies** : **PHASe:SYNChronize**.

Le code suivant produit l'image d'oscilloscope illustrée ci-dessous.

```
SOURce1:FUNction RAMP
SOURce1:FREQuency +2000,0
SOURce1:VOLTage +1,0
SOURce1:VOLTage:OFFS +0,0
SOURce1:FUNction:RAMP:SYMMetry +50,0
SOURce2:FUNction SQU
SOURce2:FREQuency +4000.0
SOURce2:VOLTage +1,0
SOURce2:VOLTage:OFFS +0,0
SOURce1:SUM:AMPLitude +50,0
SOURce1:SUM:SOURce CH2
SOURce1:SUM:STATE 1
SOURce1:PHASe:SYNC
OUTPut1 1
OUTPut2 1
```

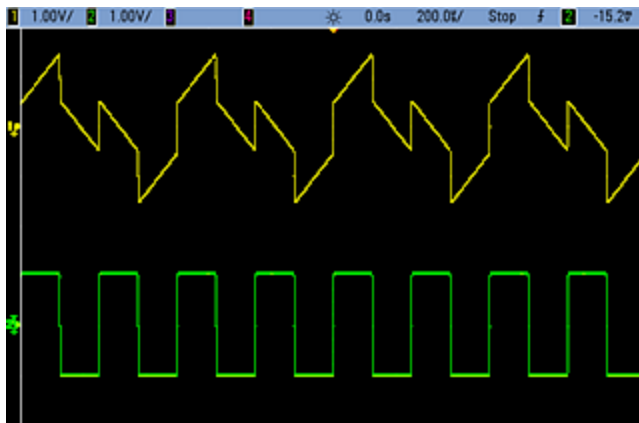

[SOURce[1|2]:]SUM:AMPLitude {<amplitude>|MINimum|MAXimum|DEFault}  
[SOURce[1|2]:]SUM:AMPLitude? [{MINimum|MAXimum}]

Définit la profondeur de modulation interne (ou « taux de modulation ») en pourcentage.

Paramètre	Renvoi type
Amplitude souhaitée du signal SUM en pourcentage de l'amplitude du signal porteur, de 0 à 100 ; 0,1 par défaut	+3,200000000000000E+00
Régler l'amplitude du signal SUM interne sur 1,0 % de l'amplitude du signal : SUM:AMPL 1,0 PHAS:SYNC  Régler l'amplitude du signal SUM interne de la voie 2 sur 0,15 % de l'amplitude du signal : SOUR2:SUM:AMPL 0,15	

- Vous pouvez configurer la phase entre le signal principal et le signal **SUM** en envoyant la commande **SOURce[1|2]:PHASe:SYNChronize** après avoir configuré les fonctions du signal principal et du signal **SUM**. Sinon, la phase entre les deux signaux est arbitraire.
- La sortie additionnée ne peut pas être supérieure la sortie maximale  $\pm 5$  V (dans une charge de 50  $\Omega$ ).
- Si vous sélectionnez la source SUM externe (**SUM:SOURce EXTernal**), le signal porteur est ajouté au signal externe. Le signal de somme est le signal  $\pm 5$  V sur le connecteur (éventuellement  $\pm 1$  V sur la série 33600) sur le connecteur **Modulation In** de la face arrière. Par exemple, si l'amplitude d'un signal porteur sinusoïdal est configurée avec 4 Vpp et si vous réglez l'amplitude de la somme sur 20 % (soit une contribution maximale de la somme égale à 800 mVpp) à l'aide de la commande SUM:AMPLitude, lorsque le signal EXT est à +5 V (éventuellement +1 V sur la série 33600), l'amplitude maximale de la sortie du signal additionné est égale à 4,8 Vpp. Lorsque le signal modulant est à -5 V (éventuellement -1 V sur la série 33600), l'amplitude minimale du signal additionné est égale à -4,8 Vpp. Une entrée de modulation de 0 V entraîne un signal égal à l'amplitude du signal porteur.

[SOURce[1|2]:]SUM:INTernal:FREQuency {< fréquence>|MINimum|MAXimum|DEFault}  
[SOURce[1|2]:]SUM:INTernal:FREQuency? [{MINimum|MAXimum}]

Définit la fréquence du signal de somme lorsque la source Sum interne est sélectionnée (SUM:SOURce:INTernal). Le signal utilisé comme source modulante fonctionne à cette fréquence dans les limites de fréquence de ce signal.

Paramètre	Renvoi type
1 µHz à la <b>valeur maximale autorisée pour la fonction interne</b> . Par défaut, 100 Hz	+1,0000000000000000E-06
<p>La commande suivante définit la fréquence du signal Sum à 10 kHz sur la voie 2 :  SOUR2:SUM:INT:FREQ 10000</p> <p>SOUR2:PHAS:SYNC La commande suivante définit la fréquence du signal Sum à 1 µHz sur la voie 1 :  SUM:INT:FREQ MIN  PHAS:SYNC</p>	

- Vous pouvez configurer la phase entre le signal principal et le signal **SUM** en envoyant la commande **SOURce[1|2]:PHASe:SYNChronize** après avoir configuré les fonctions du signal principal et du signal **SUM**. Sinon, la phase entre les deux signaux est arbitraire.
- Lorsque vous sélectionnez un signal arbitraire comme source modulante, la fréquence devient la fréquence du signal arbitraire, qui est basée sur la fréquence d'échantillonnage et le nombre de points présents dans le signal arbitraire.
- Lorsque vous utilisez un signal arbitraire comme source modulante, la modification de ce paramètre se répercute sur les métadonnées en mémoire cache représentant la fréquence d'échantillonnage du signal arbitraire. Vous pouvez également modifier la fréquence modulante d'un signal arbitraire à l'aide des commandes **FUNction:ARbitrary:FREQuency**, **FUNction:ARbitrary:PERiod** et **FUNction:ARbitrary:SRATE**. Ces commandes et la commande de la fréquence de modulation sont directement couplées afin de maintenir exactement le même comportement du signal arbitraire que lors de sa dernière lecture. Si vous désactivez ultérieurement la modulation et sélectionnez le même signal arbitraire, sa fréquence d'échantillonnage (et la fréquence correspondante en fonction du nombre de points) sera la même que lors de sa lecture comme source de modulation.
- Si la fonction interne est TRiangle, UpRamp ou DnRamp, la fréquence maximale est limitée à 200 kHz sur la série 33500 ou à 800 kHz sur la série 33600. Si la fonction interne est PRBS, la fréquence fait référence au débit binaire et est limitée, **comme indiqué ici**.



[SOURce[1|2]:]SUM:INTernal:FUNCTion <fonction>

[SOURce[1|2]:]SUM:INTernal:FUNCTion?

Sélectionne le signal de somme (signal additionné au signal principal).

Paramètre	Renvoi type
{SINusoid SQUare RAMP NRAMp TRIangle NOISe PRBS ARB}, SINusoid par défaut	SIN, SQU, RAMP, NRAM, TRI, NOIS, PRBS ou ARB
Sélectionner un signal sinusoïdal comme forme du signal de somme pour la voie 2 : SOUR2:SUM:INT:FUNC SIN	

- Vous pouvez configurer la phase entre le signal principal et le signal **SUM** en envoyant la commande **SOURce[1|2]:PHASe:SYNChronize** après avoir configuré les fonctions du signal principal et du signal **SUM**. Sinon, la phase entre les deux signaux est arbitraire.
- Cette commande s'applique uniquement avec une source Sum interne (**SUM:SOURce INTernal**).
- Vous ne pouvez pas utiliser la fonction SUM lorsqu'un signal CC est le signal porteur.
- Un signal arbitraire ne peut pas à la fois être un signal porteur et un signal Sum.

Le tableau suivant indique les signaux porteurs qu'il est possible d'associer à des fonctions internes.

Signal modulant							
Signal porteur	Sinusoïdal	Carré	Tri / Rampe	Bruit	PRBS	Arb	Externe
Sinusoïdal	•	•	•	•	•	•	•
Carré/Impulsion	•	•	•	•	•	•	•
Rampe/triangle	•	•	•	•	•	•	•
Bruit gaussien	•	•	•		•	•	•
PRBS	•	•	•	•		•	•
Arbitraire	•	•	•	•	•		•
Arbitraire séquencé	•	•	•	•	•		•

[SOURce[1|2]:]SUM:SOURce {INTernal|EXTernal|CH1|CH2}  
[SOURce[1|2]:]SUM:SOURce?

Sélectionne la source du signal de somme.

Paramètre	Renvoi type
{INTernal EXTernal CH1 CH2}, INTernal par défaut	INT, EXT, CH1 ou CH2
Configurer la source Sum sur EXTernal : SUM:SOUR EXT	

- Vous pouvez configurer la phase entre le signal principal et le signal **SUM** en envoyant la commande **SOURce[1|2]:PHASe:SYNChronize** après avoir configuré les fonctions du signal principal et du signal **SUM**. Sinon, la phase entre les deux signaux est arbitraire.
- **SUM:SOURce EXTernal** : le signal externe est ajouté au signal porteur. L'amplitude et la polarité du signal Sum sont déterminées par le niveau de signal  $\pm 5$  V sur le connecteur **Modulation In** de la face arrière (éventuellement  $\pm 1$  V sur la série 33600). Par exemple, si vous avez configuré l'amplitude SUM sur 2,0 Vpp à l'aide de la commande **SUM:AMPLitude**, lorsque le signal EXT est à +5 V, le signal Sum est à 2 Vpp. Lorsque le signal modulant est à -5 V, le signal Sum sera à l'amplitude maximale et la polarité sera inversée.

[SOURce[1|2]:]SUM:STATe {ON|1|OFF|0}  
[SOURce[1|2]:]SUM:STATe?

Active/désactive la fonction SUM.

Paramètre	Renvoi type
{ON 1 OFF 0}, OFF par défaut	0 (OFF) ou 1 (ON)
Activer SUM : SUM:STAT ON	

- Vous pouvez configurer la phase entre le signal principal et le signal **SUM** en envoyant la commande **SOURce[1|2]:PHASe:SYNChronize** après avoir configuré les fonctions du signal principal et du signal **SUM**. Sinon, la phase entre les deux signaux est arbitraire.
- Pour éviter plusieurs modifications des signaux, activez la fonction SUM après avoir configuré les autres paramètres de somme.
- Vous ne pouvez activer qu'un seul mode de modulation à la fois.
- L'instrument ne permet pas d'activer la fonction SUM lorsque le mode balayage ou rafale est activé. Lorsque vous activez la fonction SUM, le mode balayage ou rafale est désactivé.
- Lorsque SUM:STATe est activé, l'amplitude de la somme augmentée de l'amplitude du signal porteur ne peut être supérieure aux limites programmées ou aux caractéristiques nominales de l'instrument. Si l'activation de SUM:STATe provoque un dépassement des limites ou des caractéristiques nominales de sortie, SUM:STATe est désactivé (OFF) et l'instrument signale une erreur de conflit de paramètres.

## Présentation du sous-système SWEep

Pour créer une fréquence de balayage :

1. **Sélectionnez la forme, l'amplitude et la tension résiduelle du signal** : Utilisez la commande **APPLY** ou les commandes équivalentes **FUNCTION**, **FREQUENCY**, **VOLTage** et **VOLTage:OFFSet** pour sélectionner la fonction, la fréquence, l'amplitude et la tension résiduelle. Vous pouvez sélectionner un signal sinusoïdal, carré, triangulaire ou arbitraire, une rampe ou un train d'impulsions (les signaux PRBS et CC et le bruit ne sont pas autorisés).
2. **Sélectionnez les limites de la fréquence de balayage** : **FREQUENCY:START** et **FREQUENCY:STOP**, ou **FREQUENCY:CENTER** et **FREQUENCY:SPAN**
3. **Sélectionnez le mode de balayage linéaire ou logarithmique** : **SWEep:SPACing**
4. **Configurez le temps de balayage** : **SWEep:TIME**
5. **Configurez les temps de maintien et de retour du balayage** : **SWEep:HTIME** et **SWEep:RTIME**
6. **Sélectionnez la source de déclenchement du balayage** : **TRIGger[1|2]:SOURce**
7. **Configurez la fréquence du marqueur (option)** : **MARKer:FREQUENCY**
8. **Activez le balayage** : **SWEep:STATe ON**

Le code suivant produit le signal indiqué ci-dessous.

```
SOURce1:FUNCTION SINE
SOURce1:FREQUENCY +2,0E+03
SOURce1:FREQUENCY:START +2,0E+03
SOURce1:FREQUENCY:STOP +6,0E+03
SOURce1:VOLTage +1,0
SOURce1:VOLTage:OFFS +0,0
SOURce1:SWEep:TIME +5,0E-03
TRIGger1:SOURce IMM
SOURce1:FREQUENCY:MODE SWE
OUTPut1 1
```

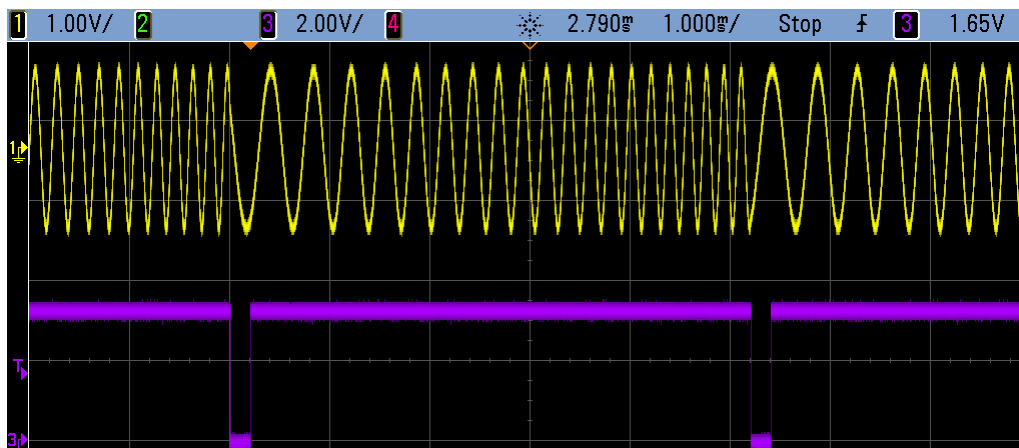

[SOURCE[1|2]:]SWEep:HTIME {< temps\_maintien >|MINimum|MAXimum|DEFAULT}  
 [SOURCE[1|2]:]SWEep:HTIME? [{MINimum|MAXimum}]

Définit la durée en secondes pendant laquelle le balayage se maintient (en pause) à la fréquence finale avant de revenir à la fréquence initiale.

Paramètre	Renvoi type
0 à 3 600, 0 par défaut	+3,4000000000000000E+00
Régler le temps de maintien du balayage sur 3,4 secondes : SWE:HTIM 3,4	

[SOURCE[1|2]:]SWEep:RTIME {< temps\_retour >|MINimum|MAXimum|DEFAULT}  
 [SOURCE[1|2]:]SWEep:RTIME? [{MINimum|MAXimum}]

Définit la durée en secondes nécessaire pour que le balayage retourne de la fréquence finale à la fréquence initiale.

Paramètre	Renvoi type
0 à 3 600, 0 par défaut	+5,6000000000000000E+00
Régler le temps de retour du balayage sur 5,6 s : SWE:RTIM 5,6	

- Le balayage de retour est toujours linéaire, quel que soit le paramètre **SWEep:SPACing**.

[SOURCE[1|2]:]SWEep:SPACing {LINear|LOGarithmic}  
 [SOURCE[1|2]:]SWEep:SPACing?

Sélectionne le balayage linéaire ou logarithmique.

Paramètre	Renvoi type
{LINear LOGarithmic}, LIN par défaut	LIN ou LOG
Configurer le balayage logarithmique : SWE:SPAC LIN	

- **LINear** : la fréquence de sortie varie de façon linéaire (entre la fréquence initiale et la fréquence finale) pendant le balayage.
- **LOGarithmic** : la fréquence de sortie varie de façon logarithmique (entre la fréquence initiale et la fréquence finale) pendant le balayage.

[SOURCE[1|2]:]SWEep:STATe {ON|1|OFF|0}  
 [SOURCE[1|2]:]SWEep:STATe?

Active/désactive le balayage.

Paramètre	Renvoi type
{ON 1 OFF 0}, OFF par défaut	0 (OFF) ou 1 (ON)
Activer le balayage : SWE:STAT ON	

[SOURCE[1|2]:]SWEep:TIME {<secondes>|MINimum|MAXimum|DEFault}  
 [SOURCE[1|2]:]SWEep:TIME? [{MINimum|MAXimum}]

Définit la durée (en secondes) du balayage entre la fréquence initiale et la fréquence finale.

Paramètre	Renvoi type
1 ms à 250 000 s pour le balayage linéaire, jus- qu'à 500 s pour le balayage loga- rithmique ; 1 s par défaut	+2,500000000000000E+01
Régler le temps de balayage sur 25 s : SWE:TIME 25	

- L'instrument calcule le nombre de points dans le balayage en fonction du temps de balayage.

## Sous-système SYSTEM

Le sous-système SYSTEM gère l'enregistrement des états de l'instrument, le rappel après extinction, les conditions d'erreur, les autotests, le contrôle de l'écran de la face avant et la configuration de l'interface distante.

### REMARQUE

L'instrument utilise le port 5024 du réseau local pour les sessions Telnet SCPI et le port 5025 pour les sessions sur socket SCPI.

- **SYSTEM:BEEPer[:IMMediate]** - émet un signal sonore
- **SYSTEM:BEEPer:STATe {ON|1|OFF|0}** - active/désactive l'avertisseur sonore
- **SYSTEM:CLICk:STATe** - active/désactive le clic des touches
- **SYSTEM:COMMunicate:ENABle {ON|1|OFF|0}, <interface>** - active/désactive l'interface GPIB, USB et du réseau local, ainsi que les services distants
- **SYSTEM:COMMunicate:GPIB:ADDRess <adresse>** - affecte l'adresse GPIB (IEEE-488) de l'instrument

- **SYSTem:DATE** <aaa>, <mm>, <jj> - règle la date de l'horloge système
- **SYSTem:ERRor?** - lit et efface une erreur dans la file des erreurs
- **SYSTem:LIcense:CATalog?** - indique les options sous licence installées
- **SYSTem:LIcense:DElete** "<nom\_option>" - supprime une licence
- **SYSTem:LIcense:DElete:ALL** - supprime toutes les licences
- **SYSTem:LIcense:DEscription?** "<nom\_option>" - renvoie la description d'une options sous licence
- **SYSTem:LIcense:ERRor?** - répertorie les erreurs générées pendant l'installation des licences
- **SYSTem:LIcense:ERRor:COUNt?** - renvoie le nombre d'erreurs générées pendant l'installation des licences
- **SYSTem:LIcense:INSTall** "<fichier>" - installe des licences à partir d'un fichier ou d'un dossier  
**SYSTem:LIcense:INSTall?** "<option>" - indique si une licence est installée
- **SYSTem:LOCK:NAME?** - renvoie l'interface d'E/S active
- **SYSTem:LOCK:OWNer?** - renvoie l'interface qui comporte le verrouillage
- **SYSTem:LOCK:RELease** - libère le verrouillage et diminue le nombre de verrouillage d'une unité
- **SYSTem:LOCK:REQuest?** - demande le verrouillage de l'interface active
- **SYSTem:SECurity:IMMediate** - nettoie la mémoire de l'appareil accessible à l'utilisateur
- **SYSTem:TIME** <hh>, <mm>, <ss> - règle l'heure de l'horloge système
- **SYSTem:VERsion?** - renvoie la version du langage SCPI utilisé par l'instrument

#### **SYSTem:BEEPer[:IMMediate]**

Émet un signal sonore.

Paramètre	Renvoi type
(aucun)	(aucun)
Émettre un signal sonore unique : SYST:BEEP	

- L'envoi d'un signal sonore programmé peut être utile pour le développement et la mise au point de programmes.
- Cette commande remplace l'état actuel de l'avertisseur sonore (SYSTem:BEEPer:STATe). Autrement dit, vous pouvez émettre un signal sonore, même si l'avertisseur sonore est désactivé.

**SYSTem:BEEPer:STATe {ON|1|OFF|0}**

**SYSTem:BEEPer:STATe?**

Active ou désactive le signal émis lorsqu'une erreur est générée depuis la face avant ou l'interface distante.

Paramètre	Renvoi type
{ON 1 OFF 0}, ON par défaut	0 (OFF) ou 1 (ON)
Désactiver l'état de l'avertisseur sonore : SYST:BEEP:STAT OFF	

- La désactivation de l'avertisseur sonore ne provoque pas celle du clic des touches de la face avant.
- Un signal sonore est toujours émis (même si l'avertisseur sonore est désactivé) lorsque la commande **SYSTem:BEEPer** est envoyée.
- Ce paramètre est non volatile ; il n'est pas modifié par une remise sous tension ou l'exécution de la commande **\*RST**.

**SYSTem:CLICk:STATe {ON|1|OFF|0}**

**SYSTem:CLICk:STATe?**

Désactive/active le clic entendu lorsqu'une touche ou une touche du fonction de la face avant est enfoncée.

Paramètre	Renvoi type
{ON 1 OFF 0}, ON par défaut	0 (OFF) ou 1 (ON)
Désactiver les clics du clavier : SYST:CLIC:STAT OFF	

- Cette commande n'affecte pas l'avertisseur sonore qui indique des erreurs.
- Ce paramètre est non volatile ; il n'est pas modifié par une remise sous tension (**\*RST**).

**SYSTem:COMMunicate:ENABle {ON|1|OFF|0}, <interface>**

**SYSTem:COMMunicate:ENABle? <interface>**

Active/désactive l'interface distante du réseau local, GPIB ou USB. Active/désactive également les services distants disponibles, tels que Sockets, Telnet, VXI11, et l'interface Web intégrée.

Paramètre	Renvoi type
{ON 1 OFF 0}, ON par défaut pour toutes les interfaces	0 (OFF) ou 1 (ON)
{GPIB USB LAN SOCKets TELNet VXI11 WEB}	
Désactiver l'interface USB : SYST:COMM:ENAB OFF,USB  Renvoyer l'état de l'interface USB : SYST:COMM:ENAB? USB	

**REMARQUE**

Lorsque vous désactivez ou réactivez une interface ou un service de réseau local, vous devez remettre l'instrument sous tension afin d'activer le nouveau réglage.

- Si vous désactivez l'interface du réseau local, tous les services réseau associés ne démarrent pas lorsque vous mettez l'instrument sous tension.
- Ce paramètre est non volatile ; il n'est pas modifié par une remise sous tension ou l'exécution de la commande **\*RST**.
- **SYSTem:SECurity:IMMEDIATE** active toutes les interfaces.

**SYSTem:COMMunicate:GPIB:ADDRess <adresse>**

**SYSTem:COMMunicate:GPIB:ADDRess?**

Affecte l'adresse GPIB (IEEE-488) de l'instrument qui s'affiche à la mise sous tension. Chaque périphérique connecté à l'interface GPIB doit avoir une adresse unique.

Paramètre	Renvoi type
0 à 30, 10 par défaut	+15
Définir l'adresse GPIB sur 15 : SYST:COMM:GPIB:ADDR 15	

- L'interface GPIB de votre ordinateur ne doit pas être en conflit avec un instrument sur le bus de l'interface.
- Ce paramètre est non volatile ; il n'est pas modifié par une remise sous tension ou l'exécution de la commande **\*RST**.
- **SYSTem:SECurity:IMMEDIATE** définit l'adresse GPIB sur 10.
- L'instrument doit être remis sous tension pour que cette commande prenne effet.



**SYSTem:DATE** <aaaa>, <mm>, <jj>

**SYSTem:DATE?**

Règle la date de l'horloge système.

Paramètre	Renvoi type
<aaaa> 2000 à 2100 <mm> 1 à 12 <jj> 1 à 31	+2011,+7,+26
Régler la date système au 26 juillet 2011 : SYST:DAT 2011,7,26	

**SYSTem:ERRor?**

Lit et efface une erreur dans la file d'erreurs.

Paramètre	Renvoi type
(aucun)	-113,"Undefined header"
Lire et effacer la première erreur de la file d'erreurs : SYST:ERR?	

- Il est possible d'enregistrer jusqu'à 20 erreurs de syntaxe de commande ou matérielles dans chaque liste des erreurs des interfaces (une pour chaque erreur GPIB, USB, VXI-11 et Telnet/Sockets).
- Erreur de récupération « premier entré/premier sorti » ; ces erreurs sont effacées après leur lecture. L'instrument émet un signal sonore chaque fois qu'une erreur se produit (sauf si cette fonction est désactivée par la commande **SYSTem:BEEPer:STATe OFF**).
- Si plus de 20 erreurs se sont produites, la dernière erreur enregistrée (la plus récente) est remplacée par -350,"Error queue overflow". Aucune erreur supplémentaire n'est enregistrée jusqu'à ce que vous en supprimiez dans la file. Si aucune erreur ne s'est produite depuis la dernière consultation de la file d'erreurs, l'instrument affiche le message suivant : +0,"No error".
- La file d'erreurs est effacée par la commande \*CLS ou lorsque l'instrument est remis sous tension. Elle n'est pas effacée par la commande \*RST.
- Les erreurs présentent le format suivant (la chaîne d'erreur peut contenir jusqu'à 255 caractères) :

<code d'erreur>,<chaîne d'erreur>

Où :

<code d'erreur> = code à 3 chiffres, parfois précédé d'un tiret

<chaîne d'erreur> = chaîne de caractères ASCII entre guillemets contenant jusqu'à 255 caractères

## Options sous licence

Les commandes suivantes sont associées aux options sous licence. Les options sous licence sont indiquées ci-dessous.

Code de l'option	Description
ARB	Signaux arbitraires
BW30	Augmenter la bande passante à 30 MHz (série 33500)
BW120	Augmenter la bande passante à 120 MHz (série 33600)
IQP	Lecteur IQ (instruments 2 voies uniquement)
MEM	Mémoire de signaux arbitraires de 16 Méch (série 33500) ou de 64 Méch (série 33600)
SEC	Activer la sécurité NISPOM et des fichiers

### SYSTem:LICense:CATalog?

Renvoie une la liste séparée par des virgules des **options sous licence** installées.

Paramètre	Renvoi type
(aucun)	"SEC", "IQP", "MEM"
Renvoyer les options actuellement sous licence : SYST:LIC:CAT?	

- Seules les options nécessitant une licence sont renvoyées.

### SYSTem:LICense:DElete "<nom\_option>"

Supprime une licence.

**ATTENTION** Prenez des précautions avant d'exécuter cette commande. La seule manière d'annuler la suppression d'une licence est de réinstaller cette dernière.

Paramètre	Renvoi type
{ARB BW30 BW120 IQP MEM SEC}	(aucun)
Supprimer une licence pour IQ Player : SYST:LIC:DEL "IQP"	

- Les noms d'options valides sont des chaînes de caractères entre guillemets qui représentent les **options sous licence** installées. Elles sont facilement identifiables à l'aide de la commande **SYSTem:LICense:CATalog?**.

## SYSTem:LICense:DELeTe:ALL

Supprime toutes les licences.

**ATTENTION** Prenez des précautions avant d'exécuter cette commande. La seule manière d'annuler la suppression d'une licence est de réinstaller cette dernière.

Paramètre	Renvoi type
(aucun)	(aucun)
Supprimer toutes les licences : SYST:LIC:DEL:ALL	

## SYSTem:LICense:DESCRiption? "<nom\_option>"

Renvoie une description d'une option donnée, que sa licence soit ou non active.

Paramètre	Renvoi type
Consultez la liste des options sous licence	"Extended Memory Option: 16 MSa/channel waveform memory"
Renvoyer la description de l'option 002 : SYST:LIC:DESC? "MEM"	

- Les noms d'options sont des chaînes de caractères entre guillemets qui représentent les options susceptibles d'être actives. Les licences installées sont identifiables à l'aide de la commande **SYSTem:LICense:CATalog?**.

## SYSTem:LICense:ERRor?

Renvoie une chaîne de caractères de toutes les erreurs générées par la commande **SYSTem:LICense:INSTall**.

Paramètre	Renvoi type
(aucun)	#279File: MyFile.lic<CR><LF>[Ignored - The license file is not formatted correctly.]<CR><LF>
Renvoyer la chaîne d'erreur d'installation de la licence : SYST:LIC:ERR?	

- Cette chaîne de caractères peut contenir jusqu'à 2 096 caractères.
- Renvoie un bloc de longueur définie contenant un texte ASCII sur plusieurs lignes, y compris les retours chariot et les retours à la ligne.

## SYSTem:LIcense:ERRor:COUNT?

Renvoie le nombre d'erreurs des licences générées par la commande **SYSTem:LIcense:INSTall**.

Paramètre	Renvoi type
(aucun)	+0
Renvoyer le nombre d'erreurs de licence : SYST:LIC:ERR:COUN?	

## SYSTem:LIcense:INSTall "<fichier>"

### SYSTem:LIcense:INSTall? "<option>"

Cette commande installe toutes les licences à partir d'un fichier de licence spécifié ou de tous les fichiers de licences dans le dossier spécifié. Cette requête renvoie 0 ou 1 pour indiquer si la licence spécifiée est installée.

Paramètre	Renvoi type
<dossier> peut être n'importe quel nom de dossier valide. Le dossier par défaut est le dossier racine d'un périphérique de stockage USB de la face avant. <fichier> peut être n'importe quel nom de fichier de licence valide. <option> est l'une des <b>options sous licence</b>	0 (licence non installée) ou 1 (licence installée)
Installer des licences à partir d'un fichier : SYST:LIC:INSTALL "USB:\33522B_LICENSE071.lic"	

- Les fichiers de licence doivent porter l'extension « .lic ».
- Le format de <fichier> est « [*<lecteur>*:<chemin>]<nom\_fichier> », où <lecteur> peut être INTERNAL ou USB et <chemin> doit être le chemin d'accès absolu au dossier.
  - INTERNAL spécifie le système de fichiers flash interne. USB désigne un périphérique de stockage USB sur la face avant.
  - Si <lecteur>:<chemin> n'est pas fourni, le dossier spécifié par la commande MMEMory:CDIRectory est utilisé.
  - Les chemins d'accès absolus commencent par « \ » ou « / » au dossier racine <lecteur>.
  - Les noms de dossiers et de fichiers ne peuvent pas contenir les caractères suivants : \ / : \* ? " < > |
  - La combinaison du nom du dossier et du fichier ne peut pas contenir plus de 240 caractères.
  - Le dossier spécifié doit exister, et ne peut pas être masqué ou un dossier système.

## SYSTem:LOCK:NAME?

Renvoie l'interface d'E/S active (l'interface d'E/S utilisée par l'ordinateur effectuant la requête).

Paramètre	Renvoi type
(aucun)	"LAN169.254.149.35"
Reportez-vous à la section <a href="#">Exemples de verrouillage des interfaces</a>	

- Après avoir utilisé cette commande pour déterminer le nom de l'interface utilisée, utilisez la commande SYSTem:LOCK:OWNer? pour déterminer l'interface verrouillée, le cas échéant.
- Renvoie « USB », « VXI11 », « GPIB » ou « LAN <Adresse IP> », en indiquant l'interface d'E/S utilisée par l'ordinateur effectuant la requête.

## SYSTem:LOCK:OWNer?

Renvoie l'interface d'E/S actuellement verrouillée.

Paramètre	Renvoi type
(aucun)	"LAN169.254.149.35"
Reportez-vous à la section <a href="#">Exemples de verrouillage des interfaces</a>	

- Lorsqu'un verrouillage est actif, le bit 10 du registre de fonctionnement standard est actif ([STATus:OPERation:CONDition?](#)). Lorsque le verrouillage est débloqué sur toutes les interfaces d'E/S, ce bit est effacé.
- Renvoie « USB », « VXI11 », « GPIB » ou « LAN <Adresse IP> », en indiquant l'interface d'E/S actuellement verrouillée. Si aucune interface n'est verrouillée, « NONE » est renvoyée.

## SYSTem:LOCK:RELease

Diminue d'une unité le nombre de verrouillages et peut libérer l'interface d'E/S à partir de la quelle la commande est exécutée.

Paramètre	Renvoi type
(aucun)	(aucun)
Reportez-vous à la section <a href="#">Exemples de verrouillage des interfaces</a>	

- Lorsqu'un verrouillage est actif, le bit 10 du registre de fonctionnement standard est actif ([STATus:OPERation:CONDition?](#)). Lorsque le verrouillage est débloqué sur toutes les interfaces d'E/S, ce bit est effacé.

## SYSTem:LOCK:REQuest?

Demande le verrouillage de l'interface d'E/S active. Cette commande permet de verrouiller la configuration de l'instrument ou de partager l'instrument avec d'autres ordinateurs.

Paramètre	Renvoi type
(aucun)	0 (refusé) ou 1 (accordé)
Reportez-vous à la section <a href="#">Exemples de verrouillage des interfaces</a>	

- Les demandes de verrouillage peuvent être imbriquées ; chaque demande augmente le nombre de verrouillages d'une unité. Pour chaque demande, vous avez besoin d'une libération (SYSTem:LOCK:RELease) de la même interface d'E/S.
- Les verrouillages sont gérés au niveau des interfaces d'E/S (USB, réseau local, etc.) ; vous êtes responsable de la coordination entre les threads et/ou les programmes sur cette interface.
- Lorsqu'une demande est accordée, seules les sessions d'E/S de l'interface actuelle sont autorisées à modifier l'état de l'instrument. Vous pouvez uniquement demander la configuration de l'instrument à partir des autres interfaces d'E/S.
- Les sessions sur le réseau local sont automatiquement libérées lorsqu'un réseau local est détecté.
- L'accord d'un verrouillage active le bit 10 du registre de fonctionnement standard ([STATus:OPERation:CONDition?](#)).

## Exemples de verrouillage des interfaces

Les commandes suivantes illustrent leur utilisation.

État initial = déverrouillé, nombre = 0

```
<FROM USB> SYST:LOCK:REQ? renvoie 1 (requête réussie)
```

État = verrouillé, nombre = 1

```
<FROM LAN> SYST:LOCK:REQ? renvoie la valeur 0, car  
l'interface USB est verrouillée
```

État = verrouillé, nombre = 1

```
<FROM USB> SYST:LOCK:REQ? renvoie la valeur 1 (requête  
réussie)
```

État = verrouillé, nombre = 2

```
<FROM USB> SYST:LOCK:REL
```

État = verrouillé, nombre = 1

```
<FROM USB> SYST:LOCK:REL
```

État = déverrouillé, nombre = 0

Notez que pour chaque demande de verrouillage réussie, un déblocage du verrouillage est nécessaire. Deux demandes requièrent deux déblocages.

## SYSTem:SECurity:IMMEDIATE

Assainit toute la mémoire de l'instrument accessible à l'utilisateur. Cette commande est conforme aux exigences du Chapitre 8 du National Instrument Security Program Operating Manual (NISPOM).

Paramètre	Renvoi type
(aucun)	(aucun)
Nettoyer toute la mémoire de l'appareil accessible à l'utilisateur : SYST:SEC:IMM	

### ATTENTION

Cette commande est recommandée pour les clients, tels que les sous-traitants militaires qui doivent satisfaire les conditions NISPOM. L'utilisation excessive de cette commande peut endommager prématurément la mémoire flash.

Cette commande détruit toutes les informations d'état définies par l'utilisateur, les signaux arbitraires définis par l'utilisateur et les paramètres d'E/ définis par l'utilisateur (par ex., adresse IP).

- Généralement utilisée avant de retirer un instrument d'une zone sécurisée.
- Initialise tous les réglages par défaut effectués en usine (\*RST).

## SYSTem:TIME <hh>, <mm>, <ss>

### SYSTem:TIME?

Règle l'heure de l'horloge système.

Paramètre	Renvoi type
<hh> 0 à 23 <mm> 0 à 59 <ss> 0 à 60	20,15,30.000
Régler l'heure système à 20:15:30 (8:15:30 PM) : SYST:TIM 20,15,30	

- Cette heure est utilisée pour l'horodatage des fichiers dans le système de mémoire de masse (MMEMory).

## SYSTem:VERSion?

Renvoie la version du langage SCPI (Standard Commands for Programmable Instruments) de l'instrument. Impossible à déterminer à partir de la face avant.

Paramètre	Renvoi type
(aucun)	1994.0
Renvoyer la version SCPI : SYST:VERS?	



## Configuration du réseau local

Configure l'instrument pour une utilisation à distance sur le réseau local (LAN).

**REMARQUE** L'instrument utilise le port 5024 du réseau local pour les sessions Telnet SCPI et le port 5025 pour les sessions sur socket SCPI.

### Notation par points

Les adresses notées par points (« nnn.nnn.nnn.nnn », où « nnn » représente la valeur d'un octet comprise entre 0 et 255) doivent être exprimées avec soin du fait que la plupart des logiciels des PC interprètent les octets avec des zéros initiaux comme des nombres en base 8. Par exemple, « 192.168.020.011 » est équivalent à la notation décimale « 192.168.16.9 », car « .020 » est interprété comme « 16 » en base 8 et « .011 » comme « 9 ». Pour éviter toute confusion, utilisez uniquement des valeurs décimales comprises entre 0 et 255 sans zéro au début.

**SYSTem:COMMunicate:LAN:CONTRol?**

Lit le numéro du port initial de connexion pour les communications par sockets. Cette connexion est utilisée pour envoyer et recevoir des commandes et des requêtes.

Paramètre	Renvoi type
(aucun)	5 000 (0 si l'interface ne prend pas en charge les sockets)
Renvoyer le numéro du port de connexion de contrôle : SYST:COMM:LAN:CONT?	

- Utilisez la connexion par socket des commandes pour envoyer la commande Device Clear à l'instrument ou détecter les événements de demande de service (Service Request - SRQ) en attente. La commande Device Clear est « DCL ».

**SYSTem:COMMunicate:LAN:DHCP {ON|1|OFF|0}**  
**SYSTem:COMMunicate:LAN:DHCP?**

Active/désactive l'utilisation du protocole DHCP par l'instrument. DHCP est l'abréviation de Dynamic Host Configuration Protocol ; il s'agit d'un protocole d'affectation d'adresses IP dynamiques IP aux périphériques sur un réseau. Avec l'adressage dynamique, un périphérique peut avoir une adresse IP différente chaque fois qu'il se connecte au réseau.

**ON** : l'instrument tente d'obtenir une adresse IP d'un serveur DHCP. Si l'instrument détecte un serveur DHCP, celui-ci lui attribue une adresse IP dynamique, un masque de sous-réseau et une passerelle par défaut.

**OFF ou DHCP non disponible** : l'appareil utilise l'adresse IP statique, le masque de sous-réseau et la passerelle par défaut à la mise sous tension.

**REMARQUE** Si vous modifiez ce paramètre, vous devez envoyer la commande **SYSTem:COMMunicate:LAN:UPDate** pour activer le nouveau paramètre.

Paramètre	Renvoi type
{ON 1 OFF 0}, ON par défaut	0 (OFF) ou 1 (ON)
Désactiver DHCP : SYST:COMM:LAN:DHCP OFF SYST:COMM:LAN:UPDate	

- La plupart des réseaux d'entreprise comportent un serveur DHCP.
- Si l'adresse réseau DHCP n'est pas attribuée par le serveur DHCP, une adresse IP statique est fournie après environ 2 minutes.
- Ce paramètre est non volatile ; il n'est pas modifié par une remise sous tension ou l'exécution de la commande **\*RST**.
- Activé lorsque l'instrument est expédié de l'usine ou après l'exécution de **SYSTem:SECurity:IMMEDIATE**.

**SYSTem:COMMunicate:LAN:DNS[1|2] "<adresse>"**  
**SYSTem:COMMunicate:LAN:DNS[1|2]? [{CURRENT|STATIC}]**

Affecte les adresses IP statiques des serveurs DNS (Domain Name System). Une adresse de serveur principale et secondaire peut être affectée. Pour plus d'informations, contactez votre administrateur réseau. Si le protocole DHCP est activé, celui-ci attribue automatiquement les adresses des serveurs DNS. Ces adresses DNS attribuées automatiquement sont prioritaires sur les adresses DNS statiques attribuées avec cette commande.

**REMARQUE** Si vous modifiez ce paramètre, vous devez envoyer la commande **SYSTem:COMMunicate:LAN:UPDate** pour activer le nouveau paramètre.

Paramètre	Renvoi type
Commande : « <b>nnn.nnn.nnn.nnn</b> », « 0.0.0.0 » par défaut Requête : {CURRENT STATIC}, CURRENT par défaut	"198.105.232.4"
Définir une adresse DNS principale statique : SYST:COMM:LAN:DNS "198.105.232.4" SYST:COMM:LAN:UPD	

- **CURRENT** : lit l'adresse actuellement utilisée par l'instrument.
- **STATIC** : lit l'adresse statique en mémoire non volatile. Cette adresse IP est utilisée si le protocole DHCP est désactivé ou indisponible.
- Ce paramètre est non volatile ; il n'est pas modifié par une remise sous tension ou l'exécution de la commande **\*RST**.
- Défini sur « 0.0.0.0 » par la commande **SYSTem:SECurity:IMMEDIATE**.

**SYSTem:COMMunicate:LAN:DOMain?**

Renvoie le nom de domaine du réseau local auquel l'instrument est connecté.

Paramètre	Renvoi type
(aucun)	« example.com »
Renvoyer le nom de domaine actuellement utilisé par l'instrument : SYST:COMM:LAN:DOM?	

- Si votre réseau dispose du système Dynamic Domain Name et si votre instrument utilise le protocole DHCP, le nom du domaine est enregistré avec le service DNS dynamique à la mise sous tension.
- Une chaîne vide ("") indique qu'aucun nom de domaine n'est attribué.

**SYSTem:COMMunicate:LAN:GATeway "<adresse>"**  
**SYSTem:COMMunicate:LAN:GATeway? [{CURRENT|STATIC}]**

Attribue une passerelle par défaut à l'instrument. L'adresse IP spécifiée configure la passerelle par défaut qui permet à l'instrument de communiquer avec des systèmes qui ne se trouvent pas sur le sous-réseau local. Il s'agit donc de la passerelle par défaut où les paquets envoyés sont destinés à un périphérique qui ne se trouve pas sur le sous-réseau local, comme déterminé par le masque de sous-réseau. Si le protocole DHCP est activé (SYSTem:COMMunicate:LAN:DHCP), la passerelle par défaut spécifiée n'est pas utilisée. Cependant, si le serveur DHCP ne parvient pas à attribuer une adresse IP valide, la passerelle configurée par défaut est utilisée. Pour plus d'informations, contactez votre administrateur réseau.

**REMARQUE** Si vous modifiez ce paramètre, vous devez envoyer la commande **SYSTem:COMMunicate:LAN:UPDate** pour activer le nouveau paramètre.

Paramètre	Renvoi type
Commande : « <b>nnn.nnn.nnn.nnn</b> », « 0.0.0.0 » par défaut Requête : {CURRENT STATIC}, CURRENT par défaut	"198.105.232.1"
Définir l'adresse de passerelle par défaut : SYST:COMM:LAN:GATEWAY "198.105.232.1" SYST:COMM:LAN:UPD	

- **CURRENT** : lit l'adresse actuellement utilisée par l'instrument.
- **STATIC** : lit l'adresse statique en mémoire non volatile. Cette adresse IP est utilisée si le protocole DHCP est désactivé ou indisponible.
- Défini sur « 0.0.0.0 » lorsque l'instrument est expédié de l'usine ou après l'exécution de **SYSTem:SECurity:IMMEDIATE**.

**SYSTem:COMMunicate:LAN:HOSTname "< nom >"**  
**SYSTem:COMMunicate:LAN:HOSTname? [{CURRENT|STATIC}]**

Attribue un nom d'hôte à l'instrument. Un nom d'hôte est la partie concernant l'hôte dans le nom du domaine qui est traduite en adresse IP. Si le système DNS dynamique est disponible sur votre réseau et si votre instrument utilise le protocole DHCP, le nom d'hôte est enregistré avec le service DNS dynamique à la mise sous tension. Si le protocole DHCP est activé (SYSTem:COMMunicate:LAN:DHCP), le serveur DHCP peut modifier le nom d'hôte spécifié.

**REMARQUE** Si vous modifiez ce paramètre, vous devez envoyer la commande **SYSTem:COMMunicate:LAN:UPDate** pour activer le nouveau paramètre.

Paramètre	Renvoi type
Chaîne pouvant contenir jusqu'à 15 caractères. Doit commencer par une lettre (A-Z) Peut contenir des lettres, des chiffres (0 à 9) et les traits d'union ("-").	« LAB1-33522A »
Définir un nom d'hôte : SYST:COMM:LAN:HOST "LAB1" SYST:COMM:LAN:UPD	

- Défini sur « A-33521A-nnnnn » ou « A-33522A-nnnnn », où nnnnn représente les 5 derniers chiffres du numéro de série de l'instrument à l'expédition de l'usine ou après l'exécution de la commande **SYSTem:SECurity:IMMEDIATE**.
- S'il n'existe pas de nom d'hôte, une chaîne vide ( "" ) est renvoyée.

**SYSTem:COMMunicate:LAN:IPADdress "<adresse>"**  
**SYSTem:COMMunicate:LAN:IPADdress? [{CURRENT|STATIC}]**

Attribue une adresse IP statique à l'instrument. Si le protocole DHCP est activé (SYSTem:COMMunicate:LAN:DHCP), l'adresse IP statique spécifiée n'est pas utilisée. Pour plus d'informations, contactez votre administrateur réseau.

**REMARQUE** Si vous modifiez ce paramètre, vous devez envoyer la commande **SYSTem:COMMunicate:LAN:UPDate** pour activer le nouveau paramètre.

Paramètre	Renvoi type
Commande : « <b>nnn.nnn.nnn.nnn</b> », « 0.0.0.0 » par défaut Requête : {CURRENT STATIC}, CURRENT par défaut	"169.254.149.35"
Définir une adresse IP statique : SYST:COMM:LAN:IPAD "169.254.149.35" SYST:COMM:LAN:UPD	

- CURRENT : lit l'adresse actuellement utilisée par l'instrument.
- STATic : lit l'adresse statique en mémoire non volatile. Cette adresse IP est utilisée si le protocole DHCP est désactivé ou indisponible.
- Ce paramètre est non volatile ; il n'est pas modifié par une remise sous tension ou l'exécution de la commande **\*RST**.
- Réglé sur «169.254.5.21 » lorsque l'instrument est expédié de l'usine ou après l'exécution de la commande **SYSTem:SECurity:IMMEDIATE**.

**SYSTem:COMMunicate:LAN:MAC?**

Lit l'adresse MAC (Media Access Control) de l'instrument.

**REMARQUE** Votre administrateur réseau peut avoir besoin de l'adresse MAC pour attribuer une adresse IP statique à ce périphérique.

Paramètre	Renvoi type
(aucun)	« 0030D3001041 »
Renvoyer l'adresse MAC : SYST:COMM:LAN:MAC?	

- L'adresse MAC porte également les noms suivants : adresse de la couche de liaison, adresse Ethernet (poste), LANIC ID ou adresse matérielle. Il s'agit d'une adresse non modifiable sur 48 bits attribué par le fabricant à chaque périphérique Internet unique.
- L'adresse MAC de l'instrument est attribuée en usine et ne peut pas être modifiée.
- Ce paramètre est non volatile ; il n'est pas modifié par une remise sous tension ou l'exécution de la commande **\*RST**.

**SYSTem:COMMunicate:LAN:SMASk "<masque>"**  
**SYSTem:COMMunicate:LAN:SMASk? [{CURRENT|STATIC}]**

Attribue un masque de sous-réseau à l'instrument. L'instrument utilise le masque de sous-réseau pour déterminer si une adresse IP cliente se trouve sur le même sous-réseau local que lui. Lorsque l'adresse IP d'un client se trouve sur un autre sous-réseau, tous les paquets doivent être envoyés à la passerelle par défaut. Pour plus d'informations, contactez votre administrateur réseau.

**REMARQUE** Si vous modifiez ce paramètre, vous devez envoyer la commande **SYSTem:COMMunicate:LAN:UPDate** pour activer le nouveau paramètre.

Paramètre	Renvoi type
Commande : « <b>nnn.nnn.nnn.nnn</b> », « 0.0.0.0 » par défaut Requête : {CURRENT STATIC}, CURRENT par défaut	"255.255.0.0"
Définir le masque de sous-réseau : SYST:COMM:LAN:SMAS "255.255.255.0" SYST:COMM:LAN:UPD	

- Si le protocole DHCP est activé (SYSTem:COMMunicate:LAN:DHCP), le masque de sous-réseau spécifié n'est pas utilisé. Cependant, si le serveur DHCP ne parvient pas à attribuer une adresse IP valide, l'instrument utilise le masque de sous-réseau AutoIP.
- La valeur « 0.0.0.0 » ou « 255.255.255.255 » indique que la fonction de sous-réseau n'est pas utilisée.
- Ce paramètre est non volatile ; il n'est pas modifié par une remise sous tension ou l'exécution de la commande **\*RST**.
- Le masque de sous-réseau est défini sur « 255.255.0.0 » lorsque l'instrument est expédié de l'usine ou après l'exécution de la commande SYSTem:SECurity:IMMEDIATE.
- CURRENT : lit l'adresse actuellement utilisée par l'instrument.
- STATIC : lit l'adresse statique en mémoire non volatile. Cette adresse IP est utilisée si le protocole DHCP est désactivé ou indisponible.

SYSTem:COMMunicate:LAN:TELNet:PROMpt "< chaîne de caractères>"  
SYSTem:COMMunicate:LAN:TELNet:PROMpt?

Configure l'invite affichée lorsque l'instrument communique via Telnet.

Paramètre	Renvoi type
Chaîne pouvant contenir jusqu'à 15 caractères	« Command »
Configurer l'invite de commandes : SYST:COMM:LAN:TELN:PROM "Command"	

- Une session Telnet est généralement initiée à partir d'un shell de l'ordinateur hôte :

```
telnet <adresse_IP> <port>
```

Par exemple : telnet 169.254.4.10 5024

Pour quitter une session Telnet, appuyez sur <Ctrl-D>.

- Ce paramètre est non volatile ; il n'est pas modifié par une remise sous tension ou l'exécution de la commande \*RST.
- Ce paramètre est défini sur « 33521A » (modèle 33521A), sur « 33522A » (modèle 33522A), sur « 33500 » (autres modèles de la série 33500) ou « 33600 » (modèles de la série 33600) lorsque l'instrument est expédié de l'usine ou après l'exécution de la commande SYSTem:SECurity:IMMEDIATE.

SYSTem:COMMunicate:LAN:TELNet:WMESsage "< chaîne de caractères>"  
SYSTem:COMMunicate:LAN:TELNet:WMESsage?

Configure le message d'accueil lorsque l'instrument communique via Telnet.

Paramètre	Renvoi type
Chaîne pouvant contenir jusqu'à 63 caractères	« Welcome to the Telnet Session »
Configurer un message d'accueil : SYST:COMM:LAN:TELN:WMES "Welcome to the Telnet Session"	

- Ce paramètre est non volatile ; il n'est pas modifié par une remise sous tension ou l'exécution de la commande \*RST.
- Ce paramètre est défini sur « Bienvenue sur le Générateur de signaux 33521A d'Keysight » (modèle 33521A), sur « Bienvenue sur le Générateur de signaux 33522A d'Keysight » (modèle 33522A), sur « Bienvenue sur le Générateur de signaux d'Keysight série 33500 » (autres modèles de la série 33500) ou « Bienvenue sur le Générateur de signaux d'Keysight série 33600 » (modèles de la série 33600) lorsque l'instrument est expédié de l'usine ou après l'exécution de la commande SYSTem:SECurity:IMMEDIATE.



## SYSTem:COMMunicate:LAN:UPDate

Enregistre les modifications des paramètres du réseau local en mémoire non volatile et redémarre le pilote du réseau local avec les nouveaux paramètres.

Paramètre	Renvoi type
(aucun)	(aucun)
(voir ci-dessous)	

- Cette commande doit être envoyée après avoir modifié les paramètres DHCP, DNS, de la passerelle, du nom d'hôte, d'adresse IP, du masque de sous-réseau ou WINS.
- Apportez toutes les modifications aux paramètres du réseau local avant d'envoyer cette commande.

### Exemple

Dans l'exemple suivant, l'instrument est configuré pour utiliser les paramètres réseau attribués de façon statique.

```
SYST:COMM:LAN:DHCP OFF
SYST:COMM:LAN:DNS "198.105.232.4"
SYST:COMM:LAN:DNS2 "198.105.232.5"
SYST:COMM:LAN:GATEWAY "198.105.232.1"
SYST:COMM:LAN:HOST "LAB1-33522A"
SYST:COMM:LAN:IPAD "198.105.232.101"
SYST:COMM:LAN:SMAS "255.255.255.0"
SYST:COMM:LAN:WINS "198.105.232.4"
SYST:COMM:LAN:WINS "198.105.232.5"
SYST:COMM:LAN:UPD
```

Dans l'exemple suivant, l'instrument est configuré pour revenir à l'utilisation du protocole DHCP.

```
SYST:COMM:LAN:DHCP ON
SYST:COMM:LAN:UPD
```

**SYSTem:COMMunicate:LAN:WINS[1|2] "<adresse>"**  
**SYSTem:COMMunicate:LAN:WINS[1|2]? [{CURRent|STATic}]**

Attribue les adresses IP statiques des serveurs WINS (Windows Internet Name System). Une adresse de serveur principale et secondaire peut être affectée. Pour plus d'informations, contactez votre administrateur réseau. Si le protocole DHCP est activé, celui-ci attribue automatiquement les adresses des serveurs WINS. Ces adresses WINS attribuées automatiquement sont prioritaires sur les adresses WINS statiques attribuées avec cette commande.

**REMARQUE** Si vous modifiez ce paramètre, vous devez envoyer la commande **SYSTem:COMMunicate:LAN:UPDate** pour activer le nouveau paramètre.

Paramètre	Renvoi type
Commande : « <b>nnn.nnn.nnn.nnn</b> », « 0.0.0.0 » par défaut Requête : {CURRent STATic}, CURRent par défaut	"198.105.232.4"
Définir une adresse WINS principale statique : SYST:COMM:LAN:WINS "198.105.232.4" SYST:COMM:LAN:UPD	

- Ces adresses WINS sont utilisées si DHCP est désactivé ou indisponible. Sinon, les adresses des serveurs WINS sont automatiquement attribuées par DHCP.
- Ce paramètre est non volatile ; il n'est pas modifié par une remise sous tension ou l'exécution de la commande **\*RST**.
- Défini sur « 0.0.0.0 » (aucun serveur) après l'exécution de la commande SYSTem:SECurity:IMMEDIATE.
- CURRent : lit l'adresse actuellement utilisée par l'instrument.
- STATic : lit l'adresse statique en mémoire non volatile. Cette adresse IP est utilisée si le protocole DHCP est désactivé ou indisponible.



[SOURce[1|2]:]TRACk {ON|OFF|INVerted}  
TRACK?

Provoque l'envoi du même signal de sortie ou d'un signal de polarité inversée sur les voies 1 et 2 d'un instrument 2 voies.

Paramètre	Renvoi type
{ON OFF INVerted}	ON, OFF ou INV
Configure la voie 2 pour envoyer un signal identique à celui de la voie 1 : TRACk ON	

- Copie tous les paramètres d'une voie nommée dans l'autre voie avec les exceptions indiquées ci-dessous. Cela comprend les paramètres de liste des fréquences et tous les signaux arbitraires chargés en mémoire.
- Avec l'option INVerted, l'amplitude de la voie suivante est inversée pour former un signal similaire à une sortie différentielle entre les voies 1 et 2. La tension résiduelle CC n'est pas inversée.
- Lorsque l'option TRACk est activée (ON), les limites de tension sur les 2 voies s'appliquent. Si les limites de tension sur une voie empêchent d'appliquer la configuration de l'autre voie, l'instrument génère une erreur de conflit des paramètres et le suivi entre les voies demeure désactivé (OFF).
- Lorsque l'option TRACk est activée (ON), les modifications d'une voie sont reflétées dans les deux voies. Lorsque l'option TRACk passe de l'état ON ou INV à OFF, les voies conservent leur configuration actuelle (fréquence, amplitude, etc.), mais vous pouvez modifier une voie sans affecter l'autre.
- Les limites de tension peuvent être réglées en mode suivi, mais il n'est pas possible de les définir en violation du signal actif.
- L'activation du suivi (ON) provoque la définition de **COMBine:FEED** sur NONE, ainsi que la désactivation de **FREQUency:COUPle**, **VOLTage:COUPle** et de **RATE:COUPle**.
- TRACk n'est pas autorisé si la source de modulation interne de la voie suivie est l'autre voie.
- La commande **OUTPut:SYNC:SOURce** s'applique à la voie suivie.



## Présentation du sous-système TRIGger

**REMARQUE** Le connecteur BNC de déclenchement interne de la face arrière est relié au châssis.

Configure le déclenchement d'une séquence, d'une liste, d'une rafale ou d'un balayage :

**TRIGger[1|2]** - déclenchement immédiat

**TRIGger[1|2]:COUNT** {<nombre>|MINimum|MAXimum|DEFAULT} - nombre de déclenchements

**TRIGger[1|2]:DELAY** {<secondes>|MINimum|MAXimum} - retard de déclenchement

**TRIGger[1|2]:LEVEL** {<niveau>|MINimum|MAXimum} - niveau de déclenchement

**TRIGger[1|2]:SLOPe** {POSitive|NEGative} - pente du signal de déclenchement sur le connecteur **Ext Trig** de la face arrière

**TRIGger[1|2]:SOURCE** {IMMediate|EXTernal|TIMer|BUS} - source (interne, externe, temporisée ou bus) du déclenchement acceptée par l'instrument

**TRIGger[1|2]:TIMer** {<secondes>|MINimum|MAXimum} - horloge utilisée lorsque **TRIGger[1|2]:SOURCE** est défini sur **TIMer**.

### **TRIGger[1|2]**

Force le déclenchement immédiat de la séquence, du balayage, de la liste ou de la rafale.

Paramètre	Renvoi type
(aucun)	(aucun)
Envoyer un déclenchement immédiat sur la voie 2 : TRIG	

- Peut être utilisée avec la source de déclenchement **IMMediate**, **EXTernal**, **TIMer** ou **BUS** (**TRIGger[1|2]:SOURCE**). Par exemple, vous pouvez utiliser la commande **TRIGger** pour envoyer un déclenchement immédiat en attendant un déclenchement externe.
- Est prioritaire. Pour un déclenchement général commandé par logiciel, utilisez la commande **\*TRG**.

**TRIGger[1|2]:COUNT {<nombre>MINimum|MAXimum|DEFault}**

**TRIGger[1|2]:COUNT? [{MINimum|MAXimum}]**

Configure le nombre de déclenchements

Paramètre	Renvoi type
1 à 1 000 000 ; 1 par défaut	10000
Définir le nombre de déclenchements de la voie 2 à la valeur 10 000 : TRIG2:COUN 10000	

- Peut être utilisée avec la source de déclenchement IMMEDIATE, EXTERNAL, TIMER ou BUS (TRIGger [1|2]:SOURCE).
- S'applique uniquement lorsque INITiate[1|2]:CONTinuous est désactivé (OFF).

**TRIGger[1|2]:DElay {<secondes>|MINimum|MAXimum}**

**TRIGger[1|2]:DElay? [{MINimum|MAXimum}]**

Définit le retard de déclenchement (temps entre l'application du déclenchement et l'événement déclenché).

Paramètre	Renvoi type
0 à 1 000 s, avec une résolution de 4 ns ; 0 par défaut	+1,0500000000000000E-01
Définir le retard de déclenchement de la voie 1 à 105 ms : TRIG:DEL 105e-3	

- Peut être utilisée avec la source de déclenchement IMMEDIATE, EXTERNAL, TIMER ou BUS (TRIGger [1|2]:SOURCE).

**TRIGger[1|2]:LEVel {<niveau>|MINimum|MAXimum}**

**TRIGger[1|2]:LEVel? [{MINimum|MAXimum}]**

Définit le niveau de déclenchement de sortie et le seuil de déclenchement d'entrée en volts. Le seuil de déclenchement correspond à la moitié du niveau de déclenchement.

Paramètre	Renvoi type
0,9 à 3,8 V	+3,3000000000000000E+00
Régler le niveau de déclenchement sur 2 V : TRIG:LEV 2	

**TRIGger[1|2]:SLOPe {POSitive|NEGative}**

**TRIGger[1|2]:SLOPe?**

Spécifie la polarité du signal de déclenchement sur le connecteur **Trig In** de la face arrière en mode de déclenchement externe.

<b>Paramètre</b>	<b>Renvoi type</b>
{ POSitive NEGative}, POS par défaut (front montant)	POS ou NEG
Définir la pente du signal de déclenchement sur le front descendant : TRIG:SLOP NEG	



## TRIGger[1|2]:SOURce {IMMEDIATE|EXTERNAL|TIMER|BUS}

### TRIGger[1|2]:SOURce?

Sélectionne la source de déclenchement d'une séquence, d'une liste, d'une rafale ou d'un balayage. L'instrument accepte un déclenchement immédiat, un déclenchement interne temporisé ou un déclenchement matériel sur le connecteur **Ext Trig** de la face arrière ou un déclenchement par logiciel (bus).

Paramètre	Renvoi type
{IMMEDIATE EXTERNAL TIMER BUS}, IMMEDIATE par défaut	IMM, EXT, TIM, BUS
Sélectionner la source de déclenchement externe (déclenchement chaque fois qu'une impulsion TTL vraie au niveau bas est reçue sur l'entrée de déclenchement de la face arrière) : TRIG:SOUR EXT	

En mode rafale déclenchée :

- L'instrument envoie un signal pendant un nombre spécifié de cycles (nombre de salves) lorsqu'un signal déclencheur est reçu. Après le nombre de cycles spécifié, l'instrument s'arrête et attend le déclenchement suivant.
- **IMMEDIATE (interne)** : l'instrument envoie la sortie en permanence lorsque le mode rafale est activé. La commande **BURSt:INTERNAL:PERIOD** détermine la vitesse de génération de la rafale.
- **EXTERNAL** : l'instrument accepte un déclenchement matériel sur le connecteur **Ext Trig** de la face arrière. L'instrument envoie une rafale du nombre spécifié de cycles chaque fois que le connecteur **Ext Trig** reçoit une transition de niveau avec la polarité appropriée (**TRIGger[1|2]:SLOPe**). Les signaux de déclenchement externe pendant une rafale sont ignorés.
- **BUS (logiciel)** : l'instrument démarre une rafale chaque fois qu'une commande de déclenchement sur le bus (**\*TRG**) est reçue. La touche **[Trigger]** de la face avant s'allume lorsque l'instrument attend un déclenchement sur le bus.
- **EXTERNAL ou BUS** : le nombre de rafales et la phase de la rafale restent effectifs, mais la période est ignorée.
- **TIMER** : les événements de déclenchement sont espacés par une temporisation ; le premier déclenchement a lieu dès l'exécution de la commande **INIT**.

En mode balayage de fréquence :

- **IMMEDIATE (interne)** : l'instrument envoie la sortie en permanence lorsque le balayage est activé. La période à laquelle le balayage est généré correspond au temps de balayage (**SWEp:TIME**) plus 1 ms.
- **EXTERNAL** : l'instrument accepte un déclenchement matériel sur le connecteur **Ext Trig** de la face arrière. L'instrument démarre un balayage chaque fois que le connecteur **Trig In** reçoit une impulsion TTL dont la polarité de front est correcte (**TRIGger[1|2]:SLOPe**). La période du déclenchement doit être au moins égale au temps de balayage (**SWEp:TIME**) plus 1 ms.
- **BUS (logiciel)** : l'instrument démarre un balayage chaque fois qu'une commande de déclenchement sur le bus (**\*TRG**) est reçue. La touche **[Trigger]** de la face avant s'allume lorsque l'instrument attend un déclenchement sur le bus.

- **APPLY** définit la source de déclenchement sur IMMEDIATE.
- Pour garantir la synchronisation avec la source BUS, envoyez la commande **\*WAI** (attente) de façon que l'instrument attende la fin de toutes les opérations en attente avant d'exécuter des commandes supplémentaires. Par exemple, la chaîne de caractères suivante garantit que le premier déclenchement est accepté et que l'opération est exécutée avant la reconnaissance du deuxième déclenchement.

TRIG:SOUR BUS;\*TRG;\*WAI;\*TRG;\*WAI

- Utilisez la commande **\*OPC?** ou **\*OPC** pour déterminer quand le balayage ou la rafale est terminé. La requête **\*OPC?** renvoie la valeur 1 dans la mémoire tampon de sortie lorsque le balayage ou la rafale est terminé. La commande **\*OPC** active le bit d'opération terminée (bit 0) dans le registre des événements standard lorsque le balayage ou la rafale est terminé.

**TRIGger[1|2]:TImer {<secondes>|MINimum|MAXimum}**

**TRIGger[1|2]:TImer? [{MINimum|MAXimum}]**

Règle l'horloge utilisée lorsque l'option **TRIGger[1|2]:SOURce** est **TImer**.

Paramètre	Renvoi type
1 µs à 8 000 s	+3,0000000000000000E-01
Régler le temporisateur de déclenchement sur 300 ms sur la voie 2 : TRIG2:TIM 0,3	

- En mode rafale déclenchée (**BURSt:MODE TRIG**), cette commande est prioritaire sur **BURSt:INTer-nal:PERiod**.



UNIT:ANGLE {DEGREE|RADIAN|SECOND|DEFAULT}  
UNIT:ANGLE?

Indique les unités d'angle qui sont affichées à l'écran et utilisées pour la spécification des angles. Les unités sélectionnées sont utilisées pour définir la phase initiale d'une rafale (**BURSt:PHASe**) et le décalage de la phase (**PHASe**). Les requêtes associées sont également affectées.

Paramètre	Renvoi type
{DEGREE RADIAN SECOND DEFAULT}, DEGREE par défaut	DEG, RAD ou SEC
Définir les unités d'angle en radians : UNIT:ANGL RAD	

- L'option SECONd est uniquement disponible sur la série 33600.
- Ce paramètre peut être ignoré en ajoutant des unités au paramètre numérique dans une commande. Par exemple, PHASE 90 DEG indique 90 degrés indépendamment de ce paramètre.
- L'écran de la face avant affiche toujours les angles en degrés indépendamment du paramètre UNIT:ANGLE.



UNIT:ARbitrary:ANGLE {DEGREE|RADIAN|SECOND|SAMPLE|DEFAULT}  
UNIT:ARbitrary:ANGLE?

Définit les unités de spécification de la phase du signal arbitraire. Le paramètre de phase dans les unités sélectionnées est affiché sur la face avant.

Paramètre	Renvoi type
{DEGREE RADIAN SECOND SAMPLE DEFAULT}, DEGREE par défaut	DEG, RAD, SEC ou SAMP
Définir les unités d'angle du signal arbitraire sur les échantillons : UNIT:ARB:ANGL SAMP	

- Les options SECond et SAMPlE sont uniquement disponibles sur les modèles série 33600.
- Vous pouvez également spécifier des unités en les ajoutant au paramètre numérique suivant :  
ARB:PHAS 10 DEG.

## Présentation du sous-système VOLTage

Le sous-système VOLTage configure les paramètres de la tension de sortie.

### Exemple

Vous trouverez ci-dessous une procédure type utilisant le sous-système VOLTage.

1. **Sélectionnez la forme, l'amplitude et la tension résiduelle du signal** : Utilisez la commande **APPLY** ou les commandes équivalentes **FUNCTION**, **FREQUENCY**, **VOLTage** et **VOLTage:OFFSET** pour sélectionner la fonction, la fréquence, l'amplitude et la tension résiduelle.
2. **Définissez les unités pour l'amplitude de sortie** :**VOLTage:UNIT**
3. **Définissez l'amplitude de sortie** :**VOLTage**
4. **Réglez la tension CC résiduelle** :**VOLTage:OFFSET**
5. **Définissez les niveaux de tension haut et bas** :**VOLTage:HIGH** et **VOLTage:LOW**
6. **Sélectionnez les limites de la tension de sortie pour protéger le dispositif testé (DUT)** :**VOLTage:LIMIT:HIGH**, **VOLTage:LIMIT:LOW** et **VOLTage:LIMIT:STATE**
7. **Sélectionnez la détection automatique pour toutes les fonctions de sortie** :**VOLTage:RANGE:AUTO**
8. **Réglez le couplage des tensions pour verrouiller l'amplitude et la tension résiduelle des voies de façon groupée (instruments 2 voies uniquement)** :**VOLTageLCOUPLE[:STATE]**

L'exemple suivant illustre la procédure ci-dessus :

```
SOURce1:FUNCTION SQU
SOURce1:FREQUENCY +1,0E+06
SOURce1:VOLTage +0,5
SOURce1:VOLTage:OFFSET +0,5
```

```
SOURce1:FUNction:SQUare:PERiod +1,0E-06
SOURce1:FUNction:PULSe:PERiod +1,0E-06
SOURce1:VOLTage:LIMit:LOW +0,0
SOURce1:VOLTage:LIMit:HIGH +1,0
SOURce1:VOLTage:LIMit:STATe 1
OUTP1 ON
SOURce2:FUNction SIN
SOURce2:FREQuency +1,0E+06
SOURce2:VOLTage +2,0
SOURce2:VOLTage:OFFSet +0,0
SOURce2:VOLTage:LIMit:LOW -1,0
SOURce2:VOLTage:LIMit:HIGH +1,0
SOURce2:VOLTage:LIMit:STATe 1
OUTP2 ON
```

[SOURce[1|2]:]VOLTage {<amplitude>|MINimum|MAXimum|DEFault}  
[SOURce[1|2]:]VOLTage? [{MINimum|MAXimum}]

Définit l'amplitude de sortie.

Paramètre	Renvoi type
1 mVpp à la <b>valeur maximale autorisée pour le signal et le modèle</b> , 100 mVpp par défaut	+5,0000000000000E+00
Définir l'amplitude de sortie à 5 Vpp : VOLT 5 Vpp	

- Le rapport entre la tension résiduelle et l'amplitude de sortie est illustré ci-dessous.  $V_{max}$  est la tension de crête maximale compte tenu de l'impédance de sortie déclarée (soit 50  $\Omega$  pour une charge de 50  $\Omega$  ou 10 V pour une charge haute impédance).

$$|V_{offset}| < V_{max} - V_{pp}/2$$

Si la tension résiduelle saisie est incorrecte, l'instrument la règle au niveau maximal autorisé avec l'amplitude spécifiée. Sur l'interface distante, l'erreur « Data out of range » est également générée.

- Différences entre l'utilisation de l'interface distante et de la face avant :**
  - Interface distante :** La définition de l'amplitude sur l'interface distante peut modifier la tension résiduelle pour obtenir l'amplitude souhaitée. L'instrument génère une erreur « Data out of range » ou « Settings conflict ». Si la tension résiduelle n'est pas correcte, l'instrument la règle au niveau maximal autorisé avec l'amplitude spécifiée.
  - Face avant :** La définition de l'amplitude sur la face avant ne modifie pas le réglage de la tension résiduelle. Si l'amplitude spécifiée n'est pas correcte, l'instrument conserve l'amplitude maximale autorisée avec la tension résiduelle actuelle et génère l'erreur « Data out of range ».
- Limites imposées par l'impédance de sortie :** Si l'amplitude est de 10 Vpp et si vous modifiez la terminaison de sortie de 50  $\Omega$  à « haute impédance » (OUTPut[1|2]:LOAD INF), l'amplitude double pour atteindre 20 Vpp. Toute modification de la « haute impédance » à 50  $\Omega$  réduit de moitié l'amplitude affichée. L'impédance de sortie n'affecte pas la tension de sortie réelle. Elle modifie uniquement les valeurs affichées et récupérées de l'interface distante. La tension de sortie réelle varie en fonction de la charge connectée.
- Limites imposées par le couplage des sorties :**
  - Différences entre l'utilisation de l'interface distante et de la face avant :** Si 2 voies sont couplées, les limitations sur les amplitudes de ces 2 voies sont vérifiées avant de modifier une amplitude. Si une variation de l'amplitude de sortie est supérieure à une limite pour une voie, ou aux spécifications de sortie de l'instrument pour les deux voies :
    - Interface distante :** L'instrument ajuste d'abord la tension résiduelle puis, si nécessaire, l'amplitude de cette voie pour respecter les conditions limites ou les spécifications de tension. L'instrument génère une erreur « Data out of range » ou « Settings conflict ».



- **Face avant** : L'instrument adopte l'amplitude maximale avec la tension résiduelle active. L'erreur « Data out of range » est générée.
- *Spécification des unités de tension* : Vous pouvez spécifier l'amplitude de sortie en Vpp, Veff ou dBm dans la commande `VOLTage VOLT 3.0 VRMS`.

Utilisez la commande `VOLTage:UNIT` pour spécifier les unités de sortie de toutes les commandes suivantes.

Vous ne pouvez pas spécifier l'amplitude de sortie en dBm si la terminaison de sortie est réglée sur une impédance élevée. Les unités sont automatiquement converties en Volts crête/crête (Vpp).

- **Limites imposées par la sélection de l'unité** : Les limites d'amplitude sont parfois déterminées par l'unité de sortie sélectionnée. Cela peut se produire lorsque l'unité est Veff ou dBm en raison des différences entre les facteurs de crête de diverses fonctions. Par exemple, si vous modifiez un signal carré 5 Vrms (dans une charge de 50 Ω) en signal sinusoïdal, l'instrument ajuste l'amplitude à 3,536 Veff (limite maximale Vrms pour un signal sinusoïdal). L'interface distante génère également une erreur de conflit des paramètres.
- **Limitations concernant les signaux arbitraires** : Pour les signaux arbitraires, l'amplitude est limitée si les points du signal ne couvrent pas toute la plage du convertisseur N/A de sortie. Par exemple, le signal intégré « Sinc » n'utilise pas la plage totale de valeurs ; son amplitude est donc limitée à 6,087 Vpp (dans une charge de 50 Ω).
- **La modification de l'amplitude peut interrompre brièvement la sortie à certaines tensions en raison de la commutation de l'atténuateur de sortie.** Néanmoins, l'amplitude est contrôlée de façon que la tension de sortie ne soit jamais supérieure au réglage actuel lorsque la commutation a lieu. Pour éviter cette interruption, désactivez la détection automatique de la tension à l'aide de la commande `VOLTage:RANGe:AUTO OFF`. La commande `APPLY` active automatiquement la détection automatique.
- Vous pouvez également régler l'amplitude (avec une tension résiduelle associée) en spécifiant un niveau haut (`VOLTage:HIGH`) et un niveau bas (`VOLTage:LOW`). Par exemple, si vous réglez le niveau haut sur +2 V et le niveau bas sur -3 V, l'amplitude résultante est de 5 Vpp avec une tension résiduelle de -500 mV.
- Pour envoyer une tension continue, sélectionnez la fonction tension continue (CC - **FUNCTION DC**) et réglez ensuite la tension résiduelle (`VOLTage:OFFSet`). Les valeurs acceptées sont comprises entre ±5 Vcc dans une charge de 50 Ω ou ±10 Vcc dans un circuit ouvert. Lorsque l'instrument est en mode CC, le réglage de l'amplitude ne produit aucun effet.

[SOURce[1|2]:]VOLTage:COUPle[:STATe] {ON|1|OFF|0}  
[SOURce[1|2]:]VOLTage:COUPle[:STATe]?

Active/désactive sur un instrument 2 voies la conservation de l'amplitude, de la tension résiduelle, de la plage, de la charge et de l'unité. Cette commande s'applique aux 2 voies ; le mot clé SOURce est ignoré.

Paramètre	Renvoi type
{ON 1 OFF 0}, OFF par défaut	0 (OFF) ou 1 (ON)
Activer le couplage des tensions : VOLT:COUP ON	

[SOURce[1|2]:]VOLTage:HIGH {< tension>|MINimum|MAXimum|DEFault}  
[SOURce[1|2]:]VOLTage:HIGH? [{MINimum|MAXimum}]

[SOURce[1|2]:]VOLTage:LOW {< tension>|MINimum|MAXimum|DEFault}  
[SOURce[1|2]:]VOLTage:LOW? [{MINimum|MAXimum}]

Règle les niveaux haut et bas de tension du signal.

Paramètre	Renvoi type
±5 Vcc dans une charge de 50 Ω dès lors que la valeur HIGH est supérieure de 1 mV à la valeur LOW. Par défaut : HIGH +50 mV, LOW -50 mV.	+4,000000000000000E+00
Régler le niveau de tension haut sur 4 V : VOLT:HIGH 4	

- *Limites imposées par l'amplitude* : Vous pouvez configurer des niveaux de tension positifs ou négatifs avec les limitations ci-dessous. Vpp est l'amplitude maximale crête à crête de l'impédance de sortie sélectionnée (10 Vpp dans une charge de 50 Ω ou 20 Vpp dans un circuit ouvert).

$$V_{\text{high}} - V_{\text{low}} \leq V_{\text{pp}} (\text{max}) \text{ et } V_{\text{high}}, V_{\text{low}} \leq V_{\text{pp}} (\text{max})/2$$

- *Différences entre l'utilisation de l'interface distante et de la face avant* :
  - **Interface distante** : La configuration du niveau haut ou bas à partir de l'interface distante peut modifier le niveau haut ou bas pour obtenir le réglage souhaité. Dans ce cas, l'erreur « Data out of range » ou « Settings conflict » s'affiche. Si le niveau haut est défini sous le niveau bas, l'instrument configure le niveau bas 1 mV sous le niveau haut. Si le niveau bas est configuré sous la limite inférieure (LOW) ou des spécifications de sortie de l'instrument, le niveau bas est réglé sur la limite inférieure (LOW) ou les spécifications de sortie de l'instrument et le niveau haut est défini à 1 mV au-dessus du niveau bas. Un ensemble de règles similaires s'applique si le niveau bas est configuré incorrectement.
  - **Face avant** : La configuration du niveau haut ou bas sur la face avant peut rogner ce niveau pour obtenir le niveau souhaité ; l'erreur « Data out of range » est générée. Il n'est pas possible de configurer un niveau haut inférieur au niveau bas sur la face avant.
- La configuration des niveaux haut et bas entraîne également celle de l'amplitude et de la tension résiduelle du signal. Par exemple, si vous réglez le niveau haut sur +2 V et le niveau bas sur -3 V, l'amplitude résultante est de 5 Vpp avec une tension résiduelle de -500 mV.
- *Limites imposées par l'impédance de sortie* : Si l'amplitude est de 10 Vpp et si vous modifiez la terminaison de sortie de 50 Ω à « haute impédance » (OUTPut[1|2]:LOAD INF), l'amplitude double pour atteindre 20 Vpp. Toute modification de la « haute impédance » à 50 Ω réduit de moitié l'amplitude affichée. L'impédance de sortie n'affecte pas la tension de sortie réelle. Elle modifie uniquement les valeurs affichées et récupérées de l'interface distante. La tension de sortie réelle varie en fonction de la charge connectée.

- *Limites imposées par VOLTage:LIMit:STATE* : Si les limites de tension sont activées, les réglages de tension sont vérifiés par rapport aux limites spécifiées (**VOLTage:LIMit:HIGH**, **VOLTage:LIMit:LOW**) avant de modifier un niveau. Si le niveau de sortie varie au-delà du réglage LIMIT, il est fixé au maximum (ou minimum) autorisé qui ne dépasse pas cette valeur LIMit ; l'erreur « Settings conflict » est générée.
- *Limites imposées par le couplage des sorties* : Si 2 voies sont couplées, les limites sont vérifiées sur ces 2 voies avant de modifier un niveau. Si le niveau varie au-delà du réglage LIMIT ou des spécifications de sortie de l'instrument, il est fixé au maximum (ou minimum) autorisé qui ne dépasse pas cette valeur LIMit ; l'erreur « Settings conflict » est générée.
- Pour inverser un signal par rapport à la tension résiduelle, utilisez la commande **OUTPut[1|2]:POLarity**.

[SOURce[1|2]:]VOLTage:LIMit:HIGH {< tension>|MINimum|MAXimum|DEFault}  
[SOURce[1|2]:]VOLTage:LIMit:HIGH? [{MINimum|MAXimum}]

[SOURce[1|2]:]VOLTage:LIMit:LOW {< tension>|MINimum|MAXimum|DEFault}  
[SOURce[1|2]:]VOLTage:LIMit:LOW? [{MINimum|MAXimum}]?

Règle les limites haute et basse de la tension de sortie.

Paramètre	Renvoi type
±5 Vcc dans une charge de 50 Ω dès lors que la valeur HIGH est supérieure de 1 mV à la valeur LOW. Par défaut : HIGH +50 mV, LOW - 50 mV.	+5,00000000000000E+00
Régler la limite haute de sortie de la voie 1 sur 5 V : VOLT:LIMIT:HIGH 5,0 VOLT:LIMIT:STATE ON	

- Pour que les limites de tension prennent effet, **VOLTage:LIMit:STATe** doit être activé (ON). Dans ce cas et si la limite maximale est inférieure à la valeur haute du signal ou si la limite minimale est supérieure à la valeur basse du signal, la limite correspondante est rognée à la valeur haute ou basse du signal. L'instrument génère une erreur « Data out of range » ou « Settings conflict ».
- La limite supérieure règle la tension de sortie maximale autorisée en incluant la tension CC résiduelle et l'amplitude en crête. Elle est réglée par rapport au paramètre **OUTPUT[1|2]:LOAD** actuel. Si l'impédance de la charge spécifiée n'est pas présente sur la sortie de l'instrument, la limite sur la sortie ne représentera peut-être pas les tensions réelles sur le connecteur de sortie. Par exemple, si l'impédance de sortie est configurée sur 50 Ω, mais si la charge réelle est en haute impédance, la tension réelle en crête peut être atteindre une valeur deux fois supérieure à la tension limite spécifiée.
- *Spécification des unités de tension* : Vous pouvez spécifier la tension de sortie limite uniquement en volts.
- Lorsque **VOLTage:COUPle[:STATe]** et **VOLTage:LIMit:STATe** sont activés (ON), les limites de tension sur les 2 voies affectent l'amplitude maximale et la tension résiduelle sur les 2 voies. La combinaison la plus restrictive des limites haute et basse d'une voie est utilisée.

[SOURce[1|2]:]VOLTage:LIMit:STATe {ON|1|OFF|0}  
[SOURce[1|2]:]VOLTage:LIMit:STATe?

Active/désactive les limites d'amplitude de la tension de sortie.

Paramètre	Renvoi type
{ON 1 OFF 0}, OFF par défaut	0 (OFF) ou 1 (ON)
Régler et activer des limites de sortie $\pm 2,5$ V sur la voie 1 : VOLT:LIM:HIGH 2,5 VOLT:LIM:LOW -2,5 VOLT:LIM:STAT ON	

- Lorsque cette commande est activée (ON), si les réglages actuels de l'amplitude et de la tension résiduelle sont supérieurs aux limites, celles-ci sont désactivées. L'instrument génère l'erreur « Settings conflict ».
- Lorsque **VOLTage:COUPle[:]STATe]** et **VOLTage:LIMit:STATe** sont activés (ON), les limites de tension sur les 2 voies affectent l'amplitude maximale et la tension résiduelle sur les 2 voies. La combinaison la plus restrictive des limites haute et basse d'une voie est utilisée.
- Les limites sont réglées par rapport au paramètre **OUTPut[1|2]:LOAD** actuel. Si l'impédance de la charge spécifiée n'est pas présente sur la sortie de l'instrument, la limite sur la sortie ne représentera peut-être pas les tensions réelles sur le connecteur de sortie. Par exemple, si l'impédance de sortie est configurée sur 50  $\Omega$ , mais si la charge réelle est en haute impédance, la tension réelle en crête peut être atteindre une valeur deux fois supérieure à la tension limite spécifiée.

[SOURce[1|2]:]VOLTage:OFFSet {< tension résiduelle >|MINimum|MAXimum|DEFAULT}  
[SOURce[1|2]:]VOLTage:OFFSet? [{MINimum|MAXimum}]

Règle la tension CC résiduelle.

Paramètre	Renvoi type
± 5 Vcc dans une charge de 50 Ω, 0 par défaut	+1,0000000000000E-01
Régler la tension résiduelle sur 100 mV : VOLT:OFFS 100 mV	

- Le rapport entre la tension résiduelle et l'amplitude de sortie est illustré ci-dessous.

$$|V_{offset}| < V_{max} - V_{pp}/2$$

- Différences entre l'utilisation de l'interface distante et de la face avant :
  - **Interface distante** : Le réglage de la tension résiduelle sur l'interface distante peut provoquer une modification de l'amplitude pour obtenir la tension résiduelle souhaitée. L'instrument génère une erreur « Data out of range » ou « Settings conflict ».
  - **Face avant** : Le réglage de la tension résiduelle sur la face avant n'entraîne pas la modification de l'amplitude pour obtenir la tension résiduelle désirée. Si la tension résiduelle spécifiée n'est pas correcte, l'instrument conserve la tension résiduelle maximale autorisée avec l'amplitude actuelle et génère l'erreur « Data out of range ».
- Limites imposées par l'impédance de sortie : La plage de la tension résiduelle dépend de l'impédance de sortie. Par exemple, si vous configurez une tension résiduelle de 100 mVcc et modifiez ensuite l'impédance de sortie de 50 Ω à « haute impédance », la tension résiduelle affichée sur la face avant est multipliée par deux et passe à 200 mVcc (aucune erreur générée). Si vous passez de « haute impédance » à 50 Ω, la tension résiduelle affichée est divisée par deux. Pour plus d'informations, reportez-vous à la commande **OUTPut[1|2]:LOAD**. La modification de l'impédance de sortie n'a aucune répercussion sur la tension aux bornes de sortie de l'instrument. Seules les valeurs affichées sur la face avant et les valeurs demandées sur l'interface distante sont modifiées. La tension sur la sortie de l'instrument dépend de la charge connectée à l'instrument. Pour plus d'informations, reportez-vous à la commande **OUTPut[1|2]:LOAD**.
- *Limites imposées par le couplage des sorties* : Si deux voies sont couplées, les limitations de la tension résiduelle sont vérifiées sur ces voies avant qu'une modification ne soit apportée à la tension résiduelle. Si une variation de la tension résiduelle est supérieure à une limite ou aux spécifications de sortie de l'instrument sur l'une des voies :
  - *Interface distante* : L'instrument ajuste d'abord l'amplitude puis, si nécessaire, la tension résiduelle de cette voie pour respecter les limites ou les spécifications de tension. L'instrument génère une erreur « Data out of range » ou « Settings conflict ».
  - *Face avant* : La tension résiduelle est conservée à la valeur maximale autorisée qui ne doit pas dépasser le réglage LIMit ; l'erreur « Data out of range » est générée.
- Limitations concernant les signaux arbitraires : Pour les signaux arbitraires, l'amplitude est limitée si les points du signal ne couvrent pas toute la plage du convertisseur N/A de sortie. Par exemple, le signal

intégré « Sinc » n'utilise pas la plage totale de valeurs ; son amplitude est donc limitée à 6,087 Vpp (dans une charge de 50 Ω).

- La modification de l'amplitude peut interrompre brièvement la sortie à certaines tensions en raison de la commutation de l'atténuateur de sortie. Néanmoins, l'amplitude est contrôlée de façon que la tension de sortie ne soit jamais supérieure au réglage actuel lorsque la commutation a lieu. Pour éviter cette interruption, désactivez la détection automatique de la tension à l'aide de la commande **VOLTage:RANGe:AUTO OFF**. La commande **APPLy** active automatiquement la détection automatique.
- La configuration des niveaux haut et bas entraîne également celle de l'amplitude et de la tension résiduelle du signal. Par exemple, si vous réglez le niveau haut sur +2 V et le niveau bas sur -3 V, l'amplitude résultante est de 5 Vpp avec une tension résiduelle de -500 mV.
- Pour envoyer une tension continue, sélectionnez la fonction tension continue (CC - **FUNction DC**) et réglez ensuite la tension résiduelle (**VOLTage:OFFSet**). Les valeurs acceptées sont comprises entre ±5 Vcc dans une charge de 50 Ω ou ±10 Vcc dans un circuit ouvert. Lorsque l'instrument est en mode CC, le réglage de l'amplitude ne produit aucun effet.

**[SOURce[1|2]:]VOLTage:RANGe:AUTO {OFF|0|ON|1|ONCE}**

**[SOURce[1|2]:]VOLTage:RANGe:AUTO?**

Active/désactive la détection automatique de la tension pour toutes les fonctions. ONCE effectue une détection immédiate, puis désactive la détection automatique.

Paramètre	Renvoi type
{OFF 0 ON 1 ONCE}, ON par défaut	0 (OFF) ou 1 (ON)
Désactiver la détection automatique de la tension : VOLT:RANG:AUTO 0	

- En mode par défaut, la détection automatique est activée et l'instrument sélectionne automatiquement les meilleurs réglages du générateur et de l'atténuateur du signal de sortie.
- Lorsque la détection automatique est désactivée, l'instrument utilise les réglages actifs du gain et de l'atténuateur.
- La commande **APPLy** remplace le réglage de la détection automatique et active automatiquement la détection automatique.
- La désactivation de la détection automatique entraîne la suppression des interruptions momentanées dues à la commutation de l'atténuateur pendant la modification de l'amplitude. Cependant, la précision et la résolution de l'amplitude et de la tension résiduelle (et la fidélité du signal) peuvent être affectées si l'amplitude diminue au-dessous de la modification attendue de plage de réglage.
- Si la commande **VOLTage:COUPle[:]STATe** est activée, la modification de ce réglage sur une voie est répercutée sur les 2 voies.



[SOURce[1|2]:]VOLTage:UNIT {VPP|VRMS|DBM}  
[SOURce[1|2]:]VOLTage:UNIT?

Sélectionne les unités de l'amplitude de sortie.

Paramètre	Renvoi type
{VPP VRMS DBM}, VPP par défaut	VPP, VRMS ou DBM
Définir l'unité de l'amplitude de sortie en Veff : VOLT:UNIT VRMS	

- N'a pas d'influence sur la tension résiduelle (VOLTage:OFFSet), le niveau haut (VOLTage:HIGH) ou le niveau bas (VOLTage:LOW). L'unité est le volt pour toutes ces valeurs.
- L'instrument utilise la sélection en cours de l'unité pour les opérations sur la face avant et l'interface distante. Par exemple, si vous sélectionnez « VRMS » sur l'interface distante (VOLTage:UNIT VRMS), l'unité affichée sur la face avant est « VRMS ».
- Cette commande s'applique aux résultats de la requête VOLTage?.
- Il n'est pas possible de configurer l'unité de sortie de l'amplitude en dBm si l'impédance de sortie est réglée sur « haute impédance ». Les unités sont automatiquement converties en Volts crête/crête (Vpp).
- Les suites de signaux arbitraires n'acceptent pas les unités Veff ou dBm.
- À moins de spécifier l'unité dans la commande VOLTage ou l'une des commandes APPLY, la commande VOLTage:UNIT prévaut. Par exemple, si vous sélectionnez VOLTage:UNIT VRMS et ne précisez pas d'unité avec une commande APPLY, l'« amplitude » de la commande APPLY est exprimée en « Veff ».

## Exemples de programmation

Ces exemples de programmation vous permettent de vous familiariser rapidement avec les tâches courantes.

[Configuration d'un signal sinusoïdal](#)

[Configuration d'un signal carré](#)

[Configuration d'une rampe](#)

[Configuration d'un train d'impulsions](#)

[Création d'une liste de fréquences](#)

[Configuration d'un signal arbitraire](#)

### Configurer un signal sinusoïdal

Cette section décrit la configuration d'un signal sinusoïdal.

## Description

Un signal sinusoïdal possède une amplitude, une tension résiduelle et une phase qui varient en fonction de l'impulsion de synchronisation. (missing or bad snippet)

## Exemple

Vous pouvez configurer le signal suivant avec la série de commandes SCPI, dans lesquelles les valeurs haut et bas peuvent être utilisées à la place de **SOUR:VOLT** et **SOUR:VOLT:OFFS**.

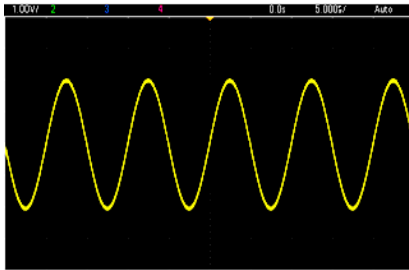

Les commandes suivantes produisent le signal sinusoïdal représenté ci-dessus.

```
FUNCTION SIN
FREQUENCY +1,0E+05
VOLTage:HIGH +2,0
VOLTage:LOW +0,0
OUTPUT ON
PHASe +90,0
```

## Remarques

- Même si la période peut être réglée sur la face avant, aucune commande **SOUR:FUNC:SIN:PER** ou **SOUR:PER** ne peut être utilisée en plus de la commande **SOUR:FREQ**.

## Configurer un signal carré

### Description

Un signal carré possède une amplitude, une tension résiduelle et une phase qui varient en fonction de l'impulsion de synchronisation. Il possède également un rapport cyclique et une période. (missing or bad snippet)

### Exemple

Vous pouvez configurer le signal suivant avec la série de commandes SCPI, dans lesquelles les valeurs haut et bas peuvent être utilisées à la place de **SOUR:VOLT** et **SOUR:VOLT:OFFS**.

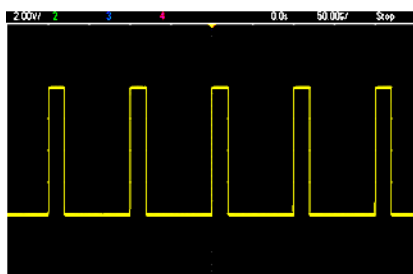

Les commandes suivantes produisent le signal carré représenté ci-dessus.

```

FUNC SQU
FUNC:SQU:DCYC +20,0
FREQ +1,0E+04
VOLT:HIGH +4,0
VOLT:LOW +0,0
OUTP 1

```

### Remarques

- Dans le cas d'un signal carré, une modification de la commande **SOUR:FREQ** se répercute sur la commande **SOUR:FUNC:SQU:PER**. Par exemple, la commande **SOUR:FREQ +2,0E+03** est équivalente à **SOUR:FUNC:SQU:PER +5,0E-04**.

## Configurer une rampe

### Description

Une rampe possède une amplitude, une tension résiduelle et une phase qui varient en fonction de l'impulsion de synchronisation. Elle comporte également une symétrie pour créer des signaux triangulaires et d'autres signaux similaires. (missing or bad snippet)

### Exemple

Vous pouvez configurer le signal suivant avec la série de commandes SCPI, dans lesquelles les valeurs haut et bas peuvent être utilisées à la place de **SOUR:VOLT** et **SOUR:VOLT:OFFS**.

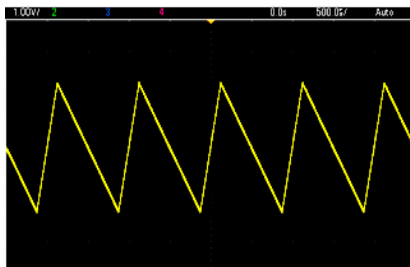

Les commandes suivantes produisent la rampe représentée ci-dessus.

```

FUNCTION RAMP
FUNCTION:RAMP:SYMMetry 25
FREQ +1,0E+03
VOLTage +2,0

```

```
VOLTage:OFFSet +1,0  
OUTP 1
```

## Remarques

- La fréquence d'une rampe est limitée à 200 kHz.
- Même si la période peut être réglée sur la face avant de l'instrument, aucune commande SOUR:FUNC:RAMP:PER ou SOUR:PER ne peut être utilisée en plus de la commande **SOUR:FREQ**.

## Configurer un train d'impulsions

### Description

Un train d'impulsions possède une amplitude, une tension résiduelle et une phase qui varient en fonction de l'impulsion de synchronisation. Il comporte également une pente de front, une période et un rapport cyclique (ou une largeur d'impulsion, selon la configuration **FUNC:PULSe:HOLD**). (missing or bad snippet)

### Exemple

Vous pouvez configurer le signal suivant avec la série de commandes SCPI, dans lesquelles les valeurs haut et bas peuvent être utilisées à la place de **SOUR:VOLT** et **SOUR:VOLT:OFFS**.

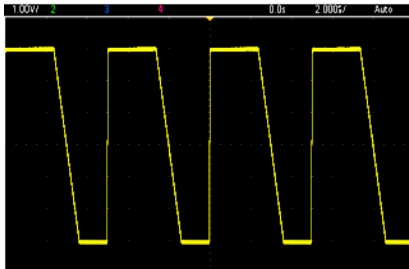

Les commandes suivantes produisent le train d'impulsions représenté ci-dessus.

```
FUNC PULS  
FUNC:PULS:TRAN:LEAD 4E-8  
FUNC:PULS:TRAN:TRA 1E-6  
FUNC:PULS:WIDT 3E-6  
FREQ 2E5  
VOLT 3  
OUTP ON
```

## Remarques

- Vous pouvez utiliser la commande **FUNC:PULS:PER** à la place de **FREQ**. Ces commandes sont interdépendantes ; la modification d'une commande se reflète dans une autre.

- L'impulsion peut être spécifiée par sa largeur ou son rapport cyclique, également interdépendantes. Utilisez la commande **FUNCTION:PULSE:HOLD DCYC** pour indiquer que le rapport cyclique demeure constant lorsque la fréquence ou la période change. Utilisez la commande **FUNCTION:PULSE:HOLD WIDTH** pour indiquer que la largeur d'impulsion demeure constante lorsque la fréquence ou la période change.

## Créer une liste de fréquences

### Description

Les commandes **LIST** permettent de définir la fréquence de sortie de l'instrument en fonction des entrées d'une liste de 128 fréquences maximum. Cette dernière permet d'alterner rapidement entre les fréquences. Les fréquences à utiliser sont saisies via la commande **LIST:FREQUENCY** ou lues dans un fichier à l'aide de la commande **MMEMORY:LOAD:LIST[1|2]**.

### Exemples

Le code suivant illustre la méthode **LIST:FREQUENCY** :

```
FUNCTION SQU
TRIGGER:SOURCE IMMEDIATE
FREQUENCY:MODE LIST
LIST:DWELL +5,0E-03
LIST:FREQUENCY +1.0E+03,+3.0E+03,+7.0E+03
VOLTAGE +1,0
OUTPUT 1
```

Les résultats de ce code sont présentés ci-dessous.

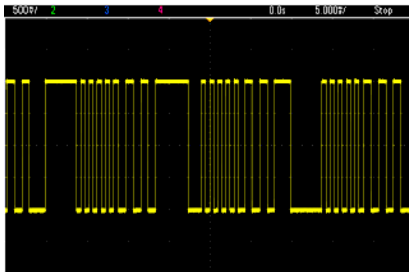

## Configurer un signal arbitraire

Cette section décrit la configuration d'un signal arbitraire.

### Description

Un signal arbitraire créé par l'utilisateur comporte une amplitude, une tension résiduelle, une fréquence d'échantillonnage et un type de filtre. Vous pouvez configurer ces derniers lorsque le fichier du signal (extension **.arb** ou **.barb**) est chargé dans la mémoire des signaux. Le début d'un signal arbitraire type est représenté ci-dessous. Notez que l'amplitude et la tension résiduelle sont représentées par des tensions haute et basse :

```
File Format:1.10
Checksum:0
Channel Count:1
Sample Rate:20000,000000
High Level:2,000000
Low Level:0,000000
Marker Point:50
Data Type:"short"
Filter:"off"
Data Points:100
Data:
23259
23114
```

Les lignes **23259** et **23114** qui suivent la ligne **Data:** sont des codes ASCII de convertisseur N/A qui représentent les deux premières valeurs du signal. Si ces codes ne sont pas compris entre -32 767 et + 32 767, l'amplitude de la sortie est asymétrique.

Jusqu'à la version 1.12 comprise du microprogramme, l'instrument ne mettait pas à jour les métadonnées du signal (fréquence d'échantillonnage, plage de tension et filtre) lors du passage d'un signal arbitraire à un autre. Le nouveau signal arbitraire adoptait les métadonnées du signal déjà en mémoire. Par conséquent, un signal arbitraire conçu pour être lu à une plage de tension, une fréquence d'échantillonnage et un filtre donnés (spécifiés dans les métadonnées du signal) était remplacé par un autre ensemble de métadonnées. Après la version 1.12 du microprogramme, les signaux arbitraires chargent toutes les métadonnées présentes dans le fichier de signal arbitraire afin qu'ils soient lus comme auparavant.

Les signaux intégrés apportent peu ou pas de modifications lorsqu'ils sont chargés dans la mémoire des signaux. Ils sont lus d'après la configuration actuelle de l'instrument. À titre d'exemple, reportez-vous au début du fichier Haversine.arb illustré ci-dessous.

```
Copyright: Keysight Technologies, 2010
File Format:1.0
Channel Count:1
Data Points:40
Data:
0
202
802
```

Du fait de l'absence de métadonnées, les paramètres actuels de plage de tension, de fréquence d'échantillonnage et de filtre sont utilisés.

## Exemple

Le code suivant charge et modifie un signal arbitraire intégré.

```
FUNCTION ARB
VOLTage +3
VOLTage:OFFSet +1
FUNC:ARB:SRAT 1E5
```

```
FUNction:ARbitrary "INT:\BUILTIN\EXP_RISE.ARB"  
OUTPut 1
```

Le signal résultant de ces commandes est illustré ci-dessous.

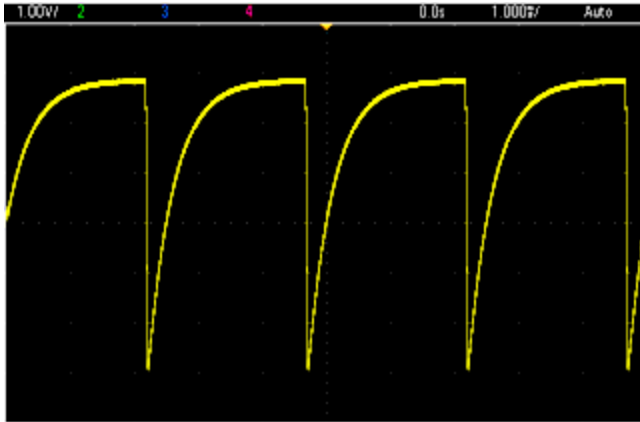

Aide-mémoire des commandes Keysight série Trueform

Reportez-vous à la section [Conventions syntaxiques](#) relative aux commandes SCPI.

## Commandes APPLy

[SOURce[1|2]:]APPLy?

[SOURce[1|2]:]APPLy:ARBitrary [{< fréquence\_échantillonnage >|MIN|MAX|DEF} [, {< amplitude >|MIN|MAX|DEF} [, {< tension résiduelle >|MIN|MAX|DEF}]]]

[SOURce[1|2]:]APPLy:DC [{< fréquence >|MIN|MAX|DEF} [, {< amplitude >|MIN|MAX|DEF} [, {< tension résiduelle >|MIN|MAX|DEF}]]]

[SOURce[1|2]:]APPLy:NOISe [{< fréquence >|MIN|MAX|DEF} [, {< amplitude >|MIN|MAX|DEF} [, {< tension résiduelle >|MIN|MAX|DEF}]]]

[SOURce[1|2]:]APPLy:PRBS [{< fréquence >|MIN|MAX|DEF} [, {< amplitude >|MIN|MAX|DEF} [, {< tension résiduelle >|MIN|MAX|DEF}]]]

[SOURce[1|2]:]APPLy:PULSe [{< fréquence >|MIN|MAX|DEF} [, {< amplitude >|MIN|MAX|DEF} [, {< tension résiduelle >|MIN|MAX|DEF}]]]

[SOURce[1|2]:]APPLy:RAMP [{< fréquence >|MIN|MAX|DEF} [, {< amplitude >|MIN|MAX|DEF} [, {< tension résiduelle >|MIN|MAX|DEF}]]]

[SOURce[1|2]:]APPLy:SINusoid [{< fréquence >|MIN|MAX|DEF} [, {< amplitude >|MIN|MAX|DEF} [, {< tension résiduelle >|MIN|MAX|DEF}]]]

[SOURce[1|2]:]APPLy:SQUare [{< fréquence >|MIN|MAX|DEF} [, {< amplitude >|MIN|MAX|DEF} [, {< tension résiduelle >|MIN|MAX|DEF}]]]

[SOURce[1|2]:]APPLy:TRIangle [{< fréquence >|MIN|MAX|DEF} [, {< amplitude >|MIN|MAX|DEF} [, {< tension résiduelle >|MIN|MAX|DEF}]]]

## Commandes DATA

[SOURce[1|2]:]DATA:ARBitrary2:FORMat {AABB|ABAB}

[SOURce[1|2]:]DATA:ARBitrary[1|2] < nom\_signal\_arb >, {< bloc\_binaire >|< valeur >, < valeur >, . . . }

[SOURce[1|2]:]DATA:ARBitrary[1|2]:DAC < nom\_signal\_arb >, {< bloc\_binaire >|< valeur >, < valeur >, . . . }

[SOURce[1|2]:]DATA:ATTRibute:AVERage? [< nom\_signal\_arb >]

[SOURce[1|2]:]DATA:ATTRibute:CFACTOR? [< nom\_signal\_arb >]

[SOURce[1|2]:]DATA:ATTRibute:POINts? [< nom\_signal\_arb >]

[SOURce[1|2]:]DATA:ATTRibute:PTPeak? [< nom\_signal\_arb >]

[SOURce[1|2]:]DATA:SEQuence < descripteur\_bloc >

[SOURce[1|2]:]DATA:VOLatile:CATalog?

[SOURce[1|2]:]DATA:VOLatile:CLEar

[SOURce[1|2]:]DATA:VOLatile:FREE?



## Commandes de configuration de la sortie

[SOURce[1|2]:]FUNction <fonction>  
[SOURce[1|2]:]FUNction?

### CONTRÔLE DE FRÉQUENCE

[SOURce[1|2]:]FREQuency {<fréquence>|MINimum|MAXimum|DEFault}  
[SOURce[1|2]:]FREQuency? [{MINimum|MAXimum}]

[SOURce[1|2]:]FREQuency:CENTer {<fréquence>|MINimum|MAXimum|DEFault}  
[SOURce[1|2]:]FREQuency:CENTer? [{MINimum|MAXimum}]

[SOURce[1|2]:]FREQuency:COUple:MODE {OFFSet|RATio}  
[SOURce[1|2]:]FREQuency:COUple:MODE?

[SOURce[1|2]:]FREQuency:COUple:OFFSet {<fréquence>|MINimum|MAXimum|DEFault}  
[SOURce[1|2]:]FREQuency:COUple:OFFSet?

[SOURce[1|2]:]FREQuency:COUple:RATio <rapport>  
[SOURce[1|2]:]FREQuency:COUple:RATio?

[SOURce[1|2]:]FREQuency:COUple[:STATe] {ON|1|OFF|0}  
[SOURce[1|2]:]FREQuency:COUple[:STATe]?

[SOURce[1|2]:]FREQuency:MODE {CW|LIST|SWEep|FIXed}  
[SOURce[1|2]:]FREQuency:MODE?

[SOURce[1|2]:]FREQuency:SPAN {<fréquence>|MINimum|MAXimum|DEFault}  
[SOURce[1|2]:]FREQuency:SPAN? [{MINimum|MAXimum}]

[SOURce[1|2]:]FREQuency:STARt {<fréquence>|MINimum|MAXimum|DEFault}  
[SOURce[1|2]:]FREQuency:STARt? [{MINimum|MAXimum}]

[SOURce[1|2]:]FREQuency:STOP {<fréquence>|MINimum|MAXimum|DEFault}  
[SOURce[1|2]:]FREQuency:STOP? [{MINimum|MAXimum}]

### MODE LISTE DE FRÉQUENCES

[SOURce[1|2]:]LIST:DWELL {<secondes>|MINimum|MAXimum}  
[SOURce[1|2]:]LIST:DWELL? [{MINimum|MAXimum}]

[SOURce[1|2]:]LIST:FREQuency <fréq1>[, <fréq2>, etc.]  
[SOURce[1|2]:]LIST:FREQuency?

[SOURce[1|2]:]LIST:FREQuency:POINts? [{MINimum|MAXimum}]

MMEMory:LOAD:LIST[1|2] <nom de fichier>

MMEMory:STORe:LIST[1|2] <nom de fichier>

## TENSION

[SOURce[1|2]:]VOLTage {< *amplitude* >|MINimum|MAXimum|DEFault}

[SOURce[1|2]:]VOLTage? [{MINimum|MAXimum}]

[SOURce[1|2]:]VOLTage:COUple[:STATe] {ON|1|OFF|0}

[SOURce[1|2]:]VOLTage:COUple[:STATe]?

[SOURce[1|2]:]VOLTage:HIGH {< *tension* >|MINimum|MAXimum|DEFault}

[SOURce[1|2]:]VOLTage:HIGH? [{MINimum|MAXimum}]

[SOURce[1|2]:]VOLTage:LOW {< *tension* >|MINimum|MAXimum|DEFault}

[SOURce[1|2]:]VOLTage:LOW? [{MINimum|MAXimum}]

[SOURce[1|2]:]VOLTage:LIMit:HIGH {< *tension* >|MINimum|MAXimum|DEFault}

[SOURce[1|2]:]VOLTage:LIMit:HIGH? [{MINimum|MAXimum}]

[SOURce[1|2]:]VOLTage:LIMit:LOW {< *tension* >|MINimum|MAXimum|DEFault}

[SOURce[1|2]:]VOLTage:LIMit:LOW? {MINimum|MAXimum}?

[SOURce[1|2]:]VOLTage:LIMit:STATe {ON|1|OFF|0}

[SOURce[1|2]:]VOLTage:LIMit:STATe?

[SOURce[1|2]:]VOLTage:OFFSet {< *tension résiduelle* >|MINimum|MAXimum|DEFault}

[SOURce[1|2]:]VOLTage:OFFSet? [{MINimum|MAXimum}]

[SOURce[1|2]:]VOLTage:RANGe:AUTO {OFF|0|ON|1|ONCE}

[SOURce[1|2]:]VOLTage:RANGe:AUTO?

[SOURce[1|2]:]VOLTage:UNIT {VPP|VRMS|DBM}

[SOURce[1|2]:]VOLTage:UNIT?

## SIGNAL CARRÉ

[SOURce[1|2]:]FUNCTion:SQUare:DCYcle {< *pourcentage* >|MINimum|MAXimum}

[SOURce[1|2]:]FUNCTion:SQUare:DCYcle? [{MINimum|MAXimum}]

[SOURce[1|2]:]FUNCTion:SQUare:PERiod {< *secondes* >|MINimum|MAXimum|DEFault}

[SOURce[1|2]:]FUNCTion:SQUare:PERiod? [{MINimum|MAXimum}]

## RAMPE

[SOURce[1|2]:]FUNCTion:RAMP:SYMMetry {< *pourcentage* >|MINimum|MAXimum|DEFault}

[SOURce[1|2]:]FUNCTion:RAMP:SYMMetry? [{MINimum|MAXimum}]

## BRUIT

[SOURce[1|2]:]FUNCTion:NOISe:BANDwidth {< *bande passante* >|MINimum|MAXimum|DEFault}

[SOURce[1|2]:]FUNCTion:NOISe:BANDwidth? [{MINimum|MAXimum}]

## PRBS

[SOURce[1|2]:]FUNction:PRBS:BRATe {<débit\_binaire>| MINimum|MAXimum|DEFault}

[SOURce[1|2]:]FUNction:PRBS:BRATe? [{MINimum|MAXimum}]

[SOURce[1|2]:]FUNction:PRBS:DATA <type\_séquence>

[SOURce[1|2]:]FUNction:PRBS:DATA?

[SOURce[1|2]:]FUNction:PRBS:TRANSition[:BOTH] {<secondes>|MINimum|MAXimum|DEFault}

[SOURce[1|2]:]FUNction:PRBS:TRANSition[:BOTH]? [{MINimum|MAXimum}]

## SIGNAL ARBITRAIRE

[SOURCE[1|2]:]FUNCTION:ARBITRARY {<nom de fichier>}

[SOURCE[1|2]:]FUNCTION:ARBITRARY?

[SOURCE[1|2]:]FUNCTION:ARBITRARY:ADVANCE {TRIGGER|SRATE}

[SOURCE[1|2]:]FUNCTION:ARBITRARY:ADVANCE?

[SOURCE[1|2]:]FUNCTION:ARBITRARY:FILTER {NORMAL|STEP|OFF}

[SOURCE[1|2]:]FUNCTION:ARBITRARY:FILTER?

[SOURCE[1|2]:]FUNCTION:ARBITRARY:FREQUENCY {<fréquence>|MINIMUM|MAXIMUM|DEFAULT}

[SOURCE[1|2]:]FUNCTION:ARBITRARY:FREQUENCY? {MINIMUM|MAXIMUM}

[SOURCE[1|2]:]FUNCTION:ARBITRARY:PERIOD {<période>|MINIMUM|MAXIMUM|DEFAULT}

[SOURCE[1|2]:]FUNCTION:ARBITRARY:PERIOD? {MINIMUM|MAXIMUM}

[SOURCE[1|2]:]FUNCTION:ARBITRARY:POINTS?

[SOURCE[1|2]:]FUNCTION:ARBITRARY:PTPEAK {<tension>|MINIMUM|MAXIMUM|DEFAULT}

[SOURCE[1|2]:]FUNCTION:ARBITRARY:PTPEAK? [{MINIMUM|MAXIMUM}]

[SOURCE[1|2]:]FUNCTION:ARBITRARY:SRATE {<fréquence\_échantillonnage>|MINIMUM|MAXIMUM|DEFAULT}

[SOURCE[1|2]:]FUNCTION:ARBITRARY:SRATE? {MINIMUM|MAXIMUM}

FUNCTION:ARBITRARY:BALANCE[:STATE] {ON|1|OFF|0} (**Option lecteur IQ uniquement**)

FUNCTION:ARBITRARY:BALANCE[:STATE]? (**Option lecteur IQ uniquement**)

FUNCTION:ARBITRARY:BALANCE:GAIN {<pourcentage>|MINIMUM|MAXIMUM|DEFINE} (**Option lecteur IQ uniquement**)

FUNCTION:ARBITRARY:BALANCE:GAIN? [{MINIMUM|MAXIMUM}] (**Option lecteur IQ uniquement**)

FUNCTION:ARBITRARY:BALANCE:OFFSET{1|2} {<volts>|MINIMUM|MAXIMUM|DEFAULT} (**Option lecteur IQ uniquement**)

FUNCTION:ARBITRARY:BALANCE:OFFSET{1|2}? [MINIMUM|MAXIMUM] (**Option lecteur IQ uniquement**)

FUNCTION:ARBITRARY:SKEW[:STATE] {ON|1|OFF|0} (**Option lecteur IQ uniquement**)

FUNCTION:ARBITRARY:SKEW[:STATE]? (**Option lecteur IQ uniquement**)

FUNCTION:ARBITRARY:SKEW:TIME [{<temps>|MINIMUM|MAXIMUM|DEFAULT}] (**Option lecteur IQ uniquement**)

FUNCTION:ARBITRARY:SKEW:TIME? [{MINIMUM|MAXIMUM}] (**Option lecteur IQ uniquement**)

[SOURCE[1|2]:]FUNCTION:ARBITRARY:SYNCHRONIZE

[SOURCE[1|2]:]RATE:COUPLE[:STATE] {ON|1|OFF|0}

[SOURCE[1|2]:]RATE:COUPLE[:STATE]?

[SOURCE[1|2]:]RATE:COUPLE:MODE {OFFSET|RATIO}

[SOURCE[1|2]:]RATE:COUPLE:MODE?

[SOURCE[1|2]:]RATE:COUPLE:OFFSET {<fréquence\_échantillonnage>|MINIMUM|MAXIMUM|DEFAULT}

[SOURCE[1|2]:]RATE:COUPLE:OFFSET?

[SOURCE[1|2]:]RATE:COUPLE:RATIO {<rapport>|MINIMUM|MAXIMUM}

[SOURCE[1|2]:]RATE:COUPLE:RATIO? [{MINIMUM|MAXIMUM}]

## SORTIE

OUTPut[1|2] {ON|1|OFF|0}

OUTPut[1|2]?

OUTPut[1|2]:LOAD {<ohms>|INFinity|MINimum|MAXimum|DEFault}

OUTPut[1|2]:LOAD? [{MINimum|MAXimum}]

OUTPut[1|2]:MODE {NORMal|GATed}

OUTPut[1|2]:MODE?

OUTPut[1|2]:POLarity {NORMal|INVerted}

OUTPut[1|2]:POLarity?

OUTPut:SYNC {ON|1|OFF|0}

OUTPut:SYNC?

OUTPut[1|2]:SYNC:MODE {NORMal|CARRier|MARKer}

OUTPut[1|2]:SYNC:MODE?

OUTPut[1|2]:SYNC:POLarity {NORMal|INVerted}

OUTPut[1|2]:SYNC:POLarity?

OUTPut:SYNC:SOURce {CH1|CH2}

OUTPut:SYNC:SOURce?

OUTPut:TRIGger {ON|1|OFF|0}

OUTPut:TRIGger?

OUTPut:TRIGger:SLOPe {POSitive|NEGative}

OUTPut:TRIGger:SLOPe?

OUTPut:TRIGger:SOURce {CH1|CH2}

OUTPut:TRIGger:SOURce?

## Commandes de configuration des impulsions

[SOURce[1|2]:]FUNction:PULSe:DCYClE {<pourcentage>|MINimum|MAXimum|DEFault}

[SOURce[1|2]:]FUNction:PULSe:DCYClE? [{MINimum|MAXimum}]

[SOURce[1|2]:]FUNction:PULSe:HOLD {WIDTh|DCYClE}

[SOURce[1|2]:]FUNction:PULSe:HOLD?

[SOURce[1|2]:]FUNction:PULSe:PERiod {<secondes>|MINimum|MAXimum|DEFault}

[SOURce[1|2]:]FUNction:PULSe:PERiod? [{MINimum|MAXimum}]

[SOURce[1|2]:]FUNction:PULSe:TRANSition[:BOTH] {<secondes>|MINimum|MAXimum|DEFault}

[SOURce[1|2]:]FUNction:PULSe:TRANSition:LEADing {<secondes>|MINimum|MAXimum|DEFault}

[SOURce[1|2]:]FUNction:PULSe:TRANSition:LEADing? [{MINimum|MAXimum}]

[SOURce[1|2]:]FUNction:PULSe:TRANSition:TRAILing {<secondes>|MINimum|MAXimum|DEFault}

[SOURce[1|2]:]FUNction:PULSe:TRANSition:TRAILing? [{MINimum|MAXimum}]

[SOURce[1|2]:]FUNction:PULSe:WIDTh {<secondes>|MINimum|MAXimum|DEFault}

[SOURce[1|2]:]FUNction:PULSe:WIDTh? [{MINimum|MAXimum}]

## Commandes de modulation

### AM

[SOURce[1|2]:]AM[:DEPT]h {<profondeur\_en\_pourcentage>|MINimum|MAXimum}  
[SOURce[1|2]:]AM[:DEPT]h? [{MINimum|MAXimum}]

[SOURce[1|2]:]AM:DSSC {ON|1|OFF|0}  
[SOURce[1|2]:]AM:DSSC?

[SOURce[1|2]:]AM:INTernal:FREQuency {<fréquence>|MINimum|MAXimum|DEFault}  
[SOURce[1|2]:]AM:INTernal:FREQuency? [{MINimum|MAXimum}]

[SOURce[1|2]:]AM:INTernal:FUNCTion <fonction>  
[SOURce[1|2]:]AM:INTernal:FUNCTion?

[SOURce[1|2]:]AM:SOURce {INTernal|EXTernal|CH1|CH2}  
[SOURce[1|2]:]AM:SOURce?

[SOURce[1|2]:]AM:STATe {ON|1|OFF|0}  
[SOURce[1|2]:]AM:STATe?

### FM

[SOURce[1|2]:]FM[:DEVI]ation {<variation\_crête\_en\_Hz>|MINimum|MAXimum|DEFault}  
[SOURce[1|2]:]FM[:DEVI]ation? [{MINimum|MAXimum}]

[SOURce[1|2]:]FM:INTernal:FREQuency {<fréquence>|MINimum|MAXimum|DEFault}  
[SOURce[1|2]:]FM:INTernal:FREQuency? [{MINimum|MAXimum}]

[SOURce[1|2]:]FM:INTernal:FUNCTion <fonction>  
[SOURce[1|2]:]FM:INTernal:FUNCTion?

[SOURce[1|2]:]FM:SOURce {INTernal|EXTernal|CH1|CH2}  
[SOURce[1|2]:]FM:SOURce?

[SOURce[1|2]:]FM:STATe {ON|1|OFF|0}  
[SOURce[1|2]:]FM:STATe?

### Commandes BPSK

[SOURce[1|2]:]BPSK:SOURce {INTernal|EXTernal}  
[SOURce[1|2]:]BPSK:SOURce?

[SOURce[1|2]:]BPSK:STATe {ON|1|OFF|0}  
[SOURce[1|2]:]BPSK:STATe?

[SOURce[1|2]:]BPSK:INTernal:RATE {<fréquence\_modulante>|MINimum|MAXimum|DEFault}  
[SOURce[1|2]:]BPSK:INTernal:RATE? [{MINimum|MAXimum}]

[SOURce[1|2]:]BPSK[:PHAS]e {<angle>|MINimum|MAXimum|DEFault}  
[SOURce[1|2]:]BPSK[:PHAS]e? [{MINimum|MAXimum}]

## PM

[SOURce[1|2]:]PM:DEVIation {<variation en degrés>|MINimum|MAXimum|DEFAULT}

[SOURce[1|2]:]PM:DEVIation? [{MINimum|MAXimum}]

[SOURce[1|2]:]PM:INTernal:FREQuency {<fréquence>|MINimum|MAXimum|DEFAULT}

[SOURce[1|2]:]PM:INTernal:FREQuency? [{MINimum|MAXimum}]

[SOURce[1|2]:]PM:INTernal:FUNCTion <fonction>

[SOURce[1|2]:]PM:INTernal:FUNCTion?

[SOURce[1|2]:]PM:SOURce {INTernal|EXTernal|CH1|CH2}

[SOURce[1|2]:]PM:SOURce?

[SOURce[1|2]:]PM:STATe {ON|1|OFF|0}

[SOURce[1|2]:]PM:STATe?

## FSK

[SOURce[1|2]:]FSKey:FREQuency {<fréquence>|MINimum|MAXimum|DEFAULT}

[SOURce[1|2]:]FSKey:FREQuency? [{MINimum|MAXimum}]

[SOURce[1|2]:]FSKey:INTernal:RATE {<fréquence\_en\_Hz>|MINimum|MAXimum}

[SOURce[1|2]:]FSKey:INTernal:RATE? [{MINimum|MAXimum}]

[SOURce[1|2]:]FSKey:SOURce {INTernal|EXTernal}

[SOURce[1|2]:]FSKey:SOURce?

[SOURce[1|2]:]FSKey:STATe {ON|1|OFF|0}

[SOURce[1|2]:]FSKey:STATe?

## PWM

[SOURce[1|2]:]PWM:DEVIation {<variation>|MINimum|MAXimum|DEFAULT}

[SOURce[1|2]:]PWM:DEVIation? [{MINimum|MAXimum}]

[SOURce[1|2]:]PWM:DEVIation:DCYClE {<variation\_en\_pct>|MINimum|MAXimum|DEFAULT}

[SOURce[1|2]:]PWM:DEVIation:DCYClE? [{MINimum|MAXimum}]

[SOURce[1|2]:]PWM:INTernal:FREQuency {<fréquence>|MINimum|MAXimum|DEFAULT}

[SOURce[1|2]:]PWM:INTernal:FREQuency? [{MINimum|MAXimum}]

[SOURce[1|2]:]PWM:INTernal:FUNCTion <fonction>

[SOURce[1|2]:]PWM:INTernal:FUNCTion?

[SOURce[1|2]:]PWM:SOURce {INTernal|EXTernal|CH1|CH2}

[SOURce[1|2]:]PWM:SOURce?

[SOURce[1|2]:]PWM:STATe {ON|1|OFF|0}

[SOURce[1|2]:]PWM:STATe?



## SUM

[SOURCE[1|2]:]SUM:AMPLitude {<amplitude>|MINimum|MAXimum|DEFAULT}

[SOURCE[1|2]:]SUM:AMPLitude? [{MINimum|MAXimum}]

[SOURCE[1|2]:]SUM:INTERNAL:FREQUENCY {<fréquence>|MINimum|MAXimum|DEFAULT}

[SOURCE[1|2]:]SUM:INTERNAL:FREQUENCY? [{MINimum|MAXimum}]

[SOURCE[1|2]:]SUM:INTERNAL:FUNCTION <fonction>

[SOURCE[1|2]:]SUM:INTERNAL:FUNCTION?

[SOURCE[1|2]:]SUM:SOURCE {INTERNAL|EXTERNAL|CH1|CH2}

[SOURCE[1|2]:]SUM:SOURCE?

[SOURCE[1|2]:]SUM:STATE {ON|1|OFF|0}

[SOURCE[1|2]:]SUM:STATE?

## Balayage de fréquence

[SOURCE[1|2]:]SWEep:HTIME {<temps\_maintien>|MINimum|MAXimum|DEFAULT}

[SOURCE[1|2]:]SWEep:HTIME? [{MINimum|MAXimum}]

[SOURCE[1|2]:]SWEep:RTIME {<temps\_retour>|MINimum|MAXimum|DEFAULT}

[SOURCE[1|2]:]SWEep:RTIME? [{MINimum|MAXimum}]

[SOURCE[1|2]:]SWEep:SPACing {LINEar|LOGarithmic}

[SOURCE[1|2]:]SWEep:SPACing?

[SOURCE[1|2]:]SWEep:STATE {ON|1|OFF|0}

[SOURCE[1|2]:]SWEep:STATE?

[SOURCE[1|2]:]SWEep:TIME {<secondes>|MINimum|MAXimum|DEFAULT}

[SOURCE[1|2]:]SWEep:TIME? [{MINimum|MAXimum}]

## Mode rafale

[SOURCE[1|2]:]BURSt:GATE:POLarity {NORMAL|INVERTed}

[SOURCE[1|2]:]BURSt:GATE:POLarity?

[SOURCE[1|2]:]BURSt:INTERNAL:PERiod {<secondes>|MINimum|MAXimum}

[SOURCE[1|2]:]BURSt:INTERNAL:PERiod? [{MINimum|MAXimum}]

[SOURCE[1|2]:]BURSt:MODE {TRIGgered|GATed}

[SOURCE[1|2]:]BURSt:MODE?

[SOURCE[1|2]:]BURSt:NCYCles {<num\_cycles>|INFinity|MINimum|MAXimum}

[SOURCE[1|2]:]BURSt:NCYCles? [{MINimum|MAXimum}]

[SOURCE[1|2]:]BURSt:PHASe {<angle>|MINimum|MAXimum}

[SOURCE[1|2]:]BURSt:PHASe? [{MINimum|MAXimum}]

[SOURCE[1|2]:]BURSt:STATE {ON|1|OFF|0}

[SOURCE[1|2]:]BURSt:STATE?

## Marqueur

[SOURce[1|2]:]MARKer:CYCle {<num\_cycle>|MINimum|MAXimum|DEFault}

[SOURce[1|2]:]MARKer:FREQuency {<fréquence>|MINimum|MAXimum|DEFault}

[SOURce[1|2]:]MARKer:POINt {<nombre\_échantillons>|MINimum|MAXimum}

## Configuration des déclenchements

TRIGger[1|2]

TRIGger[1|2]:COUNT {<nombre>|MINimum|MAXimum|DEFault}

TRIGger[1|2]:COUNT? [{MINimum|MAXimum}]

TRIGger[1|2]:DELay {<secondes>|MINimum|MAXimum}

TRIGger[1|2]:DELay? [{MINimum|MAXimum}]

TRIGger[1|2]:LEVel {<niveau>|MINimum|MAXimum}

TRIGger[1|2]:LEVel? [{MINimum|MAXimum}]

TRIGger[1|2]:SLOPe {POSitive|NEGative}

TRIGger[1|2]:SLOPe?

TRIGger[1|2]:SOURce {IMMediate|EXTernal|TIMER|BUS}

TRIGger[1|2]:SOURce?

TRIGger[1|2]:TIMER {<secondes>|MINimum|MAXimum}

TRIGger[1|2]:TIMER? [{MINimum|MAXimum}]

## Enregistrement des états

MEMory:NSTates?

MEMory:STATe:CATalog?

MEMory:STATe:DElete {0|1|2|3|4}

MEMory:STATe:NAME {0|1|2|3|4} [, <nom>]

MEMory:STATe:NAME? {0|1|2|3|4}

MEMory:STATe:RECall:AUTO {ON|1|OFF|0}

MEMory:STATe:RECall:AUTO?

MEMory:STATe:VALid? {0|1|2|3|4}

## Mémoire de masse

MMEMory:CATalog[:ALL]? [<dossier>]

MMEMory:CATalog:DATA:ARbitrary? [<dossier>]

MMEMory:CATalog:STATe? [<dossier>]

MMEMory:CDIRectory <dossier>

MMEMory:CDIRectory?

MMEMory:COpy <fichier 1>,<fichier 2>

MMEMory:COpy:SEquence <source>,<destination>

MMEMory:DElete <fichier>

MMEMory:DOWNload:DATA <bloc\_binaire>

MMEMory:DOWNload:FNAME <nom de fichier>

MMEMory:LOAD:ALL <nom de fichier>

MMEMory:LOAD:DATA[1|2] <nom de fichier>

MMEMory:LOAD:LIST[1|2] <nom de fichier>

MMEMory:LOAD:STATe <nom de fichier>

MMEMory:MDIRectory <dossier>

MMEMory:MOVE <fichier 1>,<fichier 2>

MMEMory:RDIRectory <dossier>

MMEMory:STORe:ALL <nom de fichier>

MMEMory:STORe:DATA[1|2] <nom de fichier>

MMEMory:STORe:LIST[1|2] <nom de fichier>

MMEMory:STORe:STATe <nom de fichier>

MMEMory:UPLoad? <nom de fichier>

## Affichage

DISPlay {ON|1|OFF|0}

DISPlay?

DISPlay:TEXT "<chaîne de caractères>"

DISPlay:TEXT?

DISPlay:TEXT:CLEar

DISPlay:UNIT:ARBRate {SRATe|FREQuency|PERiod}

DISPlay:UNIT:PULse {WIDTh|DUTY}

DISPlay:UNIT:RATE {FREQuency|PERiod}

DISPlay:UNIT:SWEep {STARtstop|CENTerspan}

DISPlay:UNIT:VOLT {AMPLitudeoff|HIGHlow}

DISPlay:VIEW {STANdard|TEXT|GRAPh|DUAL}

## Captures d'écran

HCOPy:SDUMp:DATA?

HCOPy:SDUMp:DATA:FORMat {PNG|BMP}

HCOPy:SDUMp:DATA:FORMat?

## LXI

LXI:IDENtify[:STATE] {ON|1|OFF|0}

LXI:IDENtify[:STATE]?

LXI:MDNS:ENABle {ON|1|OFF|0}

LXI:MDNS:ENABle?

LXI:MDNS:HNAME:RESolved?

LXI:MDNS:SNAME:DESired <nom>

LXI:MDNS:SNAME:DESired?

LXI:MDNS:SNAME[:RESolved]?

LXI:RESet

LXI:REStart

## Configuration de l'interface distante

SYSTem:COMMunicate:ENABle {ON|1|OFF|0}, <interface>

SYSTem:COMMunicate:ENABle? <interface>

SYSTem:COMMunicate:GPIB:ADDRes <adresse>

SYSTem:COMMunicate:GPIB:ADDRes?

SYSTem:COMMunicate:LAN:CONTRol?

SYSTem:COMMunicate:LAN:DHCP {ON|1|OFF|0}

SYSTem:COMMunicate:LAN:DHCP?

SYSTem:COMMunicate:LAN:DNS[1|2] "<adresse>"

SYSTem:COMMunicate:LAN:DNS[1|2]? [{CURRent|STATic}]

SYSTem:COMMunicate:LAN:DOMain?

SYSTem:COMMunicate:LAN:GATeway "<adresse>"

SYSTem:COMMunicate:LAN:GATeway? [{CURRent|STATic}]

SYSTem:COMMunicate:LAN:HOSTname "<nom>"

SYSTem:COMMunicate:LAN:HOSTname? [{CURRent|STATic}]

SYSTem:COMMunicate:LAN:IPADdress "<adresse>"

SYSTem:COMMunicate:LAN:IPADdress? [{CURRent|STATic}]

SYSTem:COMMunicate:LAN:MAC?

SYSTem:COMMunicate:LAN:SMASk "<masque>"

SYSTem:COMMunicate:LAN:SMASk? [{CURRent|STATic}]

SYSTem:COMMunicate:LAN:TELNet:PROMpt "<chaîne de caractères>"

SYSTem:COMMunicate:LAN:TELNet:PROMpt?

SYSTem:COMMunicate:LAN:TELNet:WMESsage "<chaîne de caractères>"

SYSTem:COMMunicate:LAN:TELNet:WMESsage?

SYSTem:COMMunicate:LAN:UPDate

SYSTem:COMMunicate:LAN:WINS[1|2] "<adresse>"

SYSTem:COMMunicate:LAN:WINS[1|2]? [{CURRent|STATic}]

## Systeme

SYSTem:BEEPer[:IMMEDIATE]

SYSTem:BEEPer:STATe {ON|1|OFF|0}

SYSTem:BEEPer:STATe?

SYSTem:CLICk:STATe{ON|1|OFF|0}

SYSTem:CLICk:STATe?

SYSTem:DATE <aaaa>, <mm>, <jj>

SYSTem:DATE?

SYSTem:ERRor?

SYSTem:LICense:CATalog?

SYSTem:LICense:DELeTe "<nom\_option>"

SYSTem:LICense:DELeTe:ALL

SYSTem:LICense:DESCRiption? "<nom\_option>"

SYSTem:LICense:ERRor?

SYSTem:LICense:ERRor:COUNT?

SYSTem:LICense:INSTall "<fichier>"

SYSTem:LICense:INSTall? "<option>"

SYSTem:LOCK:NAME?

SYSTem:LOCK:OWNer?

SYSTem:LOCK:RELease

SYSTem:LOCK:REQuest?

SYSTem:SECurity:IMMEDIATE

SYSTem:TIME <hh>, <mm>, <ss>

SYSTem:TIME?

SYSTem:VERSion?

## Phase

[SOURce[1|2]:]PHASe {<angle>|MINimum|MAXimum|DEFault}

[SOURce[1|2]:]PHASe? [{MINimum|MAXimum}]

[SOURce[1|2]:]PHASe:ARBitrary {<angle>|MINimum|MAXimum}

[SOURce[1|2]:]PHASe:MODulation {<angle>|MINimum|MAXimum}

[SOURce[1|2]:]PHASe:MODulation?

[SOURce[1|2]:]PHASe:REFerence

[SOURce[1|2]:]PHASe:SYNChronize

[SOURce[1|2]:]PHASe:UNLock:ERRor:STATe {ON|1|OFF|0}

[SOURce[1|2]:]PHASe:UNLock:ERRor:STATe?

## Oscillateur de référence

ROSCillator:SOURce {INTernal|EXTernal}

ROSCillator:SOURce?

ROSCillator:SOURce:AUTO {ON|OFF}

ROSCillator:SOURce:AUTO?

ROSCillator:SOURce:CURRent?

## Étalonnage

CALibration[:ALL]?

CALibration:COUNT?

CALibration:SECure:CODE <nouveau\_code>

CALibration:SECure:STATe {ON|1|OFF|0} [, <code>]

CALibration:SECure:STATe?

CALibration:SETup <étape>

CALibration:SETup?

CALibration:STORE

CALibration:STRing "<chaîne de caractères>"

CALibration:STRing?

CALibration:VALue <valeur>

CALibration:VALue?

## IEEE-488

\*CLS

\*ESE <*valeur\_activation*>

\*ESE?

\*ESR?

\*IDN?

\*OPC

\*OPC?

\*OPT?

\*PSC {0|1}

\*PSC?

\*RCL {0|1|2|3|4}

\*RST

\*SAV {0|1|2|3|4}

\*SRE <*valeur\_activation*>

\*SRE?

\*STB?

\*TRG

\*TST?

\*WAI

## État

STATus:OPERation:CONDition?

STATus:OPERation:ENABle <*valeur\_activation*>

STATus:OPERation:ENABle?

STATus:OPERation[:EVENT]?

STATus:PRESet

STATus:QUEStionable:CONDition?

STATus:QUEStionable:ENABle <*valeur\_activation*>

STATus:QUEStionable:ENABle?

STATus:QUEStionable[:EVENT]?



## Divers

### ABORt

[SOURce[1|2]:]PHASe:ARBitrary {<angle>|MINimum|MAXimum}

[SOURce[1|2]:]PHASe:ARBitrary?

[SOURce[1|2]:]COMBine:FEED {CH1|CH2|NONE}

[SOURce[1|2]:]COMBine:FEED?

FORMat:BORDER {NORMal|SWAPped}

FORMat:BORDER?

INITiate[1|2]:CONTInuous {ON|1|OFF|0}

INITiate[1|2]:CONTInuous?

INITiate:CONTInuous:ALL {ON|1|OFF|0}

INITiate[1|2]:IMMediate]

INITiate[:IMMediate]:ALL

[SOURce[1|2]:]MARKer:CYCLE {<num\_cycle>|MINimum|MAXimum|DEFault}

[SOURce[1|2]:]MARKer:CYCLE? [{MINimum|MAXimum}]

INPut:ATTenuation[:STATe] {ON|1|OFF|0}

INPut:ATTenuation[:STATe]?

[SOURce[1|2]:]MARKer:FREQuency {<fréquence>|MINimum|MAXimum|DEFault}

[SOURce[1|2]:]MARKer:FREQuency? [{MINimum|MAXimum}]

[SOURce[1|2]:]MARKer:POINt {<nombre\_échantillons>|MINimum|MAXimum}

[SOURce[1|2]:]MARKer:POINt? [{MINimum|MAXimum}]

[SOURce[1|2]:]TRACk {ON|OFF|INVerted}

TRACk?

UNIT:ANGLE {DEGREE|RADian|SECond|DEFault}

UNIT:ANGLE?

UNIT:ARBitrary:ANGLE {DEGREE|RADian|SECond|SAMPlE|DEFault}

UNIT:ARBitrary:ANGLE?

## Réinitialisation de la configuration d'usine

Les tableaux suivants présentent les paramètres configurés par défaut en usine. Les paramètres signalés par une puce (·) ne sont pas volatiles ; ils ne sont pas affectés par une remise sous tension ou l'exécution de la commande \*RST. Les autres paramètres sont volatiles et réinitialisés avec les valeurs indiquées à la mise sous tension ou après l'exécution de la commande \*RST.

### REMARQUE

La configuration à la mise sous tension ou après une réinitialisation peut être différente de celle indiquée ci-dessous si vous avez activé le mode de rappel de la configuration à la mise sous tension dans le menu **[System]**. Reportez-vous à la section **Enregistrement des états de l'instrument**.

<b>Configuration de la voie de sortie</b>	
Fonction	Sinusoidal
Suivi	Désactivé
Fréquence	1 kHz
Mode de fréquence	CW
Configuration du couplage des fréquences	OFF
Mode de couplage des fréquences	Rapport
Rapport de couplage des fréquences	1
Décalage de couplage des fréquences	0
Amplitude	100 mVpp
Tension résiduelle	0 Vcc
Configuration du couplage des tensions	OFF
Configuration des limites de tension	OFF
Tension limite maximale	5 V
Tension limite minimale	-5 V
Unité de tension	VPP
Plage de tension	AUTO
Configuration	OFF
Charge	50 $\Omega$
Polarité	Normale
Mode (Normal ou Commandé)	Normal
Polarité de synchronisation	Normale
Mode de synchronisation	Normal
<b>Configuration de la voie de sortie</b>	

Configuration de la synchronisation	ON
Source de synchronisation	CH1
Source de déclenchement	CH1
Pente de déclenchement	Positive
Configuration du déclenchement	OFF
<b>Bruit</b>	
Bande passante	100 kHz
<b>PRBS</b>	
Données	PN7
Vitesse de transmission	1 kbit/s
Transition	8,4E-09
<b>Impulsion</b>	
Rapport cyclique	10%
Période	1 ms
Front montant/descendant	10 ns
Largeur	0,1 ms
<b>Rampe</b>	
Symétrie	100
<b>Carré</b>	
Rapport cyclique	50%
Période	1 ms
<b>Signaux arbitraires</b>	
Arb	Montée exponentielle
Filtre	PALIERS
Fréquence d'échantillonnage	40 k.éch/s
Incrémentation	SRATE
Point de marqueur	Point médian du signal arbitraire

<b>Modulation d'amplitude</b>	
Configuration	OFF
Source de modulation	Interne
Fonction interne	Sinusoidal
Fréquence interne	100 Hz
Profondeur	100 %
DSSC	OFF
<b>Modulation de fréquence</b>	
Configuration	OFF
Source de modulation	Interne
Fonction interne	Sinusoidal
Fréquence interne	10 Hz
Variation	100 Hz
<b>Modulation FSK</b>	
Configuration	OFF
Source de modulation	Interne
Fréquence interne	10 Hz
Fréquence	100 Hz
<b>Modulation de phase</b>	
Configuration	OFF
Source de modulation	Interne
Fonction	Sinusoidal
Fréquence	10 Hz
Variation	180 degrés
<b>Modulation BPSK</b>	
Configuration	OFF
Source de modulation	Interne
Fréquence interne	10 Hz
Phase	180 degrés
<b>Modulation de largeur d'impulsion</b>	

Configuration	OFF
Source de modulation	Interne
Fonction	Sinusoïdal
Fréquence	10 Hz
Variation	1 % ou 1E-5 sec en fonction de la spécification
<b>SUM</b>	
Configuration	OFF
Source	Interne
Fonction	Sinusoïdal
Fréquence	100 Hz
Amplitude du signal Sum	0,10 %
<b>Contrôle de phase</b>	
Réglage de phase	0 degré
Déverrouillage de condition d'erreur	OFF
Unités	degrés
<b>Oscillateur de référence</b>	
Source automatique	ON
Source	Interne
<b>Rafale</b>	
Configuration	OFF
Polarité de déclenchement	Normale
Mode	Déclenché
Cycles	1
Période	10 ms
Phase	0 degré
Cycle du marqueur	2
<b>Balayage</b>	
Configuration	OFF
Espacement	Linéaire

Fréquence initiale	100 Hz
Fréquence finale	1 kHz
Fréquence médiane	550 Hz
Plage	900 Hz
Fréquence du marqueur	500 Hz
Temps de balayage	1 s
Temps de maintien	0 s
Temps de retour	0 s
<b>Liste</b>	
Fréquence	100, 1000, 550 Hz
Points	3
Délai	1 s
<b>Déclenchement</b>	
Retard	0 s
Pente	Positive
Source	Immédiat
Temporisation	1 s
Init. continue	ON
Nombre	1
<b>Configuration des déclenchements indépendants de la voie</b>	
Init. continue Tous	ON
<b>Divers</b>	
Ordre des octets de format	Normal
Source Combine	AUCUNE
<b>Les éléments suivants ne s'appliquent pas à la configuration des voies.</b>	
<b>Écran</b>	
Configuration	ON
Texte	""

Format papier	PNG
<b>Communication de l'interface distante</b>	
Adresse GPIB •	10
DHCP •	Activé
Adresse IP statique •	169.254.5.21
Masque de sous-réseau statique •	255.255.0.0
Passerelle statique •	0.0.0.0
Serveur principal DNS •	0.0.0.0
Serveur secondaire DNS •	0.0.0.0
Nom d'hôte statique •	« A-335xxx-nnnnn » ou « A-335xxx-nnnnn », où xxxx correspond aux 3 derniers chiffres du numéro du modèle et nnnnn aux 5 derniers chiffres du numéro de série de l'instrument
Invite Telnet •	33xxxx>, où xxxx correspond aux 4 derniers chiffres du numéro du modèle.
Message d'accueil Telnet •	Bienvenue sur le Générateur de signaux 33xxxx d'Keysight, où xxxx correspond aux 4 derniers chiffres du numéro du modèle.
Serveur principal WINS •	0.0.0.0
Serveur secondaire WINS •	0.0.0.0
<b>Système</b>	
Configuration du signal sonore	ON
Rappel à l'extinction de l'instrument •	OFF
<b>LXI</b>	
Identification	OFF
<b>Étalonnage</b>	
Configuration de l'étalonnage	Sécurisée

**REMARQUE**

L'instrument utilise le port 5024 du réseau local pour les sessions Telnet SCPI et le port 5025 pour les sessions sur socket SCPI.

## Messages d'erreur SCPI

L'instrument renvoie des messages d'erreur conformes à la norme SCPI.

- Il est possible d'enregistrer jusqu'à 20 erreurs de syntaxe de commande ou matérielles dans chaque liste des erreurs des interfaces (une pour chaque erreur GPIB, USB, VXI-11 et Telnet/Sockets). Les erreurs sont affichées dans la file d'erreurs de la session d'E/S ayant provoqué l'erreur.
- L'instrument émet un signal sonore chaque fois qu'une erreur se produit (sauf si cette fonction est désactivée par la commande **SYSTem:BEEPer:STATe OFF**). Le voyant **ERROR** de la face avant s'allume si la file d'erreurs contient une ou plusieurs erreurs.
- Une file d'erreurs globales spéciale contient toutes les erreurs matérielles et détectées à la mise sous tension (par ex., température excessive).
- Erreur de récupération « premier entré/premier sorti » ; ces erreurs sont effacées après leur lecture. Après la lecture de toutes les erreurs spécifiques aux interfaces, les erreurs figurant dans la liste globale sont récupérées. Une fois que vous avez lu toutes les erreurs de la liste globale des erreurs, le voyant **ERROR** s'éteint.
- Si plus de 20 erreurs se sont produites, la dernière erreur enregistrée (la plus récente) est remplacée par -350,"Error queue overflow". Aucune erreur supplémentaire n'est enregistrée jusqu'à ce que vous en supprimiez dans la file. Si aucune erreur ne s'est produite depuis la dernière consultation de la file d'erreurs, l'instrument affiche le message suivant : +0,"No error".
- La face avant signale les erreurs de toutes les sessions d'E/S et de la liste globale des erreurs. Pour lire la liste des erreurs sur la face avant, appuyez sur la touche [**System**], puis sur la touche de fonction **Help**. Sélectionnez ensuite « Afficher la file d'erreurs de commande à distance » dans le menu Help.
- Les conditions d'erreur sont également récapitulées dans le registre d'octet d'état. Pour de plus amples informations, reportez-vous à la section **Présentation du sous-système STATus**.
- Les files d'erreurs propres à l'interface sont effacées lors des remises sous tension et de l'exécution de la commande **\*CLS**. La commande **\*RST** n'efface pas la liste des erreurs.
- **SCPI:**

**SYSTem:ERRor?** Lire et effacer une erreur de la file

Les erreurs présentent le format suivant (la chaîne d'erreur peut contenir jusqu'à 255 caractères) :

-113,"Undefined header"

-315 Configuration memory lost; due to firmware revision change

-315 Configuration memory lost; memory corruption detected

-314 Save/recall memory lost; due to firmware revision change

-314 Save/recall memory lost; memory corruption detected

-313 Calibration memory lost

-313 Calibration memory lost; due to firmware revision change

-313 Cannot read file; due to corrupt data



- 313 Cannot read file; due to file revision change
- 313 Invalid number of channels for operation
- 310 System error; internal software error
- 310 System error; out of memory
- 310 System error; software initialization failed
- 292 Referenced name does not exist
- 257 File name error;
  - access denied
  - drive name missing or not recognized
  - file or folder already exists
  - file too large
  - folder is default folder
  - folder not empty
  - invalid character in name
  - not a folder name
  - path is a folder name
  - path name missing
  - path too long
  - relative path not allowed
  - unknown file extension
- 256 File or folder name not found
- 254 Media full
- 252 Missing media
- 250 Mass storage error: file read/write error
- 241 Hardware missing
- 241 Hardware missing; Command not valid in one channel instrument.
- 240 Hardware error; GPIB interface failed
- 230 Data corrupt or stale
- 222 Data out of range;
  - AM depth
  - amplitude

arb frequency  
arb period  
burst count  
burst count limited by length of burst  
burst period  
burst period limited by length of burst  
cannot combine channel with itself. Combine disabled  
duty cycle  
duty cycle limited by frequency  
FM deviation  
FM deviation limited by maximum frequency  
FM deviation limited by minimum frequency  
frequency  
frequency in burst mode  
frequency in FM  
high level limited by high soft limit  
high level limited by low level  
high level limited by low soft limit  
high limit value limited by high signal level  
large period limits minimum pulse width  
low level limited by high level  
low level limited by high soft limit  
low level limited by low soft limit  
low limit value limited by low signal level  
marker confined to burst cycles  
marker confined to sweep span  
offset  
period  
PRBS edge time  
PRBS edge time limited by bit rate  
pulse duty cycle limited by period

pulse edge at maximum  
pulse edge at minimum  
pulse edge time  
pulse edge time limited by duty cycle  
pulse edge time limited by period  
pulse edge time limited by width  
pulse frequency  
pulse period  
pulse width  
pulse width limited by period  
PWM deviation  
PWM deviation limited by pulse parameters  
ramp frequency  
ramp Symmetry  
Sample rate  
sample rate clipped to lower limit  
sample rate clipped to upper limit  
square edge time  
square edge time limited by duty cycle  
square edge time limited by period  
square edge time limited by width  
square period  
square width  
sum amplitude limited by channel or combine amplitudes  
sum amplitude value clipped to lower limit  
sweep time  
Track exceeds limits on channel 1. Tracking disabled  
Track exceeds limits on channel 2. Tracking disabled  
trigger count clipped to lower limit  
trigger count clipped to upper limit  
trigger delay

- trigger delay clipped to lower limit
  - trigger delay clipped to upper limit
  - trigger delay limited by length of burst
  - trigger level clipped to lower limit (série 33600 uniquement)
  - trigger level clipped to upper limit (série 33600 uniquement)
  - trigger level (série 33600 uniquement)
  - trigger timer clipped to lower limit
  - trigger timer clipped to upper limit
  - trigger timer limited by length of burst
  - user frequency
  - USER setting only valid for channel 1
  - value clipped to dwell time's lower limit
  - value clipped to dwell time's upper limit
  - value clipped to lower limit
  - value clipped to sweep time's lower limit
  - value clipped to upper limit
  - value limited due to coupling
- 222 List Data out of range; Arb frequency : Mode is changed to Normal (série 33600 uniquement)
  - 222 List Data out of range; Pulse frequency : Mode is changed to Normal
  - 222 List Data out of range; Ramp frequency : Mode is changed to Normal
  - 222 List Data out of range; Sine frequency : Mode is changed to Normal
  - 222 List Data out of range; Square frequency : Mode is changed to Normal
  - 222 List Data out of range; User frequency : Mode is changed to Normal
  - 221 Setting the advance mode to trigger forced the trigger source to external.
  - 221 Setting the Arb Filter OFF changed the maximum sample rate value to 6.25e7.
  - 221 Setting the trigger source changed the arb advance mode.
  - 221 Settings conflict;
    - 50V input range not compatible with 50 ohm input impedance; impedance set to 1 Mohm
    - AM depth forced amplitude change
    - AM turned off by selection of other mode or modulation

amplitude changed due to function

amplitude changed due to offset

amplitude units changed to Vpp due to high-Z load

amplitude units changed to Vpp, dBm and Vrms not applicable to arb sequences

amplitude units unchanged, dBm and Vrms not applicable to arb sequences

arb advance changed to SRATE due to filter (série 33600 uniquement)

arb advance changed to SRATE due to mode

arb voltage reduced due to output load or limits

Balance gain limited due to amplitude

Balance offset changed due to amplitude

both edge times decreased due to period

both edge times decreased due to pulse duty cycle

both edge times decreased due to pulse width

BPSK turned off by selection of other mode or modulation

burst count reduced to fit entire burst

Burst mode has caused output phase to be set to zero degrees

burst period increased to fit entire burst

burst phase inapplicable for arbs larger than 1M. burst phase set to 0 (série 33500 uniquement)

burst turned off by selection of other mode or modulation

Cannot combine DC function

cannot delete state selected and enabled for automatic power-on recall

Cannot modulate ARB carrier with ARB as modulation function. Modulation turned off.

Cannot modulate ARB carrier with ARB modulation function. Function unchanged.

Cannot modulate ARB carrier with USER as modulation function. Modulation turned off.

Cannot modulate ARB carrier with USER modulation function. Function unchanged.

Cannot modulate by a two-channel Arb

Cannot modulate Noise carrier with Noise as modulation function. Modulation turned off.

Cannot modulate Noise carrier with Noise modulation function. Function unchanged.

Cannot modulate PRBS carrier with PRBS as modulation function. Modulation turned off.

Cannot modulate PRBS carrier with PRBS modulation function. Function unchanged.

Cannot modulate USER carrier with ARB as modulation function. Modulation turned off.

Cannot modulate USER carrier with ARB modulation function. Function unchanged.

Cannot modulate USER carrier with USER as modulation function. Modulation turned off.

Cannot modulate USER carrier with USER modulation function. Function unchanged.

Cannot select channel as modulating source

Cannot use filter in advance arb trigger mode. (série 33600 uniquement)

combine amplitude exceeds limit. Combine disabled

Combine turned off by selection of DC function

coupling cannot be ON with this function, coupling turned off

coupling violates settings, coupling turned off

edge time decreased due to bit rate

external gating not compatible with gate output; gate output disabled

FM deviation cannot exceed carrier

FM deviation exceeds maximum frequency

FM turned off by selection of other mode or modulation

frequency changed for pulse function

frequency changed for sine function (série 33600 uniquement)

frequency changed for square function (série 33600 uniquement)

frequency forced duty cycle change

frequency made compatible with burst mode (série 33500 uniquement)

frequency reduced for ramp function

frequency reduced for user function

FSK turned off by selection of other mode or modulation

Function or modulation source cannot be USER. Tracking disabled

Function selection limited the FSK frequency.

Gated output not available for gated burst. Output mode changed to normal.

high level changed due to low level

high limit less than low limit. Limits disabled

infinite burst changed trigger source to BUS

input threshold voltage > input range; threshold clipped to range

leading edge time decreased due to period

leading edge time decreased due to pulse width

leading edge times decreased due to pulse duty cycle

limited frequency to 1 MHz when sync mode carrier, burst ON, and function sine (série 33500 uniquement)

list turned off by selection of other mode or modulation

low level changed due to high level

low reference  $\geq$  high reference

marker forced into sweep span

marker off forced sync to normal mode

marker on forced sync to marker mode

marker point changed to fit arb length

modulation frequency made compatible with modulation shape

must stop operation to update trigger count

must stop operation to update trigger delay

not able to adjust phase for arb  $<$  64 samples (série 33600 uniquement)

not able to adjust phase in this function

not able to adjust phase in this mode

not able to burst DC, burst turned off

not able to burst this function

not able to change output load with limits enabled

not able to list arb, list turned off

not able to list DC, list turned off

not able to list noise, list turned off

not able to list PRBS, list turned off

not able to list this function

not able to modulate arb, modulation turned off

not able to modulate DC, modulation turned off

not able to modulate noise, modulation turned off

not able to modulate PRBS, modulation turned off

not able to modulate this function

not able to sweep arb, sweep turned off

not able to sweep DC, sweep turned off

not able to sweep noise, sweep turned off

not able to sweep PRBS, sweep turned off

not able to sweep this function

offset changed due to amplitude

offset changed on exit from DC function

PM turned off by selection of other mode or modulation

prbs edge time increased due to amplitude (série 33600 uniquement)

pulse duty cycle and edge times increased due to amplitude (série 33600 uniquement)

pulse duty cycle decreased due to period

pulse duty cycle increased due to amplitude (série 33600 uniquement)

pulse duty cycle increased due to period

pulse edge times increased due to amplitude (série 33600 uniquement)

pulse width and edge times increased due to amplitude (série 33600 uniquement)

pulse width decreased due to period

pulse width increased due to amplitude (série 33600 uniquement)

pulse width increased due to large period

PWM deviation decreased due to pulse parameters

PWM only available in pulse function

PWM turned off by selection of other mode or modulation

Range hold turned off by selection of new function (série 33600 uniquement)

selected arb is missing, changing selection to default

selecting a sequence turned off modulation

sequences not supported, changing selection to default

signal exceeds high limit. Limits disabled

signal exceeds low limit. Limits disabled

Skew time between channels not available in Burst, Modulation, or Sweep

sum amplitude exceeds limit or range. Sum disabled

SUM turned off by selection of other mode or modulation

Sweep + Hold + Return time larger than trigger TIMER. Trig timer increased.

Sweep + Hold + Return time max (8000s) limited time setting.



- Sweep + Hold + Return time max (8000s) limited time setting.
- Sweep + Hold + Return time too large for IMM or TIMER trigger. Sweep turned off.
- Sweep + Hold + Return time too large for IMM or TIMER trigger. Trig source unchanged.
- Sweep time reduced due to log sweep setting.
- sweep turned off by selection of other mode or modulation
- Tracking turned off by selection of USER function or modulation source
- trailing edge decreased due to leading edge
- trailing edge time decreased due to period
- trailing edge time decreased due to pulse width
- trailing edge times decreased due to pulse duty cycle
- trigger delay reduced to fit entire burst
- trigger output connector used by BPSK
- trigger output connector used by burst gate
- trigger output connector used by FSK
- trigger output connector used by trigger external
- trigger output disabled
- trigger output disabled by trigger external
- Trigger source limited the sweep time; value clipped to upper limit
- triggered burst not available for noise
- turned off infinite burst to allow immediate trigger source
- Use FUNC:ARB to select an ARB before selecting ARB as modulation function. Function unchanged.
- Use FUNC:ARB to select an ARB before selecting ARB as modulation function. Modulation disabled.
- Use FUNC:USER to select a user arb before selecting USER as modulation function. Function unchanged.
- Use FUNC:USER to select a user arb before selecting USER as modulation function. Modulation disabled.
- 213 INIT ignored
- 203 Command protected; Enter calibration password from front panel calibration menu (série 33500 uniquement)
- 203 Command protected; instrument must be unsecured (série 33600 uniquement)
- 203 Command protected; requires license BWD (série 33600 uniquement)

-203 Command protected; requires license SEC (série 33600 uniquement)  
-203 Secure option: Instrument security is unlocked  
-115 Invalid parameter; Parameter not supported on one channel instrument  
-114 Header suffix out of range  
100 Network Error  
110 LXI mDNS Error  
201 Memory lost: stored state  
202 Memory lost: power-on state  
203 Memory lost: stored measurements  
263 Not able to execute while instrument is measuring  
291 Not able to recall state: it is empty  
292 State file size error  
293 State file corrupt  
301 Cannot reset input protection; high voltage present  
305 Not able to perform requested operation  
514 Not allowed  
514 Not allowed; Instrument locked by another I/O session  
521 Communications: input buffer overflow  
522 Communications: output buffer overflow  
532 Not able to achieve requested resolution  
540 Cannot use overload as math reference  
550 Not able to execute command in local mode  
560 No valid external timebase  
561 High voltage present on input channel  
570 DDS Processor is not responding  
580 Reference phase-locked loop is unlocked  
581 Waveform DAC Timing is unlocked (série 33600 uniquement)  
581 Waveform DAC Timing regained lock (série 33600 uniquement)  
582 The DATA controller failed to lock for WFDAC (série 33600 uniquement)  
582 The MU controller failed to lock for WFDAC (série 33600 uniquement)  
582 The SYNC controller failed to lock for WFDAC (série 33600 uniquement)  
600 Internal licensing error

- 601 License file corrupt or empty
- 602 No valid licenses found for this instrument
- 603 Some licenses could not be installed
- 604 License not found
- 605 License already installed

**REMARQUE**

La plupart des codes d'erreur compris entre 600 et 699 se rapportent à des erreurs d'autotest. Pour plus d'informations, reportez-vous à la section [Procédures d'autotest](#).

- 701 Calibration error; security defeated by hardware jumper
- 702 Calibration error; calibration memory is secured
- 703 Calibration error; secure code provided was invalid
- 704 Calibration error: secure code too long
- 705 Calibration error; calibration aborted
- 706 Calibration error; provided value is out of range
- 707 Calibration error: computed correction factor out of range
- 707 Calibration error; signal input is out of range
- 708 Calibration error: signal measurement out of range
- 709 Calibration error: no calibration for this function/range
- 710 Calibration error: full scale correction out of range
- 710 Self-calibration failed
- 711 Calibration error: calibration string too long
- 711 Self-calibration failed
- 712 Calibration failed
- 712 Self-calibration failed
- 715 Self-calibration failed
- 720 Self-calibration failed
- 740 Calibration data lost: secure state
- 741 Calibration data lost: string data
- 742 Calibration data lost: corrections
- 748 Calibration memory write failure
- 770 Nonvolatile arb waveform memory corruption detected
- 781 Not enough memory to store new arb waveform; bad sectors
- 781 Not enough memory to store new arb waveform; use DATA:DELETE

782 Cannot overwrite a built-in arb waveform

784 Name of source arb waveform for copy must be VOLATILE

785 Specified arb waveform does not exist

786 Not able to delete a built-in arb waveform

786 Specified arb waveform already exists

787 Not able to delete the currently selected active arb waveform

787 Specified arb not loaded in waveform memory

788 Could not load specified arb; Loaded Built-in default arb

791 Firmware update error; unable to begin download

792 Firmware update error; programming operation failed

793 Firmware update error; data record invalid character

794 Firmware update error; data record length mismatch

795 Firmware update error; data record checksum mismatch

796 Firmware update error; bad checksum for download start

797 Firmware update error; bad checksum for download complete

798 Firmware update error; download in progress

799 Firmware update error; unable to complete download

800 Firmware update error; invalid programming address

810 State has not been stored

850 Calibration error; set up is invalid

851 Calibration error; set up is out of order

870 Arb: Text File Format error; invalid format

871 Arb: Segment name is too long

872 Arb: File name is too long

873 Arb: Too many sequence steps

874 Arb: Too many segments defined

875 Arb: Too many sequences defined

876 Arb: Sequence already defined

877 Arb: Segment not found

878 Arb: Sequence not found

879 Arb: Segment edit too large

880 Arb: Out of memory

881 Arb: Channel count mismatch

881 Arb: Values are out of range

882 Arb: Segment too small

883 Arb: Error in closing file

884 Arb: Seek too large

885 Arb: Arb file cannot be stored as sequence file

886 Arb: Sequence file cannot be stored as arb file

887 File name error; not a valid extension

888 Arb: Could not create built in arb directory

889 Arb: Could not copy built in arb

890 enable combine forced tracking off

891 enable coupling forced tracking off

892 enable tracking forced coupling off

893 enable tracking forced combine off

894 Enable tracking forced range hold off (série 33600 uniquement)

## Entretien et réparation - Introduction

Cette section contient les informations de base sur l'entretien et la maintenance de votre instrument.

[Types d'interventions et de contrats de maintenance possibles](#)

[Nettoyage](#)

[Précautions contre les décharges électrostatiques \(ESD\)](#)

Autres informations sur la maintenance et l'entretien :

[Schéma fonctionnel - Série 33500](#)

[Schéma fonctionnel - Série 33600](#)

[Alimentations - Série 33500](#)

[Alimentations - Série 33600](#)

[Dépannage - Série 33500](#)

[Dépannage - Série 33600](#)

[Procédures d'autotest](#)

[Pièces détachées](#)

[Démontage - Série 33500](#)

[Démontage - Série 33600](#)

[Remplacement de la batterie](#)

[Installation de l'interface GPIB en option](#)

## Types d'interventions et de contrats de maintenance possibles

Si votre instrument tombe en panne pendant la période de garantie, Keysight Technologies répare ou remplace l'appareil selon les conditions de votre garantie. Après l'expiration de la garantie, Keysight propose des services de réparation économiques.

### Contrats de maintenance longue durée

De nombreux produits Keysight peuvent faire l'objet de contrats de maintenance en option après l'expiration de la garantie.

### Trouver un service de réparation (international)

Pour obtenir une intervention de maintenance pour votre instrument, [contactez votre Centre de maintenance Keysight Technologies](#) qui organisera la maintenance ou le remplacement et vous fournira des informations sur la garantie ou le coût des réparations, le cas échéant. Demandez au Centre de maintenance Keysight Technologies les consignes d'expédition, y compris les composants à envoyer. Nous recommandons de conserver le carton d'emballage pour les expéditions de retour.

## Remballage pour expédition

Pour expédier l'appareil aux fins de maintenance ou de réparation :

- Apposez sur l'appareil une étiquette d'identification du propriétaire et indiquant l'intervention nécessaire (maintenance ou réparation). Incluez les numéros de modèle et de série complets de l'instrument
- Placez l'appareil dans son emballage d'origine avec des matériaux d'emballage adaptés.
- Sécurisez le colis avec des bandes adhésives ou métalliques résistantes.
- Si l'emballage d'origine n'est pas disponible, utilisez un emballage qui laisse un espace d'au moins 10 cm pour le matériau d'emballage compressible autour de l'ensemble de l'instrument. Utilisez des matériaux d'emballage antistatiques.

Keysight recommande d'assurer toujours vos expéditions.

## Nettoyage

Nettoyez l'extérieur de l'instrument avec un chiffon doux non pelucheux et légèrement humide. N'utilisez pas de détergent ni aucune forme de vaporisateur. Le démontage n'est pas nécessaire ni recommandé pour le nettoyage.

## Précautions contre les décharges électrostatiques (ESD)

Pendant les manipulations, des décharges électrostatiques inférieures à 50 V peuvent endommager la plupart des composants électriques.

Les mesures suivantes réduisent les dégâts électrostatiques pendant les interventions de maintenance :

- Démontez les instruments uniquement dans une zone antistatique.
- Utilisez un plan de travail conducteur pour réduire les décharges.
- Utilisez un bracelet antistatique pour réduire les décharges.
- Manipulez l'instrument au minimum.
- Conservez les pièces détachées dans un emballage d'origine antistatique.
- Enlevez de l'environnement immédiat du poste de travail les matières plastiques, la mousse, le vinyle, le papier et les autres matériaux à fort potentiel électrostatique.
- Utilisez uniquement des supports de soudure antistatiques.

## Présentation de l'étalonnage - Série 33500

Ce chapitre décrit les procédures de vérification des performances et des réglages (étalonnage) de l'instrument.

L'instrument utilise une méthode d'étalonnage électronique en boîtier fermé ; aucun réglage mécanique interne n'est nécessaire. L'instrument calcule les facteurs de correction en fonction des valeurs de

référence en entrée que vous configurez et enregistrez ces facteurs en mémoire non volatile jusqu'à l'étalonnage suivant. L'extinction de l'instrument ou l'exécution de la commande \*RST n'entraîne aucune modification de ces données.

## Services d'étalonnage Keysight Technologies

Votre Centre de maintenance Keysight Technologies propose un service de réétalonnage économique. Ce centre utilise des systèmes d'étalonnage automatique qui permettent à Keysight d'assurer ce service à des prix compétitifs.

## Étalonnage - Table des matières

Cette section contient les rubriques suivants :

### Présentation de l'étalonnage

- Intervalle d'étalonnage
- Réglage recommandé
- Temps nécessaire pour l'étalonnage
- Procédures d'étalonnage automatique
- Matériel de test recommandé
- Considérations relatives aux tests
- Nombre de points d'étalonnage
- Message d'étalonnage

### Sécurité de l'étalonnage

### Tests de vérification des performances

- Autotest
- Vérification rapide des performances
- Tests de vérification des performances
- Procédures de vérification de l'amplitude et de la planéité

### Vérification de la base de temps interne

### Vérification de l'amplitude CA (haute impédance)

### Vérification de la tension CC résiduelle

### Vérification de la planéité dans la plage -8 dB

### Vérification de la planéité dans la plage -24 dB

### Procédure générale d'étalonnage/réglage

### Abandon d'un étalonnage en cours



## Entretien et réparation - Introduction

### Ordre des réglages

#### Autotest

Réglage de la fréquence (base de temps interne)

Réglage du convertisseur analogique/numérique (ADC) interne

Réglage de l'auto-étalonnage

Réglage de l'impédance de sortie

Réglage de l'amplitude CA (haute impédance)

Réglage de la planéité dans la plage -24 dB

Réglage de la planéité dans la plage -8 dB

Réglage de la voie 2 (le cas échéant)

- Réglage de l'auto-étalonnage (voie 2)
- Réglage de l'impédance de sortie (voie 2)
- Réglage de l'amplitude CA (haute impédance) (voie 2)
- Réglage de la planéité dans la plage -24 dB (voie 2)
- Réglage de la planéité dans la plage -8 dB (voie 2)

### Erreurs d'étalonnage

### Rubrique d'étalonnage suivante

## Présentation de l'étalonnage - Série 33500

Cette section présente les fonctions d'étalonnage de l'instrument. Pour des informations détaillées sur l'étalonnage, reportez-vous à la section [Présentation de l'étalonnage](#).

### Intervalle d'étalonnage

L'instrument doit être étalonné régulièrement à une fréquence qui dépend de la précision nécessaire à votre application. Un intervalle d'un an convient à la plupart des applications. Les spécifications de précision sont garanties uniquement si l'étalonnage est effectué régulièrement. Au-delà d'un an, elles ne sont plus garanties. Keysight Technologies recommande de ne pas laisser passer plus de 2 ans entre deux étalonnages, quelle que soit l'application.

### Réglage recommandé

Quelle que soit la fréquence d'étalonnage choisie, Keysight Technologies recommande de procéder à un réétalonnage complet au terme de cette durée. De cette manière, l'instrument conserve ses caractéristiques jusqu'à l'étalonnage suivant et offre une meilleure stabilité à long terme. Les caractéristiques fonctionnelles mesurées avec cette méthode peuvent être utilisées pour prolonger la fréquence

d'étalonnage. Utilisez le nombre de points d'étalonnage pour vérifier que tous les réglages ont été effectués.

### Temps nécessaire pour l'étalonnage

Pour la vérification d'un instrument reçu, effectuez d'abord les tests de vérification des performances. Effectuez ensuite les réglages et exécutez à nouveau les tests de fonctionnement. Si elle est effectuée manuellement, chaque opération dure environ 30 minutes par voie.

Vous pouvez également étalonner automatiquement l'instrument à l'aide d'un ordinateur. Avec un ordinateur, la procédure complète d'étalonnage et les tests de vérification des performances durent environ 30 minutes (une voie) ou 60 minutes (deux fois) lorsque l'instrument est préchauffé (voir **Considérations relatives aux tests**).

### Procédures d'étalonnage automatique

Vous pouvez utiliser un équipement de test programmable pour automatiser les procédures de vérification et de réglage. Vous pouvez programmer la configuration de chaque test de l'instrument sur l'interface distante. Entrez ensuite les données vérifiées dans un programme de test et comparez les résultats à la limite de test correspondante.

Vous pouvez également régler l'instrument à partir de l'interface distante ; cette procédure est similaire à celle qui est utilisée sur la face avant. Utilisez un ordinateur pour effectuer le réglage ; sélectionnez d'abord la fonction et la plage désirées sur l'équipement de mesure. Envoyez la valeur d'étalonnage à l'instrument et démarrez l'étalonnage sur l'interface distante.

Vous devez **déverrouiller la sécurité de l'instrument** avant l'étalonnage.

Séquence de programmation type pour une configuration d'étalonnage :

1. **CAL:SETup 2** (configurer l'instrument pour l'opération d'étalonnage n°2)
2. Mesurer la fréquence de sortie avec le fréquencemètre externe
3. **CAL:VALue 9.99994321E6** (envoyer la valeur mesurée à l'instrument)
4. **CAL?** (démarre l'étalonnage pour la configuration n°2)
5. Lire la valeur de la requête **CAL?** pour déterminer l'échec (+1) ou la réussite (+0) du réglage
6. **CAL:SETup 3** (configure l'instrument pour l'opération d'étalonnage n°3)

Pour plus d'informations sur la programmation de l'instrument, reportez-vous à la section **Présentation du langage SCPI**.

### Matériel de test recommandé

L'équipement nécessaire aux tests de performances et aux procédures de réglage est répertorié ci-dessous. Si l'instrument recommandé est indisponible, vous pouvez le remplacer par un autre de précision équivalente.

Instrument	Conditions requises	Modèle recommandé	Utilisation *
Multimètre numérique (DMM)	Vca, valeurs efficaces, précision du couplage CA : $\pm 0,02\%$ à 1 MHz Précision Vcc : Résolution 50 ppm : Précision de la résistance sous 100 $\mu\text{V}$ avec compensation de la tension résiduelle : $\pm 0,1\ \Omega$	Keysight 3458A	Q, P, T
Voltmètre CA de précision	1 000 Hz à 30 MHz , précision entre 0,1 Veff et 2 Veff (-7 dBm et +20 dBm) : résolution 0,02 dB : 0,01 dB	Fluke 5790A	Q, P, T
Fréquencemètre	précision : 0,1 ppm	Keysight 53132A Opt 012 (stabilité élevée)	Q, P, T
Oscilloscope	Impédance d'entrée 1 GHz 4 Gs/seconde 50 $\Omega$	Keysight MSO6104A	T
Adaptateur	Type N (m) sur BNC (m)	Keysight E9623A	Q, P, T
Câble (2 requis)	Double fiche banane (m) sur double fiche banane (m)	Keysight 11000-60000	Q, P, T
Câble	RG58, BNC (m) sur double fiche banane OU Câble coaxial RG58 avec BNC (m) sur double adaptateur banane	Keysight 11001-60001	Q, P, T
Câble	RG58, BNC (m) sur BNC (m)	Keysight 11170C	Q, P, T

\* Q = vérification rapide P = vérification des performances T = dépannage

### Considérations relatives aux tests

Pour des résultats optimaux, respectez les recommandations suivantes pour toutes les procédures :

- Température ambiante stable pour l'étalonnage (de 18 à 28 °C). La température idéale est  $23 \pm 1\ ^\circ\text{C}$ .
- Humidité relative inférieure à 80 %.
- Chauffage d'une heure avant la vérification ou le réglage.
- Câbles de mesure les plus courts possibles et adaptés à l'impédance.
- Câble RG-58 ou 50  $\Omega$  équivalent.

### Nombre de points d'étalonnage

Vous pouvez interroger l'instrument afin de déterminer le nombre de points d'étalonnage effectués. L'instrument a été étalonné en usine. À la réception de l'instrument, lisez le nombre de points d'étalonnage pour déterminer sa valeur initiale.

- Ce paramètre est non volatile ; il n'est pas modifié par une remise sous tension ou l'exécution de la commande **\*RST**.

- Du fait que le nombre de points augmente d'une unité pour chaque point étalonné qui enregistre une valeur, un étalonnage complet augmente ce nombre considérablement.



- Face avant :
- SCPI : **CAL:COUNT?**

### Message d'étalonnage

Vous pouvez enregistrer un message contenant jusqu'à 40 caractères dans la mémoire d'étalonnage. Par exemple, vous pouvez enregistrer la date du dernier étalonnage, celle à laquelle doit être effectué le prochain étalonnage, le numéro de série de l'instrument ou les coordonnées des techniciens d'étalonnage.

Déverrouillez la sécurité de l'instrument pour enregistrer un message d'étalonnage. Vous pouvez lire le message d'étalonnage sur la face avant ou l'interface distante, que l'instrument soit ou non verrouillé.

- L'enregistrement d'un message d'étalonnage entraîne le remplacement de tout message précédemment enregistré.
- Ce paramètre est non volatile ; il n'est pas modifié par une remise sous tension ou l'exécution de la commande **\*RST**.



- Face avant :
- SCPI : **CAL:STR "Cal Due: 01 August 2012"**

[Rubrique d'étalonnage précédente](#)   [Rubrique d'étalonnage suivante](#)

### Sécurité de l'étalonnage - Série 33500

Cette section décrit le système de sécurité de l'étalonnage de l'instrument.

#### Présentation de la sécurité

Un code de sécurité empêche les réglages accidentels ou non autorisés de l'instrument. Sur la série 33500, le code de sécurité par défaut configuré en usine varie selon le modèle :

Models	Code de sécurité
33521A et 33522A	AT33520A
335XXB	AT33500

- Une fois que vous avez saisi un code de sécurité, vous devez l'utiliser pour les opérations sur la face avant et l'interface distante. Si vous verrouillez l'instrument sur la face avant, vous devez utiliser ce même code pour le déverrouiller à partir de l'interface distante.
- Ce paramètre est non volatile ; il n'est pas modifié par une remise sous tension ou l'exécution de la commande **\*RST**.
- Règles applicables aux codes de sécurité :
  - Chaîne de 12 caractères maximum sans guillemets
  - Doit commencer par une lettre (A-Z)
  - Peut contenir des lettres, des chiffres (0 à 9) et le caractère de soulignement
- **Face avant :**



- **SCPI : CALibration\_SECURITY:STATe**

#### Déverrouillage de l'instrument sans code de sécurité

**ATTENTION** Avant de démarrer cette procédure, reportez-vous à la section **Précautions contre les décharges électrostatiques (ESD)**.

1. Débranchez le cordon d'alimentation, ainsi que toutes les connexions d'entrée et de sortie.
2. Démontez l'instrument (voir la section **Démontage - Série 33500**).

- Appliquez un court-circuit momentané entre les broches 1 et 6 du connecteur de la carte principale, illustré ci-dessous.

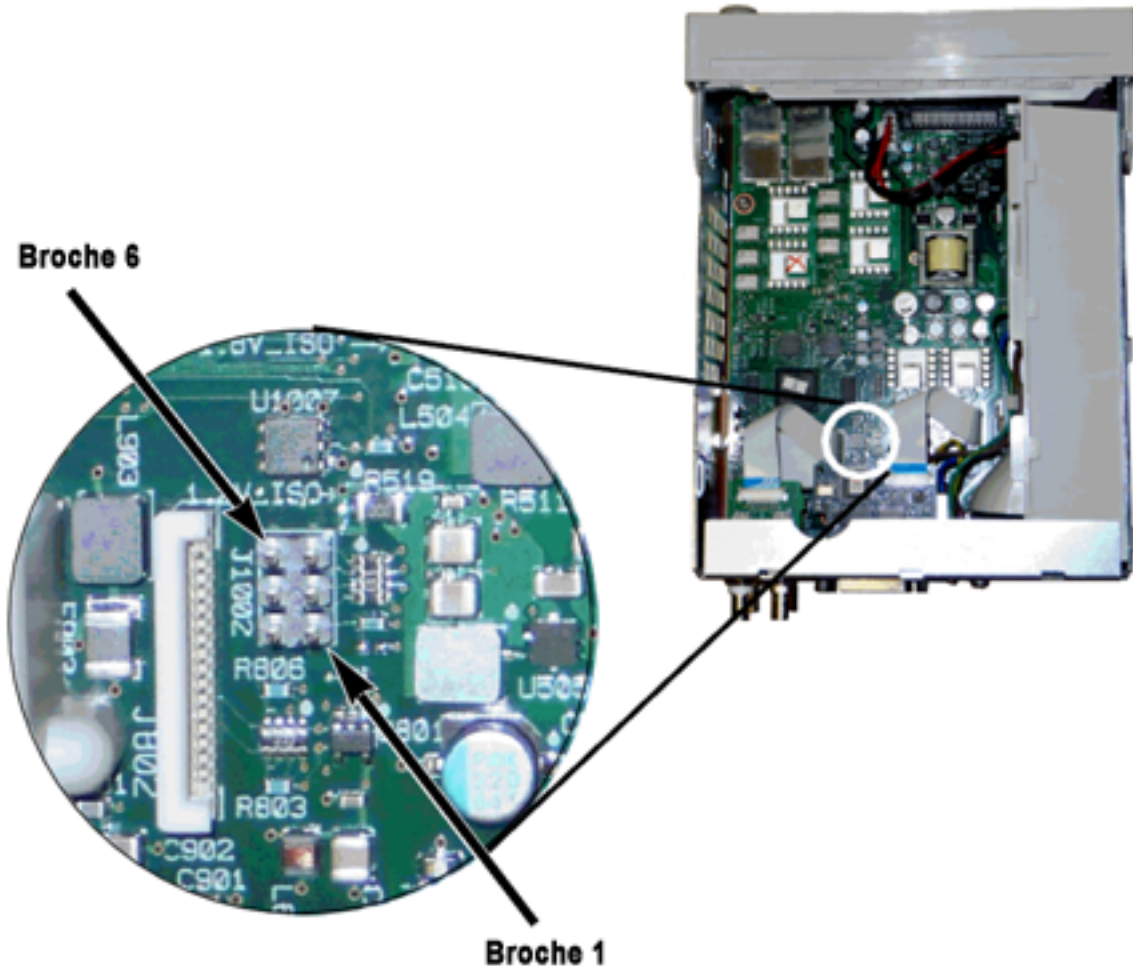

- Branchez le cordon d'alimentation et mettez l'instrument sous tension.

**AVERTISSEMENT**

Veillez à ne pas toucher les connexions de l'alimentation ou les hautes tensions présentes sur le module d'alimentation. La tension d'alimentation est présente, même si l'instrument est éteint.

- La file des messages d'erreur affiche le message « Calibration security has been disabled ».

La sécurité de l'étalonnage est déverrouillée ; le mot de passe est alors rétabli à sa valeur par défaut configurée en usine. Le nombre de points d'étalonnage augmente d'une unité, car le cavalier était connecté pendant la mise sous tension ; le message d'erreur **+701, "Calibration error; security defeated by hardware jumper"** s'affiche. L'enregistrement de l'étalonnage en mémoire non volatile est mis à jour pour tenir compte de ces opérations.

- Éteignez l'instrument, enlevez le cavalier de court-circuit et le cordon d'alimentation.
- Remontez l'instrument.
- Entrez un nouveau code de sécurité (voir ci-dessus) et conservez ce code dans un endroit sûr.

[Rubrique d'étalonnage précédente](#) [Rubrique d'étalonnage suivante](#)

## Vérification - Série 33500

Les rubriques suivantes décrivent la partie de vérification de la procédure d'étalonnage :

- [Tests de vérification des performances](#)
- [Vérification de la base de temps interne](#)
- [Vérification de l'amplitude CA \(haute impédance\)](#)
- [Vérification de la tension CC résiduelle](#)
- [Vérification de la planéité dans la plage -8 dB](#)
- [Vérification de la planéité dans la plage -24 dB](#)

[Rubrique d'étalonnage précédente](#) [Rubrique d'étalonnage suivante](#)

## Tests de vérification des performances - Série 33500

Ces tests permettent de vérifier les performances de mesure de l'instrument. Ils reposent sur les spécifications de l'instrument figurant dans la fiche technique du produit.

Il existe trois niveaux de tests de vérification des performances :

- **Autotest** Ensemble de tests de vérification internes qui permettent de s'assurer que l'instrument fonctionne correctement.
- **Vérification rapide** Combinaison des autotests internes et des tests de vérification sélectionnés.
- **Tests de vérification des performances** Ensemble complet de tests recommandés comme test de recette à la réception de l'instrument ou après avoir effectué des réglages.

### Autotest

Un bref autotest de mise sous tension est effectué automatiquement à chaque mise sous tension de l'instrument. Il certifie que l'instrument est opérationnel. Pour plus d'informations, reportez-vous à la section [Procédures d'autotest](#).

### Vérification rapide des performances

La vérification rapide des performances regroupe l'autotest et un test de performances réduit (spécifié par la lettre Q dans les tests de vérification des performances). Ce test constitue une méthode simple de vérification du fonctionnement de l'instrument et de respect des spécifications. Ces tests représentent l'ensemble minimal de vérifications des performances recommandées après une intervention de maintenance. Le contrôle des performances de l'instrument pour les points de contrôle rapide (désignés par Q) vérifie le fonctionnement des mécanismes normaux de dérive de la précision. Ce test ne vérifie pas les défauts anormaux des composants.

Pour effectuer une vérification rapide des performances, procédez comme suit :

1. Effectuez un **autotest complet**.
2. Effectuez uniquement les tests de vérification des performances indiqués par la lettre Q.
3. Si l'instrument échoue au contrôle rapide du fonctionnement, un réglage ou une réparation s'avèrent nécessaires.

### Tests de vérification des performances

Les tests de vérification des performances sont recommandés comme tests de recette technique lorsque vous recevez initialement l'instrument. Les résultats des tests de recette doivent être comparés aux spécifications figurant dans la fiche technique du produit. Par la suite, vous devrez répéter les tests de vérification des performances à chaque intervalle d'étalonnage.

Si l'instrument échoue aux tests de vérification du fonctionnement, un réglage ou une réparation s'avèrent nécessaires.

Un réglage est recommandé à chaque intervalle d'étalonnage. Si aucun réglage n'est effectué, vous devez protéger la bande, sans aller au-delà de 80 % des spécifications répertoriées dans la fiche technique, que vous utiliserez comme limites de vérification.

### Procédures de vérification de l'amplitude et de la planéité

Les procédures de vérification de la planéité utilisent un voltmètre CA de précision et un wattmètre. Vous pouvez remplacer les convertisseurs de tension thermiques (TVC) pour effectuer des mesures par des procédures opérationnelles et un équipement de test appropriés.

Les mesures de planéité dans les plages -24 dB et -8 dB de l'atténuateur sont effectuées pendant la procédure de vérification. D'autres plages de l'atténuateur sont vérifiées dans le cadre des procédures de vérification de la plage d'atténuation -24 dB et -8 dB. Il n'existe aucune procédure de vérification distincte pour ces plages.

[Rubrique d'étalonnage précédente](#)   [Rubrique d'étalonnage suivante](#)

### Vérification de la base de temps interne - Série 33500

Vérifie la précision de la fréquence de sortie. Toutes les fréquences de sortie sont dérivées d'une fréquence générée.

1. Connectez un fréquencemètre à la sortie de la voie 1, comme indiqué ci-dessous (l'entrée du fréquencemètre doit être terminée à 50  $\Omega$ ).



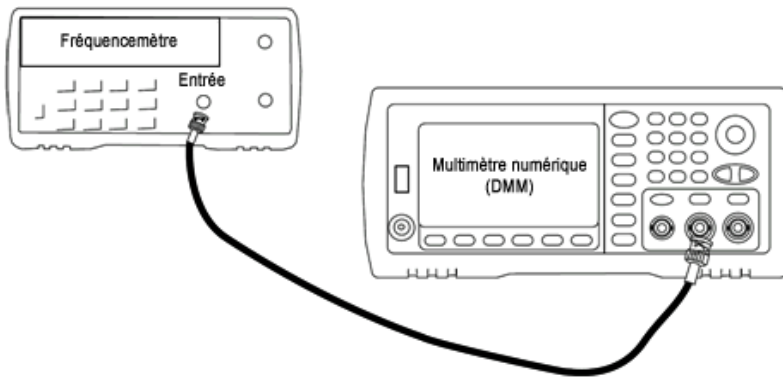

- Configurez l'instrument sur la sortie décrite dans le tableau ci-dessous et mesurez la fréquence de sortie. Vérifiez que la sortie de l'instrument est active.

Utiliser	Générateur de signaux			Mesure	
	Fonction	Amplitude	Fréquence	Nominal	Erreur*
Q	Sinusoidal	1,00 Vpp	10,0000000 MHz	10,000 MHz	±10 Hz

\* Avec la **base de temps OCXO haute stabilité en option**, l'erreur de mesure est égale à ±1 Hz.

- Comparez la valeur mesurée aux limites de test indiquées dans le tableau.

[Rubrique d'étalonnage précédente](#)   [Rubrique d'étalonnage suivante](#)

### Vérification de l'amplitude CA (haute impédance) - Série 33500

Vérifie la précision de l'amplitude CA à la fréquence de 1 kHz en utilisant chaque atténuateur.

- Réglez le multimètre numérique pour mesurer les tensions efficaces. Connectez le multimètre numérique à la sortie de la voie, comme indiqué ci-dessous.

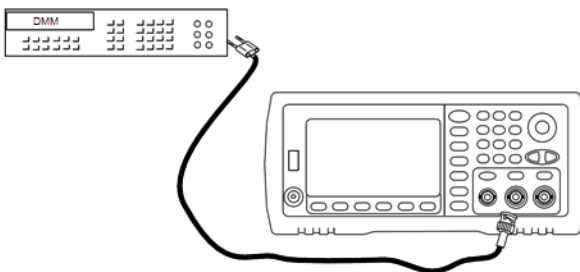

- Configurez l'instrument sur chaque sortie indiquée dans le tableau ci-dessous et mesurez la tension de sortie à l'aide du multimètre numérique. Vérifiez que l'impédance de sortie est définie sur High-Z (Haute impédance) et que la sortie est activée.

Utiliser	Générateur de signaux				Mesure	
	Configuration de la sortie	Fonction	Fréquence	Amplitude	Nominal	Erreur*

Utiliser	Générateur de signaux				Mesure	
Q	Haute impédance (High Z) **	Sinusoïdal	1,000 kHz	400,0 mVeff	400,0 mVeff	±0,004707 Veff
Q	High Z	Sinusoïdal	1,000 kHz	400,0 mVeff	400,0 mVeff	±0,004707 Veff
Q	High Z	Sinusoïdal	1,000 kHz	1,00 Veff	1,00 Veff	±0,010707 Veff
Q	High Z	Sinusoïdal	1,000 kHz	2,500 Veff	2,500 Veff	±0,025707 Veff
Q	High Z	Sinusoïdal	1,000 kHz	7,000 Veff	7,000 Veff	±0,070707 Veff

\* Sur la base de 1 % du réglage de  $\pm 1$  mVpp (50  $\Omega$ ) ; convertie en Veff pour une haute impédance.

\*\* Pour configurer cette sortie, procédez comme suit :

- a. Réglez l'amplitude sur 400,0 mVeff
  - b. Définissez la tension CC résiduelle à 1,0 Vcc
  - c. Désactivez l'échelle automatique (OFF)
  - d. Réglez la tension CC résiduelle sur 0,0 Vcc
  - e. Une fois la mesure effectuée, activez l'échelle automatique (ON) pour les autres mesures.
3. Comparez la valeur mesurée aux limites de test indiquées dans le tableau.
  4. Instruments 2 voies uniquement : connectez le multimètre numérique à la sortie de la voie 2 et répétez les opérations 2 et 3.

[Rubrique d'étalonnage précédente](#) [Rubrique d'étalonnage suivante](#)

### Vérification de la tension CC résiduelle - Série 33500

Vérifie la tension CC résiduelle sur deux plages de l'atténuateur :

1. Réglez le multimètre numérique pour mesurer des tensions continues. Connectez le multimètre numérique à la sortie de la voie, comme indiqué ci-dessous.

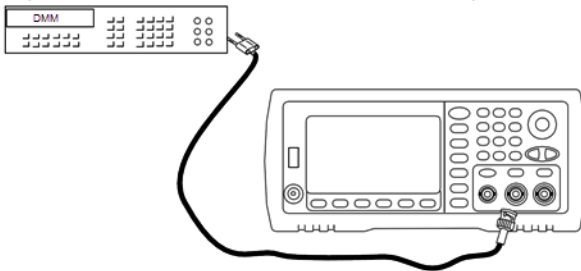

- Configurez l'instrument sur chaque sortie indiquée dans le tableau ci-dessous et mesurez la tension de sortie à l'aide du multimètre numérique.

Utiliser	Générateur de signaux			Mesure	
	Configuration de la sortie	Fonction	Tension	Nominal	Erreur*
Q	High Z	CC	0,0 V	0,0 Vcc	±0,002 Vcc
Q	High Z	CC	500 mV	0,500 Vcc	±0,007 Vcc
Q	High Z	CC	10,0 V	10,0 Vcc	±0,102 Vcc

\* Sur la base de 1 % du réglage ±2 mVcc pour une haute impédance.

- Comparez la valeur mesurée aux limites de test indiquées dans le tableau.
- Instruments 2 voies uniquement : connectez le multimètre numérique à la sortie de la voie 2 et répétez les opérations 2 et 3.

[Rubrique d'étalonnage précédente](#) [Rubrique d'étalonnage suivante](#)

### Vérification de la planéité dans la plage -8 dB - Série 33500

Vérifiez la planéité de l'amplitude CA haute fréquence dans la plage -8 dB de l'atténuateur. Vérifiez également la planéité de toutes les autres plages, à l'exclusion des plages -24 dB et 0 dB de l'atténuateur.

- Connectez un voltmètre CA de précision pour mesurer l'amplitude de sortie, comme indiqué ci-dessous. Connectez le câble BNC à l'entrée large bande de l'instrument Fluke 5790A. Si vous utilisez un matériel de test de remplacement, vérifiez que l'impédance d'entrée est égale à 50 Ω, car la précision de la charge affecte directement la qualité des mesures.

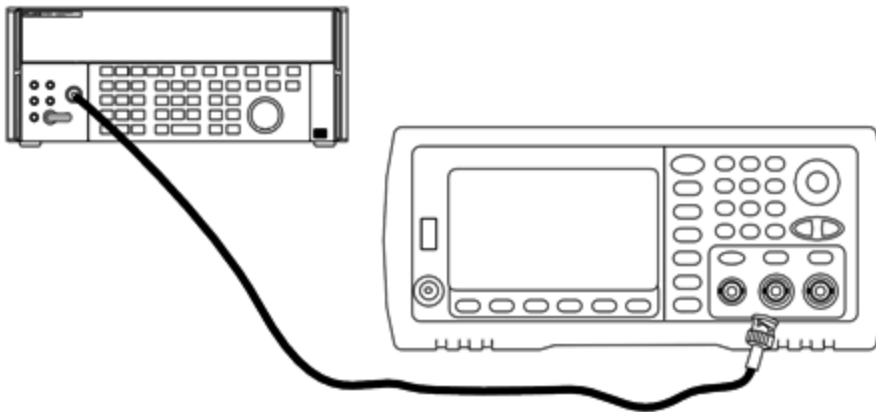

- Réglez le voltmètre CA de précision sur « Intermédiaire, Intermédiaire » Filtre numérique et Redémarrage filtre.
- Configurez l'instrument sur chaque sortie décrite dans le tableau ci-dessous et mesurez l'amplitude de sortie à l'aide du voltmètre CA. Cette mesure devient la mesure de référence. Réglez l'impédance de sortie sur 50 Ω et vérifiez que la sortie est activée.

Utiliser	Générateur de signaux				Mesure	
	Charge de sortie	Fonction	Amplitude	Fréquence	Nominal	Erreur
Q	50 $\Omega$	Sinusoïdal	1,200 Veff	1,000 kHz	1,200 Veff	$\pm 0,0127$ Veff

- Configurez la valeur mesurée à l'étape 3 afin qu'elle soit la valeur de référence sur le voltmètre CA.
- Configurez l'instrument sur chaque sortie décrite dans le tableau ci-dessous et mesurez l'amplitude en pourcentage par rapport à la source à l'aide du voltmètre CA. Notez que le tableau indique également la sortie en dB si vous utilisez un wattmètre pour effectuer ce test.

Utiliser	Générateur de signaux				Mesure			
	Charge de sortie	Fonction	Amplitude	Fréquence	Nominal	Erreur	Nominal	Erreur
	50 $\Omega$	Sinusoïdal	1,200 Veff	100,000 kHz	100 %	$\pm 1,15$ %	0 dB	$\pm 0,10$ dB
				500,000 kHz		$\pm 1,74$ %		$\pm 0,15$ dB
				1,000 MHz		$\pm 1,74$ %		$\pm 0,15$ dB
Q	50 $\Omega$	Sinusoïdal	1,200 Veff	2,000 MHz	100 %	$\pm 1,74$ %	0 dB	$\pm 0,15$ dB
	50 $\Omega$	Sinusoïdal	1,200 Veff	5,000 MHz	100 %	$\pm 1,74$ %	0 dB	$\pm 0,15$ dB
				10,00 MHz		$\pm 3,51$ %		$\pm 0,30$ dB
				15,00 MHz		$\pm 3,51$ %		$\pm 0,30$ dB
				20,00 MHz		$\pm 3,51$ %		$\pm 0,30$ dB
				22,00 MHz (non requis pour les instruments 20 MHz)		$\pm 4,71$ %		$\pm 0,40$ dB
				27,00 MHz (non requis pour les instruments 20 MHz)		$\pm 4,71$ %		$\pm 0,40$ dB
				30,00 MHz (non requis pour les instruments 20 MHz)		$\pm 4,71$ %		$\pm 0,40$ dB

- Comparez la valeur mesurée aux limites de test indiquées dans le tableau.

7. Instruments 2 voies uniquement : Connectez le voltmètre CA à la voie 2 et répétez les opérations 2 à 6.

[Rubrique d'étalonnage précédente](#) [Rubrique d'étalonnage suivante](#)

### Vérification de la planéité dans la plage -24 dB - Série 33500

Vérifiez la planéité de l'amplitude CA haute fréquence dans la plage -24 dB de l'atténuateur. Vérifiez également la planéité sur la plage 0 dB de l'atténuateur.

1. Connectez un voltmètre CA de précision pour mesurer l'amplitude de sortie, comme indiqué ci-dessous. Connectez le câble BNC à l'entrée large bande de l'instrument Fluke 5790A. Si vous utilisez un matériel de test de remplacement, vérifiez que l'impédance d'entrée est égale à 50 Ω, car la précision de la charge affecte directement la qualité des mesures.

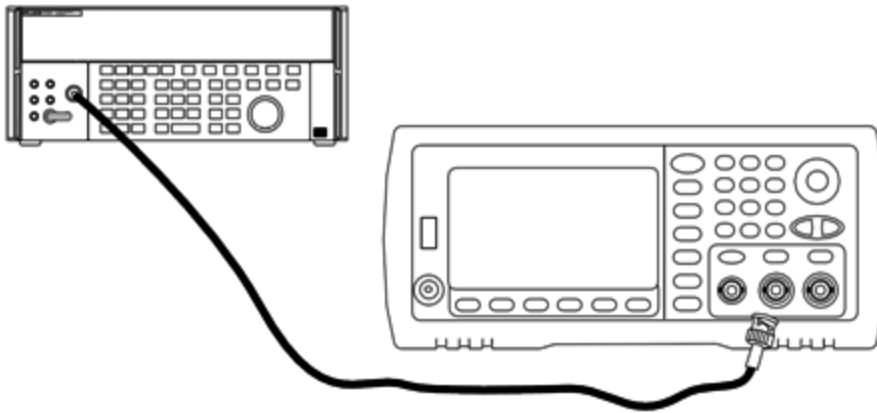

2. Réglez le voltmètre CA de précision sur « Intermédiaire, Intermédiaire » Filtre numérique et Redémarrage filtre.
3. Configurez l'instrument sur chaque sortie décrite dans le tableau ci-dessous et mesurez l'amplitude de sortie à l'aide du voltmètre CA. Cette mesure devient la mesure de référence. Réglez l'impédance de sortie sur 50 Ω et vérifiez que la sortie est activée.

Utiliser	Générateur de signaux				Mesure	
	Charge de sortie	Fonction	Amplitude	Fréquence	Nominal	Erreur
Q	50 Ω	Sinusoïdal	0,190 Veff	1,000 kHz	0,190 Veff	±0,0026 Veff

4. Configurez la valeur mesurée à l'étape 3 afin qu'elle soit la valeur de référence sur le voltmètre CA.
5. Configurez l'instrument sur chaque sortie décrite dans le tableau ci-dessous et mesurez l'amplitude en pourcentage par rapport à la source à l'aide du voltmètre CA. Notez que le tableau indique également la sortie en dB si vous utilisez un wattmètre pour effectuer ce test.

Utiliser	Générateur de signaux				Mesure			
	Charge de sortie	Fonction	Amplitude	Fréquence	Nominal	Erreur	Nominal	Erreur
	50 $\Omega$	Sinusoïdal	0,190 V <sub>eff</sub>	100,000 kHz	100 %	±1,15 %	0 dB	±0,10 dB
				500,000 kHz		±1,74 %		±0,15 dB
				1,000 MHz		±1,74 %		±0,15 dB
Q	50 $\Omega$	Sinusoïdal	0,190 V <sub>eff</sub>	2,000 MHz	100 %	±1,74 %	0 dB	±0,15 dB
	50 $\Omega$	Sinusoïdal	0,190 V <sub>eff</sub>	5,000 MHz	100 %	±1,74 %	0 dB	±0,15 dB
				10,00 MHz		±3,51 %		±0,30 dB
				15,00 MHz		±3,51 %		±0,30 dB
				20,00 MHz		±3,51 %		±0,30 dB
				22,00 MHz (non requis pour les instruments 20 MHz)		±4,71 %		±0,40 dB
				27,00 MHz (non requis pour les instruments 20 MHz)		±4,71 %		±0,40 dB
				30,00 MHz (non requis pour les instruments 20 MHz)		±4,71 %		±0,40 dB

6. Comparez la valeur mesurée aux limites de test indiquées dans le tableau.
7. Instruments 2 voies uniquement : Connectez le voltmètre CA à la voie 2 et répétez les opérations 2 à 6.

[Rubrique d'étalonnage précédente](#) [Rubrique d'étalonnage suivante](#)

### Procédure générale d'étalonnage/réglage - Série 33500

Méthode recommandée pour l'étalonnage complet de l'instrument :

1. Consultez la section **Considérations relatives aux tests**.
2. **Effectuez les tests de vérification** pour caractériser l'instrument (données entrantes).
3. Appuyez sur [**System > Instr Setup > Calibrate**]. Si la sécurité de l'instrument pour l'étalonnage est verrouillée, **déverrouillez-la**.
4. Entrez le numéro du réglage de la procédure en cours. Le numéro par défaut est « 1 » ; sur la face avant, ce numéro est incrémenté à mesure que les procédures sont exécutées.
5. Sélectionnez **BEGIN**.
6. Pour les réglages qui nécessitent une entrée, réglez la valeur affichée avec la valeur mesurée et sélectionnez **ENTER VALUE**.
7. La configuration passe automatiquement à la valeur suivante nécessaire.

Pour annuler la procédure de réglage, sélectionnez **CANCEL STEP**. L'écran revient à la saisie du numéro de réglage.

8. Lorsque vous avez terminé, sélectionnez **END CAL**.
9. (Option) Configurez un nouveau message d'étalonnage via l'interface distante. Ce message (contenant jusqu'à 40 caractères) est enregistré avec les coefficients d'étalonnage.
10. Verrouillez la sécurité d'étalonnage du multimètre.
11. Notez le nouveau code de sécurité et le nombre de points d'étalonnage figurant dans les dossiers de maintenance de l'instrument.

[Rubrique d'étalonnage précédente](#)   [Rubrique d'étalonnage suivante](#)

## Abandon d'un étalonnage en cours - Série 33500

Il est parfois nécessaire d'abandonner un étalonnage en cours. Vous pouvez abandonner un étalonnage à tout moment : mettez l'instrument hors tension ou, sur l'interface distante, envoyez un message d'effacement de l'appareil suivi de la commande **\*RST**.

L'instrument enregistre les constantes d'étalonnage à la fin de chaque procédure d'étalonnage. Si l'alimentation est coupée ou si un réglage en cours est abandonné pour une raison quelconque, il suffit d'exécuter à nouveau la procédure de réglage interrompue.

### ATTENTION

Si l'alimentation est coupée lorsque l'instrument écrit en mémoire de nouvelles constantes d'étalonnage, vous pouvez perdre toutes les constantes d'étalonnage de la fonction. Généralement, lorsque vous remettez l'instrument sous tension, celui-ci génère l'erreur **"-313, Calibration Memory Lost"**.

[Rubrique d'étalonnage précédente](#)   [Rubrique d'étalonnage suivante](#)

## Ordre des réglages - Série 33500

L'ordre des réglages dans les opérations numérotées minimise le nombre de réglages du matériel de test et de modifications des connexions.

Vous pouvez effectuer des réglages séparés si nécessaire, mais les opérations 1 à 7 doivent être exécutées dans cet ordre avant toute autre procédure de réglage.

[Rubrique d'étalonnage précédente](#) [Rubrique d'étalonnage suivante](#)

### Autotest - Série 33500

Exécutez l'autotest pour vous assurer que l'instrument fonctionne correctement avant d'effectuer tout autre réglage.

Assurez-vous de déverrouiller l'instrument et de respecter les consignes figurant à la section [Considérations relatives aux tests](#) avant de commencer un réglage.

1. Appuyez sur **[System > Instr Setup > Calibrate]**. Entrez le numéro de réglage 1 et sélectionnez **BEGIN**.

Réglage	
1	Exécutez l'autotest. La sortie principale est désactivée pendant le test.

2. Si l'instrument échoue à l'autotest, vous devez le réparer avant de poursuivre les procédures de réglage.

Un autotest complet (**\*TST?**) dure environ 15 secondes.

[Rubrique d'étalonnage précédente](#) [Rubrique d'étalonnage suivante](#)

### Réglage de la fréquence (base de temps interne) - Série 33500

L'instrument enregistre une constante d'étalonnage qui règle l'oscillateur à quartz sur la fréquence exacte de 10 MHz. L'instrument doit avoir fonctionné en permanence pendant 30 minutes avant cet étalonnage afin de garantir la stabilité de la base de temps.

1. Configurez la résolution du fréquencemètre à moins de 0,01 ppm et la terminaison d'entrée à 50  $\Omega$  (si votre fréquencemètre n'est pas équipé d'une terminaison d'entrée de 50  $\Omega$ , vous devez fournir une terminaison externe). Effectuez les connexions indiquées ci-dessous.



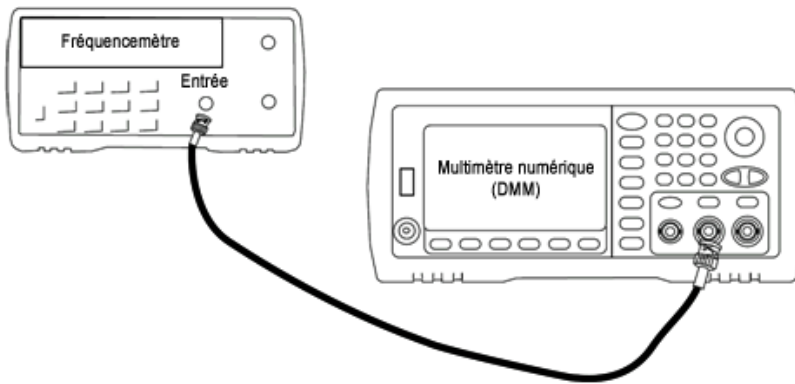

2. Utilisez le fréquencemètre pour mesurer la fréquence de sortie de chaque réglage figurant dans le tableau suivant.

Réglage	Signal nominal		
	Fréquence	Amplitude	
2	<10 MHz	~1 Vpp	La fréquence de sortie est légèrement inférieure à 10 MHz
3	>10 MHz		La fréquence de sortie est légèrement supérieure à 10 MHz
4	~10 MHz		La fréquence de sortie doit être proche de 10 MHz
5*	10 MHz		La fréquence de sortie doit être de 10 MHz ± 1 ppm

\* Les constantes sont enregistrées après cette configuration.

3. À l'aide du clavier numérique ou du bouton, réglez la fréquence affichée pour chaque réglage sur la fréquence mesurée. Sélectionnez **ENTER VALUE**.
4. Ensuite :
  - a. Si vos procédures d'étalonnage requièrent la vérification du réglage qui vient d'être effectué, quittez le menu d'étalonnage et procédez à la **Vérification de la base de temps interne**.
  - b. Si vous effectuez tous les réglages sur un instrument 2 voies et vérifiez ensuite le fonctionnement de l'instrument, passez à la procédure suivante de cette section.

[Rubrique d'étalonnage précédente](#)   [Rubrique d'étalonnage suivante](#)

## Réglage du convertisseur analogique/numérique (ADC) interne - Série 33500

L'instrument enregistre les constantes d'étalonnage pour le gain et la tension résiduelle du convertisseur analogique/numérique interne. L'opération 6 doit toujours être exécutée avant tout autre réglage de l'amplitude. Le convertisseur analogique/numérique interne est alors utilisé comme source pour les constantes d'étalonnage générées lors de l'auto-étalonnage (opération 7).

1. Branchez la sortie de la voie 1 aux connecteurs Modulation Input et DMM de la face arrière, comme indiqué ci-dessous.

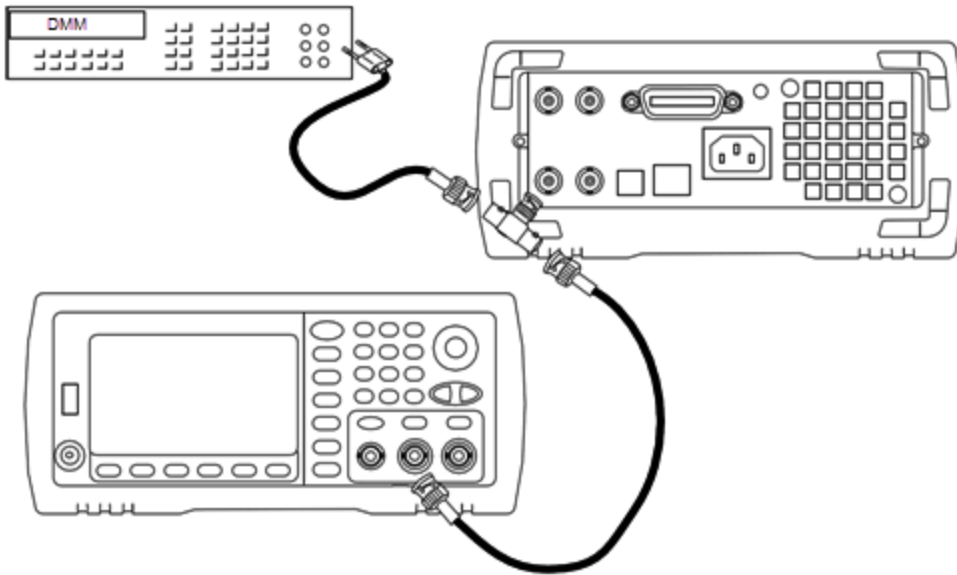

2. Réglez le voltmètre numérique pour afficher 5 chiffres et demi et mesurer les tensions continues (Vcc).
3. Entrez le réglage suivant.

	Signal nominal	
Réglage	Niveau CC	
6*	$\sim 1,0 V_{cc} \pm 10 \%$	Étalonne le convertisseur analogique/numérique interne.

\* Les constantes sont enregistrées après cette configuration.

4. Entrez la valeur mesurée sur le voltmètre numérique à l'aide du clavier numérique ou du bouton.

**REMARQUE** Cette configuration dure environ 15 secondes.

5. Débranchez tous les câbles de l'instrument.

[Rubrique d'étalonnage précédente](#)   [Rubrique d'étalonnage suivante](#)

### Réglage de l'auto-étalonnage - Série 33500

1. Entrez le réglage suivant.

Réglage	
7*	Auto-étalonnage. La sortie est désactivée.

\* Les constantes sont enregistrées après cette configuration.

2. Ensuite :
  - a. Si vos procédures d'étalonnage requièrent la vérification du réglage qui vient d'être effectué, quittez le menu d'étalonnage et procédez à la **vérification de la tension CC résiduelle**.

- b. Si vous effectuez tous les réglages sur un instrument 2 voies et vérifiez ensuite le fonctionnement de l'instrument, passez à la procédure suivante de cette section.

**REMARQUE** Cette configuration dure environ 15 secondes.

[Rubrique d'étalonnage précédente](#) [Rubrique d'étalonnage suivante](#)

## Réglage de l'impédance de sortie - Série 33500

L'instrument enregistre les constantes d'étalonnage de l'impédance de sortie des voies. Ces constantes sont générées avec et sans atténuateur de post-amplification.

1. Réglez le multimètre numérique pour mesurer des résistances à décalage compensé sur 4 fils. Réglez le multimètre numérique pour utiliser l'intégration 100 NPLC. Connectez les entrées Ohms Source et Ohms Sense du multimètre numérique à la sortie de la voie, comme illustré ci-dessous.

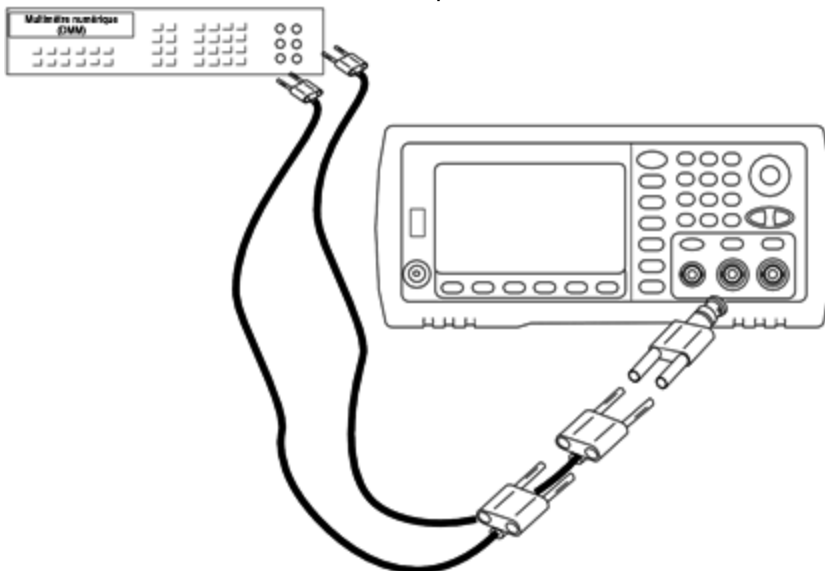

2. Utilisez le multimètre numérique pour mesurer une résistance sur 4 fils sur le connecteur de la face avant pour chaque réglage figurant dans le tableau suivant. La valeur mesurée attendue est approximativement de 50  $\Omega$ .

Réglage	
8*	Plage -24 dB du post-atténuateur
9*	0 dB

\* Les constantes sont enregistrées après cette configuration.

3. À l'aide du clavier numérique ou du bouton, réglez l'impédance affichée pour chaque réglage sur l'impédance mesurée. Sélectionnez **ENTER VALUE**.
4. Il n'existe pas de test de vérification du fonctionnement pour l'impédance de sortie. Passez à la procédure de réglage suivante de cette section.

[Rubrique d'étalonnage précédente](#) [Rubrique d'étalonnage suivante](#)

## Réglage de l'amplitude CA (haute impédance) - Série 33500

L'instrument enregistre une constante d'étalonnage pour chaque voie de propagation vers l'atténuateur haute impédance. Le coefficient du gain de la propagation est calculé avec deux mesures : une avec le convertisseur N/A du signal sur la sortie + et l'autre avec le convertisseur N/A sur la sortie -. Par conséquent, les réglages doivent être effectués deux par deux.

1. Connectez le multimètre numérique à la sortie de la voie, comme indiqué ci-dessous.

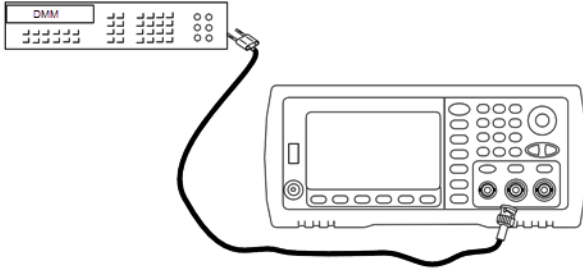

2. Utilisez le multimètre numérique pour mesurer la tension CC sur le connecteur de la face avant pour chaque réglage figurant dans le tableau suivant.

Réglage	Signal nominal	
	Niveau CC	
10	+0,0028 V	Sortie dans la plage -72 dB
11*	-0,0028 V	Sortie dans la plage -72 dB
12	+0,007 V	Sortie dans la plage -64 dB
13*	-0,007 V	Sortie dans la plage -64 dB
14	+0,017 V	Sortie dans la plage -56 dB
15*	-0,017 V	Sortie dans la plage -56 dB
16	+0,044 V	Sortie dans la plage -48 dB
17*	-0,044 V	Sortie dans la plage -48 dB
18	+0,11 V	Sortie dans la plage -40 dB
19*	-0,11 V	Sortie dans la plage -40 dB
20	+0,28 V	Sortie dans la plage -32 dB
21*	-0,28 V	Sortie dans la plage -32 dB
22	+0,68 V	Sortie dans la plage -24 dB
23*	-0,68 V	Sortie dans la plage -24 dB
24	+1,7 V	Sortie dans la plage -16 dB
25*	-1,7 V	Sortie dans la plage -16 dB
26	+4,3 V	Sortie dans la plage -8 dB
27*	-4,3 V	Sortie dans la plage -8 dB
28	+10,8 V	Sortie dans la plage 0 dB
29*	-10,8 V	Sortie dans la plage 0 dB
30	+0,044 V	Sortie dans la plage CC haute -48 dB
31*	-0,044 V	Sortie dans la plage CC haute -48 dB
32	+0,11 V	Sortie dans la plage CC haute -40 dB
33*	-0,11 V	Sortie dans la plage CC haute -40 dB
34	+0,28 V	Sortie dans la plage CC haute -32 dB

Réglage	Signal nominal	
	Niveau CC	
35*	-0,28 V	Sortie dans la plage CC haute -32 dB
36	+0,68 V	Sortie dans la plage CC haute -24 dB
37*	-0,68 V	Sortie dans la plage CC haute -24 dB

\* Les constantes sont enregistrées après cette configuration.

3. À l'aide du clavier numérique ou du bouton, réglez la tension affichée pour chaque réglage sur la tension mesurée. Sélectionnez **ENTER VALUE**.
4. Ensuite :
  - a. Si vos procédures d'étalonnage requièrent la vérification de ce réglage, quittez le menu d'étalonnage et procédez à la **vérification de l'amplitude CA (haute impédance)**.
  - b. Si vous effectuez tous les réglages sur un instrument 2 voies et vérifiez ensuite le fonctionnement de l'instrument, passez à la procédure suivante de cette section.

[Rubrique d'étalonnage précédente](#)   [Rubrique d'étalonnage suivante](#)

### Réglage de la planéité dans la plage -24 dB - Série 33500

1. Connectez un voltmètre CA de précision pour mesurer l'amplitude de sortie, comme indiqué ci-dessous. Connectez le câble BNC à l'entrée large bande de l'instrument Fluke 5790A.

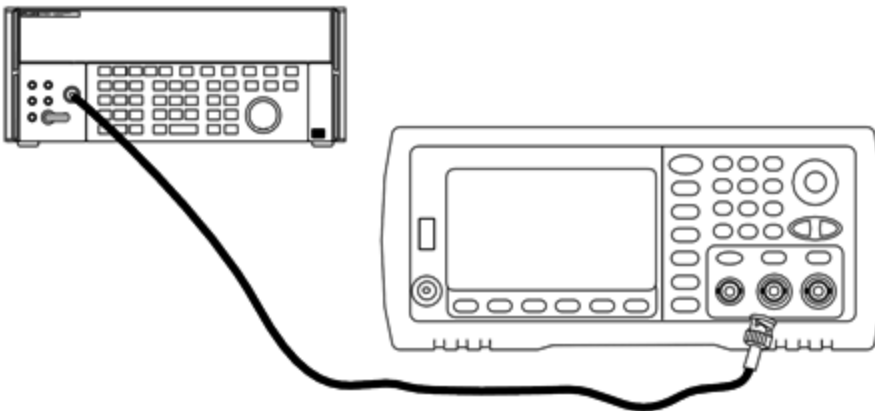

- Utilisez le voltmètre CA de précision pour mesurer l'amplitude de sortie de chaque réglage figurant dans le tableau ci-dessous.

Réglage	Signal nominal		
	Fréquence	Amplitude	
38*	1 kHz	0,192 Veff	Planéité de la plage -24 dB
39*	100 kHz		
40*	1 MHz		
41*	5 MHz		
42*	10 MHz		
43*	20 MHz		
44*	25 MHz		
45*	30 MHz		

\* Les constantes sont enregistrées après cette configuration.

- À l'aide du clavier numérique ou du bouton, réglez la tension affichée pour chaque réglage sur la tension mesurée. Sélectionnez **ENTER VALUE**.
- Ensuite :
  - Si vos procédures d'étalonnage requièrent la vérification du réglage qui vient d'être effectué, quittez le menu d'étalonnage et procédez à la **vérification de la planéité dans la plage -24 dB**.
  - Si vous effectuez tous les réglages sur un instrument 2 voies et vérifiez ensuite le fonctionnement de l'instrument, passez à la procédure suivante de cette section.

[Rubrique d'étalonnage précédente](#)   [Rubrique d'étalonnage suivante](#)

### Réglage de la planéité dans la plage -8 dB - Série 33500

- Connectez un voltmètre CA de précision pour mesurer l'amplitude de sortie, comme indiqué ci-dessous. Connectez le câble BNC à l'entrée large bande de l'instrument Fluke 5790A.

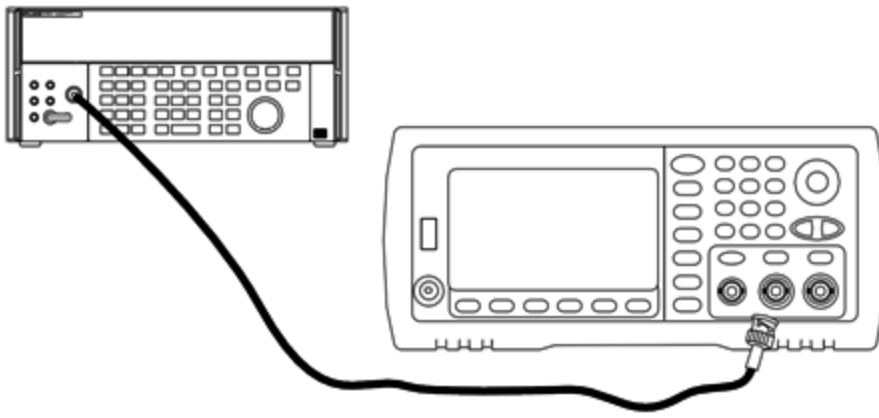

2. Utilisez le voltmètre CA de précision pour mesurer l'amplitude de sortie de chaque réglage figurant dans le tableau ci-dessous.

Réglage	Signal nominal		
	Fréquence	Amplitude	
46*	1 kHz	1,22 V <sub>eff</sub>	Planéité de la plage -8 dB
47*	100 kHz		
48*	1 MHz		
49*	5 MHz		
50*	10 MHz		
51*	20 MHz		
52*	25 MHz		
53*	30 MHz		

\* Les constantes sont enregistrées après cette configuration.

3. À l'aide du clavier numérique ou du bouton, réglez la tension affichée pour chaque réglage sur la tension mesurée. Sélectionnez **ENTER VALUE**.
4. Ensuite :
- Si vos procédures d'étalonnage requièrent la vérification du réglage qui vient d'être effectué, quittez le menu d'étalonnage et procédez à la **Vérification de la planéité dans la plage -8 dB**.
  - Si vous effectuez les réglages et vérifiez ensuite le fonctionnement de l'instrument, vérifiez les spécifications de sortie en effectuant les **tests de vérification des performances**.

Les procédures de réglage d'un instrument 1 voie sont à présent terminées. Une vérification des spécifications de sortie est recommandée.

Si vous effectuez les réglages sur un instrument 2 voies, passez à la procédure suivante de cette section.

[Rubrique d'étalonnage précédente](#)   [Rubrique d'étalonnage suivante](#)



## Réglages de la voie 2 - Série 33500

Les rubriques suivantes décrivent les réglages d'étalonnage de la voie 2.

- [Réglage de l'auto-étalonnage \(voie 2\)](#)
- [Réglage de l'impédance de sortie \(voie 2\)](#)
- [Réglage de l'amplitude CA \(haute impédance\) \(voie 2\)](#)
- [Réglage de la planéité dans la plage -24 dB \(voie 2\)](#)
- [Réglage de la planéité dans la plage -8 dB \(voie 2\)](#)

[Rubrique d'étalonnage précédente](#)   [Rubrique d'étalonnage suivante](#)

### Réglage de l'auto-étalonnage (voie 2) - Série 33500

1. Entrez le réglage suivant.

Réglage	
54*	Auto-étalonnage. La sortie est désactivée.

\* Les constantes sont enregistrées après cette configuration.

2. Ensuite :

- Si vos procédures d'étalonnage requièrent la vérification du réglage qui vient d'être effectué, quittez le menu d'étalonnage et procédez à la [vérification de la tension CC résiduelle](#). Assurez-vous d'effectuer cette opération pour la voie 2.
- Si vous effectuez tous les réglages sur un instrument 2 voies et vérifiez ensuite le fonctionnement de l'instrument, passez à la procédure suivante de cette section.

**REMARQUE** Cette configuration dure environ 15 secondes.

[Rubrique d'étalonnage précédente](#)   [Rubrique d'étalonnage suivante](#)

### Réglage de l'impédance de sortie (voie 2) - Série 33500

L'instrument enregistre les constantes d'étalonnage de l'impédance de sortie des voies. Ces constantes sont générées avec et sans atténuateur de post-amplification.

- Réglez le multimètre numérique pour mesurer des résistances à décalage compensé sur 4 fils. Réglez le multimètre numérique pour utiliser l'intégration 100 NPLC. Connectez les entrées Ohms Source et Ohms Sense du multimètre numérique à la sortie de la voie, comme illustré ci-dessous.

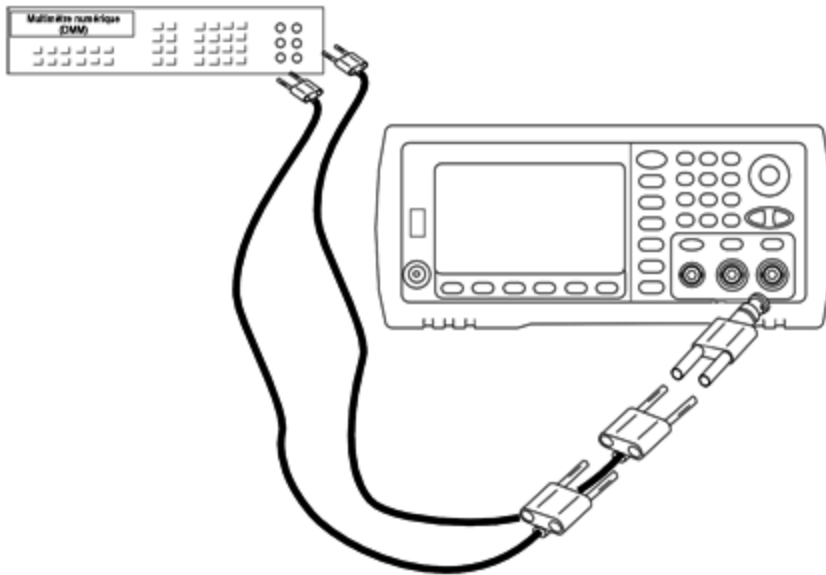

- Utilisez le multimètre numérique pour mesurer une résistance sur 4 fils sur le connecteur de la face avant pour chaque réglage figurant dans le tableau suivant. La valeur mesurée attendue est approximativement de  $50 \Omega$ .

Réglage	
55*	Plage -24 dB du post-atténuateur
56*	0 dB

\* Les constantes sont enregistrées après cette configuration.

- À l'aide du clavier numérique ou du bouton, réglez l'impédance affichée pour chaque réglage sur l'impédance mesurée. Sélectionnez **ENTER VALUE**.
- Il n'existe pas de test de vérification du fonctionnement pour l'impédance de sortie. Passez à la procédure de réglage suivante de cette section.

[Rubrique d'étalonnage précédente](#)   [Rubrique d'étalonnage suivante](#)

### Réglage de l'amplitude CA (haute impédance) (voie 2) - Série 33500

L'instrument enregistre une constante d'étalonnage pour chaque voie de propagation vers l'atténuateur haute impédance. Le coefficient du gain de la propagation est calculé avec deux mesures : une avec le convertisseur N/A du signal sur la sortie + et l'autre avec le convertisseur N/A sur la sortie -. Par conséquent, les réglages doivent être effectués deux par deux.

1. Connectez le multimètre numérique à la sortie de la voie, comme indiqué ci-dessous.

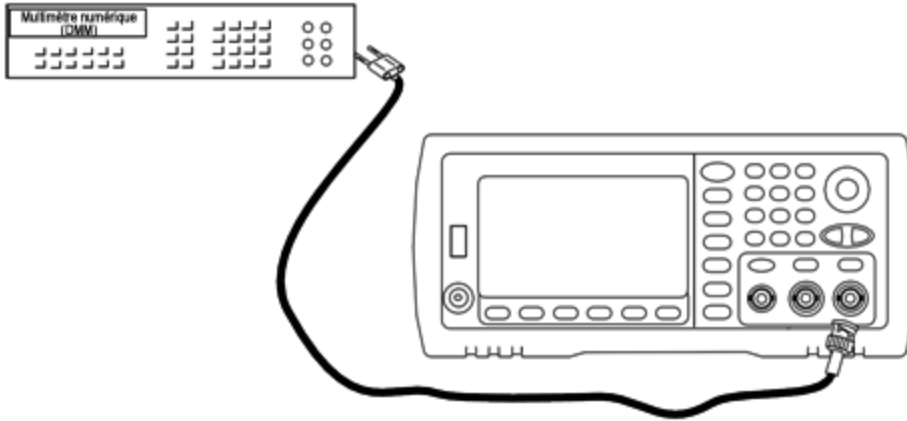

2. Utilisez le multimètre numérique pour mesurer la tension CC sur le connecteur de la face avant pour chaque réglage figurant dans le tableau suivant.

	<b>Signal nominal</b>	
<b>Réglage</b>	<b>Niveau CC</b>	
57	+0,0028 V	Sortie dans la plage -72 dB
58*	-0,0028 V	Sortie dans la plage -72 dB
59	+0,007 V	Sortie dans la plage -64 dB
60*	-0,007 V	Sortie dans la plage -64 dB
61	+0,017 V	Sortie dans la plage -56 dB
62*	-0,017 V	Sortie dans la plage -56 dB
63	+0,044 V	Sortie dans la plage -48 dB
64*	-0,044 V	Sortie dans la plage -48 dB
65	+0,11 V	Sortie dans la plage -40 dB
66*	-0,11 V	Sortie dans la plage -40 dB
67	+0,28 V	Sortie dans la plage -32 dB
68*	-0,28 V	Sortie dans la plage -32 dB
69	+0,68 V	Sortie dans la plage -24 dB
70*	-0,68 V	Sortie dans la plage -24 dB
71	+1,7 V	Sortie dans la plage -16 dB
72*	-1,7 V	Sortie dans la plage -16 dB
73	+4,3 V	Sortie dans la plage -8 dB
74*	-4,3 V	Sortie dans la plage -8 dB
75	+10,8 V	Sortie dans la plage 0 dB
76*	-10,8 V	Sortie dans la plage 0 dB
77	+0,044 V	Sortie dans la plage CC haute -48 dB
78*	-0,044 V	Sortie dans la plage CC haute -48 dB
79	+0,11 V	Sortie dans la plage CC haute -40 dB
80*	-0,11 V	Sortie dans la plage CC haute -40 dB
81	+0,28 V	Sortie dans la plage CC haute -32 dB

	Signal nominal	
Réglage	Niveau CC	
82*	-0,28 V	Sortie dans la plage CC haute -32 dB
83	+0,68 V	Sortie dans la plage CC haute -24 dB
84*	-0,68 V	Sortie dans la plage CC haute -24 dB

\* Les constantes sont enregistrées après cette configuration.

3. À l'aide du clavier numérique ou du bouton, réglez la tension affichée pour chaque réglage sur la tension mesurée. Sélectionnez **ENTER VALUE**.
4. Ensuite :
  - a. Si vos procédures d'étalonnage requièrent la vérification de ce réglage, quittez le menu d'étalonnage et procédez à la **vérification de l'amplitude CA (haute impédance)**.
  - b. Si vous effectuez tous les réglages sur un instrument 2 voies et vérifiez ensuite le fonctionnement de l'instrument, passez à la procédure suivante de cette section.

[Rubrique d'étalonnage précédente](#)   [Rubrique d'étalonnage suivante](#)

#### Réglage de la planéité dans la plage -24 dB (voie 2) - Série 33500

1. Connectez un voltmètre CA de précision pour mesurer l'amplitude de sortie, comme indiqué ci-dessous. Connectez le câble BNC à l'entrée large bande de l'instrument Fluke 5790A.

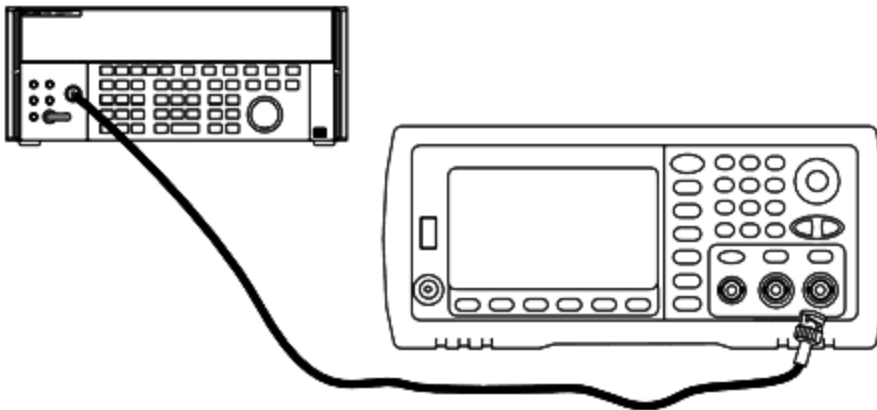

2. Utilisez le voltmètre CA de précision pour mesurer l'amplitude de sortie de chaque réglage figurant dans le tableau ci-dessous.

Réglage	Signal nominal		
	Fréquence	Amplitude	
85*	1 kHz	0,192 V <sub>eff</sub>	Planéité de la plage -24 dB
86*	100 kHz		
87*	1 MHz		
88*	5 MHz		
89*	10 MHz		
90*	20 MHz		
91*	25 MHz		
92*	30 MHz		

\* Les constantes sont enregistrées après cette configuration.

3. À l'aide du clavier numérique ou du bouton, réglez la tension affichée pour chaque réglage sur la tension mesurée. Sélectionnez **ENTER VALUE**.
4. Ensuite :
  - a. Si vos procédures d'étalonnage requièrent la vérification du réglage qui vient d'être effectué, quittez le menu d'étalonnage et procédez à la **vérification de la planéité dans la plage -24 dB**. Assurez-vous d'effectuer cette opération pour la voie 2.
  - b. Si vous effectuez tous les réglages sur un instrument 2 voies et vérifiez ensuite le fonctionnement de l'instrument, passez à la procédure suivante de cette section.

[Rubrique d'étalonnage précédente](#)   [Rubrique d'étalonnage suivante](#)

### Réglage de la planéité dans la plage -8 dB (voie 2) - Série 33500

Cette section concerne la voie 2. Elle vérifie la planéité de l'amplitude CA haute fréquence dans la plage -8 dB de l'atténuateur. Elle vérifie également la planéité sur toutes les autres plages, à l'exclusion des plages -24 dB et 0 dB de l'atténuateur.

1. Connectez un voltmètre CA de précision pour mesurer l'amplitude de sortie, comme indiqué ci-dessous. Connectez le câble BNC à l'entrée large bande de l'instrument Fluke 5790A.

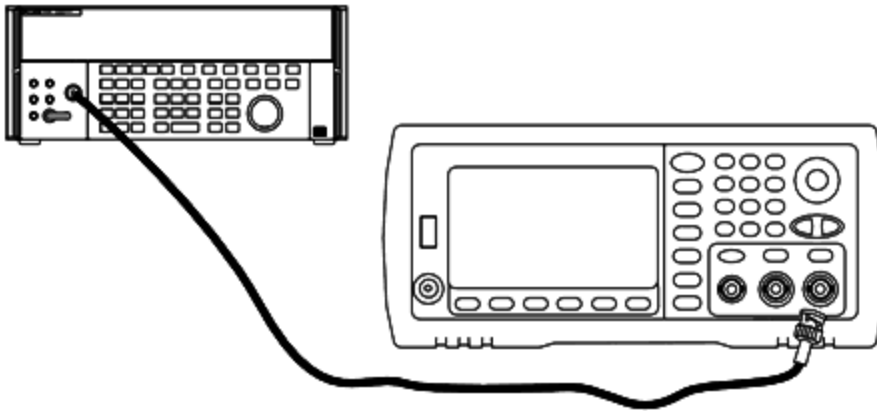

2. Utilisez le voltmètre CA de précision pour mesurer l'amplitude de sortie de chaque réglage figurant dans le tableau ci-dessous.

Signal nominal			
Réglage	Fréquence	Amplitude	
93*	1 kHz	1,22 V <sub>eff</sub>	Planéité de la plage -8 dB
94*	100 kHz		
95*	1 MHz		
96*	5 MHz		
97*	10 MHz		
98*	20 MHz		
99*	25 MHz		
100	30 MHz		

\* Les constantes sont enregistrées après cette configuration.

3. À l'aide du clavier numérique ou du bouton, réglez la tension affichée pour chaque réglage sur la tension mesurée. Sélectionnez **ENTER VALUE**.
4. Les procédures de réglage recommandées sont à présent terminées. Une vérification des spécifications de sortie est recommandée.
- a. Si vos procédures d'étalonnage requièrent la vérification du réglage qui vient d'être effectué, quittez le menu d'étalonnage et procédez à la **Vérification de la planéité dans la plage -8 dB**.

[Rubrique d'étalonnage précédente](#) [Rubrique d'étalonnage suivante](#)

## Erreurs d'étalonnage - Série 33500

Les erreurs suivantes peuvent se produire pendant l'étalonnage. Des **erreurs système** et des **erreurs d'autotest** sont également possibles. Certains messages d'erreur incluent un numéro de voie défectueuse (1 ou 2), indiqué sous la forme n dans les messages ci-dessous.

**701 Calibration error; security defeated by hardware jumper**

Si vous mettez en court-circuit le cavalier de sécurité de l'étalonnage (CAL ENABLE) lorsque vous allumez l'instrument, cette erreur indique que le mot de passe de sécurité a été remplacé. Pour plus d'informations, reportez-vous à la section [Sécurité de l'étalonnage](#).

**702 Calibration error; calibration memory is secured**

Pour effectuer l'étalonnage, déverrouillez la sécurité de l'instrument. Pour plus d'informations, reportez-vous à la section [Sécurité de l'étalonnage](#).

**703 Calibration error; secure code provided was invalid**

Le code de sécurité spécifié n'était pas valide.

**706 Calibration error; value out of range**

La valeur saisie est hors de la plage valide.

**707 Calibration error; signal input is out of range**

Se produit pendant le réglage du convertisseur analogique/numérique (réglage 6) si la tension d'entrée 1 V est trop élevée. Peut également se produire pendant l'auto-étalonnage (réglage 7). Exécutez l'autotest pour diagnostiquer le problème.

**710 Self-calibration failed; Chan n, null DAC cal, invalid self cal**  
**Self-calibration failed; Chan n, offset DAC cal with attenuator, invalid self cal**  
**Self-calibration failed; Chan n, offset DAC cal no attenuator, invalid self cal**

Erreur lors de l'étalonnage interne du convertisseur numérique/analogique spécifié. Auto-étalonnage terminé sans modification des constantes d'auto-étalonnage. Exécutez l'autotest pour diagnostiquer le problème.

**711 Self-calibration failed; Chan n, null DAC cal gain too low (too high), <valeur\_mes>**  
**Self-calibration failed; Chan n, offset DAC cal with attenuator gain too low (too high), <valeur\_mes>**  
**Self-calibration failed; Chan n, offset DAC cal no attenuator gain too low (too high), <valeur\_mes>**

Le facteur d'étalonnage du gain calculé pour le convertisseur numérique/analogique était hors limites. Auto-étalonnage terminé sans modification des constantes d'auto-étalonnage. Exécutez l'autotest pour diagnostiquer le problème.

**712 Self-calibration failed; Chan n, null DAC cal zero too low (too high), <valeur\_mes>**  
**Self-calibration failed; Chan n, offset DAC cal no attenuator zero too low (too high), <valeur\_mes>**  
**Self-calibration failed; Chan n, offset DAC cal no attenuator zero too low (too high), <valeur\_mes>**  
**Self-calibration failed; Chan n, GND measurement out of limits, <valeur\_mes>**

Le facteur d'étalonnage du zéro calculé pour le convertisseur numérique/analogique était hors limites. Auto-étalonnage terminé sans modification des constantes d'auto-étalonnage. Exécutez l'autotest pour diagnostiquer le problème.



### **715 Self-calibration failed; Chan n, null DAC cal, convergence error sub attenuator value dB**

L'étalonnage à vide du convertisseur numérique/analogique interne était incohérent lors de l'étalonnage interne. Auto-étalonnage terminé sans modification des constantes d'auto-étalonnage. Exécutez l'autotest pour diagnostiquer le problème.

### **720 Self-calibration failed; Chan n, offset DAC cal with attenuator, convergence error Self-calibration failed; Chan n, offset DAC cal no attenuator, convergence error**

L'étalonnage de la tension résiduelle du convertisseur numérique/analogique interne était incohérent lors de l'étalonnage interne. Auto-étalonnage terminé sans modification des constantes d'auto-étalonnage. Exécutez l'autotest pour diagnostiquer le problème.

### **850 Calibration error; set up is invalid**

Le numéro du réglage d'étalonnage sélectionné est incorrect.

### **850 Calibration error; set up is out of order**

Certaines opérations d'étalonnage requièrent un paramètre de début et de fin. N'entrez pas au milieu d'une séquence d'étalonnage.

### **Rubrique d'étalonnage précédente**

## Présentation de l'étalonnage - Série 33600

Ce chapitre décrit les procédures de vérification des performances et des réglages (étalonnage) de l'instrument.

L'instrument utilise une méthode d'étalonnage électronique en boîtier fermé ; aucun réglage mécanique interne n'est nécessaire. L'instrument calcule les facteurs de correction en fonction des valeurs de référence en entrée que vous configurez et enregistre ces facteurs en mémoire non volatile jusqu'à l'étalonnage suivant. L'extinction de l'instrument ou l'exécution de la commande **\*RST** n'entraîne aucune modification de ces données.

## Services d'étalonnage Keysight Technologies

Votre Centre de maintenance Keysight Technologies propose un service de réétalonnage économique. Ce centre utilise des systèmes d'étalonnage automatique qui permettent à Keysight d'assurer ce service à des prix compétitifs.

## Étalonnage - Table des matières

Cette section contient les rubriques suivants :

### **Présentation de l'étalonnage**

- **Intervalle d'étalonnage**
- **Réglage recommandé**

- Temps nécessaire pour l'étalonnage
- Procédures d'étalonnage automatique
- Matériel de test recommandé
- Considérations relatives aux tests
- Nombre de points d'étalonnage
- Message d'étalonnage

Sécurité de l'étalonnage

Vérification

Tests de vérification des performances

- Autotest
- Vérification rapide des performances
- Tests de vérification des performances
- Procédures de vérification de l'amplitude et de la planéité

Vérification de la base de temps interne

Vérification de l'amplitude CA (haute impédance)

Vérification de la tension CC résiduelle

Vérification de la planéité dans la plage 1 Vpp

Vérification de la planéité dans la plage 4 Vpp

Vérification de la planéité dans la plage 8 Vpp

Procédure générale d'étalonnage/réglage

Abandon d'un étalonnage en cours

Ordre des réglages

Autotest

Réglage de la fréquence (base de temps interne)

Réglage du convertisseur analogique/numérique (ADC) interne

Réglage de l'auto-étalonnage

Réglage de l'impédance de sortie

Réglage de l'amplitude CA (haute impédance)

Réglage de la planéité 1 Vpp

Réglage de la planéité 4 Vpp

Réglage de la planéité 8 Vpp

### Réglage de la voie 2 (le cas échéant)

- Réglage de l'auto-étalonnage (voie 2)
- Réglage de l'impédance de sortie (voie 2)
- Réglage de l'amplitude CA (haute impédance) (voie 2)
- Réglage de la planéité dans la plage 1 Vpp (voie 2)
- Réglage de la planéité dans la plage 4 Vpp (voie 2)
- Réglage de la planéité 8 Vpp

### Erreurs d'étalonnage

### Rubrique d'étalonnage suivante

## Présentation de l'étalonnage - Série 33600

Cette section présente les fonctions d'étalonnage de l'instrument. Pour des informations détaillées sur l'étalonnage, reportez-vous à la section [Présentation de l'étalonnage](#).

### Intervalle d'étalonnage

L'instrument doit être étalonné régulièrement à une fréquence qui dépend de la précision nécessaire à votre application. Un intervalle d'un an convient à la plupart des applications. Les spécifications de précision sont garanties uniquement si l'étalonnage est effectué régulièrement. Au-delà d'un an, elles ne sont plus garanties. Keysight Technologies recommande de ne pas laisser passer plus de 2 ans entre deux étalonnages, quelle que soit l'application.

### Réglage recommandé

Quelle que soit la fréquence d'étalonnage choisie, Keysight Technologies recommande de procéder à un réétalonnage complet au terme de cette durée. De cette manière, l'instrument conserve ses caractéristiques jusqu'à l'étalonnage suivant et offre une meilleure stabilité à long terme. Les caractéristiques fonctionnelles mesurées avec cette méthode peuvent être utilisées pour prolonger la fréquence d'étalonnage. Utilisez le nombre de points d'étalonnage pour vérifier que tous les réglages ont été effectués.

### Temps nécessaire pour l'étalonnage

Pour la vérification d'un instrument reçu, effectuez d'abord les tests de vérification des performances. Effectuez ensuite les réglages et exécutez à nouveau les tests de fonctionnement. Si elle est effectuée manuellement, chaque opération dure environ 30 minutes par voie.

Vous pouvez également étalonner automatiquement l'instrument à l'aide d'un ordinateur. Avec un ordinateur, la procédure complète d'étalonnage et les tests de vérification des performances durent environ 30 minutes (une voie) ou 60 minutes (deux fois) lorsque l'instrument est préchauffé (voir [Considérations relatives aux tests](#)).

## Procédures d'étalonnage automatique

Vous pouvez utiliser un équipement de test programmable pour automatiser les procédures de vérification et de réglage. Vous pouvez programmer la configuration de chaque test de l'instrument sur l'interface distante. Entrez ensuite les données vérifiées dans un programme de test et comparez les résultats à la limite de test correspondante.

Vous pouvez également régler l'instrument à partir de l'interface distante ; cette procédure est similaire à celle qui est utilisée sur la face avant. Utilisez un ordinateur pour effectuer le réglage ; sélectionnez d'abord la fonction et la plage désirées sur l'équipement de mesure. Envoyez la valeur d'étalonnage à l'instrument et démarrez l'étalonnage sur l'interface distante.

Vous devez **déverrouiller la sécurité de l'instrument** avant l'étalonnage.

Séquence de programmation type pour une configuration d'étalonnage :

1. **CAL:SETup 2** (configurer l'instrument pour l'opération d'étalonnage n°2)
2. Mesurer la fréquence de sortie avec le fréquencemètre externe
3. **CAL:VALue 9.99994321E6** (envoyer la valeur mesurée à l'instrument)
4. **CAL?** (démarre l'étalonnage pour la configuration n°2)
5. Lire la valeur de la requête **CAL?** pour déterminer l'échec (+1) ou la réussite (+0) du réglage
6. **CAL:SETup 3** (configure l'instrument pour l'opération d'étalonnage n°3)

Pour plus d'informations sur la programmation de l'instrument, reportez-vous à la section **Présentation du langage SCPI**.

## Matériel de test recommandé

L'équipement nécessaire aux tests de performances et aux procédures de réglage est répertorié ci-dessous. Si l'instrument recommandé est indisponible, vous pouvez le remplacer par un autre de précision équivalente.

Instrument	Conditions requises	Modèle recommandé	Utilisation *
Multimètre numérique (DMM)	Vca, valeurs efficaces, précision du couplage CA : $\pm 0,02\%$ à 1 MHz Précision Vcc : Résolution 50 ppm : Précision de la résistance sous 100 $\mu\text{V}$ avec compensation de la tension résiduelle : $\pm 0,1\ \Omega$	Keysight 3458A	Q, P, T
Voltmètre CA de précision	Précision 1 000 Hz à 30 MHz, 0,1 V <sub>eff</sub> à 2 V <sub>eff</sub> (-7 dBm à +20 dBm) : Résolution 0,02 dB : 0,01 dB	Fluke 5790A	Q, P, T
Fréquencemètre	Précision : 0,1 ppm	Keysight 53230A Opt 010 (OCXO)	Q, P, T
Sonde de puissance	Modèle spécifique	Keysight N8482A	Q, P, T

Instrument	Conditions requises	Modèle recommandé	Utilisation *
Wattmètre	Modèle spécifique (sélectionnez l'un des quatre modèles)	Keysight N1911A, N1912A, N1913A ou N1914A	Q, P, T
Oscilloscope	Impédance d'entrée 1 GHz 4 Gs/seconde 50 $\Omega$	Keysight MSO6104A	T
Adaptateur	Type N (m) sur BNC (m)	Keysight E9623A	Q, P, T
Câble (2 requis)	Double fiche banane (m) sur double fiche banane (m)	Keysight 11000-60000	Q, P, T
Câble	RG58, BNC (m) sur double fiche banane OU Câble coaxial RG58 avec BNC (m) sur double adaptateur banane		Q, P, T
Câble	RG58, BNC (m) sur BNC (m)	Keysight 11170C	Q, P, T
Câble à faible perte	Utilisé pour un branchement à un atténuateur de type N, Fluke 5790A et N8482A. Planéité vérifiée par l'analyseur de réseau de précision (PNA)	(N'importe lequel dès lorsqu'il est vérifié par le PNA)	Q, P, T
Atténuateur 10 à 20 dB	Planéité vérifiée par l'analyseur de réseau de précision (PNA)	(N'importe lequel dès lorsqu'il est vérifié par le PNA)	Q, P, T

\* Q = vérification rapide P = vérification des performances T = dépannage

### Considérations relatives aux tests

Pour des résultats optimaux, respectez les recommandations suivantes pour toutes les procédures :

- Température ambiante stable pour l'étalonnage (de 18 à 28 °C). La température idéale est 23  $\pm$ 1 °C.
- Humidité relative inférieure à 80 %.
- Chauffage d'une heure avant la vérification ou le réglage.
- Câbles de mesure les plus courts possibles et adaptés à l'impédance.
- Câble RG-58 ou 50  $\Omega$  équivalent.

### Nombre de points d'étalonnage

Vous pouvez interroger l'instrument afin de déterminer le nombre de points d'étalonnage effectués. L'instrument a été étalonné en usine. À la réception de l'instrument, lisez le nombre de points d'étalonnage pour déterminer sa valeur initiale.

- Ce paramètre est non volatile ; il n'est pas modifié par une remise sous tension ou l'exécution de la commande **\*RST**.

- Du fait que le nombre de points augmente d'une unité pour chaque point étalonné qui enregistre une valeur, un étalonnage complet augmente ce nombre considérablement.



- Face avant :
- SCPI : **CAL:COUNT?**

### Message d'étalonnage

Vous pouvez enregistrer un message contenant jusqu'à 40 caractères dans la mémoire d'étalonnage. Par exemple, vous pouvez enregistrer la date du dernier étalonnage, celle à laquelle doit être effectué le prochain étalonnage, le numéro de série de l'instrument ou les coordonnées des techniciens d'étalonnage.

Déverrouillez la sécurité de l'instrument pour enregistrer un message d'étalonnage. Vous pouvez lire le message d'étalonnage sur la face avant ou l'interface distante, que l'instrument soit ou non verrouillé.

- L'enregistrement d'un message d'étalonnage entraîne le remplacement de tout message précédemment enregistré.
- Ce paramètre est non volatile ; il n'est pas modifié par une remise sous tension ou l'exécution de la commande **\*RST**.



- Face avant :
- SCPI : **CAL:STR "Cal Due: 01 August 2012"**

[Rubrique d'étalonnage précédente](#)   [Rubrique d'étalonnage suivante](#)

## Sécurité de l'étalonnage - Série 33600

Cette section décrit le système de sécurité de l'étalonnage de l'instrument.

### Présentation de la sécurité

Un code de sécurité empêche les réglages accidentels ou non autorisés de l'instrument. Le code de sécurité par défaut configuré en usine pour les instruments de la série 33600 est **AT33600**.

- Une fois que vous avez saisi un code de sécurité, vous devez l'utiliser pour les opérations sur la face avant et l'interface distante. Si vous verrouillez l'instrument sur la face avant, vous devez utiliser ce même code pour le déverrouiller à partir de l'interface distante.

- Ce paramètre est non volatile ; il n'est pas modifié par une remise sous tension ou l'exécution de la commande \*RST.
- Règles applicables aux codes de sécurité :  
Chaîne de 12 caractères maximum sans guillemets  
Doit commencer par une lettre (A-Z)  
Peut contenir des lettres, des chiffres (0 à 9) et le caractère de soulignement
- Face avant :



- SCPI : `CALibration_SECURITY:STATe`

### Déverrouillage de l'instrument sans code de sécurité

**ATTENTION** Avant de démarrer cette procédure, reportez-vous à la section **Précautions contre les décharges électrostatiques (ESD)**.

1. Débranchez le cordon d'alimentation, ainsi que toutes les connexions d'entrée et de sortie.
2. Démontez l'instrument (voir la section **Démontage - Série 33600**).
3. Sur la série 33600, appliquez un court-circuit momentané entre les broches A1 et B1 de la carte à circuit imprimé de la face avant, comme indiqué ci-dessous.

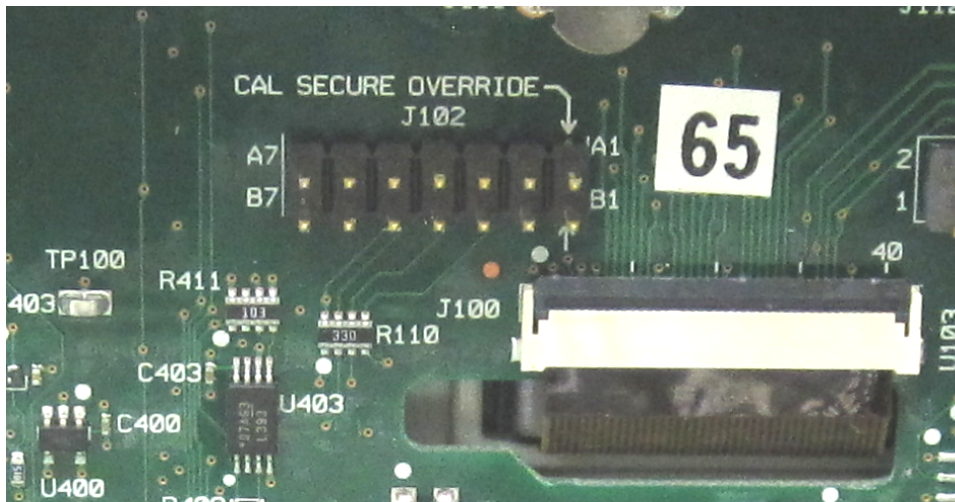

4. Branchez le cordon d'alimentation et mettez l'instrument sous tension.

**AVERTISSEMENT** Veillez à ne pas toucher les connexions de l'alimentation ou les hautes tensions présentes sur le module d'alimentation. La tension d'alimentation est présente, même si l'instrument est éteint.

5. La file des messages d'erreur affiche le message « Calibration security has been disabled ».

La sécurité de l'étalonnage est déverrouillée ; le mot de passe est alors rétabli à sa valeur par défaut configurée en usine. Le nombre de points d'étalonnage augmente d'une unité, car le cavalier était connecté pendant la mise sous tension ; le message d'erreur **+701, "Calibration error; security defeated by hardware jumper"** s'affiche. L'enregistrement de l'étalonnage en mémoire non volatile est mis à jour pour tenir compte de ces opérations.

6. Éteignez l'instrument, enlevez le cavalier de court-circuit et le cordon d'alimentation.
7. Remontez l'instrument.
8. Entrez un nouveau code de sécurité (voir ci-dessus) et conservez ce code dans un endroit sûr.

[Rubrique d'étalonnage précédente](#)   [Rubrique d'étalonnage suivante](#)

## Vérification - Série 33600

Les rubriques suivantes décrivent la partie de vérification de la procédure d'étalonnage :

- [Tests de vérification des performances](#)
- [Vérification de la base de temps interne](#)
- [Vérification de l'amplitude CA \(haute impédance\)](#)
- [Vérification de la tension CC résiduelle](#)
- [Vérification de la planéité dans la plage 1 Vpp](#)
- [Vérification de la planéité dans la plage 4 Vpp](#)
- [Vérification de la planéité dans la plage 8 Vpp](#)

[Rubrique d'étalonnage précédente](#)   [Rubrique d'étalonnage suivante](#)

## Tests de vérification des performances - Série 33600

Ces tests permettent de vérifier les performances de mesure de l'instrument. Ils reposent sur les spécifications de l'instrument figurant dans la fiche technique du produit.

Il existe trois niveaux de tests de vérification des performances :

- **Autotest** Ensemble de tests de vérification internes qui permettent de s'assurer que l'instrument fonctionne correctement.
- **Vérification rapide** Combinaison des autotests internes et des tests de vérification sélectionnés.
- **Tests de vérification des performances** Ensemble complet de tests recommandés comme test de recette à la réception de l'instrument ou après avoir effectué des réglages.



## Autotest

Un bref autotest de mise sous tension est effectué automatiquement à chaque mise sous tension de l'instrument. Il certifie que l'instrument est opérationnel. Pour plus d'informations, reportez-vous à la section [Procédures d'autotest](#).

## Vérification rapide des performances

La vérification rapide des performances regroupe l'autotest et un test de performances réduit (spécifié par la lettre Q dans les tests de vérification des performances). Ce test constitue une méthode simple de vérification du fonctionnement de l'instrument et de respect des spécifications. Ces tests représentent l'ensemble minimal de vérifications des performances recommandées après une intervention de maintenance. Le contrôle des performances de l'instrument pour les points de contrôle rapide (désignés par Q) vérifie le fonctionnement des mécanismes normaux de dérive de la précision. Ce test ne vérifie pas les défauts anormaux des composants.

Pour effectuer une vérification rapide des performances, procédez comme suit :

1. Effectuez un [autotest complet](#).
2. Effectuez uniquement les tests de vérification des performances indiqués par la lettre Q.
3. Si l'instrument échoue au contrôle rapide du fonctionnement, un réglage ou une réparation s'avèrent nécessaires.

## Tests de vérification des performances

Les tests de vérification des performances sont recommandés comme tests de recette technique lorsque vous recevez initialement l'instrument. Les résultats des tests de recette doivent être comparés aux spécifications figurant dans la fiche technique du produit. Par la suite, vous devrez répéter les tests de vérification des performances à chaque intervalle d'étalonnage.

Si l'instrument échoue aux tests de vérification du fonctionnement, un réglage ou une réparation s'avèrent nécessaires.

Un réglage est recommandé à chaque intervalle d'étalonnage. Si aucun réglage n'est effectué, vous devez protéger la bande, sans aller au-delà de 80 % des spécifications répertoriées dans la fiche technique, que vous utiliserez comme limites de vérification.

## Procédures de vérification de l'amplitude et de la planéité

Les procédures de vérification de la planéité utilisent un voltmètre CA de précision et un wattmètre. Vous pouvez remplacer les convertisseurs de tension thermiques (TVC) pour effectuer des mesures par des procédures opérationnelles et un équipement de test appropriés.

Le voltmètre CA de précision Fluke 5790A permet de mesurer l'amplitude entre 1 kHz et 20 MHz. Entre 20 et 120 MHz, un wattmètre équipé de la sonde de puissance N8482A est utilisé. Les mesures d'amplitude des modèles 5790A et N8482A entre 1 MHz et 20 MHz sont utilisées pour adapter le modèle N8482A au modèle 5790A.

[Rubrique d'étalonnage précédente](#)   [Rubrique d'étalonnage suivante](#)

## Vérification de la base de temps interne - Série 33600

Vérifie la précision de la fréquence de sortie. Toutes les fréquences de sortie sont dérivées d'une fréquence générée.

1. Connectez un fréquencemètre à la sortie de la voie 1, comme indiqué ci-dessous (l'entrée du fréquencemètre doit être terminée à 50  $\Omega$ ).

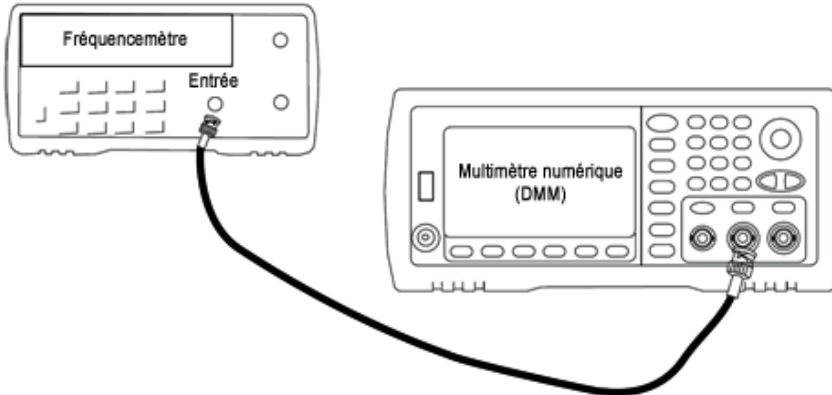

2. Configurez l'instrument sur la sortie décrite dans le tableau ci-dessous et mesurez la fréquence de sortie. Vérifiez que la sortie de l'instrument est active.

Utiliser	Générateur de signaux			Mesure	
	Fonction	Amplitude	Fréquence	Nominal	Erreur*
Q	Sinusoidal	1,00 Vpp	10,0000000 MHz	10,000 MHz	$\pm 10$ Hz

\* Avec la **base de temps OCXO haute stabilité en option**, l'erreur de mesure est égale à  $\pm 1$  Hz.

3. Comparez la valeur mesurée aux limites de test indiquées dans le tableau.

[Rubrique d'étalonnage précédente](#)   [Rubrique d'étalonnage suivante](#)

## Vérification de l'amplitude CA (haute impédance) - Série 33600

Vérifie la précision de l'amplitude CA à la fréquence de 1 kHz en utilisant chaque atténuateur.

1. Réglez le multimètre numérique pour mesurer les tensions efficaces. Connectez le multimètre numérique à la sortie de la voie, comme indiqué ci-dessous.

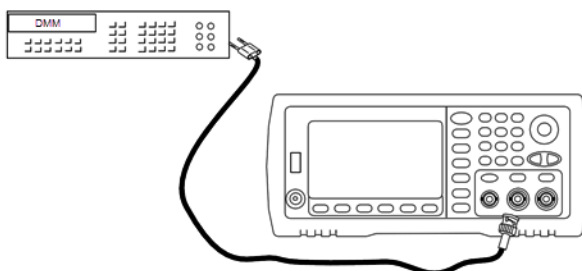

2. Configurez l'instrument sur chaque sortie indiquée dans le tableau ci-dessous et mesurez la tension de sortie à l'aide du multimètre numérique. Vérifiez que l'impédance de sortie est définie sur High-Z (Haute impédance) et que la sortie est activée.

Utiliser	Générateur de signaux				Mesure	
	Configuration de la sortie	Fonction	Fréquence	Amplitude	Nominal	Erreur*
Q	Haute impédance (High Z) **	Sinusoïdal	1,000 kHz	400,0 mVeff	400,0 mVeff	±0,004707 Veff
Q	High Z	Sinusoïdal	1,000 kHz	400,0 mVeff	400,0 mVeff	±0,004707 Veff
Q	High Z	Sinusoïdal	1,000 kHz	1,00 Veff	1,00 Veff	±0,010707 Veff
Q	High Z	Sinusoïdal	1,000 kHz	2,500 Veff	2,500 Veff	±0,025707 Veff
Q	High Z	Sinusoïdal	1,000 kHz	7,000 Veff	7,000 Veff	±0,070707 Veff

\* Sur la base de 1 % du réglage de ±1 mVpp (50 Ω) ; convertie en Veff pour une haute impédance.

\*\* Pour configurer cette sortie, procédez comme suit :

- a. Réglez l'amplitude sur 400,0 mVeff
  - b. Définissez la tension CC résiduelle à 1,0 Vcc
  - c. Désactivez l'échelle automatique (OFF)
  - d. Réglez la tension CC résiduelle sur 0,0 Vcc
  - e. Une fois la mesure effectuée, activez l'échelle automatique (ON) pour les autres mesures.
3. Comparez la valeur mesurée aux limites de test indiquées dans le tableau.
4. Instruments 2 voies uniquement : connectez le multimètre numérique à la sortie de la voie 2 et répétez les opérations 2 et 3.

[Rubrique d'étalonnage précédente](#)   [Rubrique d'étalonnage suivante](#)

### Vérification de la tension CC résiduelle - Série 33600

Vérifie la tension CC résiduelle sur deux plages de l'atténuateur :

1. Réglez le multimètre numérique pour mesurer des tensions continues. Connectez le multimètre numérique à la sortie de la voie, comme indiqué ci-dessous.

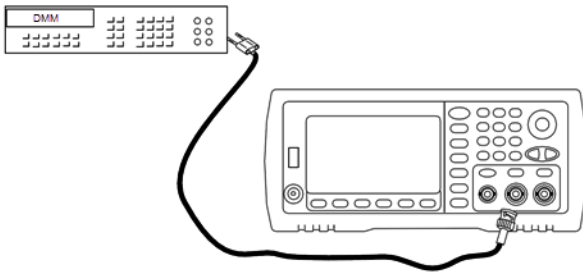

2. Configurez l'instrument sur chaque sortie indiquée dans le tableau ci-dessous et mesurez la tension de sortie à l'aide du multimètre numérique.

Utiliser	Générateur de signaux			Mesure	
	Configuration de la sortie	Fonction	Tension	Nominal	Erreur*
Q	High Z	CC	0,0 V	0,0 Vcc	±0,002 Vcc
Q	High Z	CC	500 mV	0,500 Vcc	±0,007 Vcc
Q	High Z	CC	10,0 V	10,0 Vcc	±0,102 Vcc

\* Sur la base de 1 % du réglage ±2 mVcc pour une haute impédance.

3. Comparez la valeur mesurée aux limites de test indiquées dans le tableau.
4. Instruments 2 voies uniquement : connectez le multimètre numérique à la sortie de la voie 2 et répétez les opérations 2 et 3.

[Rubrique d'étalonnage précédente](#) [Rubrique d'étalonnage suivante](#)

### Vérification de la planéité dans la plage 1 Vpp - Série 33600

Vérifie la planéité de l'amplitude CA haute fréquence dans la plage 1 Vpp.

1. Connectez un voltmètre CA de précision pour mesurer l'amplitude de sortie, comme indiqué ci-dessous. Connectez le câble BNC à l'entrée large bande de l'instrument Fluke 5790A. Si vous utilisez un matériel de test de remplacement, vérifiez que l'impédance d'entrée est égale à 50  $\Omega$ , car la précision de la charge affecte directement la qualité des mesures.

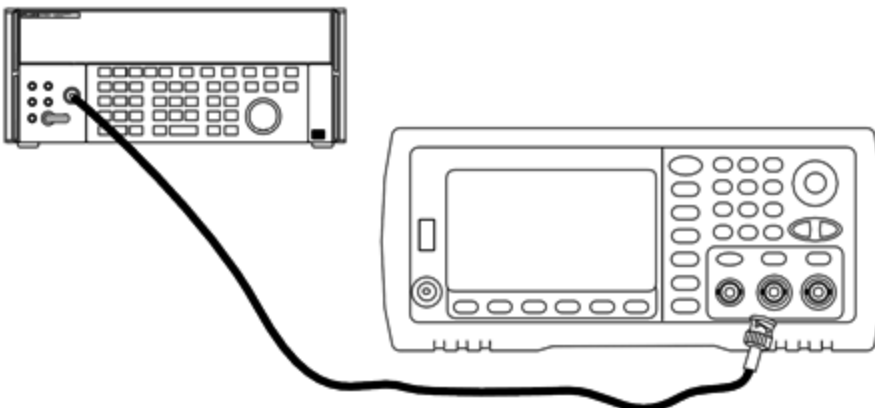

2. Réglez le voltmètre CA de précision sur « Intermédiaire, Intermédiaire » Filtre numérique et Redémarrage filtre.
3. Réglez l'impédance de sortie sur 50 Ω et vérifiez que la sortie est activée. Configurez l'instrument comme décrit dans le tableau ci-dessous et mesurez l'amplitude de sortie à l'aide du voltmètre CA. Cette mesure devient la mesure de référence. Enregistrez cette valeur  $V_{eff}$  dans le tableau ci-dessous et son équivalent en dBm à l'aide de la formule suivante :  $dBm = 10 \times \log_{10}(20 \times V_{eff}^2)$ .

Utiliser	Générateur de signaux				Mesure
	Charge de sortie	Fonction	Amplitude	Fréquence	Résultat mesuré
Q	50 Ω	Sinusoidal	0,354 Veff (3,990 dBm)	1,000 kHz	Veff dBm

4. Définissez la fonction, l'amplitude et la fréquence du générateur de signaux, comme décrit dans le tableau ci-dessous. Mesurez l'amplitude et enregistrez les résultats dans le tableau ci-dessous.

Utiliser	Générateur de signaux				Mesure	
	Charge de sortie	Fonction	Amplitude	Fréquence	Erreur relative à la référence de l'étape 3 (Veff)	Résultat mesuré (Veff)
	50 Ω	Sinusoidal	0,354 Veff	100,000 kHz	±1,15 %	
				500,000 kHz		
				1,000 MHz*		
				5,000 MHz*		
	50 Ω	Sinusoidal	0,354 Veff	10,00 MHz*	±2,92 %	
				20,00 MHz*		

\* Ces valeurs sont utilisées dans le tableau de facteurs de correction ci-dessous.

5. Pour adapter le wattmètre à l'instrument Fluke 5790A, un facteur de correction est calculé à partir du tableau ci-dessous. Des mesures des amplitudes du modèle 5790A et du wattmètre comprises entre 1 MHz et 20 MHz sont utilisées. Entrez les valeurs mesurées pour 1, 5, 10 et 20 MHz et effectuées avec l'instrument Fluke 5790A dans le tableau des facteurs de correction ci-dessous. Utilisez ensuite la formule suivante pour convertir les résultats  $V_{eff}$  en dBm :

$$dBm = 10 \times \log_{10}(20 \times V_{eff}^2)$$

Calculez la moyenne (arithmétique) des quatre résultats dBm et saisissez le résultat dans le tableau au bas de la colonne dBm de l'instrument Fluke 5790A.

6. Connectez le modèle N8482A à la sortie 1 de la voie du générateur de signaux à l'aide d'un connecteur N type, comme illustré ci-dessous. Répétez les mesures 1, 5, 10 et 20 MHz, et saisissez les résultats dBm dans le tableau ci-dessous. Calculez la moyenne (arithmétique) des quatre résultats dBm et saisissez le résultat dans le tableau au bas de la colonne dBm du wattmètre.

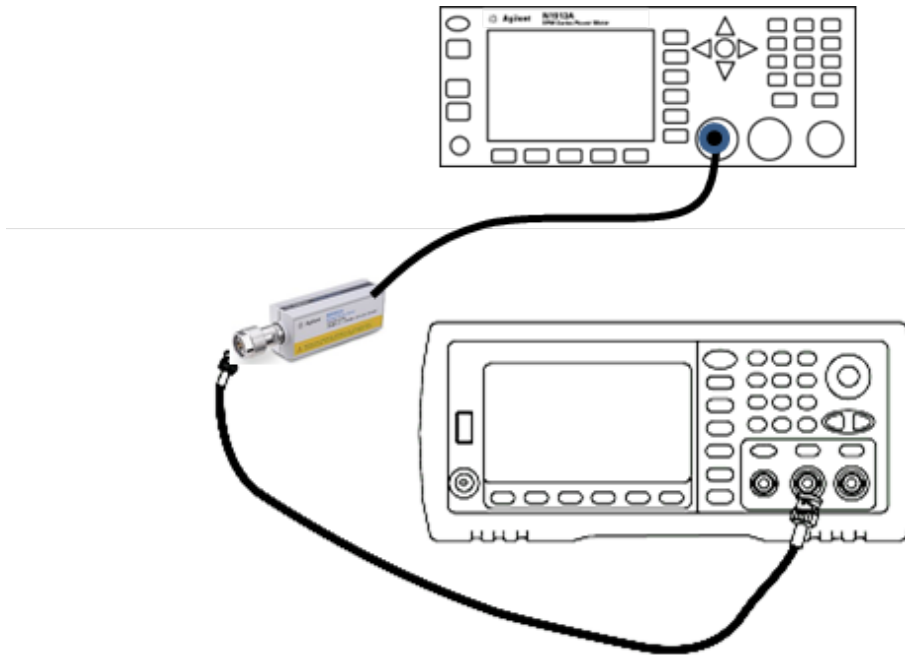

7. Soustrayez la moyenne dBm du wattmètre de la moyenne dBm de l'instrument Fluke 5790A pour calculer le facteur de correction. Enregistrez le résultat dans l'angle inférieur droit du tableau de facteurs de correction. Ajoutez ce facteur de correction à l'ensemble des mesures du wattmètre.

**Tableau de facteurs de correction**

	Fluke 5790A		Wattmètre	
Fréquence	Veff (mesurée)	dBm (voir formule)		dBm (mesuré)
1 MHz				
5 MHz				
10 MHz				
20 MHz				
	<b>Moyenne :</b>		<b>Moyenne :</b>	
<b>Facteur de correction (moyenne du modèle Fluke 5790A moins la moyenne du wattmètre) :</b>				

8. Effectuez les mesures suivantes à l'aide du wattmètre. Réglez l'instrument série 33600 sur la fonction, l'amplitude et les fréquences indiquées ci-dessous. Enregistrez la valeur dBm mesurée (en n'oubliant pas d'ajouter le facteur de correction) pour chaque fréquence dans le tableau ci-dessous.

Utiliser	Générateur de signaux				Mesure		
	Charge de sortie	Fonction	Amplitude	Fréquence	Erreur relative à la référence de l'étape 3	Résultat mesuré (dBm)	Résultat corrigé (dBm)
	50 $\Omega$	Sinusoïdal	0,354 V <sub>eff</sub>	30,00 MHz	±0,20 dB		
				40,00 MHz			
				50,00 MHz			
				60,00 MHz			
	50 $\Omega$	Sinusoïdal	0,354 V <sub>eff</sub>	70,00 MHz	±0,30 dB		
				80,00 MHz			
	50 $\Omega$	Sinusoïdal	0,354 V <sub>eff</sub>	90,00 MHz	±0,40 dB		
				100,00 MHz			
				110,00 MHz			
				120,00 MHz			

9. Comparez les valeurs mesurées aux limites de test indiquées dans les deux tableaux.
10. Instruments 2 voies uniquement : Connectez le voltmètre CA à la voie 2 et répétez les opérations 2 à 6.

[Rubrique d'étalonnage précédente](#)   [Rubrique d'étalonnage suivante](#)

### Vérification de la planéité dans la plage 4 V<sub>pp</sub> - Série 33600

Vérifie la planéité de l'amplitude CA haute fréquence dans la plage 4 V<sub>pp</sub>.

1. Connectez un voltmètre CA de précision pour mesurer l'amplitude de sortie, comme indiqué ci-dessous. Connectez le câble BNC à l'entrée large bande de l'instrument Fluke 5790A. Si vous utilisez un matériel de test de remplacement, vérifiez que l'impédance d'entrée est égale à 50  $\Omega$ , car la précision de la charge affecte directement la qualité des mesures.



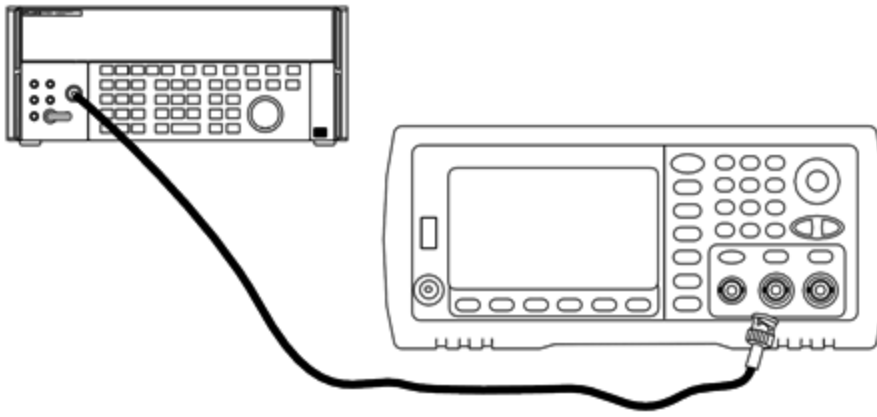

2. Réglez le voltmètre CA de précision sur « Intermédiaire, Intermédiaire » Filtre numérique et Redémarrage filtre.
3. Réglez l'impédance de sortie sur 50 Ω et vérifiez que la sortie est activée. Configurez l'instrument comme décrit dans le tableau ci-dessous et mesurez l'amplitude de sortie à l'aide du voltmètre CA. Cette mesure devient la mesure de référence. Enregistrez cette valeur  $V_{eff}$  dans le tableau ci-dessous et son équivalent en dBm à l'aide de la formule suivante :  $dBm = 10 \times \log_{10}(20 \times V_{eff}^2)$ .

Utiliser	Générateur de signaux				Mesure
	Charge de sortie	Fonction	Amplitude	Fréquence	Résultat mesuré
Q	50 Ω	Sinusoidal	1,414 $V_{eff}$ (16,019 dBm)	1,000 kHz	$V_{eff}$ dBm

4. Définissez la fonction, l'amplitude et la fréquence du générateur de signaux, comme décrit dans le tableau ci-dessous. Mesurez l'amplitude et enregistrez les résultats dans le tableau ci-dessous.

Utiliser	Générateur de signaux				Mesure	
	Charge de sortie	Fonction	Amplitude	Fréquence	Erreur relative à la référence de l'étape 3 (Veff)	Résultat mesuré (Veff)
	50 Ω	Sinusoïdal	1,414 Veff	100,000 kHz	±1,15 %	
				500,000 kHz		
				1,000 MHz*		
				5,000 MHz*		
	50 Ω	Sinusoïdal	1,414 Veff	10,00 MHz*	±2,92 %	
				20,00 MHz*		

\* Ces valeurs sont utilisées dans le tableau de facteurs de correction ci-dessous.

5. Pour adapter le wattmètre à l'instrument Fluke 5790A, un facteur de correction est calculé à partir du tableau ci-dessous. Des mesures des amplitudes du modèle 5790A et du wattmètre comprises entre 1 MHz et 20 MHz sont utilisées. Entrez les valeurs mesurées pour 1, 5, 10 et 20 MHz et effectuées avec l'instrument Fluke 5790A dans le tableau des facteurs de correction ci-dessous. Utilisez ensuite la formule suivante pour convertir les résultats Veff en dBm :

$$\text{dBm} = 10 \times \log_{10}(20 \times V_{\text{eff}}^2)$$

Calculez la moyenne (arithmétique) des quatre résultats dBm et saisissez le résultat dans le tableau au bas de la colonne dBm de l'instrument Fluke 5790A.

- Connectez le modèle N8482A à la sortie 1 de la voie du générateur de signaux à l'aide d'un connecteur N type, comme illustré ci-dessous. Répétez les mesures 1, 5, 10 et 20 MHz, et saisissez les résultats dBm dans le tableau ci-dessous. Calculez la moyenne (arithmétique) des quatre résultats dBm et saisissez le résultat dans le tableau au bas de la colonne dBm du wattmètre.

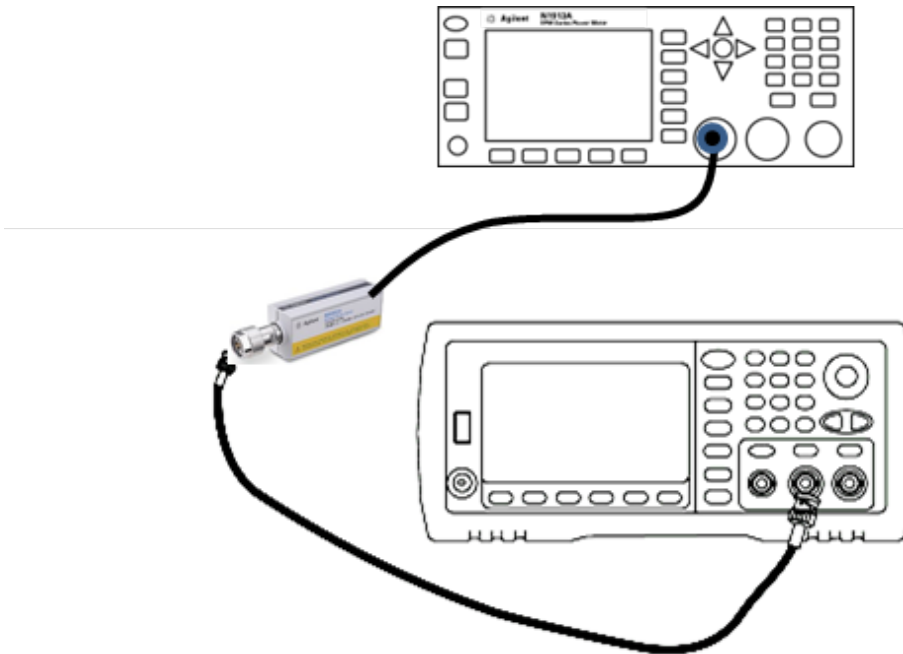

- Soustrayez la moyenne dBm du wattmètre de la moyenne dBm de l'instrument Fluke 5790A pour calculer le facteur de correction. Enregistrez le résultat dans l'angle inférieur droit du tableau de facteurs de correction. Ajoutez ce facteur de correction à l'ensemble des mesures du wattmètre.

**Tableau de facteurs de correction**

Fréquence	Fluke 5790A		Wattmètre	
	Veff (mesurée)	dBm (voir formule)		dBm (mesuré)
1 MHz				
5 MHz				
10 MHz				
20 MHz				
	<b>Moyenne :</b>		<b>Moyenne :</b>	
<b>Facteur de correction (moyenne du modèle Fluke 5790A moins la moyenne du wattmètre) :</b>				

8. Effectuez les mesures suivantes à l'aide du wattmètre. Réglez l'instrument série 33600 sur la fonction, l'amplitude et les fréquences indiquées ci-dessous. Enregistrez la valeur dBm mesurée (en n'oubliant pas d'ajouter le facteur de correction) pour chaque fréquence dans le tableau ci-dessous.

Utiliser	Générateur de signaux				Mesure		
	Charge de sortie	Fonction	Amplitude	Fréquence	Erreur relative à la référence de l'étape 3	Résultat mesuré (dBm)	Résultat corrigé (dBm)
	50 $\Omega$	Sinusoïdal	1,414 V <sub>eff</sub>	30,00 MHz	$\pm 0,25$ dB		
				40,00 MHz			
				50,00 MHz			
				60,00 MHz			
	50 $\Omega$	Sinusoïdal	1,414 V <sub>eff</sub>	70,00 MHz	$\pm 0,40$ dB		
				80,00 MHz			
	50 $\Omega$	Sinusoïdal	1,414 V <sub>eff</sub>	90,00 MHz	$\pm 0,50$ dB		
				100,00 MHz			
				110,00 MHz			
				120,00 MHz			

9. Comparez les valeurs mesurées aux limites de test indiquées dans les deux tableaux.
10. Instruments 2 voies uniquement : Connectez le voltmètre CA à la voie 2 et répétez les opérations 2 à 6.

[Rubrique d'étalonnage précédente](#)   [Rubrique d'étalonnage suivante](#)

### Vérification de la planéité dans la plage 8 Vpp - Série 33600

Vérifie la planéité de l'amplitude CA haute fréquence dans la plage 8 Vpp.

1. Connectez un voltmètre CA de précision pour mesurer l'amplitude de sortie, comme indiqué ci-dessous. Connectez le câble BNC à l'entrée large bande de l'instrument Fluke 5790A. Si vous utilisez un matériel de test de remplacement, vérifiez que l'impédance d'entrée est égale à 50  $\Omega$ , car la précision de la charge affecte directement la qualité des mesures.

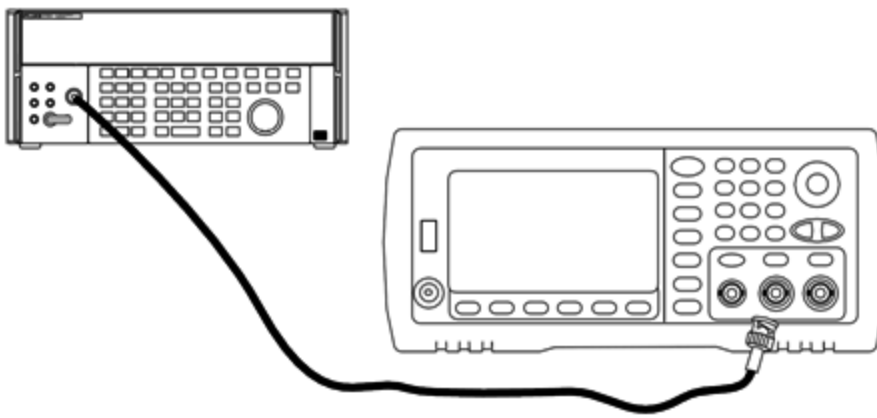

2. Réglez le voltmètre CA de précision sur « Intermédiaire, Intermédiaire » Filtre numérique et Redémarrage filtre.
3. Réglez l'impédance de sortie sur 50 Ω et vérifiez que la sortie est activée. Configurez l'instrument comme décrit dans le tableau ci-dessous et mesurez l'amplitude de sortie à l'aide du voltmètre CA. Cette mesure devient la mesure de référence. Enregistrez cette valeur  $V_{eff}$  dans le tableau ci-dessous et son équivalent en dBm à l'aide de la formule suivante :  $dBm = 10 \times \log_{10}(20 \times V_{eff}^2)$ .

Utiliser	Générateur de signaux				Mesure
	Charge de sortie	Fonction	Amplitude	Fréquence	Résultat mesuré
Q	50 Ω	Sinusoidal	2,828 V <sub>eff</sub> (22,040 dBm)	1,000 kHz	V <sub>eff</sub> dBm

4. Définissez la fonction, l'amplitude et la fréquence du générateur de signaux, comme décrit dans le tableau ci-dessous. Mesurez l'amplitude et enregistrez les résultats dans le tableau ci-dessous.

Utiliser	Générateur de signaux				Mesure	
	Charge de sortie	Fonction	Amplitude	Fréquence	Erreur relative à la référence de l'étape 3 (Veff)	Résultat mesuré (Veff)
	50 Ω	Sinusoïdal	2,828 Veff	100,000 kHz	±1,15 %	
				500,000 kHz		
				1,000 MHz*		
				5,000 MHz*		
	50 Ω	Sinusoïdal	2,828 Veff	10,00 MHz*	±2,92 %	
				20,00 MHz*		

\* Ces valeurs sont utilisées dans le tableau de facteurs de correction ci-dessous.

5. Pour adapter le wattmètre à l'instrument Fluke 5790A, un facteur de correction est calculé à partir du tableau ci-dessous. Des mesures des amplitudes du modèle 5790A et du wattmètre comprises entre 1 MHz et 20 MHz sont utilisées. Entrez les valeurs mesurées pour 1, 5, 10 et 20 MHz et effectuées avec l'instrument Fluke 5790A dans le tableau des facteurs de correction ci-dessous. Utilisez ensuite la formule suivante pour convertir les résultats Veff en dBm :

$$\text{dBm} = 10 \times \log_{10}(20 \times V_{\text{eff}}^2)$$

Calculez la moyenne (arithmétique) des quatre résultats dBm et saisissez le résultat dans le tableau au bas de la colonne dBm de l'instrument Fluke 5790A.

6. Connectez le modèle N8482A à la sortie 1 de la voie du générateur de signaux à l'aide d'un connecteur N type, comme illustré ci-dessous. Répétez les mesures 1, 5, 10 et 20 MHz, et saisissez les résultats dBm dans le tableau ci-dessous. Calculez la moyenne (arithmétique) des quatre résultats dBm et saisissez le résultat dans le tableau au bas de la colonne dBm du wattmètre.

**ATTENTION** Pour éviter tout endommagement de la sonde de puissance N8482A, assurez-vous d'insérer l'atténuateur 10 à 20 dB en série avec la mesure.

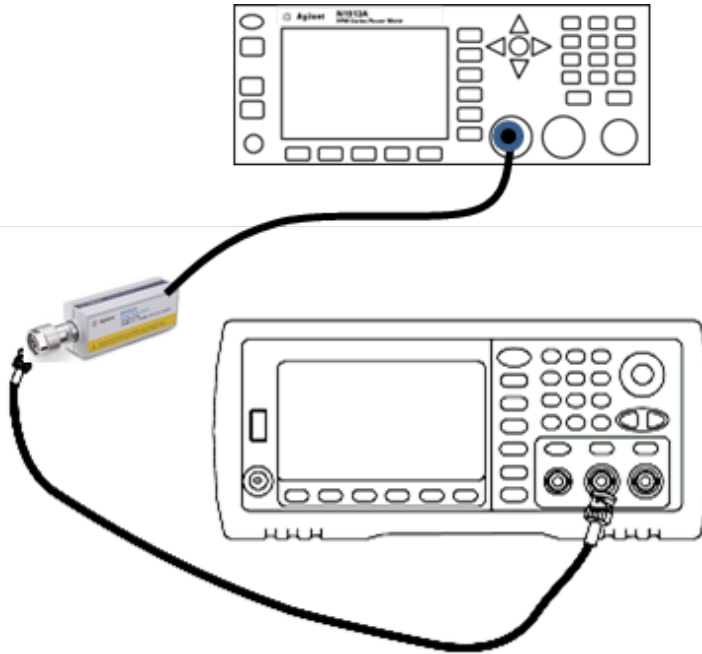

7. Soustrayez la moyenne dBm du wattmètre de la moyenne dBm de l'instrument Fluke 5790A pour calculer le facteur de correction. Enregistrez le résultat dans l'angle inférieur droit du tableau de facteurs de correction. Ajoutez ce facteur de correction à l'ensemble des mesures du wattmètre.

Tableau de facteurs de correction

Fréquence	Fluke 5790A		Wattmètre	
	Veff (mesurée)	dBm (voir formule)		dBm (mesuré)
1 MHz				
5 MHz				
10 MHz				
20 MHz				
	<b>Moyenne :</b>		<b>Moyenne :</b>	
<b>Facteur de correction (moyenne du modèle Fluke 5790A moins la moyenne du wattmètre) :</b>				

8. Effectuez les mesures suivantes à l'aide du wattmètre. Réglez l'instrument série 33600 sur la fonction, l'amplitude et les fréquences indiquées ci-dessous. Enregistrez la valeur dBm mesurée (en n'oubliant pas d'ajouter le facteur de correction) pour chaque fréquence dans le tableau ci-dessous.

Utiliser	Générateur de signaux				Mesure		
	Charge de sortie	Fonction	Amplitude	Fréquence	Erreur relative à la référence de l'étape 3	Résultat mesuré (dBm)	Résultat corrigé (dBm)
	50 $\Omega$	Sinusoïdal	2,828 Veff	30,00 MHz	$\pm 0,25$ dB		
				40,00 MHz			
				50,00 MHz			
				60,00 MHz			
	50 $\Omega$	Sinusoïdal	2,828 Veff	70,00 MHz	$\pm 0,40$ dB		
				80,00 MHz			

9. Comparez les valeurs mesurées aux limites de test indiquées dans les deux tableaux.
10. Instruments 2 voies uniquement : Connectez le voltmètre CA à la voie 2 et répétez les opérations 2 à 6.

[Rubrique d'étalonnage précédente](#)   [Rubrique d'étalonnage suivante](#)



## Procédure générale d'étalonnage/réglage - Série 33600

Méthode recommandée pour l'étalonnage complet de l'instrument :

1. Consultez la section **Considérations relatives aux tests**.
2. **Effectuez les tests de vérification** pour caractériser l'instrument (données entrantes).
3. Appuyez sur [**System > Instr Setup > Calibrate**]. Si la sécurité de l'instrument pour l'étalonnage est verrouillée, **déverrouillez-la**.
4. Entrez le numéro du réglage de la procédure en cours. Le numéro par défaut est « 1 » ; sur la face avant, ce numéro est incrémenté à mesure que les procédures sont exécutées.
5. Sélectionnez **BEGIN**.
6. Pour les réglages qui nécessitent une entrée, réglez la valeur affichée avec la valeur mesurée et sélectionnez **ENTER VALUE**.
7. La configuration passe automatiquement à la valeur suivante nécessaire.

Pour annuler la procédure de réglage, sélectionnez **CANCEL STEP**. L'écran revient à la saisie du numéro de réglage.

8. Lorsque vous avez terminé, sélectionnez **END CAL**.
9. (Option) Configurez un nouveau message d'étalonnage via l'interface distante. Ce message (contenant jusqu'à 40 caractères) est enregistré avec les coefficients d'étalonnage.
10. Verrouillez la sécurité d'étalonnage du multimètre.
11. Notez le nouveau code de sécurité et le nombre de points d'étalonnage figurant dans les dossiers de maintenance de l'instrument.

[Rubrique d'étalonnage précédente](#)   [Rubrique d'étalonnage suivante](#)

## Abandon d'un étalonnage en cours - Série 33600

Il est parfois nécessaire d'abandonner un étalonnage en cours. Vous pouvez abandonner un étalonnage à tout moment : mettez l'instrument hors tension ou, sur l'interface distante, envoyez un message d'effacement de l'appareil suivi de la commande **\*RST**.

L'instrument enregistre les constantes d'étalonnage à la fin de chaque procédure d'étalonnage. Si l'alimentation est coupée ou si un réglage en cours est abandonné pour une raison quelconque, il suffit d'exécuter à nouveau la procédure de réglage interrompue.

### ATTENTION

Si l'alimentation est coupée lorsque l'instrument écrit en mémoire de nouvelles constantes d'étalonnage, vous pouvez perdre toutes les constantes d'étalonnage de la fonction. Généralement, lorsque vous remettez l'instrument sous tension, celui-ci génère l'erreur **"-313, Calibration Memory Lost"**.

[Rubrique d'étalonnage précédente](#)   [Rubrique d'étalonnage suivante](#)

## Ordre des réglages - Série 33600

L'ordre des réglages dans les opérations numérotées minimise le nombre de réglages du matériel de test et de modifications des connexions.

Vous pouvez effectuer des réglages séparés si nécessaire, mais les opérations 1 à 7 doivent être exécutées dans cet ordre avant toute autre procédure de réglage.

[Rubrique d'étalonnage précédente](#) [Rubrique d'étalonnage suivante](#)

### Autotest - Série 33600

Exécutez l'autotest pour vous assurer que l'instrument fonctionne correctement avant d'effectuer tout autre réglage.

Assurez-vous de déverrouiller l'instrument et de respecter les consignes contenues dans la section [Considérations relatives aux tests](#) avant de commencer un réglage.

1. Appuyez sur **[System > Instr Setup > Calibrate]**. Entrez le numéro de réglage 1 et sélectionnez **BEGIN**.

Réglage	
1	Exécutez l'autotest. La sortie principale est désactivée pendant le test.

2. Si l'instrument échoue à l'autotest, vous devez le réparer avant de poursuivre les procédures de réglage.

Un autotest complet (**\*TST?**) dure environ 15 secondes.

[Rubrique d'étalonnage précédente](#) [Rubrique d'étalonnage suivante](#)

### Réglage de la fréquence (base de temps interne) - Série 33600

L'instrument enregistre une constante d'étalonnage qui règle l'oscillateur à quartz sur la fréquence exacte de 10 MHz. L'instrument doit avoir fonctionné en permanence pendant 30 minutes avant cet étalonnage afin de garantir la stabilité de la base de temps

1. Configurez la résolution du fréquencemètre à moins de 0,01 ppm et la terminaison d'entrée à 50  $\Omega$  (si votre fréquencemètre n'est pas équipé d'une terminaison d'entrée de 50  $\Omega$ , vous devez fournir une terminaison externe). Effectuez les connexions indiquées ci-dessous.

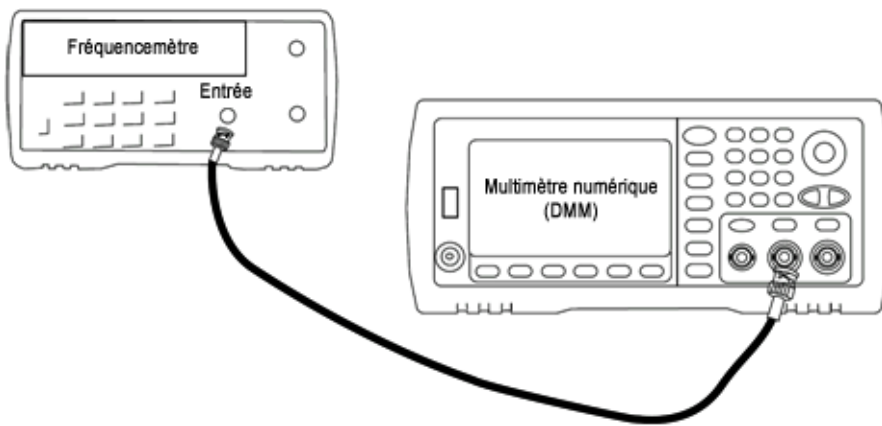

2. Utilisez le fréquencemètre pour mesurer la fréquence de sortie de chaque réglage figurant dans le tableau suivant.

Réglage	Signal nominal		
	Fréquence	Amplitude	
2	<10 MHz	~1 Vpp	La fréquence de sortie est légèrement inférieure à 10 MHz
3	>10 MHz		La fréquence de sortie est légèrement supérieure à 10 MHz
4	~10 MHz		La fréquence de sortie doit être proche de 10 MHz
5*	10 MHz		La fréquence de sortie doit être de 10 MHz ± 1 ppm

\* Les constantes sont enregistrées après cette configuration.

3. À l'aide du clavier numérique ou du bouton, réglez la fréquence affichée pour chaque réglage sur la fréquence mesurée. Sélectionnez **ENTER VALUE**.
4. Ensuite :
- Si vos procédures d'étalonnage requièrent la vérification du réglage qui vient d'être effectué, quittez le menu d'étalonnage et procédez à la **Vérification de la base de temps interne**.
  - Si vous effectuez tous les réglages sur un instrument 2 voies et vérifiez ensuite le fonctionnement de l'instrument, passez à la procédure suivante de cette section.

[Rubrique d'étalonnage précédente](#)   [Rubrique d'étalonnage suivante](#)

### Réglage du convertisseur analogique/numérique (ADC) interne - Série 33600

L'instrument enregistre les constantes d'étalonnage pour le gain et la tension résiduelle du convertisseur analogique/numérique (ADC) interne. L'opération 8 doit toujours être effectuée avant tout autre réglage de l'amplitude. Le convertisseur analogique/numérique interne est alors utilisé comme source pour les constantes d'étalonnage générées lors de l'auto-étalonnage (opération 9). (Réglage 6 and Réglage 7 are not used.)

1. Connectez la sortie de la voie 1 aux connecteurs Modulation Input et DMM de la face arrière, comme indiqué ci-dessous.

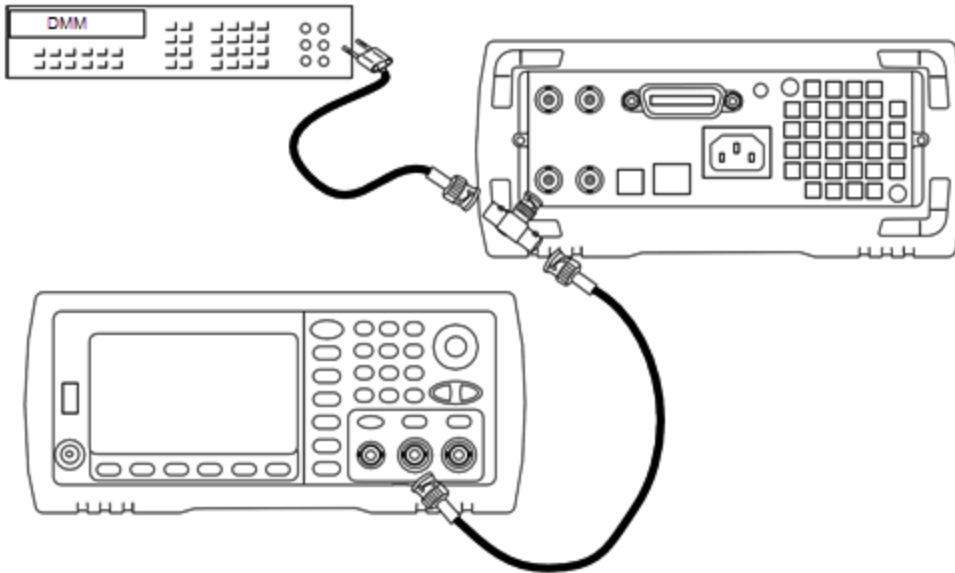

2. Réglez le voltmètre numérique pour afficher 5 chiffres et demi et mesurer les tensions continues (Vcc).
3. Entrez le réglage suivant.

	Signal nominal	
Réglage	Niveau CC	
8*	$\sim 1,1 V_{cc} \pm 10 \%$	Étalonne le convertisseur analogique/numérique interne.

\* Les constantes sont enregistrées après cette configuration.

4. Entrez la valeur mesurée sur le voltmètre numérique à l'aide du clavier numérique ou du bouton.

**REMARQUE** Cette configuration dure environ 15 secondes.

5. Débranchez tous les câbles de l'instrument.

[Rubrique d'étalonnage précédente](#)   [Rubrique d'étalonnage suivante](#)

### Réglage de l'auto-étalonnage - Série 33600

1. Entrez le réglage suivant.

Réglage	
9*	Auto-étalonnage. La sortie est désactivée.

\* Les constantes sont enregistrées après cette configuration.

2. Ensuite :

## Entretien et réparation - Introduction

- a. Si vos procédures d'étalonnage requièrent la vérification du réglage qui vient d'être effectué, quittez le menu d'étalonnage et procédez à la **vérification de la tension CC résiduelle**.
- b. Si vous effectuez tous les réglages sur un instrument 2 voies et vérifiez ensuite le fonctionnement de l'instrument, passez à la procédure suivante de cette section.

**REMARQUE** Cette configuration dure environ 15 secondes.

[Rubrique d'étalonnage précédente](#) [Rubrique d'étalonnage suivante](#)

### Réglage de l'impédance de sortie - Série 33600

L'instrument enregistre les constantes d'étalonnage de l'impédance de sortie des voies. Ces constantes sont générées avec et sans atténuateur de post-amplification.

1. Réglez le multimètre numérique pour mesurer des résistances à décalage compensé sur 4 fils. Réglez le multimètre numérique pour utiliser l'intégration 100 NPLC. Connectez les entrées Ohms Source et Ohms Sense du multimètre numérique à la sortie de la voie, comme illustré ci-dessous.

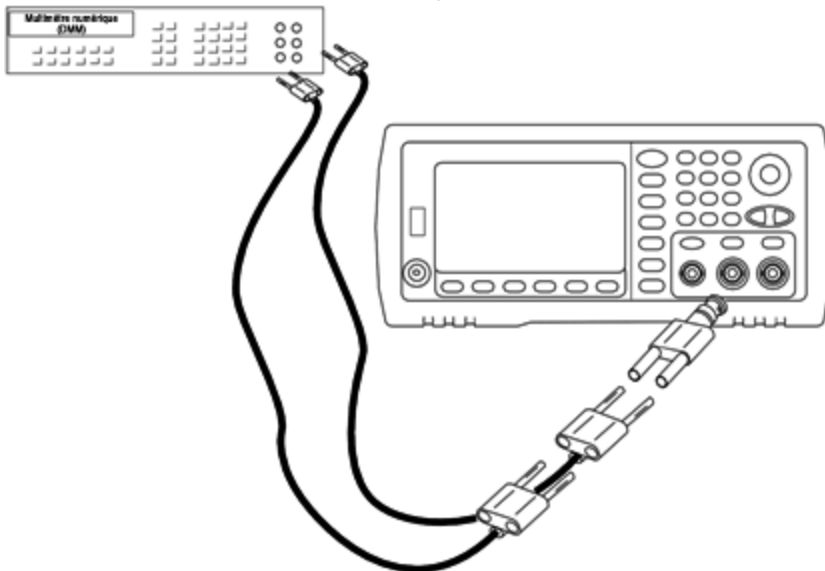

2. Utilisez le multimètre numérique pour mesurer une résistance sur 4 fils sur le connecteur de la face avant pour chaque réglage figurant dans le tableau suivant. La valeur mesurée attendue est approximativement de 50  $\Omega$ .

Réglage	
10*	Amplificateur à couplage direct
11*	Amplificateur plus filtre 100 MHz
12*	Amplificateur plus filtre 150 MHz
13*	Post-atténuateur 24 dB
14*	Post-atténuateur 24 dB plus filtre 150 MHz

\* Les constantes sont enregistrées après cette configuration.

3. À l'aide du clavier numérique ou du bouton, réglez l'impédance affichée pour chaque réglage sur l'impédance mesurée. Sélectionnez **ENTER VALUE**.
4. Il n'existe pas de test de vérification du fonctionnement pour l'impédance de sortie. Passez à la procédure de réglage suivante de cette section.

[Rubrique d'étalonnage précédente](#) [Rubrique d'étalonnage suivante](#)

### Réglage de l'amplitude CA (haute impédance) - Série 33600

L'instrument enregistre une constante d'étalonnage pour chaque voie de propagation vers l'atténuateur haute impédance. Le coefficient du gain de la propagation est calculé avec deux mesures : une avec le convertisseur N/A du signal sur la sortie + et l'autre avec le convertisseur N/A sur la sortie -. Par conséquent, les réglages doivent être effectués deux par deux.

1. Connectez le multimètre numérique à la sortie de la voie, comme indiqué ci-dessous.

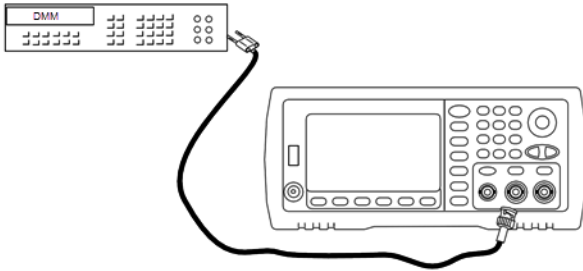

2. Utilisez le multimètre numérique pour mesurer la tension CC sur le connecteur de la face avant pour chaque réglage figurant dans le tableau suivant.

Réglage	Signal nominal	
	Niveau CC	
15	+0,0028 V	Sortie dans la plage -72 dB
16*	-0,0028 V	Sortie dans la plage -72 dB
17	+0,0068 V	Sortie dans la plage -64 dB
18*	-0,0068 V	Sortie dans la plage -64 dB
19	+0,0170 V	Sortie dans la plage -56 dB
20*	-0,0170 V	Sortie dans la plage -56 dB
21	+0,0430 V	Sortie dans la plage -48 dB
22*	-0,0430 V	Sortie dans la plage -48 dB
23	+0,1060 V	Sortie dans la plage -40 dB
24*	-0,1060 V	Sortie dans la plage -40 dB
25	+0,2680 V	Sortie dans la plage -32 dB
26*	-0,2680 V	Sortie dans la plage -32 dB
27	+0,6600 V	Sortie dans la plage -24 dB
28*	-0,6600 V	Sortie dans la plage -24 dB
29	+1,6500 V	Sortie dans la plage -16 dB
30*	-1,6500 V	Sortie dans la plage -16 dB
31	+4,2000 V	Sortie dans la plage -8 dB
32*	-4,2000 V	Sortie dans la plage -8 dB
33	+10,4000 V	Sortie dans la plage 0 dB
34*	-10,4000 V	Sortie dans la plage 0 dB
35	+0,0430 V	Sortie dans la plage CC haute -48 dB
36*	-0,0430V	Sortie dans la plage CC haute -48 dB
37	+0,1060 V	Sortie dans la plage CC haute -40 dB
38*	-0,1060 V	Sortie dans la plage CC haute -40 dB
39	+0,2680 V	Sortie dans la plage CC haute -32 dB

Réglage	Signal nominal	
	Niveau CC	
40*	-0,2680 V	Sortie dans la plage CC haute -32 dB
41	+0,6600 V	Sortie dans la plage CC haute -24 dB
42*	-0,6600 V	Sortie dans la plage CC haute -24 dB

\* Les constantes sont enregistrées après cette configuration.

3. À l'aide du clavier numérique ou du bouton, réglez la tension affichée pour chaque réglage sur la tension mesurée. Sélectionnez **ENTER VALUE**.
4. Ensuite :
  - a. Si vos procédures d'étalonnage requièrent la vérification de ce réglage, quittez le menu d'étalonnage et procédez à la **vérification de l'amplitude CA (haute impédance)**.
  - b. Si vous effectuez tous les réglages sur un instrument 2 voies et vérifiez ensuite le fonctionnement de l'instrument, passez à la procédure suivante de cette section.

[Rubrique d'étalonnage précédente](#)   [Rubrique d'étalonnage suivante](#)

### Réglage de la planéité 1 Vpp - Série 33600

1. Pour les fréquences atteignant 20 MHz, connectez un voltmètre CA de précision pour mesurer l'amplitude de sortie, comme indiqué ci-dessous. Connectez le câble BNC à l'entrée large bande de l'instrument Fluke 5790A.

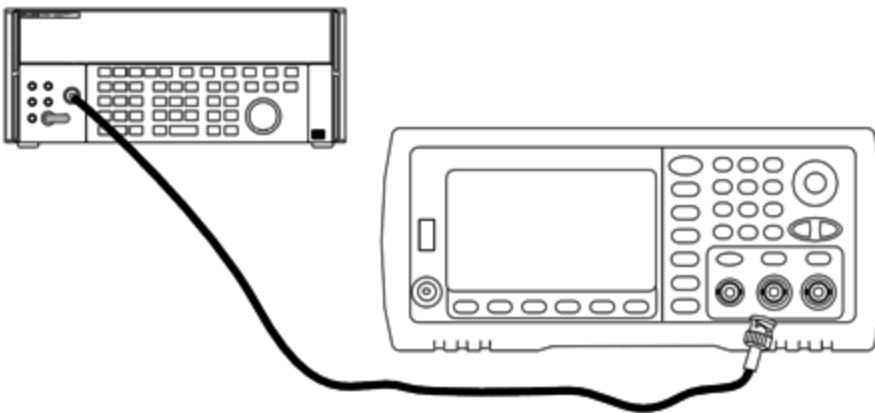

Pour les fréquences supérieures à 20 MHz, connectez un wattmètre et une sonde de puissance de précision pour mesurer l'amplitude de sortie, comme indiqué ci-dessous.



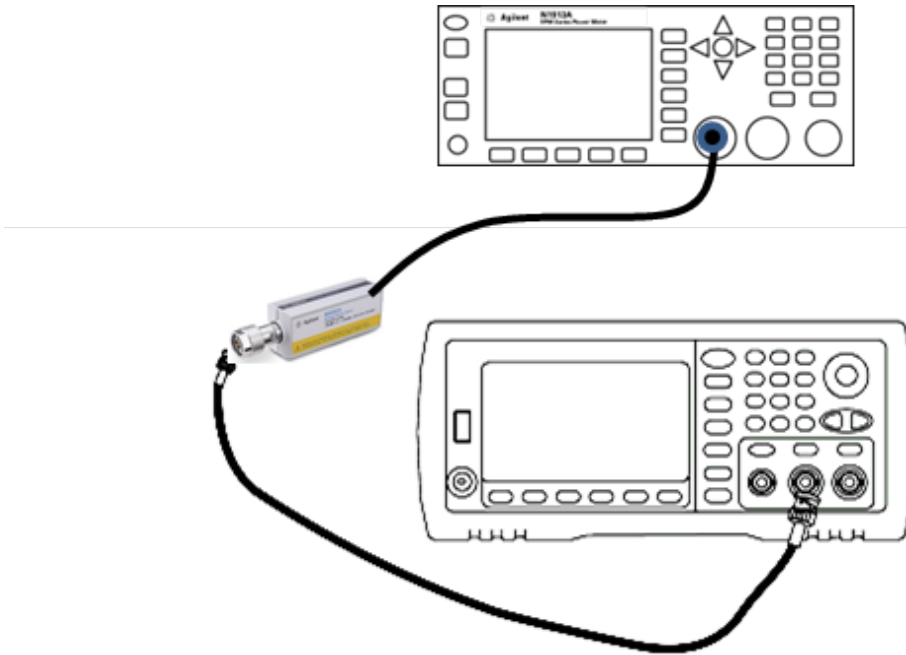

2. Utilisez le voltmètre CA de précision pour mesurer l'amplitude de sortie de chaque réglage figurant dans le tableau ci-dessous.

Réglage	Signal nominal		
	Fréquence	Amplitude	
43*	1 kHz	380 mVeff	Planéité dans la plage 1 Vpp
44*	100 kHz		
45*	1 MHz		
46*	5 MHz		
47*	10 MHz		
48*	20 MHz		
49*	25 MHz		
50*	30 MHz		
51	40 MHz		
52	50 MHz		
53	60 MHz		
54	70 MHz		
55	80 MHz		
56	90 MHz		
57	100 MHz		
58	110 MHz		
59	120 MHz		

\* Les constantes sont enregistrées après cette configuration.

3. À l'aide du clavier numérique ou du bouton, réglez la tension affichée pour chaque réglage sur la tension mesurée. Sélectionnez **ENTER VALUE**.
4. Ensuite :
- Si vos procédures d'étalonnage requièrent la vérification du réglage qui vient d'être effectué, quittez le menu d'étalonnage et procédez à la **Vérification de la planéité dans la plage 1 Vpp**.
  - Si vous effectuez tous les réglages sur un instrument 2 voies et vérifiez ensuite le fonctionnement de l'instrument, passez à la procédure suivante de cette section.

[Rubrique d'étalonnage précédente](#)   [Rubrique d'étalonnage suivante](#)

## Réglage de la planéité 4 Vpp - Série 33600

1. Pour les fréquences atteignant 20 MHz, connectez un voltmètre CA de précision pour mesurer l'amplitude de sortie, comme indiqué ci-dessous. Connectez le câble BNC à l'entrée large bande de l'instrument Fluke 5790A.

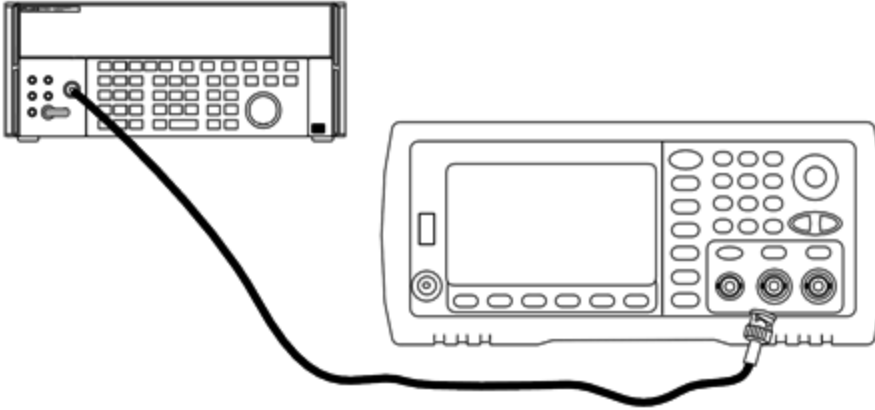

Pour les fréquences supérieures à 20 MHz, connectez un wattmètre et une sonde de puissance de précision pour mesurer l'amplitude de sortie, comme indiqué ci-dessous.

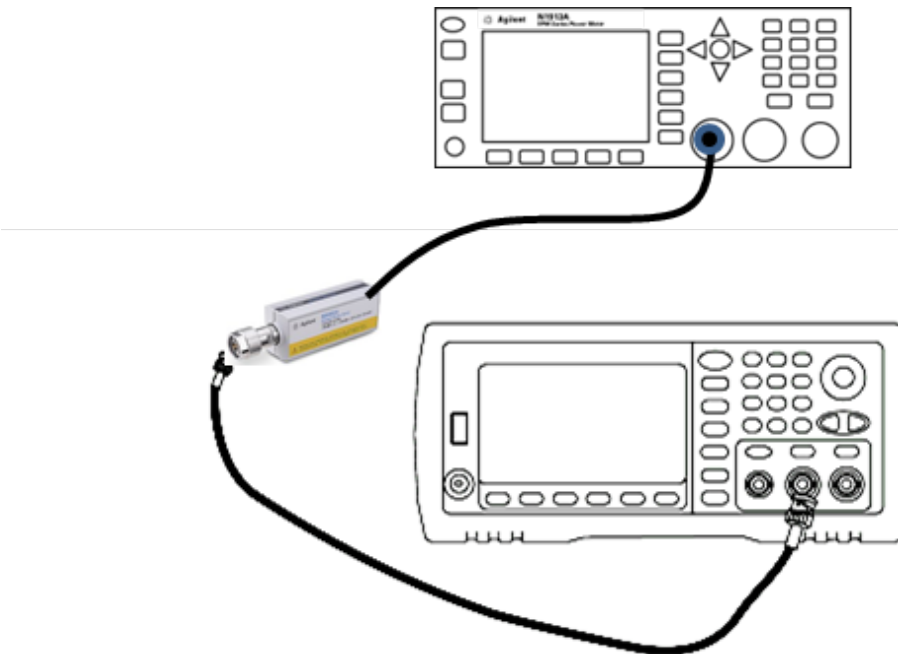

2. Utilisez le voltmètre CA de précision pour mesurer l'amplitude de sortie de chaque réglage figurant dans le tableau ci-dessous.

Réglage	Signal nominal		
	Fréquence	Amplitude	
60*	1 kHz	960 mVeff	Planéité de la plage -8 dB
61*	100 kHz		
62*	1 MHz		
63*	5 MHz		
64*	10 MHz		
65*	20 MHz		
66*	25 MHz		
67*	30 MHz		
68	40 MHz		
69	50 MHz		
70	60 MHz		
71	70 MHz		
72	80 MHz		
73	90 MHz		
74	100 MHz		
75	110 MHz		
76	120 MHz		

\* Les constantes sont enregistrées après cette configuration.

3. À l'aide du clavier numérique ou du bouton, réglez la tension affichée pour chaque réglage sur la tension mesurée. Sélectionnez **ENTER VALUE**.
4. Ensuite :
  - a. Si vos procédures d'étalonnage requièrent la vérification du réglage qui vient d'être effectué, quittez le menu d'étalonnage et procédez à la **Vérification de la planéité dans la plage 4 Vpp**.
  - b. Si vous effectuez les réglages et vérifiez ensuite le fonctionnement de l'instrument, vérifiez les spécifications de sortie en effectuant les **tests de vérification des performances**.

Les procédures de réglage d'un instrument 1 voie sont à présent terminées. Une vérification des spécifications de sortie est recommandée.

Si vous effectuez les réglages sur un instrument 2 voies, passez à la procédure suivante de cette section.

[Rubrique d'étalonnage précédente](#) [Rubrique d'étalonnage suivante](#)

## Réglage de la planéité 8 Vpp - Série 33600

1. Pour les fréquences atteignant 20 MHz, connectez un voltmètre CA de précision pour mesurer l'amplitude de sortie, comme indiqué ci-dessous. Connectez le câble BNC à l'entrée large bande de l'instrument Fluke 5790A.

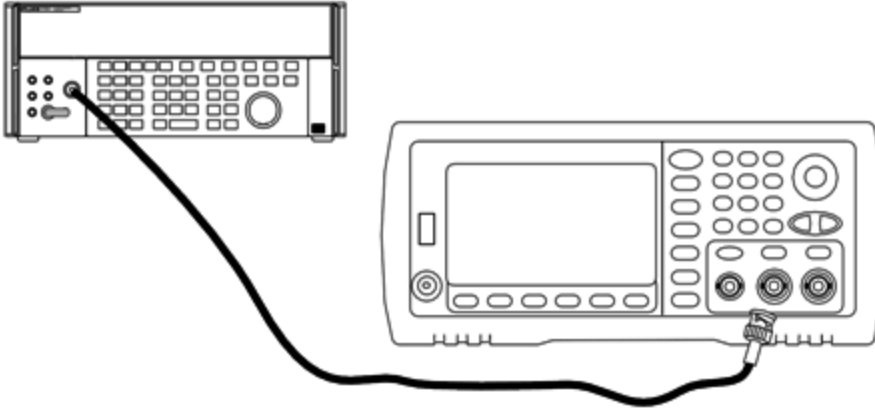

Pour les fréquences supérieures à 20 MHz, connectez un wattmètre et une sonde de puissance de précision pour mesurer l'amplitude de sortie, comme indiqué ci-dessous.

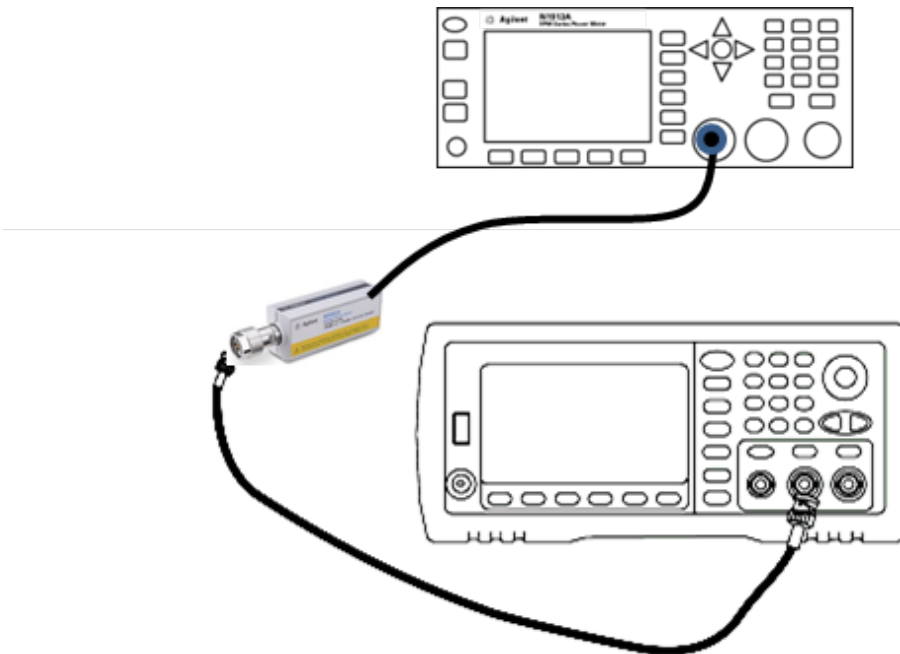

2. Utilisez le voltmètre CA de précision pour mesurer l'amplitude de sortie de chaque réglage figurant dans le tableau ci-dessous.

Réglage	Signal nominal		
	Fréquence	Amplitude	
77*	1 kHz	2,4 V <sub>eff</sub>	Planéité dans la plage 0 dB
78*	100 kHz		
79*	1 MHz		
80*	5 MHz		
81*	10 MHz		
82*	20 MHz		
83*	25 MHz		
84*	30 MHz		
85	40 MHz		
86	50 MHz		
87	60 MHz		
88	70 MHz		
89	80 MHz		

\* Les constantes sont enregistrées après cette configuration.

3. À l'aide du clavier numérique ou du bouton, réglez la tension affichée pour chaque réglage sur la tension mesurée. Sélectionnez **ENTER VALUE**.
4. Ensuite :
  - a. Si vos procédures d'étalonnage requièrent la vérification du réglage qui vient d'être effectué, quittez le menu d'étalonnage et procédez à la **Vérification de la planéité dans la plage 8 Vpp**.
  - b. Si vous effectuez les réglages et vérifiez ensuite le fonctionnement de l'instrument, vérifiez les spécifications de sortie en effectuant les **tests de vérification des performances**.

Les procédures de réglage d'un instrument 1 voie sont à présent terminées. Une vérification des spécifications de sortie est recommandée.

Si vous effectuez les réglages sur un instrument 2 voies, passez à la procédure suivante de cette section.

[Rubrique d'étalonnage précédente](#) [Rubrique d'étalonnage suivante](#)

## Réglages de la voie 2 - Série 33600

Les rubriques suivantes décrivent les réglages d'étalonnage de la voie 2.

- [Réglage de l'auto-étalonnage \(voie 2\)](#)
- [Réglage de l'impédance de sortie \(voie 2\)](#)

- Réglage de l'amplitude CA (haute impédance) (voie 2)
- Réglage de la planéité dans la plage -16 dB (voie 2)
- Réglage de la planéité dans la plage -8 dB (voie 2)
- Réglage de la planéité dans la plage 0 dB

[Rubrique d'étalonnage précédente](#)   [Rubrique d'étalonnage suivante](#)

### Réglage de l'auto-étalonnage (voie 2) - Série 33600

1. Entrez le réglage suivant.

Réglage	
90*	Auto-étalonnage. La sortie est désactivée.

\* Les constantes sont enregistrées après cette configuration.

2. Ensuite :

- a. Si vos procédures d'étalonnage requièrent la vérification du réglage qui vient d'être effectué, quittez le menu d'étalonnage et procédez à la **vérification de la tension CC résiduelle**. Assurez-vous d'effectuer cette opération pour la voie 2.
- b. Si vous effectuez tous les réglages sur un instrument 2 voies et vérifiez ensuite le fonctionnement de l'instrument, passez à la procédure suivante de cette section.

**REMARQUE**

Cette configuration dure environ 15 secondes.

[Rubrique d'étalonnage précédente](#)   [Rubrique d'étalonnage suivante](#)

### Réglage de l'impédance de sortie (voie 2) - Série 33600

L'instrument enregistre les constantes d'étalonnage de l'impédance de sortie des voies. Ces constantes sont générées avec et sans atténuateur de post-amplification.

1. Réglez le multimètre numérique pour mesurer des résistances à décalage compensé sur 4 fils. Réglez le multimètre numérique pour utiliser l'intégration 100 NPLC. Connectez les entrées Ohms Source et Ohms Sense du multimètre numérique à la sortie de la voie, comme illustré ci-dessous.

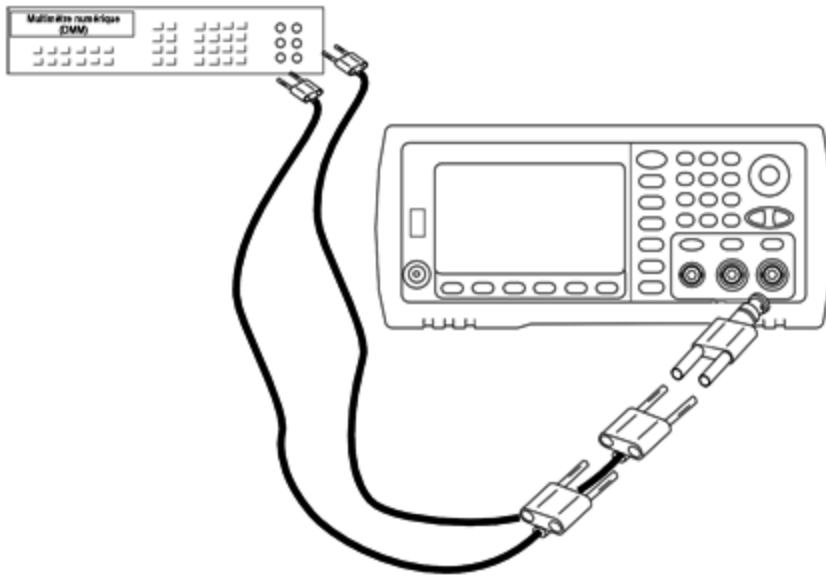

2. Utilisez le multimètre numérique pour mesurer une résistance sur 4 fils sur le connecteur de la face avant pour chaque réglage figurant dans le tableau suivant. La valeur mesurée attendue est approximativement de  $50 \Omega$ .

Réglage	
91*	Amplificateur à couplage direct
92*	Amplificateur plus filtre 100 MHz
93*	Amplificateur plus filtre 150 MHz
94*	Post-atténuateur 24 dB
95*	Post-atténuateur 24 dB plus filtre 150 MHz

3.

\* Les constantes sont enregistrées après cette configuration.

4. À l'aide du clavier numérique ou du bouton, réglez l'impédance affichée pour chaque réglage sur l'impédance mesurée. Sélectionnez **ENTER VALUE**.
5. Il n'existe pas de test de vérification du fonctionnement pour l'impédance de sortie. Passez à la procédure de réglage suivante de cette section.

[Rubrique d'étalonnage précédente](#) [Rubrique d'étalonnage suivante](#)

### Réglage de l'amplitude CA (haute impédance) (voie 2) - Série 33600

L'instrument enregistre une constante d'étalonnage pour chaque voie de propagation vers l'atténuateur haute impédance. Le coefficient du gain de la propagation est calculé avec deux mesures : une avec le convertisseur N/A du signal sur la sortie + et l'autre avec le convertisseur N/A sur la sortie -. Par conséquent, les réglages doivent être effectués deux par deux.



1. Connectez le multimètre numérique à la sortie de la voie, comme indiqué ci-dessous.

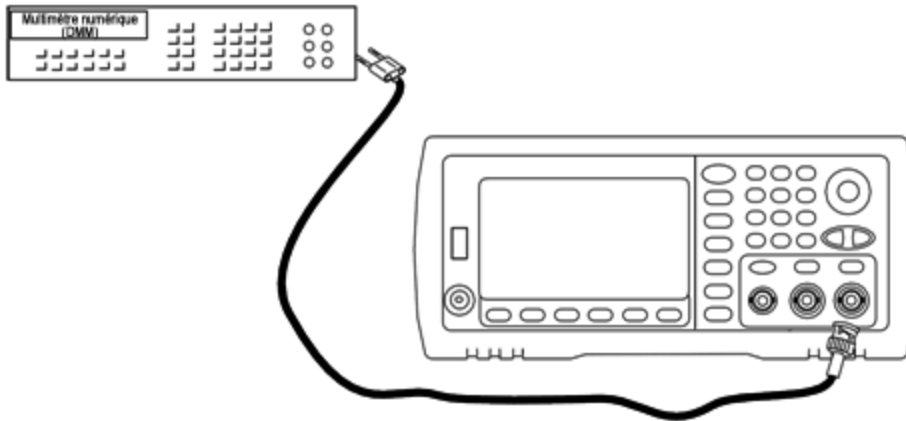

2. Utilisez le multimètre numérique pour mesurer la tension CC sur le connecteur de la face avant pour chaque réglage figurant dans le tableau suivant.

Réglage	Signal nominal	
	Niveau CC	
96	+0,0028 V	Sortie dans la plage -72 dB
97*	-0,0028 V	Sortie dans la plage -72 dB
98	+0,0068 V	Sortie dans la plage -64 dB
99*	-0,0068 V	Sortie dans la plage -64 dB
100	+0,0170 V	Sortie dans la plage -56 dB
101*	-0,0170 V	Sortie dans la plage -56 dB
102	+0,0430 V	Sortie dans la plage -48 dB
103*	-0,0430 V	Sortie dans la plage -48 dB
104	+0,1060 V	Sortie dans la plage -40 dB
105*	-0,1060 V	Sortie dans la plage -40 dB
106	+0,2680 V	Sortie dans la plage -32 dB
107*	-0,2680 V	Sortie dans la plage -32 dB
108	+0,6600 V	Sortie dans la plage -24 dB
109*	-0,6600 V	Sortie dans la plage -24 dB
110	+1,6500 V	Sortie dans la plage -16 dB
111*	-1,6500 V	Sortie dans la plage -16 dB
112	+4,2000 V	Sortie dans la plage -8 dB

Réglage	Signal nominal	
	Niveau CC	
113*	-4,2000 V	Sortie dans la plage -8 dB
114	+10,4000 V	Sortie dans la plage 0 dB
115*	-10,4000 V	Sortie dans la plage 0 dB
116	+0,0430 V	Sortie dans la plage CC haute -48 dB
117*	-0,0430V	Sortie dans la plage CC haute -48 dB
118	+0,1060 V	Sortie dans la plage CC haute -40 dB
119*	-0,1060 V	Sortie dans la plage CC haute -40 dB
120	+0,2680 V	Sortie dans la plage CC haute -32 dB
121*	-0,2680 V	Sortie dans la plage CC haute -32 dB
122	+0,6600 V	Sortie dans la plage CC haute -24 dB
123*	-0,6600 V	Sortie dans la plage CC haute -24 dB

\* Les constantes sont enregistrées après cette configuration.

3. À l'aide du clavier numérique ou du bouton, réglez la tension affichée pour chaque réglage sur la tension mesurée. Sélectionnez **ENTER VALUE**.
4. Ensuite :
  - a. Si vos procédures d'étalonnage requièrent la vérification de ce réglage, quittez le menu d'étalonnage et procédez à la **vérification de l'amplitude CA (haute impédance)**.
  - b. Si vous effectuez tous les réglages sur un instrument 2 voies et vérifiez ensuite le fonctionnement de l'instrument, passez à la procédure suivante de cette section.

[Rubrique d'étalonnage précédente](#)   [Rubrique d'étalonnage suivante](#)

#### Réglage de la planéité 1 Vpp (voie 2) - Série 33600

1. Pour les fréquences atteignant 20 MHz, connectez un voltmètre CA de précision pour mesurer l'amplitude de sortie, comme indiqué ci-dessous. Connectez le câble BNC à l'entrée large bande de l'instrument Fluke 5790A.

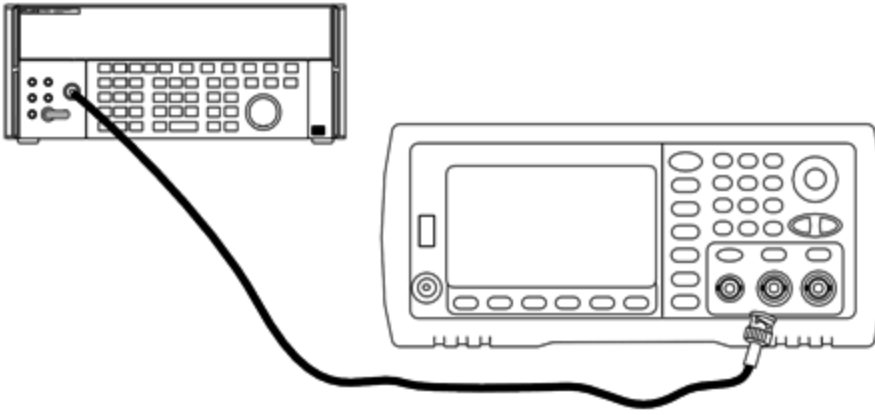

Pour les fréquences supérieures à 20 MHz, connectez un wattmètre et une sonde de puissance de précision pour mesurer l'amplitude de sortie, comme indiqué ci-dessous.

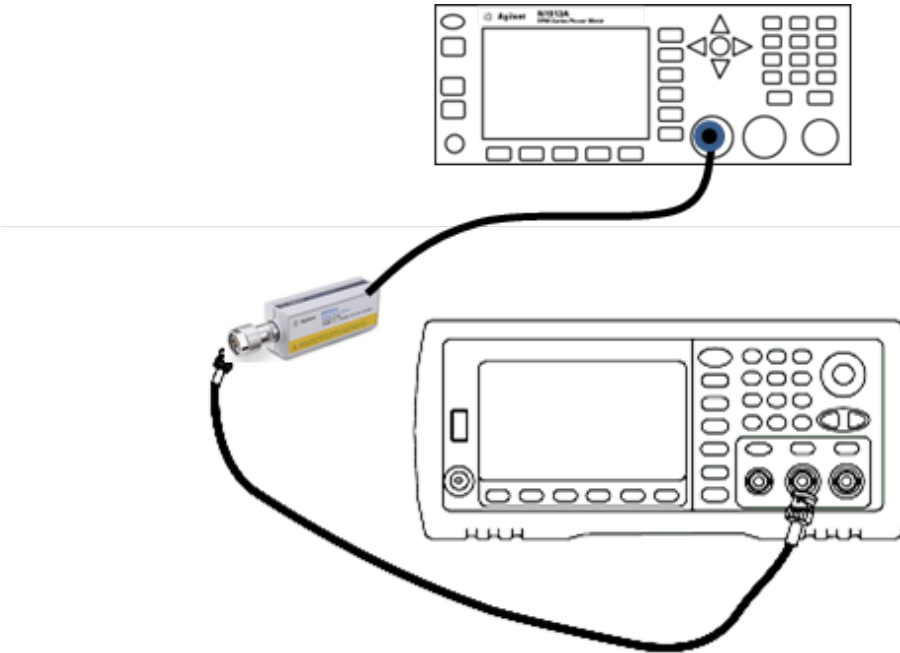

2. Utilisez le voltmètre CA de précision pour mesurer l'amplitude de sortie de chaque réglage figurant dans le tableau ci-dessous.

Réglage	Signal nominal		
	Fréquence	Amplitude	
124*	1 kHz	380 mVeff	Planéité dans la plage 1 Vpp
125*	100 kHz		
126*	1 MHz		
127*	5 MHz		
128*	10 MHz		
129*	20 MHz		
130*	25 MHz		
131*	30 MHz		
132	40 MHz		
133	50 MHz		
134	60 MHz		
135	70 MHz		
136	80 MHz		
137	90 MHz		
138	100 MHz		
139	110 MHz		
140	120 MHz		

\* Les constantes sont enregistrées après cette configuration.

3. À l'aide du clavier numérique ou du bouton, réglez la tension affichée pour chaque réglage sur la tension mesurée. Sélectionnez **ENTER VALUE**.
4. Ensuite :
- Si vos procédures d'étalonnage requièrent la vérification du réglage qui vient d'être effectué, quittez le menu d'étalonnage et procédez à la **Vérification de la planéité dans la plage 1 Vpp**. Assurez-vous d'effectuer cette opération pour la voie 2.
  - Si vous effectuez tous les réglages sur un instrument 2 voies et vérifiez ensuite le fonctionnement de l'instrument, passez à la procédure suivante de cette section.

[Rubrique d'étalonnage précédente](#)   [Rubrique d'étalonnage suivante](#)

### Réglage de la planéité dans la plage 4 Vpp (voie 2) - Série 33600

Cette section concerne la voie 2. Elle vérifie la planéité de l'amplitude CA haute fréquence dans la plage -8 dB de l'atténuateur. Elle vérifie également la planéité sur toutes les autres plages, à l'exclusion des plages -24 dB et 0 dB de l'atténuateur.

1. Pour les fréquences atteignant 20 MHz, connectez un voltmètre CA de précision pour mesurer l'amplitude de sortie, comme indiqué ci-dessous. Connectez le câble BNC à l'entrée large bande de l'instrument Fluke 5790A.

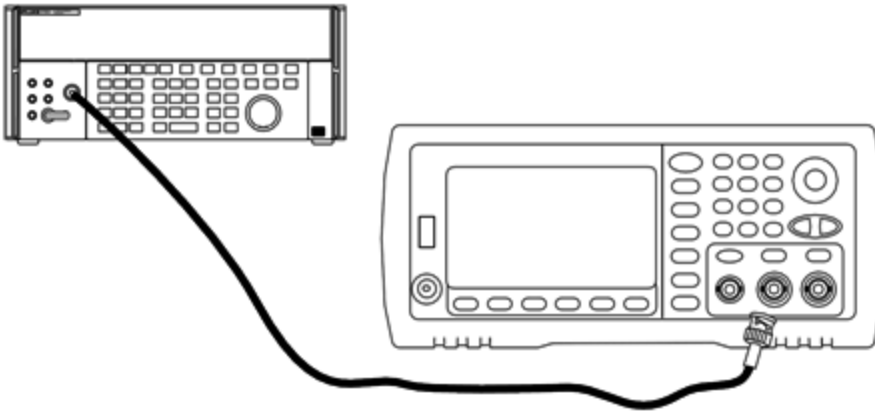

Pour les fréquences supérieures à 20 MHz, connectez un wattmètre et une sonde de puissance de précision pour mesurer l'amplitude de sortie, comme indiqué ci-dessous.

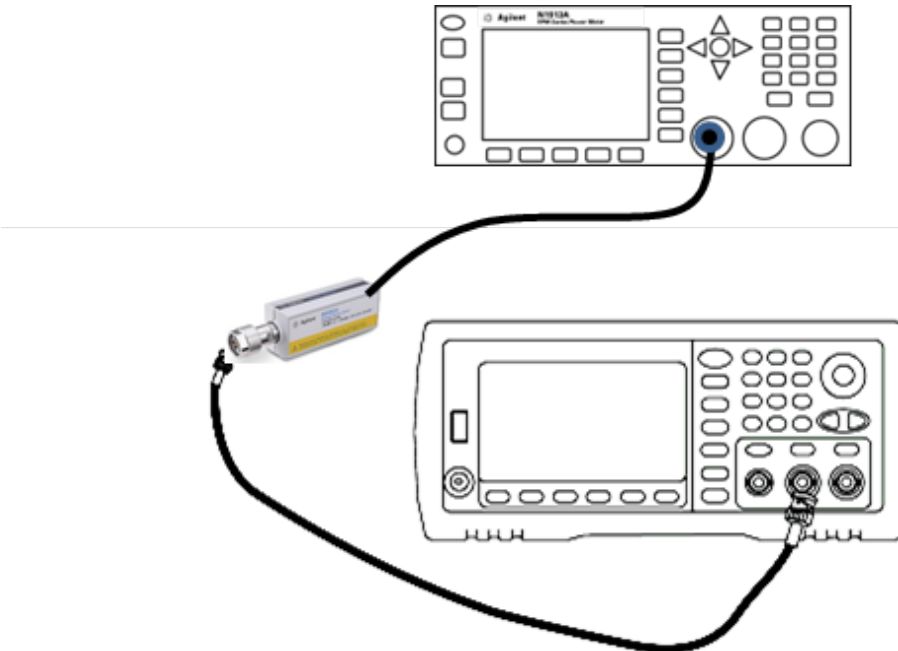

2. Utilisez le voltmètre CA de précision pour mesurer l'amplitude de sortie de chaque réglage figurant dans le tableau ci-dessous.

Réglage	Signal nominal		
	Fréquence	Amplitude	
141*	1 kHz	960 mVeff	Planéité de la plage -8 dB
142*	100 kHz		
143*	1 MHz		
144*	5 MHz		
145*	10 MHz		
146*	20 MHz		
147*	25 MHz		
148*	30 MHz		
149	40 MHz		
150	50 MHz		
151	60 MHz		
152	70 MHz		
153	80 MHz		
154	90 MHz		
155	100 MHz		
156	110 MHz		
157	120 MHz		

\* Les constantes sont enregistrées après cette configuration.

3. À l'aide du clavier numérique ou du bouton, réglez la tension affichée pour chaque réglage sur la tension mesurée. Sélectionnez **ENTER VALUE**.
4. Les procédures de réglage recommandées sont à présent terminées. Une vérification des spécifications de sortie est recommandée.
  - a. Si vos procédures d'étalonnage requièrent la vérification du réglage qui vient d'être effectué, quittez le menu d'étalonnage et procédez à la **Vérification de la planéité dans la page 4 Vpp**.

[Rubrique d'étalonnage précédente](#)   [Rubrique d'étalonnage suivante](#)

### Réglage de la planéité 8 Vpp - Série 33600

1. Pour les fréquences atteignant 20 MHz, connectez un voltmètre CA de précision pour mesurer l'amplitude de sortie, comme indiqué ci-dessous. Connectez le câble BNC à l'entrée large bande de l'instrument Fluke 5790A.

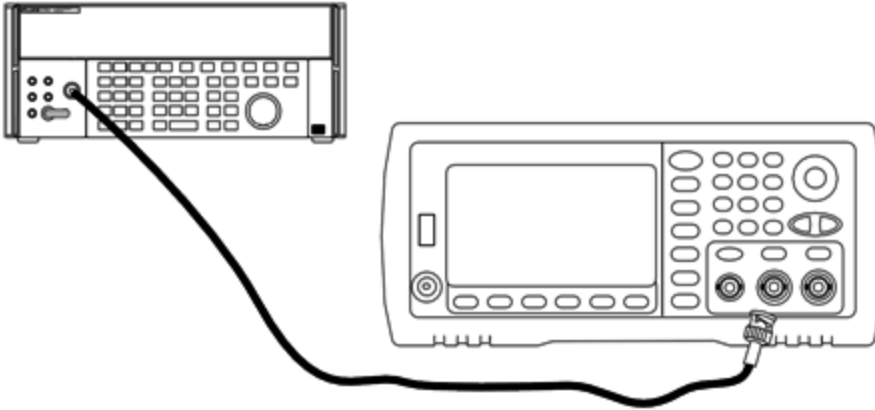

Pour les fréquences supérieures à 20 MHz, connectez un wattmètre et une sonde de puissance de précision pour mesurer l'amplitude de sortie, comme indiqué ci-dessous.

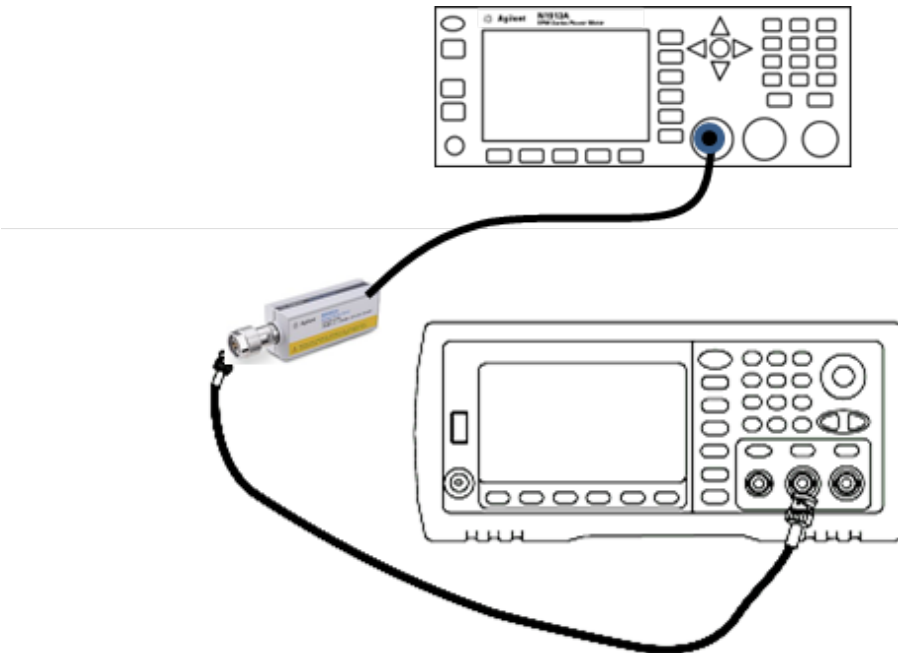

2. Utilisez le voltmètre CA de précision pour mesurer l'amplitude de sortie de chaque réglage figurant dans le tableau ci-dessous.

Réglage	Signal nominal		
	Fréquence	Amplitude	
158*	1 kHz	2,4 Veff	Planéité dans la plage 0 dB
159*	100 kHz		
160*	1 MHz		
161*	5 MHz		
162*	10 MHz		
163*	20 MHz		
164*	25 MHz		
165*	30 MHz		
166	40 MHz		
167	50 MHz		
168	60 MHz		
169	70 MHz		
170	80 MHz		

\* Les constantes sont enregistrées après cette configuration.

3. À l'aide du clavier numérique ou du bouton, réglez la tension affichée pour chaque réglage sur la tension mesurée. Sélectionnez **ENTER VALUE**.
4. Ensuite :
  - a. Si vos procédures d'étalonnage requièrent la vérification du réglage qui vient d'être effectué, quittez le menu d'étalonnage et procédez à la **Vérification de la planéité dans la plage 8 Vpp**.
  - b. Si vous effectuez les réglages et vérifiez ensuite le fonctionnement de l'instrument, vérifiez les spécifications de sortie en effectuant les **tests de vérification des performances**.

Les procédures de réglage d'un instrument 1 voie sont à présent terminées. Une vérification des spécifications de sortie est recommandée.

Si vous effectuez les réglages sur un instrument 2 voies, passez à la procédure suivante de cette section.

[Rubrique d'étalonnage précédente](#)   [Rubrique d'étalonnage suivante](#)

## Erreurs d'étalonnage - Série 33600

Les erreurs suivantes peuvent se produire pendant l'étalonnage. Des **erreurs système** et des **erreurs d'autotest** sont également possibles. Certains messages d'erreur incluent un numéro de voie défectueuse (1 ou 2), indiqué sous la forme n dans les messages ci-dessous.



### **701 Calibration error; security defeated by hardware jumper**

Si vous mettez en court-circuit le cavalier de sécurité de l'étalonnage (CAL ENABLE) lorsque vous allumez l'instrument, cette erreur indique que le mot de passe de sécurité a été remplacé. Pour plus d'informations, reportez-vous à la section [Sécurité de l'étalonnage](#).

### **702 Calibration error; calibration memory is secured**

Pour effectuer l'étalonnage, déverrouillez la sécurité de l'instrument. Pour plus d'informations, reportez-vous à la section [Sécurité de l'étalonnage](#).

### **703 Calibration error; secure code provided was invalid**

Le code de sécurité spécifié n'était pas valide.

### **706 Calibration error; value out of range**

La valeur saisie est hors de la plage valide.

### **707 Calibration error; signal input is out of range**

Se produit pendant le réglage du convertisseur analogique/numérique (réglage 6) si la tension d'entrée 1 V est trop élevée. Peut également se produire pendant l'auto-étalonnage (réglage 7). Exécutez l'autotest pour diagnostiquer le problème.

### **710 Self-calibration failed; Chan n, null DAC cal, invalid self cal**

**Self-calibration failed; Chan n, offset DAC cal with attenuator, invalid self cal**

**Self-calibration failed; Chan n, offset DAC cal no attenuator, invalid self cal**

Erreur lors de l'étalonnage interne du convertisseur numérique/analogique spécifié. Auto-étalonnage terminé sans modification des constantes d'auto-étalonnage. Exécutez l'autotest pour diagnostiquer le problème.

### **711 Self-calibration failed; Chan n, null DAC cal gain too low (too high), <valeur\_mes>**

**Self-calibration failed; Chan n, offset DAC cal with attenuator gain too low (too high), <valeur\_mes>**

**Self-calibration failed; Chan n, offset DAC cal no attenuator gain too low (too high), <valeur\_mes>**

Le facteur d'étalonnage du gain calculé pour le convertisseur numérique/analogique était hors limites. Auto-étalonnage terminé sans modification des constantes d'auto-étalonnage. Exécutez l'autotest pour diagnostiquer le problème.

### **712 Self-calibration failed; Chan n, null DAC cal zero too low (too high), <valeur\_mes>**

**Self-calibration failed; Chan n, offset DAC cal no attenuator zero too low (too high), <valeur\_mes>**

**Self-calibration failed; Chan n, offset DAC cal no attenuator zero too low (too high), <valeur\_mes>**

**Self-calibration failed; Chan n, GND measurement out of limits, <valeur\_mes>**

Le facteur d'étalonnage du zéro calculé pour le convertisseur numérique/analogique était hors limites. Auto-étalonnage terminé sans modification des constantes d'auto-étalonnage. Exécutez l'autotest pour diagnostiquer le problème.

**715 Self-calibration failed; Chan n, null DAC cal, convergence error sub attenuator value dB**

L'étalonnage à vide du convertisseur numérique/analogique interne était incohérent lors de l'étalonnage interne. Auto-étalonnage terminé sans modification des constantes d'auto-étalonnage. Exécutez l'autotest pour diagnostiquer le problème.

**720 Self-calibration failed; Chan n, offset DAC cal with attenuator, convergence error  
Self-calibration failed; Chan n, offset DAC cal no attenuator, convergence error**

L'étalonnage de la tension résiduelle du convertisseur numérique/analogique interne était incohérent lors de l'étalonnage interne. Auto-étalonnage terminé sans modification des constantes d'auto-étalonnage. Exécutez l'autotest pour diagnostiquer le problème.

**850 Calibration error; set up is invalid**

Le numéro du réglage d'étalonnage sélectionné est incorrect.

**850 Calibration error; set up is out of order**

Certaines opérations d'étalonnage requièrent un paramètre de début et de fin. N'entrez pas au milieu d'une séquence d'étalonnage.

[Rubrique d'étalonnage précédente](#)

## Schéma fonctionnel - Série 33500

L'instrument comporte quatre sous-ensembles :

- Processeur
- Carte mère
- Face avant
- Alimentation principale

Un [schéma fonctionnel simplifié](#) apparaît à la fin de cette section.

Le processeur est un ordinateur sur carte qui comprend l'unité centrale, la mémoire vive (RAM), la mémoire morte (ROM) et les circuits de commande des ports GPIB, LAN et USB. L'interface web intégrée réside dans la mémoire morte (ROM). Les circuits du processeur sont reliés à la masse.

Lorsque l'interrupteur d'alimentation est enfoncé, le processeur communique avec le réseau de portes programmables (FPGA). Cette communication utilise trois lignes de données série asynchrones et une ligne d'horloge série. Ces quatre lignes sont isolées.

Le réseau FPGA enregistre tous les signaux à l'exception des signaux arbitraires. Les signaux arbitraires sont chargés dans la mémoire SDRAM de la carte mère. Le réseau FPGA fournit toutes les commandes sur les signaux, les déclencheurs, les signaux de synchronisation, la propagation des sorties, l'atténuation et la tension résiduelle.

Le signal principal de chaque voie (une seule voie est représentée dans le [schéma](#)) est chargé dans le convertisseur numérique/analogique et cadencé par la base de temps. La sortie du convertisseur traverse

un filtre elliptique avant les atténuateurs principaux. Trois atténuateurs sont disponibles dans le chemin de propagation : -7,96 dB, -15,91 dB et -23,87 dB.

Le signal est appliqué à l'amplificateur de sortie. La tension CC résiduelle est ajoutée dans l'amplificateur de sortie. Un atténuateur de -23,87 dB sur un post-amplificateur est disponible pour les signaux faibles. Le tableau ci-dessous présente les atténuateurs qui créent l'amplitude du signal de sortie.

<b>Plage de sortie Tension CC résiduelle &lt; 320 mV</b>	<b>-7,96 dB</b>	<b>-15,91 dB</b>	<b>-23,87 dB</b>	<b>-23,87 dB (post)</b>
10 Vpp - 3,6 Vpp	Sortie	Sortie	Sortie	Sortie
4 Vpp - 1,44 Vpp	Entrée	Sortie	Sortie	Sortie
1,6 Vpp - 576 mVpp	Sortie	Entrée	Sortie	Sortie
640 mVpp - 230 mVpp	Sortie	Sortie	Sortie	Entrée
256 mVpp - 92 mVpp	Entrée	Sortie	Sortie	Entrée
102,4 mVpp - 36,86 mVpp	Sortie	Entrée	Sortie	Entrée
40,96 mVpp - 14,75 mVpp	Sortie	Sortie	Entrée	Entrée
16,38 mVpp - 5,90 mVpp	Entrée	Sortie	Entrée	Entrée
6,55 mVpp - 2,36 mVpp	Sortie	Entrée	Entrée	Entrée
2,62 mVpp - 1,00 mVpp	Entrée	Entrée	Entrée	Entrée

<b>Plage de sortie Tension CC résiduelle ≥ 320 mV</b>	<b>-7,96 dB</b>	<b>-15,91 dB</b>	<b>-23,87 dB</b>	<b>-23,87 dB (post)</b>
9,36 Vpp - 3,6 Vpp	Sortie	Sortie	Sortie	Sortie
4 Vpp - 1,44 Vpp	Entrée	Sortie	Sortie	Sortie
1,6 Vpp - 576 mVpp	Sortie	Entrée	Sortie	Sortie
640 mVpp - 230 mVpp	Sortie	Sortie	Entrée	Sortie
256 mVpp - 92 mVpp	Entrée	Sortie	Entrée	Sortie
102,4 mVpp - 36,86 mVpp	Sortie	Entrée	Entrée	Sortie
40,96 mVpp - 1,00 mVpp	Entrée	Entrée	Entrée	Sortie

Lorsqu'il est activé, le relais de sortie envoie le signal au connecteur BNC de la face avant. De plus, lorsqu'il est désactivé, ce relais envoie le signal au convertisseur analogique/numérique de modulation pour l'autotest interne et les opérations habituelles d'étalonnage.

Le réseau FPGA commande le relais de sortie. Deux circuits assurent la protection contre les surtensions et les surintensités, principalement à partir d'un circuit externe. L'instrument peut envoyer la sortie dans de très faibles impédances.

Le signal de sortie **Sync** est généré sous forme de signal depuis le réseau FPGA sur le convertisseur numérique/analogique **Sync**.

Le déclencheur externe d'entrée et de sortie est relié au châssis sur le connecteur BNC, mais est isolé avant le réseau FPGA.

L'entrée de modulation est une entrée isolée vers le convertisseur A/N. Le réseau FPGA applique le signal de modulation au signal de sortie.

Le générateur d'horloge de l'instrument utilise un oscillateur à quartz 10 MHz et une boucle de verrouillage de phase pour générer les horloges 250 MHz utilisées par le réseau FPGA et les convertisseurs numériques/analogiques des signaux. Lorsqu'une référence de fréquence de 10 MHz est utilisée, une boucle numérique de verrouillage de phase dans le réseau FPGA maintient l'oscillateur synchronisé.

### Schéma fonctionnel - Série 33500

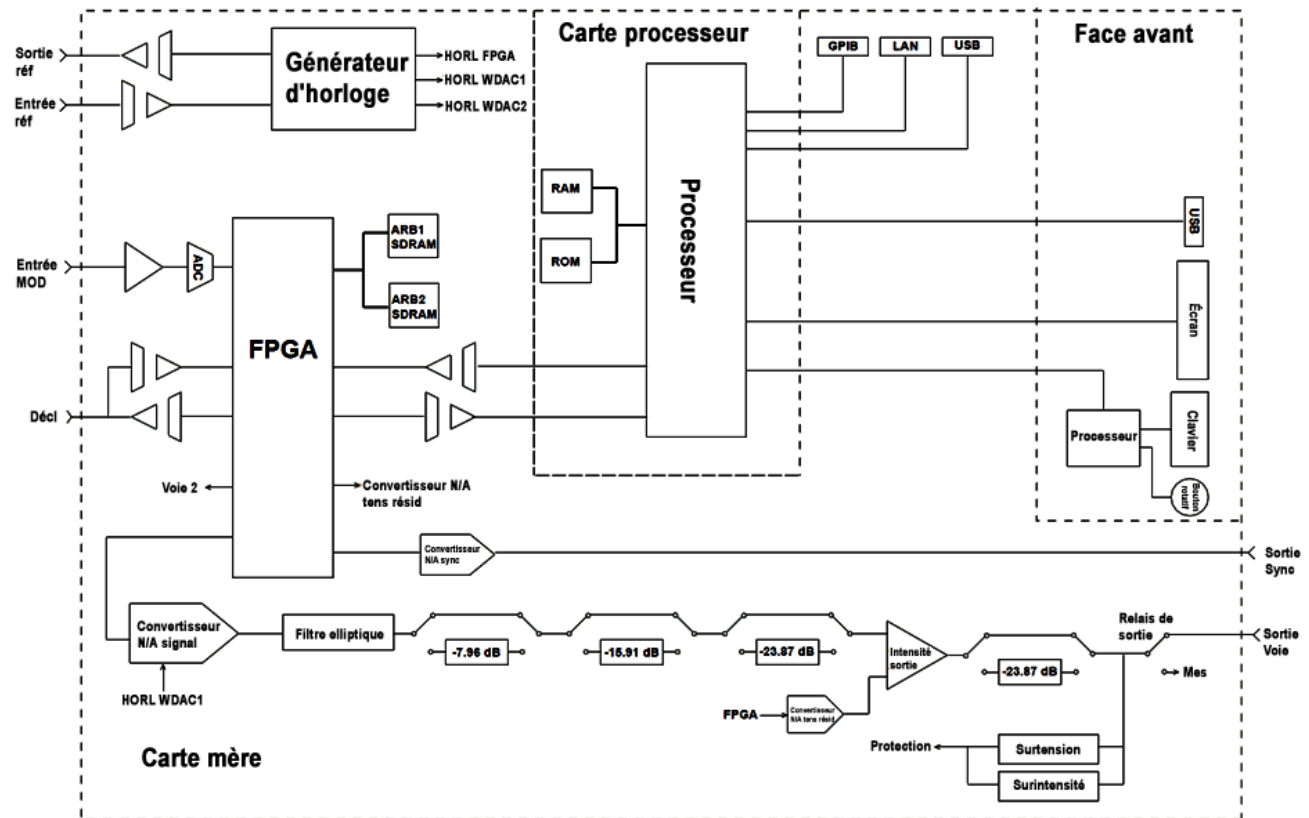

### Schéma fonctionnel - Série 33600

L'instrument comporte quatre sous-ensembles :

- Processeur
- Carte mère

- Face avant
- Alimentation principale

Un **schéma fonctionnel simplifié** apparaît à la fin de cette section.

Le processeur est situé dans l'ensemble de la face avant, et contient l'unité centrale, la mémoire vive (RAM), la mémoire morte (ROM) et les circuits de commande des ports GPIB, LAN et USB. L'interface web intégrée réside dans la mémoire morte (ROM). Les circuits du processeur sont reliés à la masse.

Lorsque l'interrupteur d'alimentation est enfoncé, le processeur communique avec le réseau de portes programmables (FPGA) sur l'ensemble mezzanine. Cette communication utilise trois lignes de données série asynchrones et une ligne d'horloge série. Ces quatre lignes sont isolées.

Le réseau FPGA enregistre tous les signaux à l'exception des signaux arbitraires. Les signaux arbitraires sont chargés dans la mémoire SDRAM de l'ensemble mezzanine. Le réseau FPGA fournit toutes les commandes sur les signaux, les déclencheurs, les signaux de synchronisation, la propagation des sorties, l'atténuation et la tension résiduelle.

Le signal principal de chaque voie (une seule voie est représentée dans le **schéma**) est chargé dans le convertisseur numérique/analogique et cadencé par le générateur d'horloge. La sortie du convertisseur traverse un filtre antirepliement avant les atténuateurs principaux. Trois atténuateurs sont disponibles dans le chemin de propagation : -7,96 dB, -15,91 dB et -23,87 dB.

Le signal est appliqué à l'amplificateur de sortie. La tension CC résiduelle est ajoutée dans l'amplificateur de sortie. Un atténuateur de -23,87 dB sur un post-amplificateur est disponible pour les signaux faibles. Le tableau ci-dessous présente les atténuateurs qui créent l'amplitude du signal de sortie.

<b>Plage de sortie Tension CC résiduelle &lt; 320 mV</b>	<b>-7,96 dB</b>	<b>-15,91 dB</b>	<b>-23,87 dB</b>	<b>-23,87 dB (post)</b>
10 Vpp - 4,0001 Vpp	Sortie	Sortie	Sortie	Sortie
4,1 Vpp - 1,44 Vpp	Entrée	Sortie	Sortie	Sortie
1,6 Vpp - 576 mVpp	Sortie	Entrée	Sortie	Sortie
640 mVpp - 230 mVpp	Sortie	Sortie	Sortie	Entrée
256 mVpp - 92 mVpp	Entrée	Sortie	Sortie	Entrée
102,4 mVpp - 36,86 mVpp	Sortie	Entrée	Sortie	Entrée
40,96 mVpp - 14,75 mVpp	Sortie	Sortie	Entrée	Entrée
16,38 mVpp - 5,90 mVpp	Entrée	Sortie	Entrée	Entrée
6,55 mVpp - 2,36 mVpp	Sortie	Entrée	Entrée	Entrée
2,62 mVpp - 1,00 mVpp	Entrée	Entrée	Entrée	Entrée

<b>Plage de sortie Tension CC résiduelle <math>\geq</math> 320 mV</b>	<b>-7,96 dB</b>	<b>-15,91 dB</b>	<b>-23,87 dB</b>	<b>-23,87 dB (post)</b>
9,36 Vpp - 3,6 Vpp	Sortie	Sortie	Sortie	Sortie
4 Vpp - 1,44 Vpp	Entrée	Sortie	Sortie	Sortie
1,6 Vpp - 576 mVpp	Sortie	Entrée	Sortie	Sortie
640 mVpp - 230 mVpp	Sortie	Sortie	Entrée	Sortie
256 mVpp - 92 mVpp	Entrée	Sortie	Entrée	Sortie
102,4 mVpp - 36,86 mVpp	Sortie	Entrée	Entrée	Sortie
40,96 mVpp - 1,00 mVpp	Entrée	Entrée	Entrée	Sortie
Fonction DC Volts < 320 mV	Entrée	Entrée	Entrée	Entrée
Fonction DC Volts $\geq$ 320 mV	Entrée	Entrée	Entrée	Sortie

Deux relais du bloc Commutation et filtres de sortie fournissent trois chemins au connecteur BNC de la face avant (un filtre à passage direct et deux filtres à passage qui réduisent la distorsion de la sortie), ainsi qu'un chemin ouvert pour désactiver la sortie. Une version atténuée de la sortie est transmise au convertisseur analogique/numérique de modulation en vue d'être utilisée pour l'autotest et l'étalonnage internes.

Les relais de sortie sont contrôlés par le réseau FPGA. Deux circuits assurent la protection contre les surtensions et les surintensités, principalement à partir d'un circuit externe. L'instrument peut envoyer la sortie dans de très faibles impédances.

Le signal de sortie **Sync** est généré sous forme de signal depuis le réseau FPGA sur le convertisseur numérique/analogique **Sync**.

Le déclencheur externe d'entrée et de sortie est relié au châssis sur le connecteur BNC, mais est isolé avant le réseau FPGA.

L'entrée de modulation est une entrée vers le convertisseur A/N. Le réseau FPGA applique le signal de modulation au signal de sortie.

Le générateur d'horloge de l'instrument utilise un oscillateur à quartz 10 MHz et une boucle de verrouillage de phase pour générer les horloges 2 GHz utilisées par le réseau FPGA et les convertisseurs numériques/analogiques des signaux. Lorsqu'une référence de fréquence de 10 MHz est utilisée, une boucle à verrouillage de phase dans le réseau FPGA maintient l'oscillateur synchronisé.

Schéma fonctionnel - Série 33600

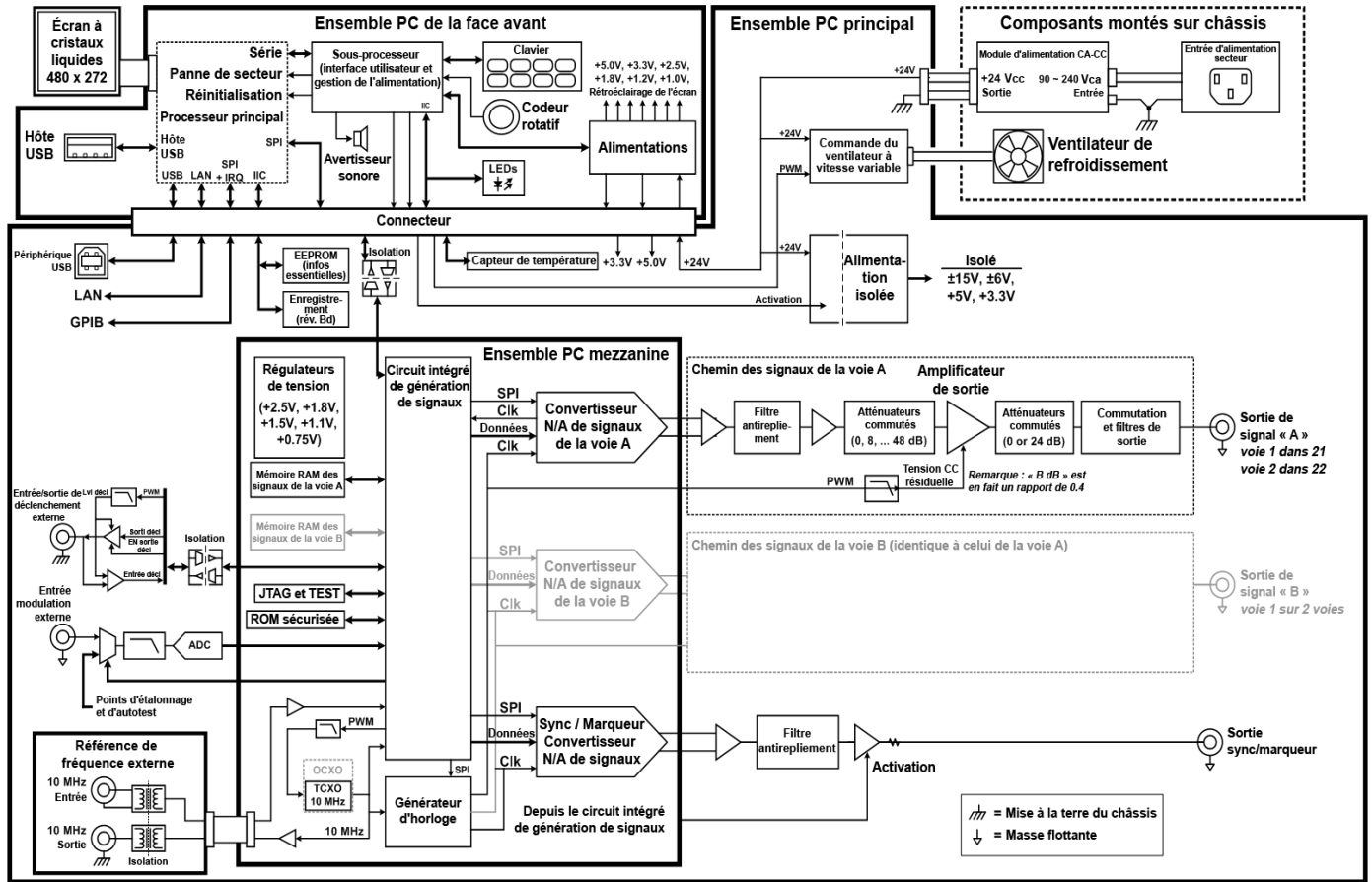

Alimentations - Série 33500

La tension secteur est filtrée et appliquée à l'alimentation principale de +15 V qui fonctionne toujours lorsque la tension secteur est utilisée. Un régulateur crée une tension de +3,3 V par rapport à la masse ; il fonctionne également en permanence lorsque la tension secteur est appliquée.

Un petit microprocesseur sur la carte mère détecte la position de l'interrupteur d'alimentation et active les autres alimentations.

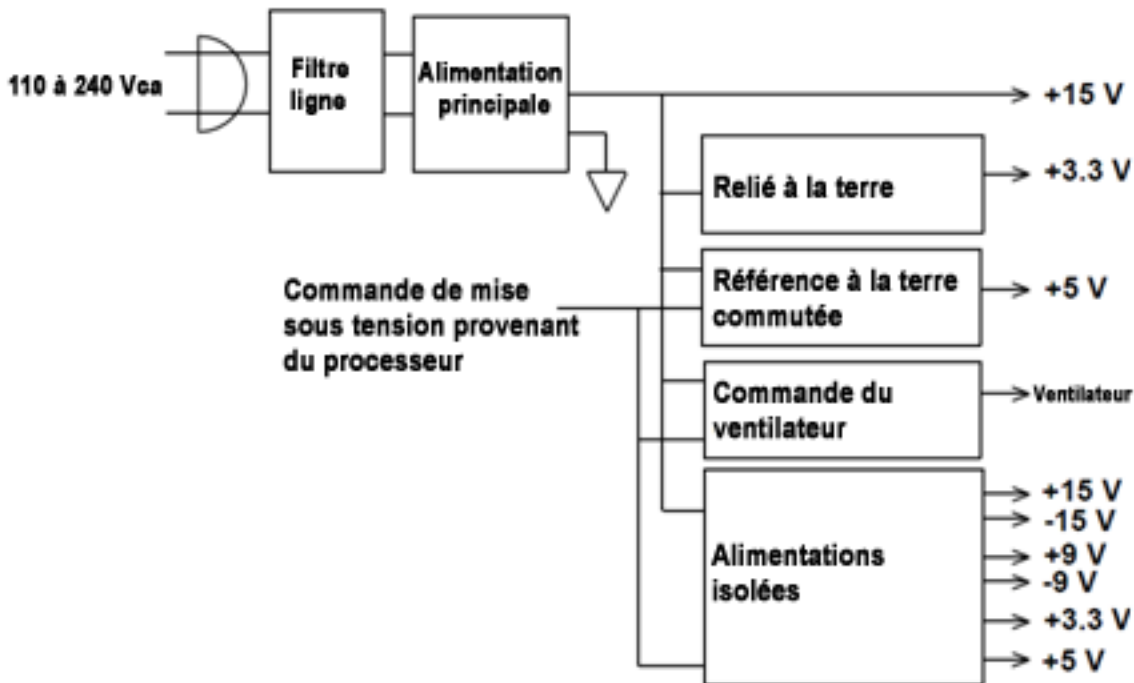

## Alimentations - Série 33600

La tension secteur est filtrée et appliquée à l'alimentation principale de +24 V qui fonctionne toujours lorsque la tension secteur est utilisée. Un régulateur crée une tension de +5 V par rapport à la masse ; il fonctionne également en permanence lorsque la tension secteur est appliquée.

Un petit microprocesseur sur la face avant détecte la position de l'interrupteur d'alimentation et active les autres alimentations.

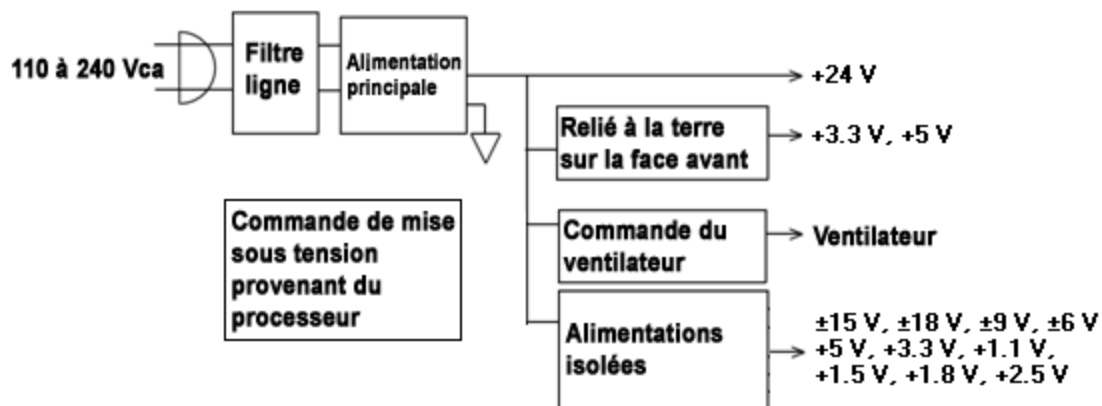

## Dépannage - Série 33500

Vous trouverez ci-dessous une brève liste des principaux problèmes. Avant de dépanner ou de réparer l'instrument, vérifiez que la panne provient de l'instrument et non de connexions externes. Assurez-vous



également que l'instrument a été étalonné avec précision au cours de l'année précédente. Les circuits de l'instrument permettent le dépannage et les réparations avec un équipement de test courant.

### L'appareil ne fonctionne pas

Vérifiez que :

- le cordon d'alimentation CA est solidement fixé à l'instrument et branché dans une prise secteur sous tension
- l'interrupteur d'alimentation Power On/Standby la face avant est enfoncé

### L'appareil échoue à l'autotest

Assurez-vous que toutes les connexions (avant et arrière) sont débranchées pendant l'autotest. Pendant l'autotest, des erreurs peuvent se produire à cause de signaux présents sur les câbles externes (par ex., longs câbles de test qui provoquent un effet d'antenne).

#### ATTENTION

NE REMPLACEZ PAS la carte mère, la carte processeur ou la face avant par ces composants d'un autre instrument. Ces cartes contiennent le numéro du modèle et le numéro de série qui identifient sans équivoque un appareil donné ; des cartes ne correspondant pas à l'instrument peuvent poser des problèmes de fonctionnement, de licence, de maintenance, d'importation/exportation ou de garantie.

## Alimentations

Vérifiez l'alimentation principale.

#### AVERTISSEMENT

Risque d'électrocution. Pour contrôler les alimentations, déposez le capot de l'instrument, comme décrit dans la section **Démontage**).

L'alimentation principale fournit une tension de +15 Vcc ( $\pm 0,3$  Vcc) à la carte mère. Toutes les alimentations proviennent de cette alimentation. Cette alimentation est sous tension en permanence lorsque le cordon d'alimentation est branché.

Testez l'alimentation sur le connecteur de la carte mère. Notez que l'alimentation n'est pas reliée au châssis lorsqu'elle est déconnectée de la carte mère.

- Une panne dans les circuits peut provoquer des charges importantes qui peuvent faire chuter la tension de sortie. Déconnectez l'alimentation principale de la carte mère à tester.
- Vérifiez toujours que l'alimentation ne comporte pas d'oscillations au moyen d'un oscilloscope.
- L'alimentation principale contient un fusible. Il est déconseillé de remplacer ce dernier. Remplacez l'alimentation principale complète. Notez que les pannes d'alimentation sont souvent dues à des défaillances d'autres instruments.

#### ATTENTION

Les dissipateurs de chaleur de la carte mère fonctionnent à des potentiels différents. Des détériorations peuvent se produire si des dissipateurs sont court-circuités ensemble. Redoublez d'attention lors du test de la carte mère.

Vérifiez les alimentations indiquées dans le tableau ci-dessous et représentées dans le **schéma fonctionnel des alimentations**. Il est possible de tester les alimentations reliées à la masse en utilisant le châssis comme masse. Il est possible de tester les alimentations à l'aide d'un des dissipateurs de chaleur illustrés dans la figure.

Alimentation			
+3,3 V ER*	+15 V isolé	+9 V isolé	+3,3 V isolé
+5 ER	-15 V isolé	-9 V isolé	+5 V isolé

\* Cette alimentation est active lorsque la tension secteur CA est appliquée à l'instrument.

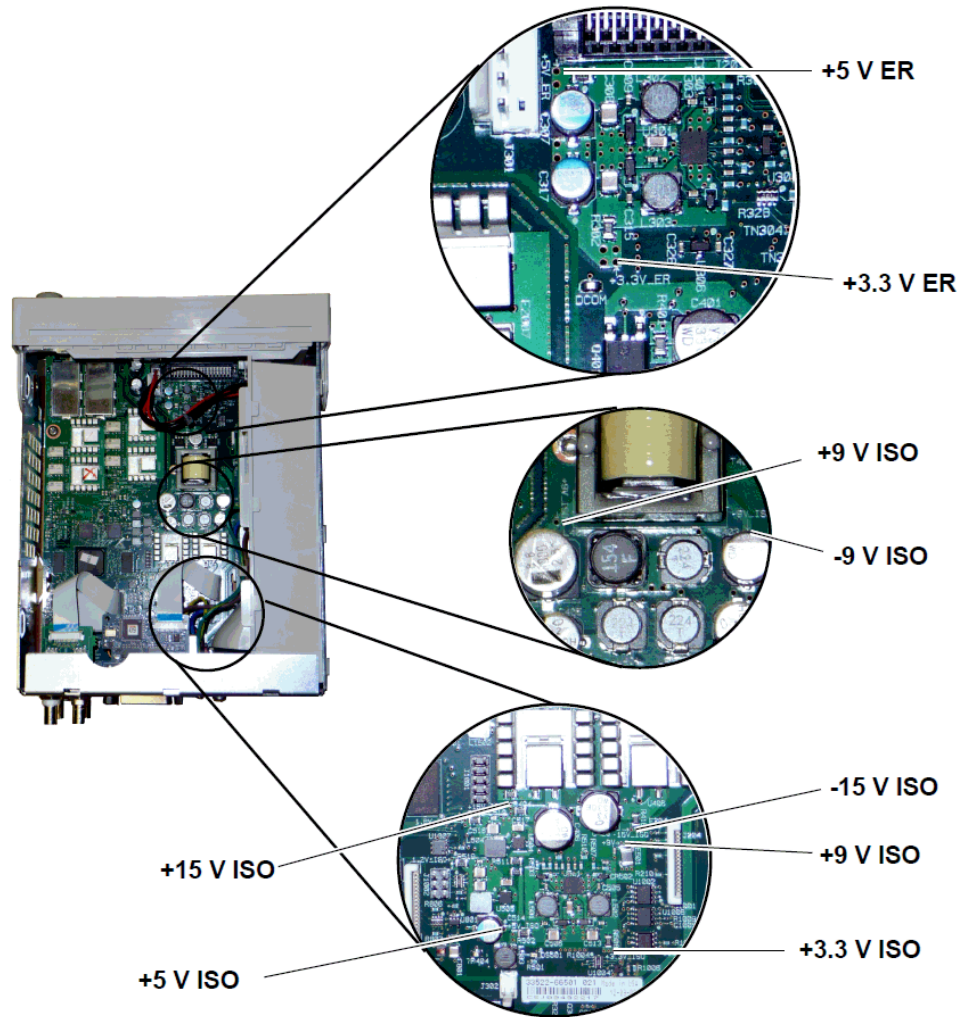

### Erreurs d'autotest 605 à 609

Les erreurs d'autotest 605 à 609 indiquent que la carte processeur ne peut pas programmer ou communiquer correctement avec le réseau FPGA des signaux (U1005) sur la carte mère. Dans ce cas, un dépannage plus approfondi est nécessaire. Le problème peut provenir d'un microprogramme obsolète, ou d'une carte mère ou de processeur défectueuse ou incorrectement insérée. Avant de résoudre ces erreurs, assurez-vous que le microprogramme de l'instrument est à jour. Si ces erreurs persistent, passez à la procédure suivante.

### Réinsertion des cartes

Mettez l'appareil hors tension, déposez le capot. Réinsérez la carte processeur et la carte mère. Mettez l'appareil sous tension et vérifiez si les erreurs 605 à 609 sont toujours signalées à la mise sous tension.

### Vérification des alimentations

Testez les alimentations du système et vérifiez qu'elles fonctionnent dans les limites de l'appareil. Si une alimentation est hors limite, effectuez un diagnostic de l'alimentation. Sinon, passez à la procédure de vérification des communications SPI.

### Vérification des communications SPI

Si vous constatez encore des erreurs après avoir réinséré les cartes, testez les lignes de communication SPI entre la carte processeur et la carte mère. En premier lieu, localisez la DEL DS1001 sur la carte mère, comme indiqué ci-dessous. Remettez l'appareil sous tension, attendez qu'il ait totalement démarré et vérifiez si la DEL de la carte mère est allumée. Cette DEL indique si le réseau FPGA a été correctement programmé. Les sections suivantes indiquent les lignes des signaux à tester sur le connecteur de la carte mère (J201).

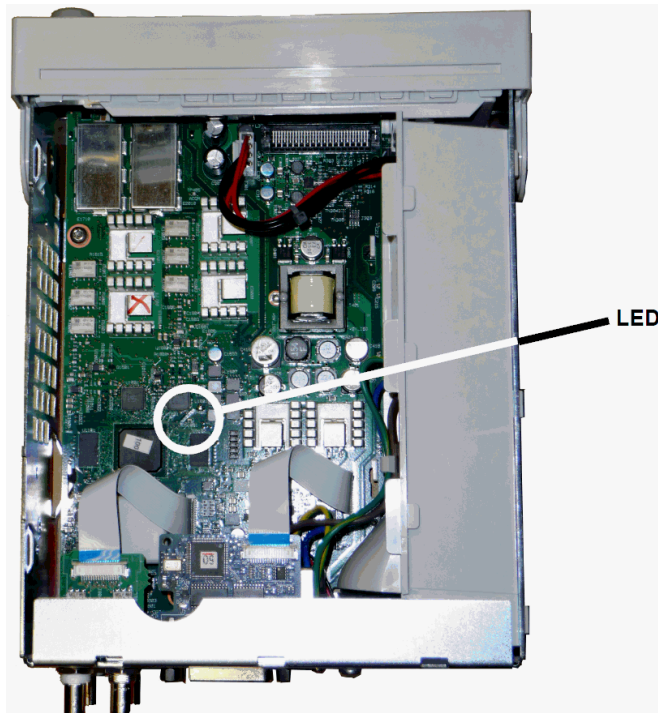

### La DEL de la Carte mère est allumée après le démarrage

Cela indique que le réseau FPGA est programmé et qu'il fonctionne correctement. Il y a très probablement un problème de communication entre la carte mère et la carte processeur. Testez la broche 27 de la ligne J201 et remettez l'appareil sous tension (patientez jusqu'au démarrage complet) pour déterminer l'existence d'une activité sur cette ligne. Des impulsions de +3,3 V (isolées) doivent se produire. Notez que cette activité cesse lorsque l'instrument démarre.

- En l'absence d'activité sur cette ligne, même après que la DEL soit allumée, il est probable que le problème soit dû à une défaillance de la carte mère.
- Si vous constatez l'existence d'une activité, il est probable que le problème soit dû à une défaillance de la carte processeur.

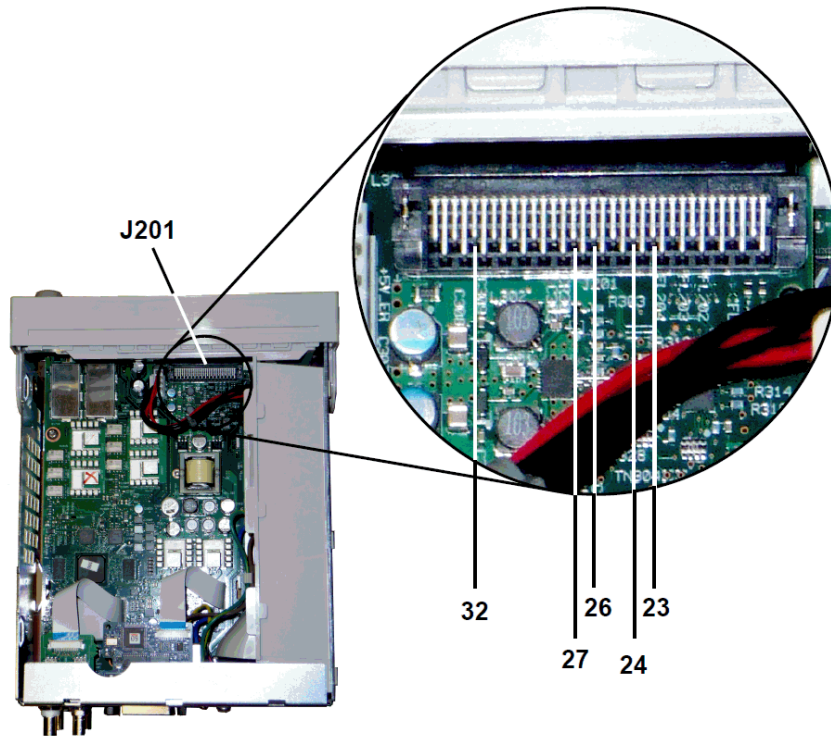

### La DEL de la Carte mère ne s'allume pas après le démarrage

Cela indique que le processeur ne peut pas programmer le réseau FPGA. Il y a très probablement un problème de communication entre la carte processeur et la carte mère. Testez les lignes de signaux série suivantes à la mise sous tension avec un oscilloscope :

- J201, broche 23
- J201, broche 24
- J201, broche 26
- J201, broche 32

Si toutes les lignes SPI présentent une activité pendant la programmation du réseau FPGA, la carte mère est probablement défectueuse. Sinon, la carte processeur est probablement défectueuse.

### Sortie 10 MHz

Si les alimentations fonctionnent et que l'autotest aboutit, vérifiez la sortie 10 MHz sur la face arrière. Cette sortie est présente lorsque l'instrument est sous tension, et que la carte processeur et la carte mère fonctionnent correctement. Si la sortie 10 MHz est présente, mais que l'écran ne fonctionne pas, examinez le montage de la face avant ou de l'écran.

## Dépannage - Série 33600

Vous trouverez ci-dessous une brève liste des principaux problèmes. Avant de dépanner ou de réparer l'instrument, vérifiez que la panne provient de l'instrument et non de connexions externes. Assurez-vous également que l'instrument a été étalonné avec précision au cours de l'année précédente. Les circuits de l'instrument permettent le dépannage et les réparations avec un équipement de test courant.

### L'appareil ne fonctionne pas

Vérifiez que :

- le cordon d'alimentation CA est solidement fixé à l'instrument et branché dans une prise secteur sous tension
- l'interrupteur d'alimentation Power On/Standby la face avant est enfoncé

### L'appareil échoue à l'autotest

Assurez-vous que toutes les connexions (avant et arrière) sont débranchées pendant l'autotest. Pendant l'autotest, des erreurs peuvent se produire à cause de signaux présents sur les câbles externes (par ex., longs câbles de test qui provoquent un effet d'antenne).

#### ATTENTION

NE REMPLACEZ PAS la carte mère, la carte processeur ou la face avant par ces composants d'un autre instrument. Ces cartes contiennent le numéro du modèle et le numéro de série qui identifient sans équivoque un appareil donné ; des cartes ne correspondant pas à l'instrument peuvent poser des problèmes de fonctionnement, de licence, de maintenance, d'importation/exportation ou de garantie.

## Alimentations

Vérifiez l'alimentation principale.

#### AVERTISSEMENT

Risque d'électrocution. Pour contrôler les alimentations, déposez le capot de l'instrument, comme décrit dans la section **Démontage**.

L'ensemble d'alimentation principale fournit une tension de +24 Vcc à la carte mère. Toutes les autres alimentations proviennent de cette alimentation. Cette alimentation est sous tension en permanence lorsque le cordon d'alimentation est branché.

#### ATTENTION

Testez l'alimentation sur le connecteur de la carte mère. Notez que l'alimentation n'est pas reliée au châssis lorsqu'elle est déconnectée de la carte mère. Si le connecteur est branché à la carte mère, assurez-vous que la vis de montage de cette dernière est en place et que la masse d'entrée CA (fil vert/jaune) est reliée au châssis.

- Une panne dans les circuits peut provoquer des charges importantes susceptible de faire chuter la tension de sortie. Débranchez l'alimentation principale de la carte mère à tester.
- Vérifiez toujours que l'alimentation ne comporte pas d'oscillations au moyen d'un oscilloscope.

#### ATTENTION

L'alimentation principale comprend deux fusibles. Il est déconseillé de remplacer ces derniers. Remplacez l'alimentation principale complète. Notez que les pannes d'alimentation sont souvent dues à des défaillances d'autres instruments.

**ATTENTION**

Les dissipateurs de chaleur de la carte mère fonctionnent à des potentiels différents. Des détériorations peuvent se produire si des dissipateurs sont court-circuités ensemble. Redoublez d'attention lors du test de la carte mère.

### Alimentations de la carte mère

Vérifiez les alimentations indiquées dans le tableau ci-dessous et représentées dans le **schéma fonctionnel des alimentations**. Il est possible de tester les alimentations reliées à la masse en utilisant le châssis comme masse. Il est possible de tester les alimentations à l'aide d'un des dissipateurs de chaleur.

La tension secteur est filtrée et appliquée à l'alimentation principale de +24 V ( $\pm 0,3$  Vcc) qui fonctionne toujours lorsque la tension secteur est appliquée. Les régulateurs situés sur la carte de la face avant créent des tensions de +5 V et de +3,3 V par rapport à la masse ; ils fonctionnent également en permanence lorsque la tension secteur est appliquée.

Les DEL de la carte mère s'allument à la mise sous tension pour indiquer que les alimentations isolées de +5 V et +3,3 V fonctionnent correctement. Sur la carte mère, la DEL DS2001 s'allume pour indiquer que l'alimentation isolée de +3,3 V fonctionne correctement et la DEL DS2002 s'allume pour indiquer que l'alimentation isolée de +5 V est opérationnelle.

Alimentations de la carte mère			
+3,3 V ER*	+15 V isolé	+9 V isolé	+3,3 V isolé*** DS2001
+5 ER	-15 V isolé	-9 V isolé	+5 V isolé**, *** DS2002

\* Cette alimentation est active lorsque la tension secteur CA est appliquée à l'instrument.

\*\* Cette alimentation fournit également la puissance aux alimentations de la carte mezzanine.

\*\*\* Cette alimentation est dotée d'une LED d'indication d'état de l'alimentation, illustrée ci-dessous.

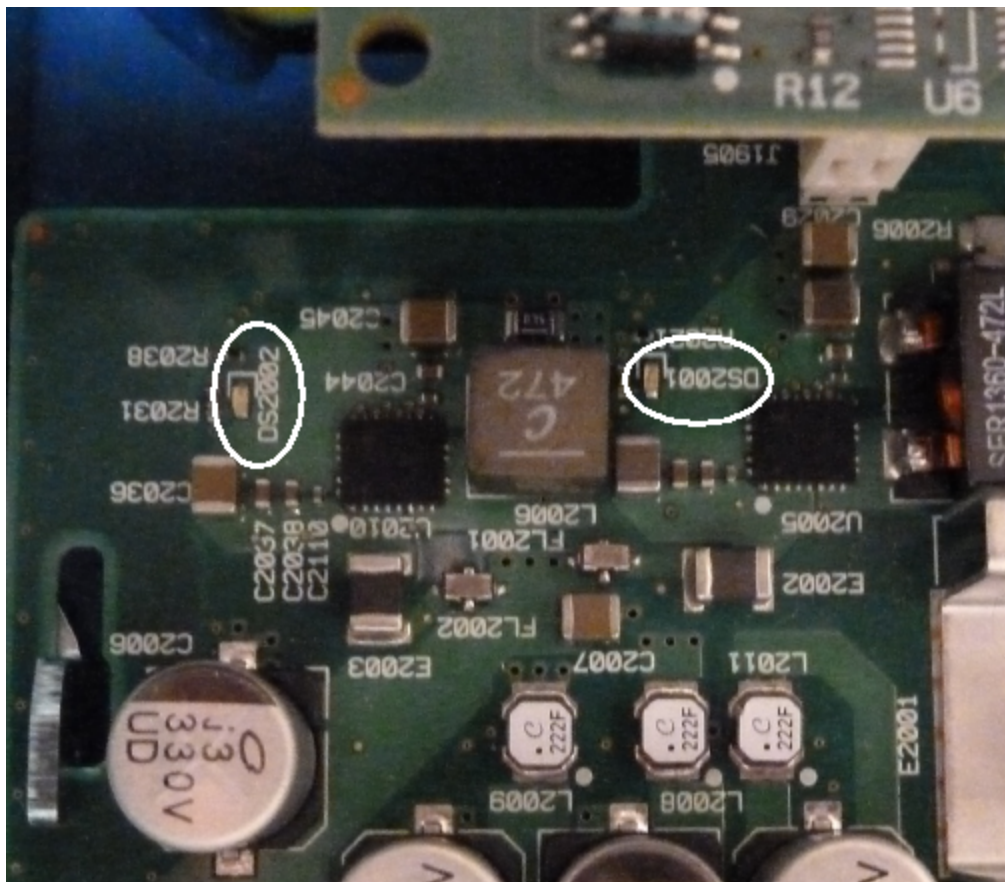

## Alimentations de la carte mezzanine

Alimentations de la carte mezzanine			
+1,1 V*** DS1501	+1,5 V*** DS1501	+1,8 V*** DS1501	+2,5 V*** DS1501

\*\*\* Cette alimentation est dotée d'une LED d'indication d'état de l'alimentation, illustrée ci-dessous.



## Erreurs d'autotest 607 à 611

Les erreurs d'autotest 607 à 611 indiquent que la carte processeur ne peut pas programmer ou communiquer correctement avec le réseau FPGA des signaux (U301) sur la carte mezzanine. Dans ce cas, un dépannage plus approfondi est nécessaire. Le problème peut provenir d'un microprogramme obsolète, ou d'une carte mère ou de processeur défectueuse ou incorrectement insérée. Avant de résoudre ces erreurs, assurez-vous que le microprogramme de l'instrument est à jour. Si ces erreurs persistent, passez à la procédure suivante.

### Réinsertion des cartes

Mettez l'appareil hors tension et déposez le capot. Réinsérez la carte mezzanine et la carte mère. Mettez l'appareil sous tension et vérifiez si les erreurs 607 à 611 sont toujours signalées. Vérifiez toutes les LED d'indication d'état de l'alimentation pour savoir si les alimentations fonctionnent. Certaines alimentations n'incluent pas de LED.

### Vérification des communications SPI

Si vous constatez encore des erreurs d'autotest après avoir réinséré les cartes, testez les lignes de communication SPI entre la carte processeur et la carte mère. En premier lieu, localisez la DEL DS1501 sur la carte mezzanine, comme indiqué ci-dessus. Remettez l'appareil sous tension, attendez qu'il ait totalement démarré et vérifiez si la DEL d'indication d'état de l'alimentation (DS2001, DS2002) de la carte mère est allumée. Vérifiez si la DEL d'indication d'état de l'alimentation de la carte mezzanine DS1501 s'allume. Cette dernière indique que les alimentations de la carte fonctionnent correctement.



### Vérification de la réussite de programmation du réseau FPGA

La DEL DS401 de la carte mezzanine (située à gauche de la DEL DS1501 dans l'image ci-dessus) indique si le réseau FPGA a été correctement programmé. Si elle s'allume, le réseau FPGA est programmé et fonctionne correctement. Si elle ne s'allume pas alors que toutes les alimentations fonctionnent correctement, il y a très probablement un problème de communication entre la carte processeur et la carte mère ou entre la carte mère et la carte mezzanine.

### Vérification des communications SPI

Testez la connexion de la face avant avec les broches 23, 24, 26 et 27 du connecteur J201 de la carte mère pour vérifier l'activité au démarrage entre la carte mère et la carte de la face avant. Des impulsions de +3,3 V (isolées) doivent se produire. Notez que cette activité cesse ou est instable lorsque l'instrument démarre. En l'absence d'activité, l'erreur est probablement due à un dysfonctionnement de la carte de la face avant.

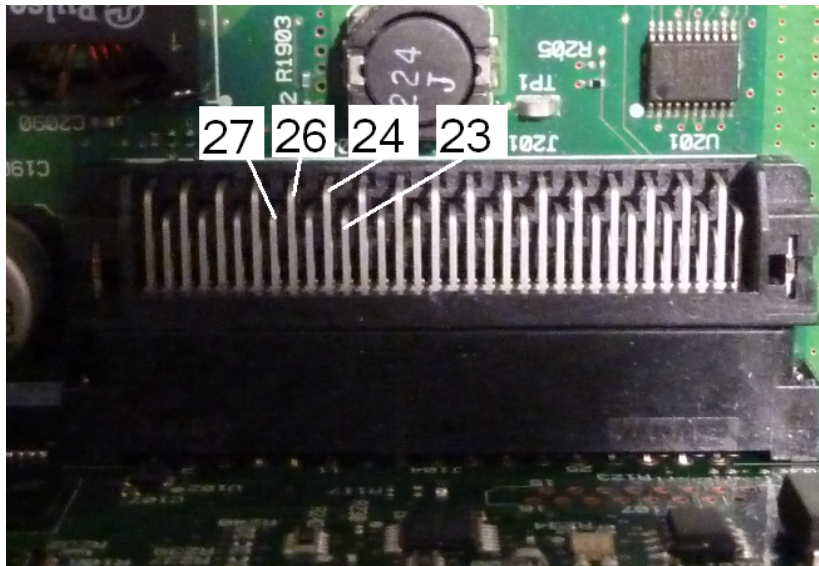

Testez la broche 6 du photocoupleur U602 sur la carte mère à l'aide d'un oscilloscope et remettez l'appareil sous tension (patientez jusqu'au démarrage complet) pour vérifier l'activité sur cette ligne. Cette ligne est utilisée pour réinitialiser le réseau FPGA en vue d'une programmation. Des impulsions de +3,3 V (isolées) doivent se produire.

Vérifiez également l'activité des broches 11, 12, 13 et 14 U601 (sur la carte mère) au démarrage. Notez que cette activité cesse ou est instable lorsque l'instrument démarre.

En l'absence d'activité, l'erreur provient probablement de la carte mère.

Si les broches sont actives mais que la DEL DS401 ne s'allume toujours pas, l'erreur est probablement due à un dysfonctionnement de la carte mezzanine.

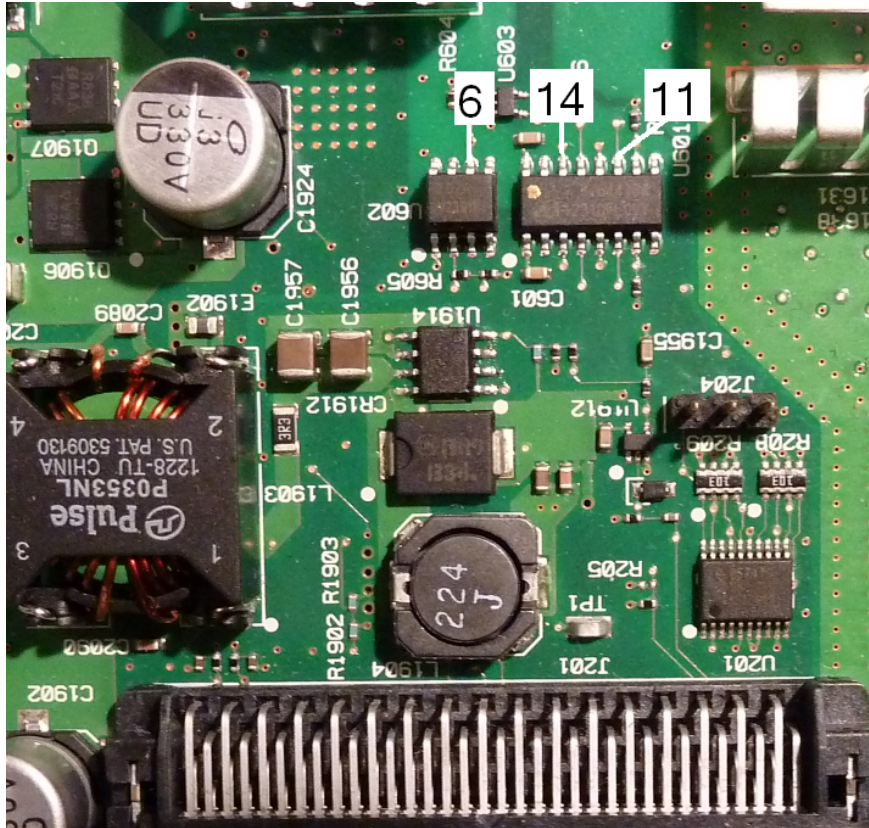

### Sortie 10 MHz

Si les alimentations fonctionnent et que l'autotest aboutit, vérifiez la sortie 10 MHz sur la face arrière. Cette sortie est présente lorsque l'instrument est sous tension, et que la carte processeur et la carte mère fonctionnent correctement. Si la sortie 10 MHz est présente, mais que l'écran ne fonctionne pas, examinez le montage de la face avant ou de l'écran.

## Procédures d'autotest

### Autotest à la mise sous tension

Chaque fois que l'instrument est mis sous tension, des autotests sont effectués pour vérifier que l'ensemble minimal de circuits logiques et de sous-systèmes fonctionnent correctement.

### Autotest complet

La réussite de l'autotest offre un niveau de confiance élevé dans le fonctionnement correct de l'appareil. La procédure d'autotest active automatiquement l'oscillateur interne, les circuits numériques, la mémoire des signaux et les chemins de propagation de l'atténuateur. Il essaie d'isoler les pannes dans un composant donné afin de faciliter la maintenance. Pendant le test, la(les) sortie(s) principale(s) de l'instrument sont déconnectées en interne des connecteurs BNC et connectées au convertisseur analogique/numérique interne ; les niveaux des signaux des signaux dans l'instrument sont contrôlés.

Un autotest complet (**\*TST?**) dure environ 15 secondes. Vous entendrez peut-être des commutations de relais pendant le test. Lorsque l'autotest est terminé, le message « Autotest réussi » ou « Échec de l'autotest » s'affiche sur la face avant. Les messages d'erreur de l'autotest sont décrits en détails ci-dessous.

Exécutez l'autotest avant toute vérification ou réglage.

### Pour exécuter l'autotest

Supprimez toutes les connexions de l'instrument avant l'autotest. Remettez l'instrument sous tension pour exécuter l'autotest à la mise sous tension.

#### À partir de l'interface distante

1. Connectez l'instrument à l'aide de l'interface distante (**Configuration du réseau local**).
2. Exécutez la commande **\*TST?** et lisez le résultat : Réussite (+0) ou échec (+1). Utilisez la commande **SYSTem:ERRor?** pour afficher les résultats.

#### À partir de la face avant

1. Appuyez sur **[System] > Instr Setup > Self Test**.
2. Une barre de progression s'affiche pendant l'exécution de l'autotest. À la fin, affichez les problèmes rencontrés en appuyant sur **[System] > Help**, puis sélectionnez ensuite la rubrique **Affichage de la file d'attente des erreurs de l'interface de commande à distance**.

### Numéros et messages d'erreur des autotests (série 33500)

Une panne peut générer plusieurs messages d'erreur ; le premier doit être considéré comme la cause première de la panne. Certains messages d'erreur incluent un numéro de voie défectueuse (1 ou 2), indiqué

sous la forme n dans les messages ci-dessous.

Erreur	Message et signification (série 33500)	Cause probable (série 33500)
601	<p><b>Self-test failed; real time clock settings lost</b></p> <p>Les paramètres de date/heure de l'horloge temps réel sont perdus, probablement parce que la batterie de l'horloge temps réel (RTC) est déconnectée ou déchargée (pile bouton sur la carte de la face avant). Cette erreur peut également se produire si la carte processeur est retirée et réinsérée dans la face avant. Cette erreur est détectée à la mise sous tension et signalée par l'autotest tant que le problème n'est pas résolu et que l'instrument n'est pas remis sous tension.</p>	Batterie RTC
602	<p><b>Self-test failed; main CPU power supply out of range</b></p> <p>Le processeur a détecté que la tension d'une de ses alimentations était supérieure de 10 % à la tension nominale.</p>	Carte processeur
603	<p><b>Self-test failed; main CPU error accessing boot env</b></p> <p>Le processeur n'a pas accédé à ses paramètres de démarrage (boot) à partir de la mémoire flash, probablement en raison d'un microprogramme obsolète ou d'un problème sur la carte processeur.</p>	Carte processeur
604	<p><b>Self-test failed; front panel processor ping failed</b></p> <p>La carte processeur a tenté de lire le code de la version de la face avant et a reçu un zéro (0), probablement en raison d'un processeur de la face avant non programmé ou d'un processeur de la face avant défectueux.</p>	Carte de la face avant

Erreur	Message et signification (série 33500)	Cause probable (série 33500)
605	<p><b>Self-test failed; waveform FPGA not programmed</b></p> <p>Le processeur n'a pas pu programmer le réseau FPGA (U1005) au démarrage. Problème matériel.</p>	<p>Carte processeur ou Carte mère Pour plus d'informations sur les erreurs 605 à 609, reportez-vous à rubrique <b>Dépannage - Recherche de problèmes</b>.</p>
606	<p><b>Self-test failed; waveform FPGA revision check failed</b></p> <p>Le processeur a tenté de lire l'enregistrement de la version dans le réseau FPGA (U1005) et a reçu une valeur incorrecte probablement en raison d'un réseau FPGA non programmé ou d'un échec de communication interne SPI.</p>	
607	<p><b>Self-test failed; waveform FPGA read back error</b></p> <p>Le processeur n'a pas pu écrire et relire un emplacement de test dans le réseau FPGA (U1005), probablement en raison d'un réseau FPGA non programmé ou d'un échec de communication interne SPI.</p>	
608	<p><b>Self-test failed; waveform FPGA revision check failed</b></p> <p>Le circuit FPGA (U1005) a échoué au contrôle de sécurité interne, probablement en raison de dysfonctionnements du réseau FPGA (tests 605 à 608), d'une image FPGA incorrecte ou d'un dispositif de sécurité défectueux (U1007). Il existe un autotest pour cette panne.</p>	
609	<p><b>Self-test failed; waveform FPGA security check failed</b></p> <p>Le circuit FPGA (U1005) a échoué au contrôle de sécurité interne, probablement en raison de dysfonctionnements du réseau FPGA (tests 605 à 608), d'une image FPGA incorrecte ou d'un dispositif de sécurité défectueux (U1007). Il existe un autotest pour cette panne.</p>	
610	<p><b>Self-test failed; main PLL not locked</b></p> <p>Le réseau FPGA (U1005) ne se verrouille pas sur l'oscillateur interne 10 MHz (U903 ou U905).</p>	Carte mère
611	<p><b>Self-test failed; FPGA PLL not locked</b></p> <p>Le réseau FPGA (U1005) ne se verrouille pas sur la puce de l'horloge interne d'échantillonnage (U906).</p>	Carte mère
612	<p><b>Self-test failed; Chan n, waveform memory PLL not locked</b></p> <p>La mémoire RAM des signaux de la voie indiquée (U1101 ou U1102) ne se verrouille pas sur son horloge.</p>	Carte mère
613	<p><b>Self-test failed; Chan n, waveform memory not initialized</b></p> <p>Échec d'initialisation de la mémoire RAM des signaux de la voie indiquée (U1101 ou U1102).</p>	Carte mère
615	<p><b>Self-test failed; modulation ADC offset too low (too high)</b></p> <p>Mesure interne du convertisseur A/N de l'ACOM hors limites.</p>	Carte mère

Erreur	Message et signification (série 33500)	Cause probable (série 33500)
616	<p><b>Self-test failed; modulation ADC reference too low (too high)</b></p> <p>Mesure interne par le convertisseur A/N de sa tension de référence (VRef) hors limites.</p>	Carte mère
620	<p><b>Self-test failed; Chan n, waveform memory test failed on idle</b></p> <p>Échec de démarrage du test de la mémoire des signaux, probablement en raison d'une erreur du réseau FPGA (U1005)</p>	Carte mère
621	<p><b>Self-test failed; Chan n, waveform memory test failed</b></p> <p>Échec du test de la mémoire RAM des signaux de la voie indiquée (U1101 ou U1102) ; le test consiste à écrire et à lire l'ensemble de la mémoire des signaux avec un modèle prédéterminé.</p>	Carte mère
625	<p><b>Self-test failed; Chan n, waveform DAC gain[idx] too low (too high)</b></p> <p>Sortie incorrecte du convertisseur de signal N/A (U1801 ou U1501). Le gain [idx] de 1 fait référence au test de la tension POS ; un gain [idx] de 2 fait référence au test de la tension NEG.</p>	Carte mère
630	<p><b>Self-test failed; Chan n, sub attenuator failure 0dB</b></p> <p>Sortie incorrecte à 0 dB du convertisseur de signal N/A d'écrêtage dans le convertisseur de signal N/A (U1801 ou U1501). Dans ce cas, le test 631 n'est pas exécuté.</p>	Carte mère
631	<p><b>Self-test failed; Chan n, sub attenuator &lt;-7,00 to 0,00&gt;dB too low (too high)</b></p> <p>Sortie hors limites du convertisseur de signal N/A d'écrêtage dans le convertisseur de signal N/A (U1801 ou U1501).</p>	Carte mère
635	<p><b>Self-test failed; Chan n, null DAC gain[idx] too low (too high)</b></p> <p>Sortie auxiliaire hors limites du convertisseur N/A (U1801 ou U1501) ou des circuits analogiques associés. Le gain [idx] de 1 fait référence au test de la tension POS ; un gain [idx] de 2 fait référence au test de la tension NEG.</p>	Carte mère
640	<p><b>Self-test failed; Chan n, offset DAC gain[idx] too low (too high)</b></p> <p>Sortie hors limites de la tension résiduelle du convertisseur N/A (U1702 ou U2002) ou des circuits associés. Pour la tension résiduelle du convertisseur N/A déphasé, les polarités [idx] sont inversées : un gain [idx] de 1 fait référence au test de la tension NEG ; un gain [idx] de 2 fait référence au test de la tension POS.</p>	Carte mère
650	<p><b>Self-test failed; Chan n, 0dB path failure expected 0dB, measured value dB</b></p> <p>Sortie hors limites de la propagation directe du signal (sans atténuateur) du convertisseur N/A à l'entrée du convertisseur A/N. Dans ce cas, le test détaillé de l'atténuateur 655 n'est pas exécuté.</p>	Carte mère

Erreur	Message et signification (série 33500)	Cause probable (série 33500)
655	<p><b>Self-test failed; Chan n, -8 dB pre attenuator path too low (too high)</b>  <b>Self-test failed; Chan n, -16 dB pre attenuator path too low (too high)</b>  <b>Self-test failed; Chan n, -24 dB pre attenuator path too low (too high)</b>  <b>Self-test failed; Chan n, -24 dB post attenuator path too low (too high)</b></p> <p>Dysfonctionnement du relais d'atténuateur spécifié, ou les circuits associés ne fournissent pas l'atténuation attendue.</p>	Carte mère

### Numéros et messages d'erreur des autotests (série 33600)

Une panne peut générer plusieurs messages d'erreur ; le premier doit être considéré comme la cause première de la panne. Certains messages d'erreur incluent un numéro de voie défectueuse (1 ou 2), indiqué sous la forme n dans les messages ci-dessous.

Erreur	Message et signification (série 33600)	Cause probable (série 33600)
601	<p><b>Self-test failed; real time clock settings lost</b></p> <p>Les paramètres de date/heure de l'horloge temps réel sont perdus, probablement parce que la batterie de l'horloge temps réel (RTC) est déconnectée ou déchargée (pile bouton sur la carte de la face avant). Cette erreur peut également se produire si la carte processeur est retirée et réinsérée dans la face avant. Cette erreur est détectée à la mise sous tension et signalée par l'autotest tant que le problème n'est pas résolu et que l'instrument n'est pas remis sous tension.</p>	Batterie RTC
602	<p><b>Self-test failed; keyboard processor not responding</b></p> <p>Un microprocesseur de la face avant ne fonctionne pas.</p>	Carte de la face avant
603	<p><b>Self-test failed; incorrect keyboard processor product ID</b></p> <p>Un microprocesseur de la face avant est défectueux.</p>	Carte de la face avant
604	<p><b>Self-test failed; FPGA temperature out of limits</b></p> <p>Le capteur de température du réseau FPGA (U301 sur la carte mezzanine) indique une température excessive.</p>	Carte mezzanine ou ventilateur
604	<p><b>Self-test failed; unknown CPU exception during temperature test</b></p> <p>Échec de la tentative de communication avec le capteur de température sur le réseau FPGA (U301 sur la carte mezzanine).</p>	Carte de la face avant

Erreur	Message et signification (série 33600)	Cause probable (série 33600)
605	<p><b>Self-test failed; front panel I2C communication to main board temp sensor failed</b></p> <p>Une communication de la face avant avec un capteur de température sur la carte mère ne fonctionne pas.</p>	Carte mère
605	<p><b>Self-test failed; main board temperature out of limits</b></p> <p>Un capteur de température de la carte mère indique une température excessive.</p>	Carte mère ou ventilateur
606	<p><b>Self-test failed; front panel processor ping failed</b></p> <p>La carte processeur a tenté de lire le code de version de la face avant et a reçu un zéro (0), probablement en raison d'un processeur de la face avant non programmé ou défectueux.</p>	Carte de la face avant
607	<p><b>Self-test failed; waveform FPGA not programmed</b></p> <p>Le processeur n'a pas pu programmer le réseau FPGA (U301 sur la carte mezzanine) au démarrage. Problème matériel.</p>	Carte de la face avant, carte mère ou carte mezzanine. Pour plus d'informations sur les erreurs 607 à 611, reportez-vous à rubrique <b>Dépannage - Recherche de problèmes</b> .
608	<p><b>Self-test failed; waveform FPGA revision check failed</b></p> <p>Le processeur a tenté de lire l'enregistrement de la version dans le réseau FPGA (U301 sur la carte mezzanine) et a reçu une valeur incorrecte probablement en raison d'un réseau FPGA non programmé ou d'un échec de communication interne SPI.</p>	
609	<p><b>Self-test failed; waveform FPGA read back error</b></p> <p>Le processeur n'a pas pu écrire et relire un emplacement de test dans le réseau FPGA (U301 sur la carte mezzanine), probablement en raison d'un réseau FPGA non programmé ou d'un échec de communication interne SPI.</p>	
610	<p><b>Self-test failed; waveform FPGA error</b></p> <p>Le processeur n'a pas pu écrire et relire des valeurs du réseau FPGA en raison d'une panne matérielle du réseau FPGA (U301 sur la carte mezzanine), ou probablement en raison d'un réseau FPGA non programmé ou d'un échec de communication interne SPI.</p>	
611	<p><b>Self-test failed; waveform FPGA authentication failed</b></p> <p>Le processeur n'a pas pu vérifier la programmation correcte du réseau FPGA et le contrôle de sécurité.</p>	Carte mezzanine. Pour plus d'informations sur les erreurs 607 à 611, reportez-vous à rubrique <b>Dépannage - Recherche de problèmes</b> .
612	<p><b>Self-test failed; main PLL not locked</b></p> <p>Le circuit à boucle de verrouillage de phase sur la carte mezzanine n'a pas pu verrouiller l'oscillateur de référence 10 MHz interne.</p>	Carte mezzanine



Erreur	Message et signification (série 33600)	Cause probable (série 33600)
613	<p><b>Self-test failed; FPGA not locked to 250MHz</b></p> <p>Le circuit à boucle de verrouillage de phase sur la carte mezzanine n'a pas pu se verrouiller à 250 MHz.</p>	Carte mezzanine
614	<p><b>Self-test failed; waveform memory PLL not locked</b></p> <p>Le circuit à boucle de verrouillage de phase sur la carte mezzanine n'a pas pu se verrouiller à la fréquence de mémoire des signaux.</p>	Carte mezzanine
615	<p><b>Self-test failed; waveform memory not initialized</b></p> <p>La mémoire des signaux ne s'est pas correctement initialisée.</p>	
616	<p><b>Self-test failed; modulation ADC offset too low</b></p> <p>Le circuit du convertisseur analogique/numérique de modulation externe n'a pas pu mesurer correctement une tension de référence de la masse.</p>	Carte mère
616	<p><b>Self-test failed; modulation ADC offset too high</b></p> <p>Le circuit du convertisseur analogique/numérique de modulation externe n'a pas pu mesurer correctement une tension de référence de la masse.</p>	Carte mère
617	<p><b>Self-test failed; modulation ADC reference too low</b></p> <p>Le circuit du convertisseur analogique/numérique de modulation externe n'a pas pu mesurer correctement une tension de référence.</p>	Carte mère
617	<p><b>Self-test failed; modulation ADC reference too high</b></p> <p>Le circuit du convertisseur analogique/numérique de modulation externe n'a pas pu mesurer correctement une tension de référence.</p>	Carte mère
620	<p><b>Self-test failed; Chan n, waveform memory test failed on idle</b></p> <p>Échec de démarrage du test de la mémoire des signaux, probablement en raison d'une erreur du réseau FPGA (U301).</p>	Carte mezzanine
621	<p><b>Self-test failed; Chan n, waveform memory test failed</b></p> <p>Échec du test de la mémoire RAM des signaux de la voie indiquée (U601 et U602 ou U701 et U702) ; le test consiste à écrire et à lire l'ensemble de la mémoire des signaux avec un modèle prédéterminé.</p>	Carte mezzanine
625	<p><b>Self-test failed; Chan n, waveform DAC gain[idx] too low (too high)</b></p> <p>Sortie incorrecte du convertisseur de signal N/A (U1001 ou U1101 sur la carte mezzanine). Le gain [idx] de 1 fait référence au test de la tension positive ; un gain [idx] de 2 fait référence au test de la tension négative. Teste également U901 et U902 pour la voie 1 ou U1401 et U1402 (pour la voie 2) sur la carte mère.</p>	Carte mezzanine ou carte mère

Erreur	Message et signification (série 33600)	Cause probable (série 33600)
626	<p><b>Self-test failed; CH1 waveform DAC is not synchronized properly</b></p> <p>Le convertisseur analogique/numérique de signaux (U1001) sur la voie 1 ne peut se verrouiller en fréquence sur les signaux d'horloge.</p>	Carte mezzanine
626	<p><b>Self-test failed; CH2 waveform DAC is not synchronized properly</b></p> <p>Le convertisseur analogique/numérique de signaux (U1101) sur la voie 2 ne peut se verrouiller en fréquence sur les signaux d'horloge.</p>	Carte mezzanine
626	<p><b>Self-test failed; Sync waveform DAC is not synchronized properly</b></p> <p>Le convertisseur analogique/numérique de signaux (U1201) sur la voie Sync ne peut se verrouiller en fréquence sur les signaux d'horloge.</p>	Carte mezzanine
630	<p><b>Self-test failed; Chan n, sub attenuator failure 0dB</b></p> <p>Sortie incorrecte à 0 dB du convertisseur de signal N/A d'écrêtage dans le convertisseur de signal N/A (U1001 – voie 1 ou U1101 – voie 2). Ce test dépend également du circuit d'atténuation des signaux sur la carte mère (pour la voie 1, cela signifie U1401, U1402, les atténuateurs de relais K1501 - K1503, K1701 - K1704 et le circuit de l'amplificateur). Dans ce cas, le test 631 n'est pas exécuté.</p>	Carte mezzanine (convertisseur analogique/numérique) ou carte mère (chaîne d'atténuateur de signaux).
631	<p><b>Self-test failed; Chan n, sub attenuator xx dB</b></p> <p>Sortie hors limites du convertisseur de signal N/A d'écrêtage dans le convertisseur de signal N/A (U1001 ou U1101).</p>	Carte mezzanine
635	<p><b>Self-test failed; Chan n, null DAC gain xx</b></p> <p>Un circuit d'annulation CC (U1404, U1405) n'a pas pu produire la variation de tension attendue.</p>	Carte mère
640	<p><b>Self-test failed; Chan n, offset DAC gain xx</b></p> <p>Un circuit de génération de signaux de tension résiduelle CC (U1609, U1610) n'a pas pu produire la variation de tension attendue.</p>	Carte mère
650	<p><b>Self-test failed; 0dB path failure channel n expected 0dB, measured yy dB</b></p> <p>Sortie hors limites de la propagation directe du signal (sans atténuateur) du convertisseur N/A à l'entrée du convertisseur A/N. Sortie incorrecte à 0 dB du convertisseur de signal N/A (U1001 – voie 1 ou U1101 – voie 2). Ce test dépend également du circuit d'atténuation des signaux sur la carte mère (pour la voie 1, cela signifie U1401, U1402, les atténuateurs de relais K1501 - K1503, K1701 - K1704 et le circuit de l'amplificateur).</p> <p>Dans ce cas, le test détaillé de l'atténuateur 655 n'est pas exécuté.</p>	Carte mezzanine, convertisseur numérique/analogique de signaux ou carte mère

Erreur	Message et signification (série 33600)	Cause probable (série 33600)
655	<p><b>Self-test failed; Chan n, -8 dB pre attenuator path too low (too high)</b>  <b>Self-test failed; Chan n, -16 dB pre attenuator path too low (too high)</b>  <b>Self-test failed; Chan n, -24 dB pre attenuator path too low (too high)</b>  <b>Self-test failed; Chan n, -24 dB post attenuator path too low (too high)</b></p> <p>Dysfonctionnement du relais d'atténuateur spécifié, ou les circuits associés ne fournissent pas l'atténuation attendue.</p>	Carte mère
660	<p><b>Self-test failed; Channel n: xx dB pre/post attenuator relay inoperative</b></p> <p>L'autotest n'a pas pu modifier l'amplitude de signal avec les atténuateurs de relais indiqués.</p>	Carte mère
661	<p><b>Self-test failed; EEPROM access failed</b></p> <p>La carte mère n'a pas pu lire une puce mémoire (U2) sur la carte de la face avant.</p>	Carte mère

## Pièces détachées

### ATTENTION

Utilisez toujours des techniques antistatiques pour manipuler ou réparer des ensembles.

Le tableau ci-dessous répertorie les ensembles de rechange de l'instrument :

Référence	Description
34401-86020	Kit antichocs
34401-45021	Poignée
33220-84101	Capot
1990-3263	Codeur (série 33500)
1990-3728	Codeur (série 33600)
35220-87401	Bouton
33521-80001	Clavier pour modèles 1 voie
33522-80001	Clavier pour modèles 2 voies
2090-0977	Écran (série 33500)
2090-1051	Écran (série 33600)
1250-3569	Connecteurs BNC de la face avant

Référence	Description
33521-80002	Face avant du modèle 33521A
33522-80002	Face avant du modèle 33522A
33520-80001	Face avant pour modèles 1 voie 335xxB
33520-80002	Face avant pour modèles 2 voies 335xxB
33621-80002	Face avant pour modèles 1 voie série 33600
33622-80002	Face avant pour modèles 2 voies série 33600
33522-66502	Carte de la face avant (série 33500)
1252-8483	Connecteur USB
1253-4669	Connecteur LAN (série 33500)
1254-0795	Connecteur LAN (série 33600)
53200-61608	Filtre de ligne (série 33500)
5041-5250	Filtre de ligne (série 33600)
33250-68501	Ventilateur (série 33500)
5041-5244	Kit de ventilateurs (série 33600)
1420-0356	Batterie (sur la face avant) CR2032
53200-80002	Alimentation et capot* (série 33500)
5041-5252	Blindage d'alimentation (série 33600 uniquement) :
5041-5256	Alimentation* (série 33600 uniquement) :

\* Les modèles de la série 33500 incluent un fusible 15 A/250 V à sorties perpendiculaires. Il est déconseillé de remplacer le fusible.

\* Les modèles de la série 33600 contiennent deux fusibles 3,15 A/250 V à sorties perpendiculaires. Il est déconseillé de remplacer le fusible.

## Démontage - Série 33500

Cette section décrit la procédure de démontage de l'instrument.

### Outillage nécessaire

Les outils suivants sont nécessaires pour démonter l'instrument.

- Tournevis Torx T15 (pour la plupart des opérations)
- Tournevis Torx T8 (pour la dépose de la face avant)
- Tournevis plat et Posidrive

- Clé à douille 14 mm, arbre creux (connecteurs BNC de la face arrière)
- Clé à douille 7 mm (connecteur GPIB de la face arrière)

**AVERTISSEMENT**

**Seules des personnes qualifiées, formées à la maintenance et conscientes des risques d'électrocution encourus peuvent déposer les capots de l'instrument. Débranchez toujours le cordon d'alimentation et tous les circuits externes avant de déposer le capot de l'instrument. Certains circuits sont sous tension, même si l'interrupteur d'alimentation est coupé.**

**Débranchez systématiquement l'ensemble des entrées, des cordons et des câbles avant de démonter l'instrument.**

### Procédure générale de démontage

1. Coupez l'alimentation. Débranchez tous les câbles de l'instrument.
2. Faites pivoter la poignée vers le haut et tirez-la.



3. Déposez les amortisseurs de l'instrument.



4. Desserrez les deux vis imperdables (entourées en rouge ci-dessous) du cadre arrière et déposez le cadre.



5. Faites glisser le capot de l'instrument vers l'extérieur.

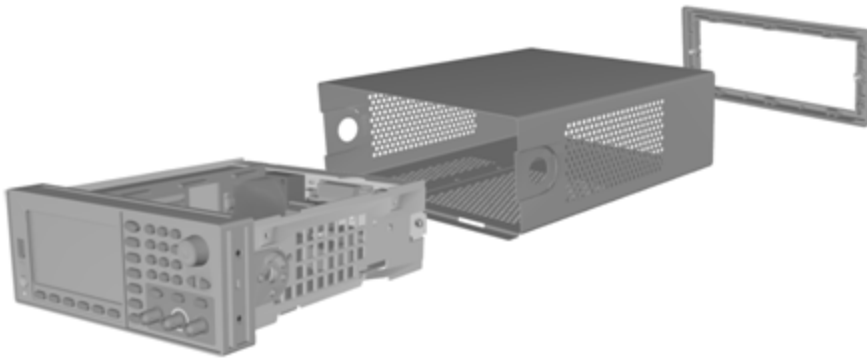

De nombreuses procédures de maintenance peuvent être désormais effectuées sans aucun démontage supplémentaire. Les procédures de dépannage et de maintenance qui requièrent l'application de l'alimentation peuvent être effectuées avec l'instrument dans cet état de démontage.

**AVERTISSEMENT**

***RISQUE D'ÉLECTROCUTION.** Seules des personnes qualifiées, formées à la maintenance et conscientes des risques d'électrocution encourus sont autorisées à démonter les capots de l'instrument. Des tensions dangereuses peuvent être présentes lorsque les capots de l'instrument sont déposés.*

### Démontage des principaux composants

1. Déposez la carte processeur. Retournez l'instrument. Démontez la vis T-8 de fixation de la carte processeur. Appuyez sur les languettes du connecteur de la carte processeur et faites glisser la carte pour dégager le connecteur. Tirez sur la carte processeur pour l'extraire.

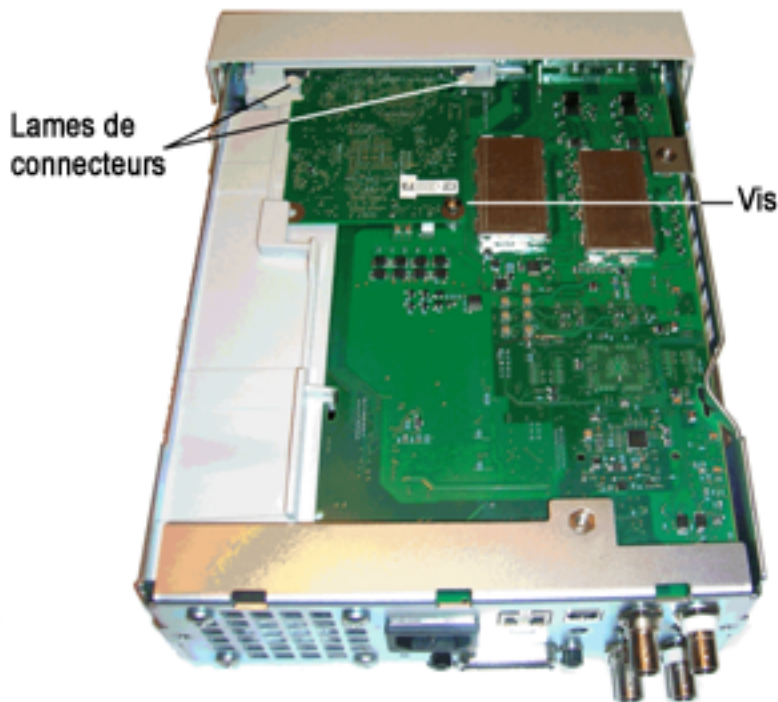

2. Déposez le sous-ensemble de la face avant. Retirez la vis T15 de fixation de la carte mère. Appuyez sur le verrou à gauche de la face avant et sur celui du capot de l'alimentation à droite de la face avant. Poussez les côtés du châssis métallique vers le centre pour libérer les goujons sur les côtés de la face avant. Tirez délicatement sur l'ensemble de la face avant pour le sortir du châssis. Notez que la face avant comporte un connecteur électrique relié à la carte mère. Veillez à ne pas endommager le connecteur.

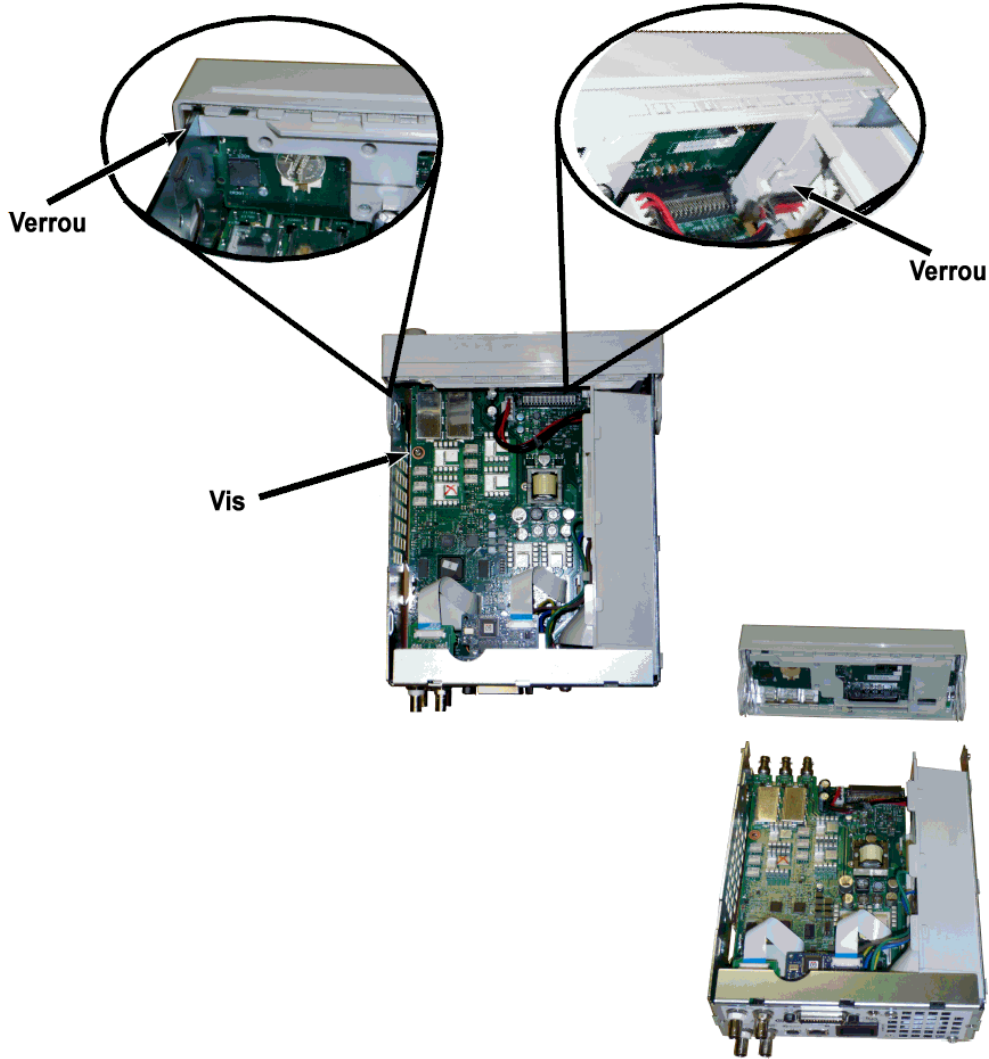

3. Retirez la carte mère. Débranchez le connecteur d'alimentation de la carte mère. Débranchez les câbles plats  **GPIB**  et  **Oscillator In** . Débranchez le câble d'alimentation du ventilateur de la carte mère. Desserrez et retirez les écrous de fixation des connecteurs BNC  **Modulation In**  et  **Ext Trig**  sur la face arrière. Retirez la vis sous la carte GPIB qui fixe la carte mère au châssis. Faites glisser la carte mère vers l'avant de l'instrument pour libérer les languettes du capot de l'alimentation. Sortez la carte mère vers le haut.

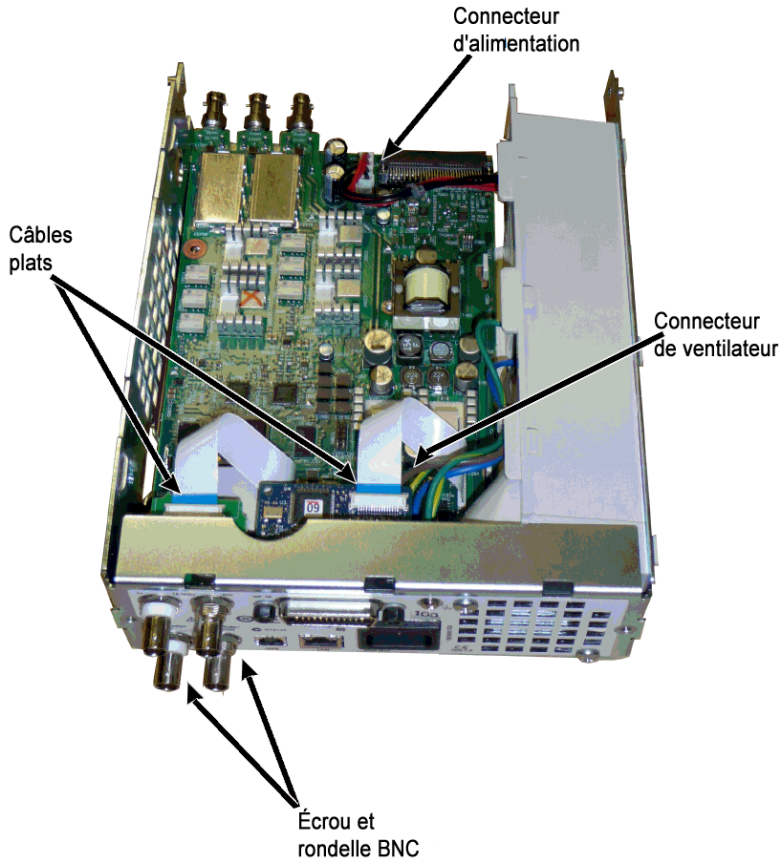

4. Déposez l'alimentation. Débranchez l'entrée de l'alimentation de la carte d'alimentation (fils bleu et marron). Débranchez le connecteur de masse vert sur la carte d'alimentation. Retirez la vis de fixation du capot de l'alimentation au châssis. Faites glisser l'alimentation vers l'avant de l'instrument et déposez-la.

**AVERTISSEMENT**

Remontez toujours le fil de masse vert sur l'alimentation avant d'utiliser l'instrument.

5. Il est possible de démonter les autres ensembles du châssis, si nécessaire.



## Démontage de la face avant

1. Tirez sur le bouton. Retirez les 6 vis T8 de fixation du support de la face avant à l'ensemble de la face avant. Tirez le support vers le haut pour l'extraire.

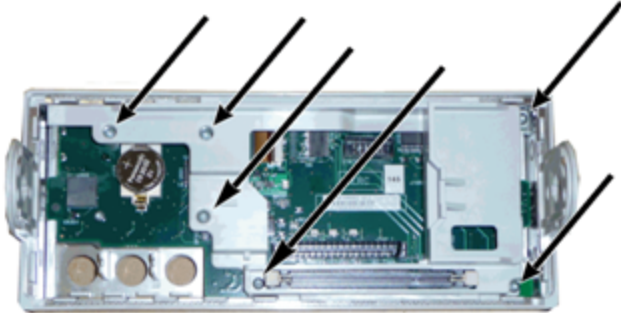

2. Débranchez le câble plat de l'écran de la carte de la face avant. Démontez les vis T8 de fixation de la carte de la face avant à l'ensemble de la face avant. Soulevez la carte à circuit imprimé.

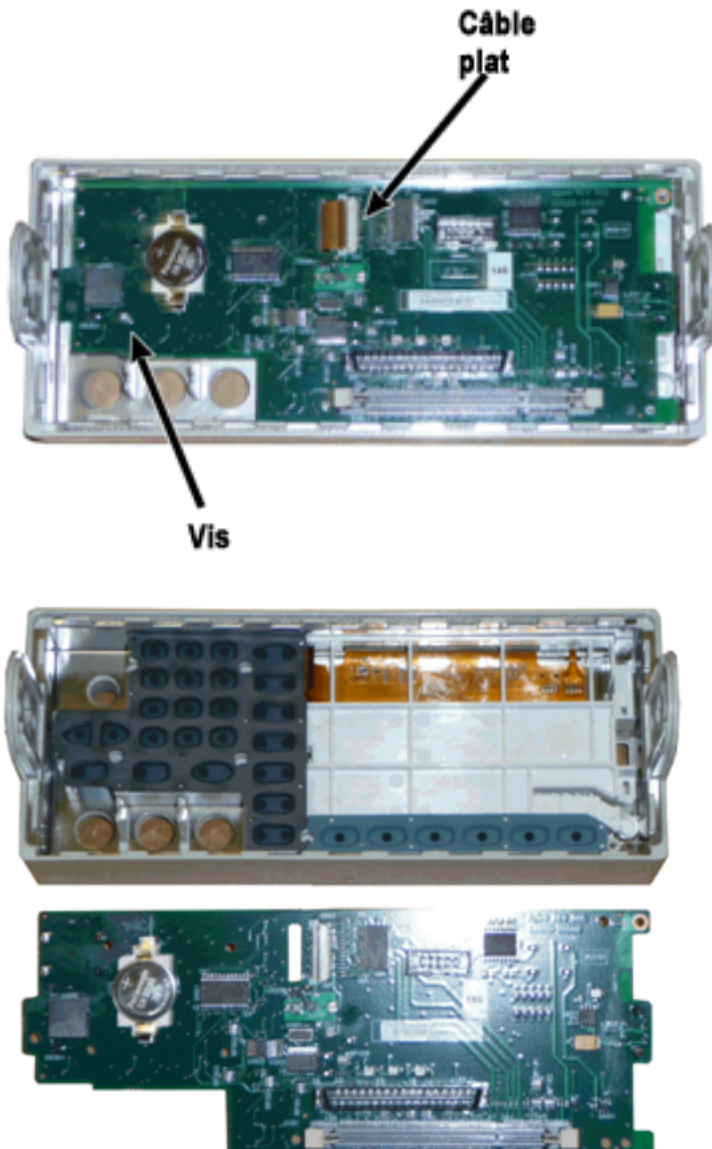

3. Il est alors possible de soulever tous les autres ensembles de la face avant pour les extraire du boîtier de la face avant.

## Démontage - Série 33600

Cette section décrit la procédure de démontage de l'instrument.

### Outillage nécessaire

Les outils suivants sont nécessaires pour démonter l'instrument.

- Tournevis Torx T15 (pour la plupart des opérations)
- Tournevis Torx T8 (pour la dépose de la face avant)

- Tournevis plat et Posidrive
- Clé à douille 14 mm, arbre creux (connecteurs BNC de la face arrière)
- Tournevis Torx T10 (connecteur GPIB de la face arrière)

**AVERTISSEMENT**

**Seules des personnes qualifiées, formées à la maintenance et conscientes des risques d'électrocution encourus peuvent déposer les capots de l'instrument. Débranchez toujours le cordon d'alimentation et tous les circuits externes avant de déposer le capot de l'instrument. Certains circuits sont sous tension, même si l'interrupteur d'alimentation est coupé.**

**Débranchez systématiquement l'ensemble des entrées, des cordons et des câbles avant de démonter l'instrument.**

### Procédure générale de démontage

1. Coupez l'alimentation. Débranchez tous les câbles de l'instrument.
2. Faites pivoter la poignée vers le haut et tirez-la.



3. Déposez les amortisseurs de l'instrument.



4. Desserrez les deux vis imperdables (entourées en rouge ci-dessous) du cadre arrière et déposez le cadre.



5. Faites glisser le capot de l'instrument vers l'extérieur.

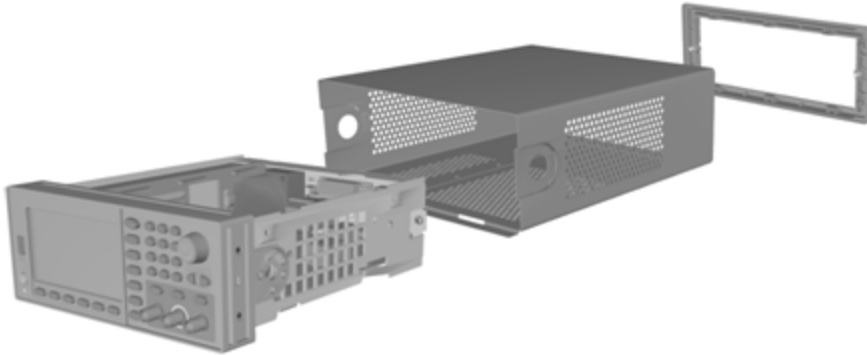

De nombreuses procédures de maintenance peuvent être désormais effectuées sans aucun démontage supplémentaire. Les procédures de dépannage et de maintenance qui requièrent l'application de l'alimentation peuvent être effectuées avec l'instrument dans cet état de démontage.

**AVERTISSEMENT**

*RISQUE D'ÉLECTROCUTION. Seules des personnes qualifiées, formées à la maintenance et conscientes des risques d'électrocution encourus sont autorisées à démonter les capots de l'instrument. Des tensions dangereuses peuvent être présentes lorsque les capots de l'instrument sont déposés.*

## Démontage des principaux composants

### Pour retirer la carte à circuit imprimé des faces avant et arrière

1. Retirez les deux vis situées à l'avant du poste d'alimentation qui maintient ce dernier en place.

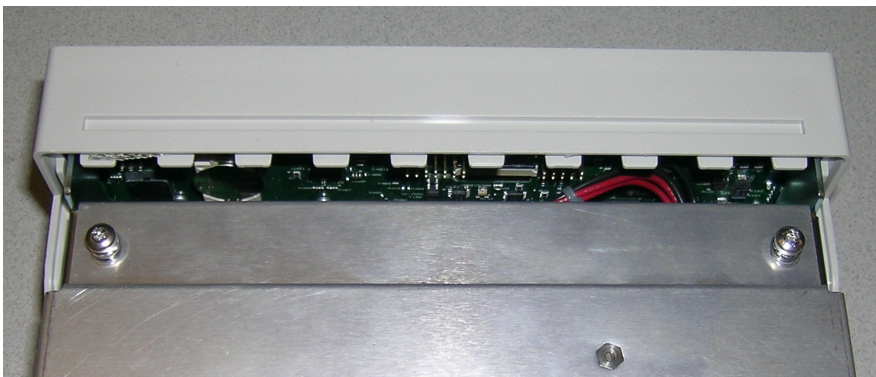

## Entretien et réparation - Introduction

2. Inclinez le poste d'alimentation vers le haut et faites-le passer par dessus le bord du châssis. Pose-le ensuite à l'envers sur votre paillasse, comme indiqué ci-dessous.

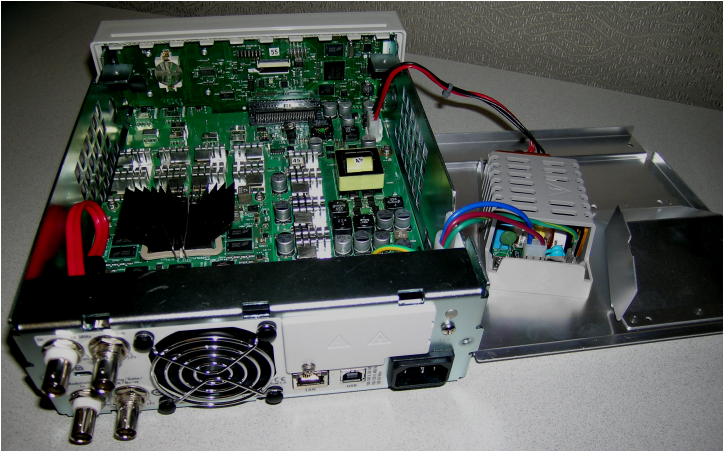

3. Retirez les deux vis de la carte mère. Ces dernières sont situées directement sous les deux vis que vous avez retirées à l'étape 1.
4. Enfoncez les côtés du châssis vers l'intérieur et faites glisser la face avant vers l'avant pour l'extraire.
5. Débranchez le câble de connexion de la carte de la face avant à l'écran en soulevant le levier du connecteur pour libérer le câble.
6. Retirez les sept vis de fixation de la carte à circuit imprimé au plastique de la face avant.

## Pour retirer la carte mère

1. Si l'option GPIB est installée, retirez-la comme décrit [ici](#).
2. Déposez la face avant comme décrit ci-dessus.
3. Pour accéder à la carte mère, soulevez le poste d'alimentation et retirez-le de l'instrument. Vous pouvez l'insérer dans la rainure du châssis de l'instrument, ou la dégager complètement et la mettre sur votre paillasse, comme décrit ci-dessous.

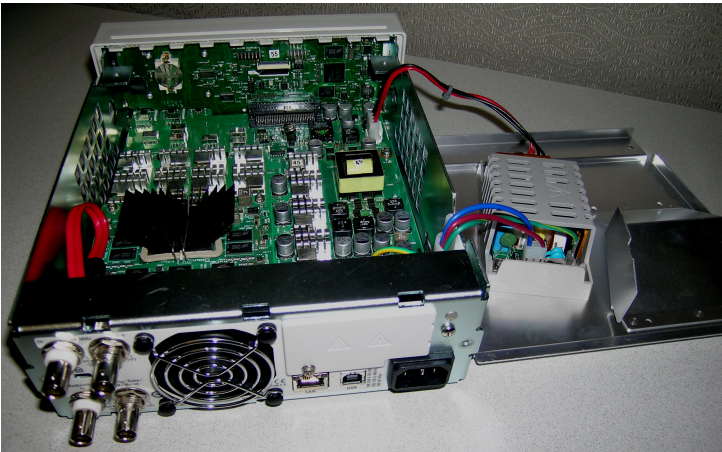

4. Retirez le câble doté des fils rouge et noir du connecteur situé à l'avant de la carte mère.
5. Retirez les autres câbles (du module d'entrée d'alimentation secteur) à l'arrière de l'alimentation.
6. Débranchez le câble rouge et le câble du ventilateur à l'arrière de la carte mère.
7. Retirez la vis de fixation de la carte mère au châssis à l'arrière de l'instrument.
8. Ôtez les rondelles frein et les écrous des deux connecteurs BNC situés au bas de la face arrière.
9. Faites glisser légèrement la carte mère pour libérer les crochets latéraux du châssis, puis tirez-la vers le haut et l'extérieur pour l'extraire.

## Remplacement de la batterie

Cette section décrit la procédure de remplacement de la batterie sur la face avant de l'instrument.

**AVERTISSEMENT**

**Seules des personnes qualifiées, formées à la maintenance et conscientes des risques d'électrocution encourus peuvent déposer les capots de l'instrument. Débranchez toujours le cordon d'alimentation et tous les circuits externes avant de déposer le capot de l'instrument. Certains circuits sont sous tension, même si l'interrupteur d'alimentation est coupé.**

**Débranchez systématiquement l'ensemble des entrées, des cordons et des câbles avant de démonter l'instrument.**

### Outillage nécessaire

- Tournevis Torx T20 (pour la plupart des opérations de démontage)
- Petit tournevis à tête plate (pour l'extraction)

## Procédure

(Les images ci-dessous ont été fournies gracieusement par Keystone Electronics Corp.)

1. Mettez l'appareil hors tension et débranchez tous les cordons de mesure et autres câbles, notamment le cordon d'alimentation, avant de poursuivre.
2. Suivez la **procédure de démontage de la série 33500** ou la **procédure de démontage de la série 33600** pour démonter l'instrument.
3. Recherchez la batterie sur la face avant et placez la pointe du tournevis sous la batterie, comme indiqué.

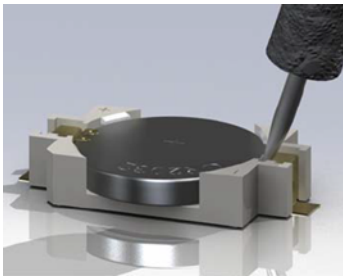

4. À l'aide du tournevis, retirez la batterie de son compartiment.

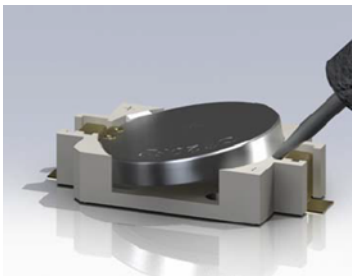

5. Retirez la batterie et mettez-la au rebut ou recyclez-la conformément à l'ensemble des réglementations en vigueur.
6. Positionnez la batterie neuve dans son compartiment, le côté + orienté vers le haut. Appuyez doucement sur la batterie pour la caler dans le compartiment.

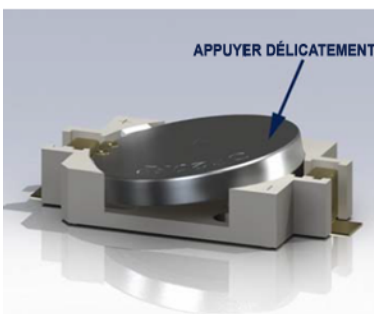

7. Remontez entièrement l'instrument avant de brancher les câbles ou les cordons.

La procédure de remplacement de la batterie est terminée.



## Installation de l'interface GPIB en option

**AVERTISSEMENT**

Cette procédure ne doit être effectuée que par des techniciens de maintenance qualifiés. Mettez l'appareil hors tension et débranchez tous les cordons de mesure et autres câbles, notamment le cordon d'alimentation, avant de poursuivre.

### Outillage nécessaire

Un pilote T10 Torx est nécessaire pour exécuter cette procédure.

### Procédure d'installation

1. Mettez l'appareil hors tension et débranchez tous les cordons de mesure et autres câbles, notamment le cordon d'alimentation, avant de poursuivre.
2. À l'aide de la clé Torx, retirez la vis du couvercle GPIB. Conservez la vis pour une utilisation ultérieure dans cette procédure. Puis, déposez le couvercle en le faisant glisser vers la gauche.

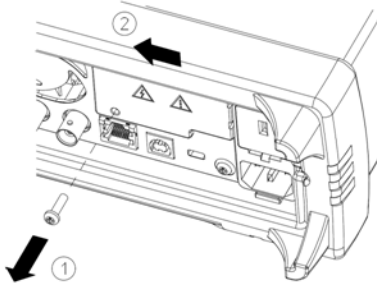

**AVERTISSEMENT**

Conservez le couvercle GPIB

Après avoir installé l'option GPIB, conservez son couvercle pour une utilisation ultérieure au cas où vous auriez besoin de supprimer l'option. Vous ne devez jamais raccorder l'appareil à l'alimentation secteur ou à des entrées sur les bornes de mesure sans vous être préalablement assuré que le module ou le couvercle GPIB recouvre parfaitement l'ouverture de la face arrière.

3. À l'intérieur de l'appareil, recherchez le connecteur qui correspond au câble fixé au module GPIB.

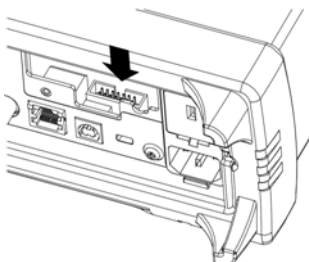

4. Pliez le câble afin qu'il s'étende au-dessus de la carte de circuit. Fixez le câble au connecteur qui a été localisé à l'étape précédente.

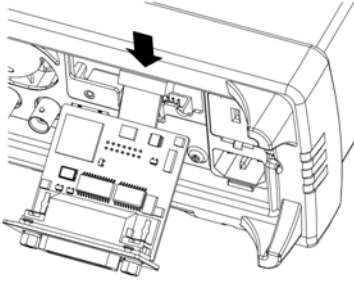

5. Insérez le module dans l'unité et faites glisser la carte GPIB vers la droite afin qu'elle s'aligne sur l'enveloppe métallique de l'instrument. À l'aide de la vis qui a été retirée ci-dessus, mettez la plaque GPIB en place.

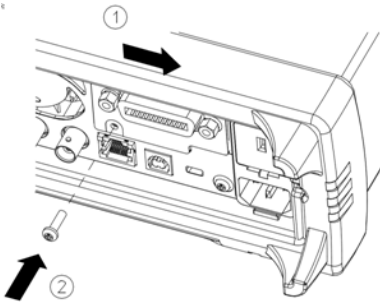

La procédure d'installation du module GPIB est terminée.



# Index

---

\*  
\*CLS 306

\*ESE 307

\*ESR? 307

\*IDN? 308

\*OPC 309

\*OPC? 309

\*OPT? 310

\*PSC 310

\*PSC? 310

\*RCL 311

\*RST 312

\*SAV 311

\*SRE 312

\*STB? 313

\*TRG 313

\*TST? 314

\*WAI 314

**A**

abandonner  
l'étalonnage 499,  
541

ABORt 204

Activation de l'état des  
événements 310

ADDRess 396

Adresse matérielle 410

ADVance 281

Aide 43

Aide-mémoire 443

alimentations 571-572

ALL 237, 316-317, 333,  
339, 399

AM 99, 205-208, 211,  
226, 229, 262,  
265, 273, 276,  
359, 362, 367, 370

Amplitude 35

AMPLitude 387

Amplitude CA 493, 504,  
510, 526, 546, 556

Amplitude de sortie 35

ANGLE 426

ANGLE 424

APPLy 213-217, 219,  
221-223

ARB2 245

arbitraire 441

ARBitrary 214, 246,  
280-283, 285-  
286, 299-303,  
334, 353, 373, 426

ARBRate 255

Atténuation d'entrée 318

Atténuation de la modu-  
lation 318

ATTRibute 248-249

AUTO 374, 436

autotest 500, 542, 572,  
577, 583

Autotest 314

autotest à la mise sous  
tension 583

AVERAge 248

**B**

baie 45

BALance 299-301

balayage 53, 56

balayage en  
fréquence 53

BANDwidth 287

base de temps 163, 500,  
542

base de temps  
interne 492, 500,  
526, 542

base de  
temps, externe 163

batterie 603

BEEPer 394-395

BORDer 266

BOTH 290, 294

BPSK 208, 211, 225-  
226, 229, 262,  
265, 273, 276,  
359, 362, 367, 370

BRATe 287

---

BURSt 233-236

BUS 199

## C

CALibration 237-241

Caractères de fin de com-  
mande SCPI 198

caractéristiques 78

carré 438

CATalog 252, 325, 333-  
335, 398

CD-ROM 21

CDIRectory 336

CENTer 268

CFACTOR 248

clavier numérique 28

CLEAR 252

CLEAR 254, 256

CLICK 395

CLS 199, 306, 468

CODE 238

COMBine 242

Commandes courantes  
IEEE-488 304

COMMunicate 396, 405-  
414

CONDition 381, 383

configuration 57, 461

Configuration d'un train  
d'impulsions 41

configuration de  
l'instrument 57

configuration de  
l'interface  
distante 65

configuration de la  
sortie 79

configuration des  
voies 79

Configuration du réseau  
local 65, 405

consignes  
d'utilisation 20

Consignes de sécurité 3,  
5

Consignes, sécurité 3, 5

CONTinuous 316

CONTrol 405

Conventions  
syntaxiques 196

convertisseur ana-  
logique/numérique  
interne 501, 543

COPY 336-337

COUNT 238, 400, 419

COUPLE 268-270, 371-  
373, 430

CURREnt 375

CYCLE 323

## D

DAC 246

DATA 245-246, 248-  
250, 252, 284,  
288, 304, 334,  
338-339, 341

DATE 397

DC 215

DCYCLE 291, 297, 365

déclencher un  
balayage 56

déclencher une rafale 56

DELAy 419

DELEte 326, 337, 398-  
399

Demande de service  
activation 310

démontage 592, 598

dépannage 572, 577

DEPTH 205

DESCription 399

DESired 321

DEVIation 259, 357,  
364-365

Device Clear 200

DHCP 406

didacticiel 179, 500, 542

DISPlay 253-257

DNS 407

DOMain 407

DOWNload 338

DSSC 206  
DWELL 318  
**E**  
E/S 468  
    file d'attente 468  
écran 27  
Éditeur de signaux 165  
éditeur de signaux arbitraires 67  
éditeur de signaux intégré 67  
Éditeur de signaux intégré 165  
Effacement d'état 468  
Effacement de l'état à la mise sous tension 310  
En attente de déclenchement 313  
ENABLE 320, 382, 384, 396  
End-Or-Identify 198  
enregistrer la configuration 57  
entretien 482  
erreurs 515, 564  
erreurs d'étalonnage 515, 564  
ERRor 355, 397, 399-400

ESE 307  
ESR? 307  
étalonnage 483, 485, 488, 491-493, 495, 497-501, 504, 506-507, 509-510, 513-514, 517, 519, 522, 524, 526, 528, 532, 536, 541-543, 546, 548, 551, 553-554, 556, 558, 561, 563  
EVENT 382, 384  
exemples de programmes 437  
Ext Trig BNC 420  
EXTernal 199  
**F**  
face arrière 29  
face avant 26-28, 59  
Factory Reset 312  
FEED 242  
FIFO 468  
File d'attente 468  
    E/S 468  
FM 99, 208, 211, 226, 229, 259-262, 265, 273, 276, 359, 362, 367, 370  
FNAMe 338

FOCUS 254  
Fonction interne 200  
fonctions 78  
FORMat 245, 266, 304  
FREE 252  
fréquence 500, 542  
Fréquence 34, 114, 122, 131, 142, 148, 154, 485, 491, 519, 524  
fréquence d'échantillonnage 285, 371-373  
Fréquence de sortie 34, 114, 122, 131, 142, 148, 154, 485, 491, 519, 524  
FREQuency 207, 260, 267-272, 282, 319, 323, 358, 366, 388  
FSK 49, 112  
FSKey 208, 211, 226, 229, 262, 265, 272-273, 276, 359, 362, 367, 370  
FUNction 208, 261, 279-288, 290-303, 359, 367, 373, 389  
**G**  
GAIN 300  
GATE 233

---

GATeway 408  
GPIB 21, 396, 468

## H

HCOPy 304  
HIGH 431, 433  
HNAMe 320  
HOLD 292  
HOSTname 409  
HTIMe 392

## I

IDENTify 320  
IDN? 308  
IMMediate 199, 317,  
394, 404  
impédance 47  
impédance de sortie 47,  
503, 509, 545, 555  
impulsion 94  
Impulsion 41  
impulsion,train  
d'impulsions 440  
Informations de  
sécurité 2  
INITiate 316-317  
INSTall 400  
Interface Web 22  
INTernal 207-208, 225,  
233, 260-261,

273, 358-359,  
366-367, 388-389

Interrogation série 313  
IPADdress 410  
IQ Player 145

## K

Keysight IO Libraries  
Suite 21

## L

LAN 405-414  
langage de commande  
aide-mémoire 443  
commandes par sous-  
système 202  
langage SCPI  
présentation 196  
Langage SCPI 196  
langage de commande  
commandes par sous-  
système 6  
LEADing 294  
LEVel 419  
LICense 398-400  
LIMit 433-434  
LIST 318-319, 340  
liste de fréquences 441  
LOAD 339-340, 344  
Local key 254

---

LOCK 401-402  
LOW 431, 433  
LXI 320-322

## M

MAC 410  
MARKer 323-324  
MDIRectory 336  
MDNS 320-321  
MEMory 325-327  
menus 59  
menus de la face  
avant 59  
Message disponible 312-  
313  
messages d'erreur 515,  
564  
Messages d'erreur 468  
Messages d'erreur, triés  
par code  
d'erreur 468  
MMEMory 333-336,  
336-342  
MODE 234, 269-270,  
345, 347, 372  
modulation 48  
MODulation 354  
modulation  
d'amplitude 99  
modulation de  
fréquence 99

---

modulation de largeur  
d'impulsion  
(PWM) 51

Modulation de  
phase 106

Modulation par dépla-  
cement de fré-  
quence 112

modulation SUM 119

montage dans une  
baie 45

mot de passe 488, 522

MOVE 341

## N

NAME 401

NCYCles 235

NOISe 216, 287

NStates 325

## O

Octet d'état 312

OFFSet 269, 299, 301,  
372, 435

OPC 199, 309

OPC? 309

OPERation 381-382

OPT? 310

Option GPIB 605

OUTPut 343-351

OWNer 401

---

## P

Paramètres 198

Requêtes 198

Paramètres  
booléens 199

Paramètres de chaînes de  
caractères  
ASCII 200

Paramètres DEF 197

Paramètres discrets 199

Paramètres  
numériques 199

PERiod 233, 282, 293,  
298

PHASe 225, 236, 286,  
352-355

pièces 591

pièces détachées 591

plage -24 dB 497, 506,  
513, 548, 558

plage -8 dB 495, 507,  
532, 536, 551,  
553, 563

plage 1 Vpp 528

planéité 495, 497, 506-  
507, 513-514,  
528, 532, 536,  
548, 551, 553,  
558, 561, 563

PM 106, 208, 211, 226,  
229, 262, 265,  
273, 276, 357-

---

359, 362, 367, 370

Poignée 33

Poignée de transport 33

POINT 324

POINTs 249, 283, 319

POLarity 233, 345, 348

PRBS 217, 288, 290

Première entrée, pre-  
mière sortie 468

Préréglage de  
l'instrument 395

Préréglage usine 395

Présentation 196

langage SCPI 196

Présentation de  
l'instrument 24

Présentation du sous-sys-  
tème  
SINITiate 316

Présentation du sous-sys-  
tème STATus 378

Présentation du sous-sys-  
tème SUM 385

Présentation du sous-sys-  
tème SWEep 391

Présentation du sous-sys-  
tème TRIGger 137,  
418

Présentation du sous-sys-  
tème  
VOLTage 426

PRESet 383



---

PRNoise 287  
PROMpt 412  
PSC 310  
PTPeak 249, 284  
PULSe 219, 255, 291-295  
PWM 51, 208, 211, 226, 229, 262, 265, 273, 276, 359, 362, 364-367, 370

## Q

QUESTionable 383-384

## R

rafale 55-56  
RAMP 221, 296  
rampe 439  
RANGe 436  
rapport cyclique 291, 297, 365  
Rapport cyclique 40  
Rapport cyclique d'un signal carré 40  
RATE 225, 255, 371-372  
RATio 270, 373  
RDIRECTory 336  
RECall 327  
Récapitulatif des données suspectes 312-313

---

Récapitulatif des événements standard 312-313

Récapitulatif du fonctionnement standard 312-313

Récapitulatif général 313

Récapitulatif principal 312

REFerence 354, 443

référence de base de temps externe 163

Registre d'octet d'état 310

Registre de fonctionnement standard 310, 312-313

Registre de l'octet d'état 312-313

Registre des données suspectes 310  
requêtes 384

Registre des événements standard 310

registres 314

réglage 485, 495, 497-498, 500-502, 504, 506-507, 509-510, 513-514, 519, 528, 532, 536, 541-544, 546, 548, 551, 553, 555-556, 558, 561, 563

---

Réglage de l'amplitude de sortie 35

Réglage de la fréquence de sortie 34, 106, 114, 122, 131, 142, 148, 154, 485, 491, 519, 524

Réglage de la tension CC résiduelle 37

Réglage de la tension continue (CC) 39

Réglage du rapport cyclique d'un signal carré 40

Réglage du signal bas 38

Réglage du signal haut 38

réglages de la voie 2 491, 524

Régler la fréquence de sortie 94

Réinitialisation de la configuration d'usine 461

Réinitialisation usine 468

réinitialiser 47, 461

réinitialiser l'instrument 47

RELease 401

remplacement de la batterie 603

réparation 482

<b>R</b>		
	REQuest 312, 402	
<b>R</b>		
	Requête	
	Registre de l'octet d'état 313	
<b>R</b>		
	Requêtes 198	
	Paramètres 198	
<b>R</b>		
	RESet 322	
<b>R</b>		
	RESolved 321	
<b>R</b>		
	REStArt 322	
<b>R</b>		
	ROSCillator 374-375	
<b>R</b>		
	RST 199, 312, 327	
<b>R</b>		
	RTIME 392	
<b>S</b>		
	saisie d'un nombre 28	
	saisie de nombres 28	
	SAV 311	
	Schéma du système d'état 378	
	schéma fonctionnel 566, 568	
	SCPI 196	
	aide-mémoire 443	
	commandes par sous-système 6, 202	
	SDUMp 304	
	SECure 238-239	
	sécurité 488, 522	
	SECurity 404	
	Sélection d'un signal arbitraire prédéfini 42	
	Séparateurs de commandes 197	
	SEQuence 250, 337	
	Service 312	
	SETup 239	
	signal sinusoïdal 437	
	signal arbitraire 42, 67, 441	
	Signal bas 38	
	signal carré 438	
	signal en rafale 55	
	Signal FSK 49	
	Signal haut 38	
	Signal IQ 145	
	signal modulé 48	
	signal PWM 51	
	SINusoid 222	
	sinusoïdal 437	
	SKEW 302-303	
	SLOPe 351, 420	
	SMASk 411	
	SNAME 321	
	SOURce 208, 226, 262, 273, 349, 351, 359, 367, 374-375, 390, 421	
	Sous-système AM 204	
	Sous-système APPLy 212	
	Sous-système BPSK 224	
	Sous-système BURSt 230	
	Sous-système CALi-bration 236	
	Sous-système DATA 243	
	Sous-système DISPlay 252	
	Sous-système FM 257	
	Sous-système FREQuency 266	
	Sous-système FSKey 271	
	Sous-système FUNCTion 277	

Sous-système HCOPY 303	335, 340, 355, 362, 370-371, 390, 393, 395, 434	527
Sous-système LIST 318		TEXT 198, 254, 256
Sous-système LXI 319	STATus 381-384	TIME 303, 393, 404
Sous-système MARKer 322	STB? 313	TIMer 422
Sous-système MEMory 324	STOP 271	TRACk 416
Sous-système MMEMory 328	STORe 240, 339-341	TRAIling 294
Sous-système OUTPut 342	STRing 240	train d'impulsions 94
Sous-système PHASe 351	SUM 119, 387-390	Train d'impulsions 41
Sous-système PM 355	Support 6	TRANSition 290, 294
Sous-système PWM 363	Support technique 6	TRG 313
Sous-système RATE 371	SWEep 256, 392-393	TRIangle 221
Sous-système ROSCilla- tor 373	Symboles de sécurité 3	TRIGger 350-351, 418- 422
Sous-système SOURce 376	Symboles, sécurité 3	TST? 314
SPACing 392	SYMMetry 296	Types de paramètres SCPI 199
SPAN 271	SYNC 346-349	
SQUare 223, 297-298	SYNChronize 286, 355	<b>U</b>
SRATe 285, 373	SYSTem 394-402, 404- 414	UNIT 255-256, 424, 426, 437
SRE 312	Système d'aide 43	UNLock 355
START 271	Système d'état SCPI 468	UPDate 413
STATe 211, 229, 236, 239, 265, 268, 276, 302, 320, 322, 325-327,	<b>T</b>	UPLoad 342
	TELNet 412	Utilisation du message Device Clear 200
	temps de front 290, 294	
	Tension CC résiduelle 37, 494, 527	<b>V</b>
	Tension continue (CC) 39	Valeur basse 38
	tension résiduelle 494,	Valeur haute 38
		VALid 327

---

VALue 241

vérification 491-494,  
509, 524, 526-  
527, 554

vérification du fonc-  
tionnement 491,  
524

VERSion 404

VIEW 257

voies de sortie 79

VOLatile 252

VOLTage 428, 430-431,  
433-437

vue d'affichage 257

vue DUAL 257

vue GRAPh 257

vue STANdard 257

vue TEXT 257

## W

WAI 314

Wait-for-trigger 421

WIDTh 295

WINS 414

WMESsage 412



Ces informations peuvent faire l'objet  
de modifications sans préavis.

© Keysight Technologies, Inc. 2013 - 2020  
Édition 3, novembre 2020

Imprimé en Malaisie



33500-90912

[www.keysight.com](http://www.keysight.com)