

PWR Power Measurement Application

User's Guide

Notices

© Keysight Technologies, Inc. 2007-2016

No part of this manual may be reproduced in any form or by any means (including electronic storage and retrieval or translation into a foreign language) without prior agreement and written consent from Keysight Technologies, Inc. as governed by United States and international copyright laws.

Revision

Version 04.08.0000

Edition

July 15, 2016

Available in electronic format only

Published by:

Keysight Technologies, Inc.
1900 Garden of the Gods Road
Colorado Springs, CO 80907 USA

Warranty

The material contained in this document is provided "as is," and is subject to being changed, without notice, in future editions. Further, to the maximum extent permitted by applicable law, Keysight disclaims all warranties, either express or implied, with regard to this manual and any information contained herein, including but not limited to the implied warranties of merchantability and fitness for a particular purpose. Keysight shall not be liable for errors or for incidental or consequential damages in connection with the furnishing, use, or performance of this document or of any information contained herein. Should Keysight and the user have a separate written agreement with warranty terms covering the material in this document that conflict with these terms, the warranty terms in the separate agreement shall control.

Technology License

The hardware and/or software described in this document are furnished under a license and may be used or copied only in accordance with the terms of such license.

U.S. Government Rights

The Software is "commercial computer software," as defined by Federal Acquisition Regulation ("FAR") 2.101. Pursuant to FAR 12.212 and 27.405-3 and Department of Defense FAR Supplement ("DFARS") 227.7202, the U.S. government acquires commercial computer software under the same terms by which the software is customarily provided to the public. Accordingly, Keysight provides the Software to U.S. government customers under its standard commercial license, which is embodied in its End User License Agreement (EULA), a copy of which can be found at www.keysight.com/find/sweula. The license set forth in the EULA represents the exclusive authority by which the U.S. government may use, modify, distribute, or disclose the Software. The EULA and the license set forth therein, does not require or permit, among other things, that Keysight: (1) Furnish technical information related to commercial computer software or commercial computer software documentation that is not customarily provided to the public; or (2) Relinquish to, or otherwise provide, the government rights in excess of these rights customarily provided to the public to use, modify, reproduce, release, perform, display, or disclose commercial computer software or commercial computer software documentation. No additional government requirements beyond those set forth in the EULA shall apply, except to the extent that those terms, rights, or licenses are explicitly required from all providers of commercial computer software pursuant to the FAR and the DFARS and are set forth specifically in writing elsewhere in the EULA. Keysight shall be under no obligation to update, revise or

otherwise modify the Software. With respect to any technical data as defined by FAR 2.101, pursuant to FAR 12.211 and 27.404.2 and DFARS 227.7102, the U.S. government acquires no greater than Limited Rights as defined in FAR 27.401 or DFAR 227.7103-5 (c), as applicable in any technical data.

Safety Notices

CAUTION

A **CAUTION** notice denotes a hazard. It calls attention to an operating procedure, practice, or the like that, if not correctly performed or adhered to, could result in damage to the product or loss of important data. Do not proceed beyond a **CAUTION** notice until the indicated conditions are fully understood and met.

WARNING

A **WARNING** notice denotes a hazard. It calls attention to an operating procedure, practice, or the like that, if not correctly performed or adhered to, could result in personal injury or death. Do not proceed beyond a **WARNING** notice until the indicated conditions are fully understood and met.

Power Measurement Application—At a Glance

The DSOX3PWR/DSOX4PWR/DSOX6PWR Power Measurement and Analysis for the InfiniiVision 3000T/4000/6000 X-Series oscilloscopes lets you quickly and easily analyze switching power supply efficiency and reliability.

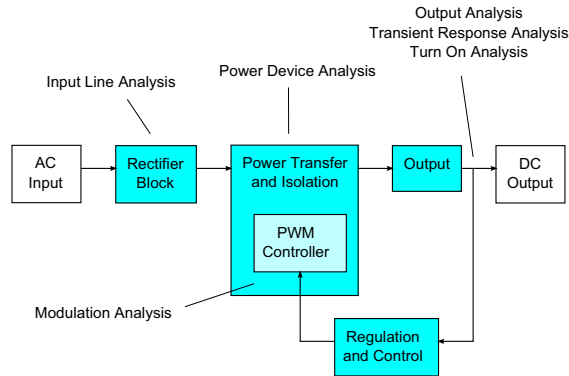

Figure 1 Switch-Mode Power Supply (SMPS) Block Diagram and Types of Measurements

With the Power Measurement Application, you can:

- Measure switching loss and conduction loss at the switching device (to help improve efficiency).
- Analyze di/dt and dV/dt slew rate (for reliable operation).
- Automate oscilloscope setup for ripple measurements (to eliminate tedious manual oscilloscope set up).
- Perform pre-compliance testing to IEC 61000-3-2 standards (to reduce compliance testing time).
- Analyze line power with total harmonic distortion, true power, apparent power, power factor, and crest factor tests (to quickly provide power quality information).
- Measure output noise (ripple).
- Analyze modulation using the on-time and off-time information of a Pulse Width Modulation (PWM) signal (to help characterize the active power factor).

- Measure how well a circuit rejects ripple coming from the input power supply at various frequencies with the Power Supply Rejection Ratio (PSRR) measurement.

The power measurement and analysis license, along with the oscilloscope, high-voltage differential probe, current probe, probe deskew fixture, and passive probe, form a complete power measurement system for power supply design and testing.

Included with DSOX3PWR/DSOX4PWR/DSOX6PWR, at no additional charge, is a license for the U1881A PC-based power analysis software package which provides additional offline power measurements and report generation.

This guide describes:

- **Chapter 1**, “Prerequisites,” starting on page 9
- **Chapter 2**, “Getting Started,” starting on page 15
- **Chapter 3**, “Performing Power Analysis,” starting on page 27
- **Chapter 4**, “Automatic Power Measurements,” starting on page 77

Contents

Power Measurement Application—At a Glance / 3

1 Prerequisites

Safety / 10

Oscilloscope Requirements / 11

Bandwidth Requirements / 11

Memory Requirements / 11

Software Version Requirements / 12

Probe Requirements / 13

Voltage Probe / 13

Current Probe / 13

De-Skewing the Voltage and Current Probes / 14

2 Getting Started

Step 1: Access the Power Measurement Application / 16

Step 2: Perform channel deskew / 17

Step 3: Select the type of power analysis / 20

Step 4: Make DUT connections and set up signals / 21

Step 5: Change the analysis settings (if available) / 23

Step 6: Apply the analysis / 24

Step 7: View the analysis results / 25

3 Performing Power Analysis

Input Measurements / 28

Power Quality / 28

Current Harmonics /	31
Inrush Current /	36
Switching Measurements /	39
Rds(on) and Vce(sat) /	39
Switching Loss /	42
Slew Rate /	46
Modulation /	49
Output Measurements /	53
Output Ripple /	53
Turn On/Turn Off /	55
Transient Response /	58
Efficiency /	61
Frequency Response Measurements /	65
Power Supply Rejection Ratio (PSRR) /	65
Control Loop Response (Bode) /	71

4 Automatic Power Measurements

Power Factor /	78
Real Power /	79
Apparent Power /	80
Reactive Power /	81
Crest Factor /	82
Phase Angle /	83
Output Ripple /	84
Input Power /	85
Output Power /	86
Efficiency /	87
Peak Current /	88

Transient /	89
Turn On Time /	90
Turn Off Time /	91
Rds(on) /	92
Vce(sat) /	93
Power Loss /	94
Power Loss/Cyc /	95
Energy Loss /	96

Index

1 Prerequisites

Safety / 10

Oscilloscope Requirements / 11

Probe Requirements / 13

This chapter describes safety considerations and the necessary requirements for using the Power Measurement Application.

Safety

WARNING

When connecting to a circuit with hazardous voltages, make sure the probes and other components are used within their ratings. Refer to the probes' and other components' documentation.

Oscilloscope Requirements

The DSOX3PWR/DSOX4PWR/DSOX6PWR Power Measurement Application works with the 3000T/4000/6000 X-Series digital storage oscilloscopes (DSO).

Characteristics of the power supply under test determine the oscilloscope bandwidth and memory required.

- **"Bandwidth Requirements"** on page 11
- **"Memory Requirements"** on page 11
- **"Software Version Requirements"** on page 12

Bandwidth Requirements

The bandwidth requirements of the oscilloscope and probe are driven by the slew rate (rise/fall times) of the switching device.

For oscilloscopes with Gaussian response (typical for 1 GHz and lower bandwidth oscilloscopes), the oscilloscope's rise time is commonly related to the oscilloscope's bandwidth using the formula:

$$\text{rise time} = 0.35/\text{bandwidth}$$

To measure an input signal's rise time with $\pm 5\%$ error, the oscilloscope's rise time must be 1/3 of the input signal's rise time. Therefore, the oscilloscope bandwidth required is:

$$\text{BW} = [0.35 / (\text{input signal rise time} / 3)]$$

For example, a switching device whose rise time is 10 ns requires oscilloscope (and probe) bandwidth of 105 MHz.

Memory Requirements

The memory requirements of the oscilloscope depend on the time range and the types of signals to capture:

$$\text{memory depth} = \text{time range} * \text{sample rate}$$

- For switching device signals: If you need to capture the switching signals for the duration of half the mains cycle (60 Hz), with a slew rate of 50 ns (using a sampling rate that is four times the required bandwidth), memory depth = $8.333 \text{ ms} * 21 \text{ MHz} * 4 = 699972$ points.

With InfiniiVision 3000 X-Series oscilloscopes, the sampling rate is determined by time range setting. In the above case, the sample rate in High Resolution mode for the time range of 8.333 ms is 100 MSa/s; therefore, the memory depth needed is 833300 points.

- For input AC line signals: You need to capture a few cycles in order to plot the FFT. Resolution of the FFT plot = sampling rate / data size. The expected harmonics are in multiples of 50/60 Hz.

Because the input signals have low frequency components, a high sampling rate is unnecessary. For example, the RTCA-DO-160E specification states that a sampling rate of 100 kSa/s and higher should be sufficient. For a 60 Hz signal, to capture 10 cycles you need to capture a duration of 83.33 ms.

The InfiniiVision 3000 X-Series oscilloscopes set the sampling rate to be 10 MSa/s for the above time range. The memory depth required is 83330 points with an FFT resolution of 4.77 Hz.

Software Version Requirements

Table 1 Oscilloscope Software Version Required

Oscilloscope Family	Software Version Required
InfiniiVision 3000T X-Series	4.00 or later
InfiniiVision 4000 X-Series	3.00 or later
InfiniiVision 6000 X-Series	6.00 or later

Probe Requirements

- **"Voltage Probe"** on page 13
- **"Current Probe"** on page 13
- **"De-Skewing the Voltage and Current Probes"** on page 14

Voltage Probe

You can use the following voltage probes:

- Keysight N2791A differential probe, 25 MHz, 700 V dynamic range.
- Keysight N2790A differential probe with AutoProbe interface, 100 MHz, 1.4 kV dynamic range.
- Keysight N2792A differential probe, 200 MHz bandwidth, 20 V dynamic range.
- Keysight N2793A differential probe, 800 MHz bandwidth, 15 V dynamic range.
- Keysight N2891A high-voltage differential probe, 70 MHz bandwidth, 7 kV dynamic range.
- Keysight 1141A differential probe, 200 MHz bandwidth, 400 V dynamic range.
- Keysight 10070D passive probe 1:1, 20 MHz bandwidth, 400 V max. input (for power supply noise measurement and for Power Supply Rejection Ratio measurement).
- Keysight N2870A passive probe, 1:1, 35 MHz bandwidth, 55 V max input (for power supply noise measurement and for Power Supply Rejection Ratio measurement).

For voltage probe bandwidth requirements, see **"Bandwidth Requirements"** on page 11.

The probe's voltage range required depends on the input signals to measure. An AC-DC switch mode power supply needs a high voltage range probe because the switching signals and input line signals can go up to 700 Vpp. For a DC-DC switch mode power supply, a smaller probe voltage range is sufficient because the signal amplitudes are much smaller.

A passive probe is typically used to measure DC output and transient response.

Current Probe

You can use the following Keysight AC/DC current probes:

- 1147B 50 MHz bandwidth, 15A peak.
- N2893A 100 MHz bandwidth, 30A peak.
- N2780A 2 MHz bandwidth, 500A peak.
- N2781A 10 MHz bandwidth, 150A peak.
- N2782A 50 MHz bandwidth, 30A peak.
- N2783A 100 MHz bandwidth, 30A peak.

For current probe bandwidth requirements, see **“Bandwidth Requirements”** on page 11.

De-Skewing the Voltage and Current Probes

To ensure accurate power loss measurements, use the U1880A deskew fixture to adjust the skew for any time delay differences between the current probe and voltage probe signal paths.

The procedure on de-skewing probes is described in **Chapter 2**, “Getting Started,” starting on page 15.

Table 2 U1880A Deskew Fixture Environmental Characteristics

Temperature	Operating: -10 °C to +55 °C Non-operating: -20 °C to +60 °C
Humidity	Operating: 95% RH at 40 °C for 24 hr Non-operating: 90% RH at 65 °C for 24 hr
Altitude	Operating: to 4,570 m (15,000 ft) Non-operating: to 15,244 m (50,000 ft)
Indoor use	Rated for indoor use only

2 Getting Started

Step 1: Access the Power Measurement Application / 16

Step 2: Perform channel deskew / 17

Step 3: Select the type of power analysis / 20

Step 4: Make DUT connections and set up signals / 21

Step 5: Change the analysis settings (if available) / 23

Step 6: Apply the analysis / 24

Step 7: View the analysis results / 25

This chapter gives an overview of the steps you must take when first performing power measurements.

Step 1: Access the Power Measurement Application

To access the power measurements application on the oscilloscope:

- 1 Press the **[Analyze]** key.
- 2 Press **Features**; then, select **Power Application**.
- 3 Press **Features** again to enable power measurements.

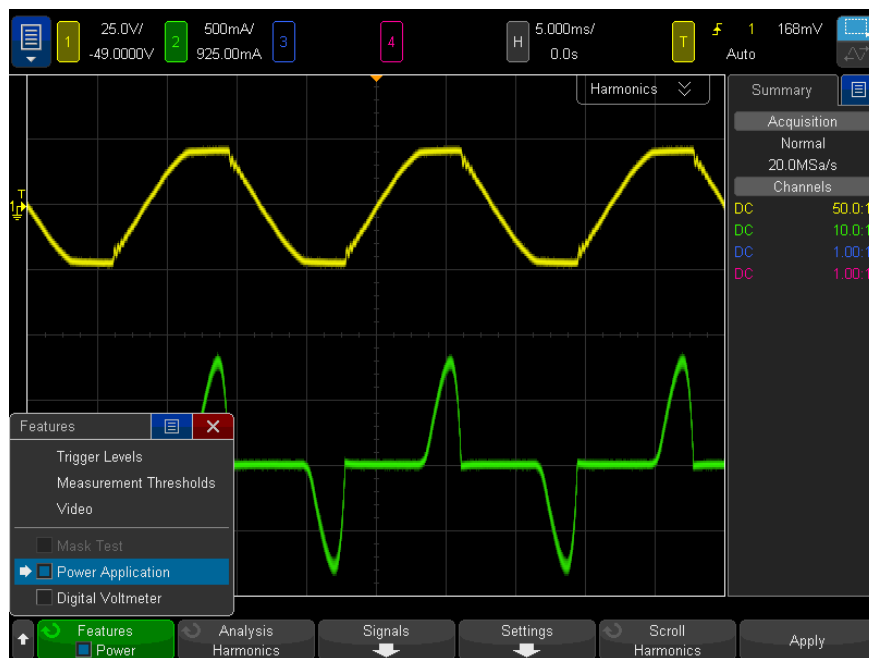

Next · **“Step 2: Perform channel deskew”** on page 17

Step 2: Perform channel deskew

To make accurate power loss measurements, you must perform current and voltage channel deskew using the U1880A deskew fixture. The channel deskew procedure calibrates the time delay between current and voltage probes.

You need to perform the deskew procedure once initially, and you should re-run the procedure when any part of the hardware setup changes (for example, a different probe, different oscilloscope channel, etc.) or when the ambient temperature changes.

To perform the channel deskew:

- 1 First, demagnetize and zero-adjust the current probe. Refer to the current probe's documentation for instructions on how to do this.
- 2 Make connections to the U1880A deskew fixture:

	Small Loop	Large Loop
For current probes:	<ul style="list-style-type: none"> ▪ 1147B (50 MHz, 15A) ▪ N2893A (10 MHz, 15A) ▪ N2782A (50 MHz, 30A) ▪ N2783A (100 MHz, 30A) 	<ul style="list-style-type: none"> ▪ N2780A (2 MHz, 500A) ▪ N2781A (10 MHz, 150A)
Connect high-voltage differential probe to either:	<ul style="list-style-type: none"> ▪ J5 (2.54 mm connector) ▪ J6 and J7 (alligator type) 	<ul style="list-style-type: none"> ▪ J2 (2.54 mm connector) ▪ J3 and J4 (alligator type)

- a Connect D+ and D- of the high-voltage differential probe to the deskew fixture.
- b Connect the current probe to the current loop with the direction of the arrow pointing towards the current flow.

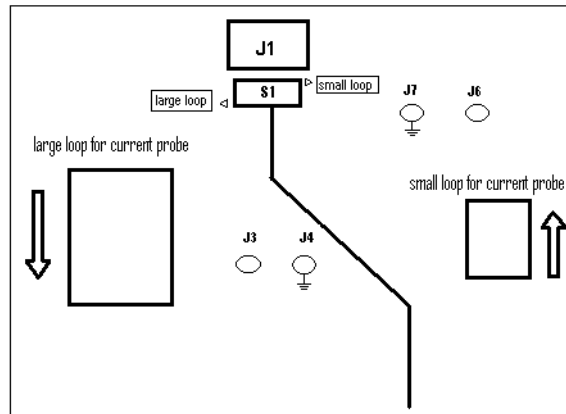

- c Make sure the switch on the deskew fixture is set to the appropriate side of the fixture (either "small loop" or "large loop").
 - d Connect the deskew fixture to a USB port on your oscilloscope or a PC using a USB cable. The USB port supplies power to the deskew fixture.
- 3** In the Power Application main menu, press the **Analysis** softkey and turn the Entry knob to select **Auto Deskew**.



- 4** Press the **Voltage** softkey and use the Entry knob to select the analog channel probing the voltage signal.
- 5** Press the **Current** softkey and use the Entry knob to select the analog channel probing the current signal.
- 6** Press the **Auto Deskew** softkey.

NOTE

Use the lowest attenuation setting on the high voltage differential probes whenever possible because the voltage levels on the deskew fixture are very small. Using a higher attenuation setting may yield inaccurate skew values (and affect the measurements made) because the noise level is magnified as well.

When the deskew process completes, you see a message indicating whether the deskew was successful, and if so, the settings being used.

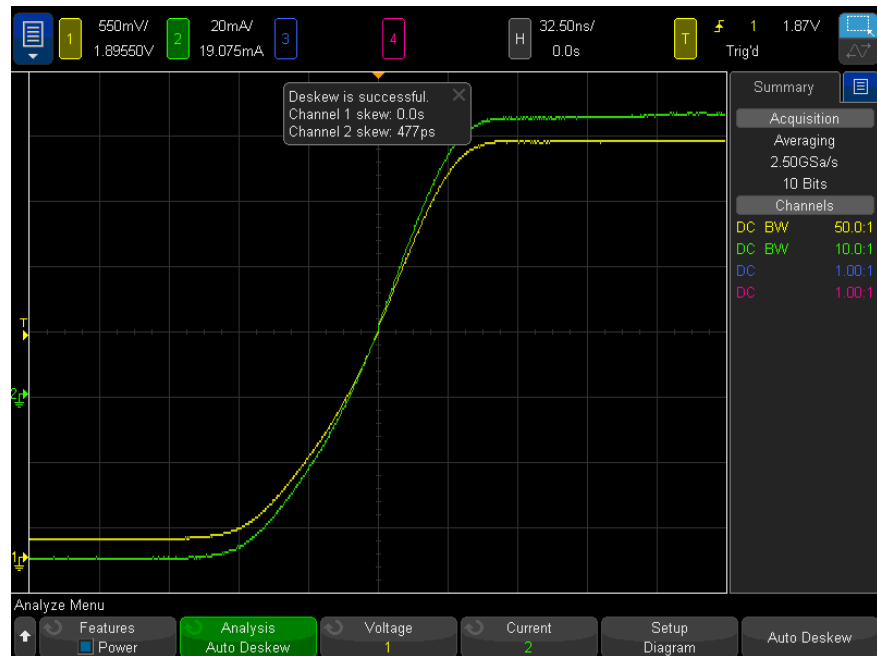

The deskew values are saved in the oscilloscope until a factory default or secure erase is performed. The next time you run the Power Application, you can use the saved deskew values or perform the deskew again.

Generally, you need to perform the deskew again when part of the test setup changes (for example, a different probe, different oscilloscope channel, etc.) or when the ambient temperature has changed.

- See Also**
- [U1880A Deskew Fixture User's Guide](#).
- Next**
- **"Step 3: Select the type of power analysis"** on page 20

Step 3: Select the type of power analysis

- 1 In the Power Application main menu, press the **Analysis** softkey; then, turn the Entry knob to select the type of power analysis.

The following types of power analysis are available:

- Power Quality
- Current Harmonics
- Inrush Current
- Rds(on) & Vce(sat)
- Switching Loss
- Slew Rate
- Modulation
- Output Ripple
- Turn On/Turn Off
- Transient Response
- Efficiency
- Power Supply Rejection Ratio (PSRR)
- Control Loop Response (Bode)

Next · **"Step 4: Make DUT connections and set up signals"** on page 21

Step 4: Make DUT connections and set up signals

For each type of power analysis, there is a **Signals** softkey and menu for specifying the oscilloscope channels being used and setting other related options.

- 1 In the Power Application main menu, press the **Signals** softkey.
- 2 In the Power Application Signals Menu, connect your probes to the device under test and to the oscilloscope as shown in the connection diagram.

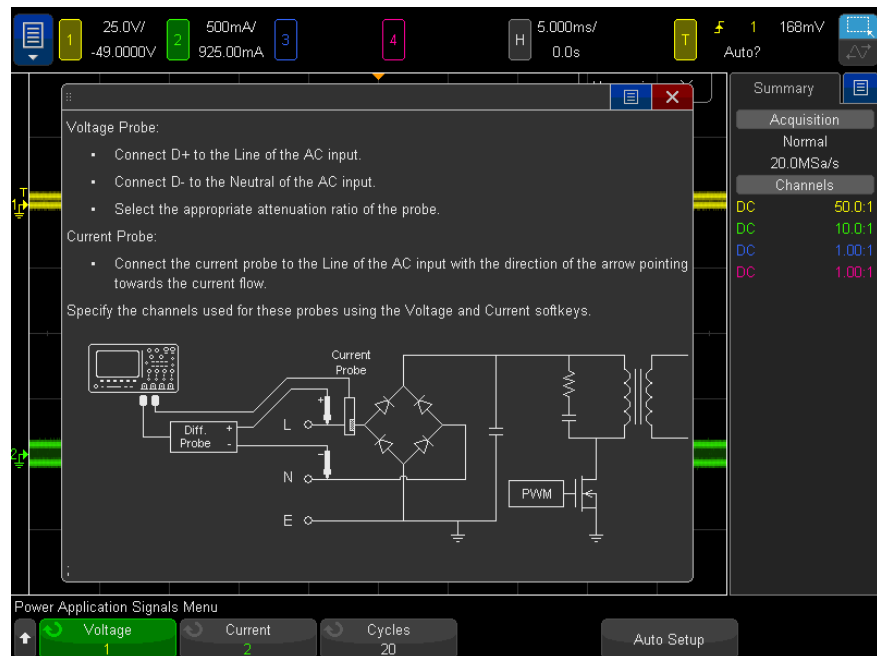

- 3 In the above example, you would press the **Voltage** and **Current** softkeys and make sure the proper analog channel is selected.

NOTE

Be sure to select the proper attenuation factor used for the voltage probe.

The attenuation factor multiplied by the probe's maximum output voltage gives the maximum input signal. For example, the N2791A probe's maximum output voltage is $\pm 7V$, so a 100:1 attenuation ratio gives a maximum input signal of $\pm 700V$.

NOTE

Also, be sure to select the proper attenuation factor used for the current probe.

- 4 If other softkeys are present for setting related options, like the **Cycles** softkey in the above example, use them to specify the appropriate settings.
- 5 If it is present, press the **Auto Setup** softkey to automatically scale and position the voltage and current channels and perhaps set the time/div.
- 6 Press the  Back/Up key to return to the Power Application main menu.

Next · **“Step 5: Change the analysis settings (if available)”** on page 23

Step 5: Change the analysis settings (if available)

If there are settings available for the type of power analysis chosen, there will be a **Settings** softkey or other softkeys in the Power Application main menu. To specify the power analysis settings:

- 1 In the Power Application main menu, press the **Settings** softkey or other softkeys to make the appropriate settings for the type of analysis being performed.

For example, the Current Harmonics settings menu looks like:

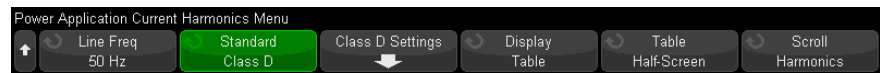

For descriptions of the settings available for each type of power analysis, see **Chapter 3**, “Performing Power Analysis,” starting on page 27.

- 2 When you have finished changing the settings, return to the Power Application main menu (perhaps by pressing the  Back/Up key if necessary).

Next · **“Step 6: Apply the analysis”** on page 24

Step 6: Apply the analysis

Each type of power analysis provides an **Apply** softkey for starting the analysis.

1 In the Power Application main menu, press **Apply**.

Next · **“Step 7: View the analysis results”** on page 25

Step 7: View the analysis results

Once a power analysis has completed, you can view the results in the following ways:

- By viewing the power analysis results on screen.
- By adding automatic power measurements.

Viewing Power Analysis Results on Screen

Power analysis results are displayed on the oscilloscope screen.

For example, here is a Current Harmonics analysis result:

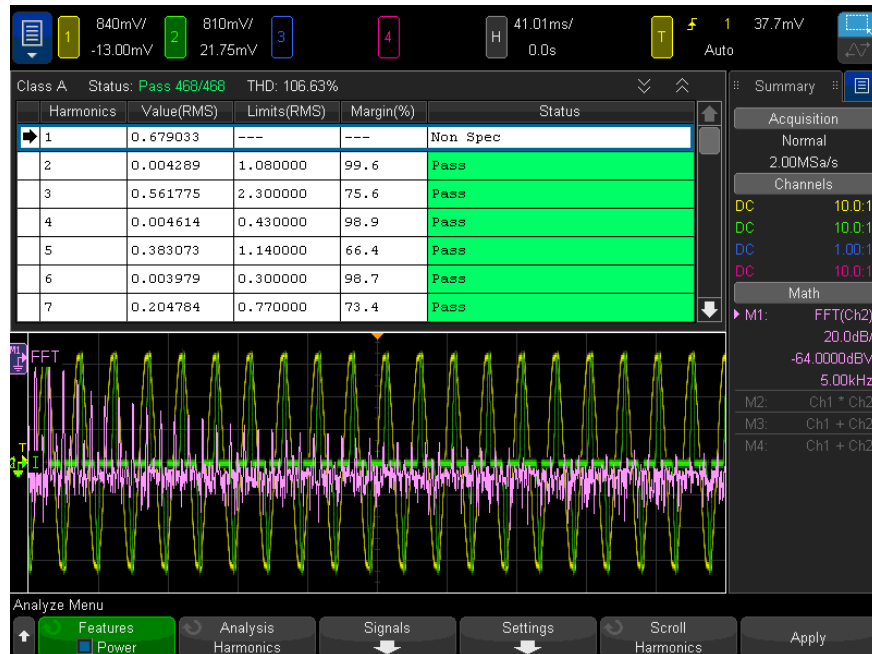

Adding Automatic Power Measurements

Just like adding automatic measurements of voltage (peak-to-peak, max, min, etc.) and time (frequency, period, rise time, fall time, etc.), you can also add automatic power measurements. See [Chapter 4](#), “Automatic Power Measurements,” starting on page 77.

See Also

To learn more about the individual types of power analysis, their input signals, their settings, and their results, see:

2 Getting Started

- **Chapter 3**, “Performing Power Analysis,” starting on page 27

3 Performing Power Analysis

Input Measurements / 28

Switching Measurements / 39

Output Measurements / 53

Frequency Response Measurements / 65

This chapter describes the types of power analysis you can perform with the Power Measurement Application, the proper probing connections to the device under test, signal setup, settings, and results.

Input Measurements

- **"Power Quality"** on page 28
- **"Current Harmonics"** on page 31
- **"Inrush Current"** on page 36

Power Quality

The Power Quality analysis shows the quality of the AC input line.

Some AC current may flow back into and back out of the load without delivering energy. This current, called reactive or harmonic current, gives rise to an "apparent" power which is larger than the actual power consumed. Power quality is gauged by these measurements: power factor, apparent power, true power, reactive power, crest factor, and phase angle of the current and voltage of the AC line.

- Signals Setup**
- 1** With the **Power Quality** analysis selected in the Power Application main menu, press the **Signals** softkey.
 - 2** Connect your probes to the device under test and to the oscilloscope as shown in the connection diagram.

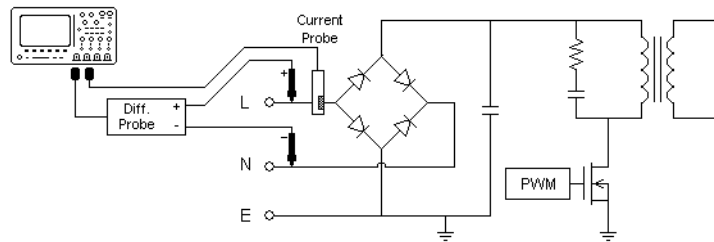



Figure 2 Typical Configuration for Input Line Analysis Tests

- a Connect D+ of the voltage probe to the live wire of the AC input.
 - b Connect D- of the voltage probe to the neutral wire of the AC input.
 - c On the voltage probe, select the appropriate attenuation ratio.
 - d Connect the current probe to the live wire of the AC input with the direction of the arrow pointing towards the current flow.
 - e Connect the voltage and current probes to the oscilloscope input channels.
- 3** Press the **Voltage** and **Current** softkeys and make sure the proper analog channel is selected.



- 4** Make sure the proper probe attenuation factors are set in the oscilloscope for the voltage and current probes.
- 5** Press the **Cycles** softkey; then, turn the Entry knob to select the desired number of cycles to capture in one acquisition.
- 6** Press the **Auto Setup** softkey to automatically set the vertical scale and position of the voltage and current channels.

Also displayed is the power waveform which is the math multiply operator of the voltage and current waveforms.

- 7** Press the  Back/Up key to return to the Power Application main menu.

Analysis Results To perform the analysis, press **Apply** in the Power Application main menu.

3 Performing Power Analysis

When the analysis has completed, results are displayed.



The voltage and current waveforms are displayed as well as the input power waveform (waveform math multiply of the voltage and current). Also displayed are the power quality measurements you have selected and applied:

- **Power Factor** – Ratio of the actual power to the apparent power. See **“Power Factor”** on page 78.
- **Real (Actual) Power** – The portion of power flow that, averaged over a complete cycle of the AC waveform, results in net transfer of energy in one direction. See **“Real Power”** on page 79.
- **Apparent Power** – The portion of power flow due to stored energy, which returns to the source in each cycle. See **“Apparent Power”** on page 80.
- **Reactive Power** – The difference between apparent power and real power due to reactance. See **“Reactive Power”** on page 81.

- **Crest Factor** – Crest factor is the ratio between the instantaneous peak current/voltage required by the load and the RMS current/voltage (RMS stands for Root Mean Square, which is a type of average). See “**Crest Factor**” on page 82.
- **Phase Angle** – In the *power triangle* (the right triangle where $\text{apparent_power}^2 = \text{real_power}^2 + \text{reactive_power}^2$), phase angle is the angle between the apparent power and the real power, indicating the amount of reactive power. See “**Phase Angle**” on page 83.
- DC RMS over one cycle. Refer to oscilloscope *User's Guide* for more information.
- Frequency. Refer to oscilloscope *User's Guide* for more information.

Power quality measurements are calculated using the captured voltage and current waveforms over the number of cycles specified.

Current Harmonics

Switching power supplies draw a range of harmonics from the AC mains.

Standard limits are set for these harmonics because these harmonics can travel back to the supply grid and cause problems with other devices on the grid.

Use the Current Harmonics analysis to test a switching power supply's current harmonics to pre-compliance standard of IEC61000-3-2 (Class A, B, C, or D). The analysis presents up to 40 harmonics.

Signals Setup

- 1 With the **Current Harmonics** analysis selected in the Power Application main menu, press the **Signals** softkey.
- 2 Connect your probes to the device under test and to the oscilloscope as shown in the connection diagram.

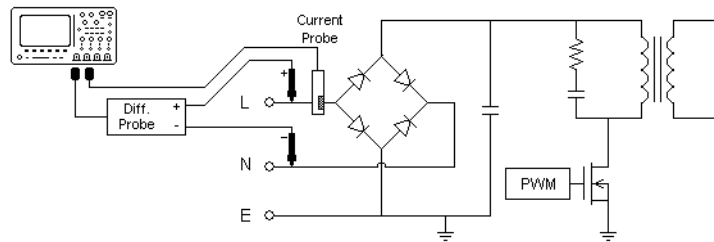



Figure 3 Typical Configuration for Input Line Analysis Tests

- a Connect D+ of the voltage probe to the live wire of the AC input.
 - b Connect D- of the voltage probe to the neutral wire of the AC input.
 - c On the voltage probe, select the appropriate attenuation ratio.
 - d Connect the current probe to the live wire of the AC input with the direction of the arrow pointing towards the current flow.
 - e Connect the voltage and current probes to the desired oscilloscope channels.
- 3** Press the **Voltage** and **Current** softkeys and make sure the proper analog channels are selected.



- 4** Make sure the proper probe attenuation factors are set in the oscilloscope for the voltage and current probes.
- 5** Press the **Cycles** softkey; then, turn the Entry knob to select the desired number of cycles to capture in one acquisition.
- 6** Press the **Auto Setup** softkey to automatically scale and position the voltage and current channels and set the appropriate time/div.

Also set automatically is the Hanning FFT window (for better frequency resolution and low spectral leakage). If you choose to set up signals manually, you can select other FFT windows for analysis, such as the Blackman-Harris window (for minimal spectral leakage) or the Hamming window (for better frequency resolution and moderate spectral leakage).

7 Press the  Back/Up key to return to the Power Application main menu.

Settings

- 1 In the Power Application main menu, press the **Settings** softkey.
- 2 In the Power Application Current Harmonics Menu, make the appropriate settings.



Table 3 Current Harmonics Analysis Settings

Setting	Description
Line Freq	Enter the line frequency.
Standard	Select the standard to perform compliance testing on the current harmonics. <ul style="list-style-type: none"> ▪ IEC 61000-3-2 Class A – for balanced three-phase equipment, household appliances (except equipment identified as Class D), tools excluding portable tools, dimmers for incandescent lamps, and audio equipment. ▪ IEC 61000-3-2 Class B – for portable tools. ▪ IEC 61000-3-2 Class C – for lighting equipment. Class C requires a power factor calculation that happens when the Apply softkey (in the Power Application main menu) is pressed. For this reason, you are only allowed to select Class C when the Power Application is disabled – it forces you to press Apply (again) to perform the analysis. ▪ IEC 61000-3-2 Class D – for equipment having a specified power according less than or equal to 600 W, of the following types: personal computers and personal computer monitors, television receivers.
Class D Settings	When the Class D standard is selected, press this softkey to open the Power Application Class D Settings Menu where you can specify whether the Real Power value used for the current-per-watt measurement is measured by the oscilloscope or is user-defined. When user-defined is selected, enter the value.
Display	Choose how to display harmonics: <ul style="list-style-type: none"> ▪ Table. ▪ Bar Chart. ▪ Off – Harmonics measurement results are not displayed.

3 Performing Power Analysis

After the analysis has been performed, you can return to the settings menu to:

- Change the display type.
- If results are displayed in Bar Chart or Table form, press the **Scroll Harmonics** softkey and use the Entry knob to scroll current harmonics analysis results.
- When the Class D standard is selected and results are displayed in Bar Chart form, press the **Display** softkey to choose whether results are displayed as RMS or current-per-watt (mA/W) values. (The table display option includes both RMS and mA/W values.)

- 3 When you have finished changing the settings, press the  Back/Up key to return to the Power Application main menu.

Analysis Results To perform the analysis, press **Apply** in the Power Application main menu.

When the analysis has completed, results are displayed.

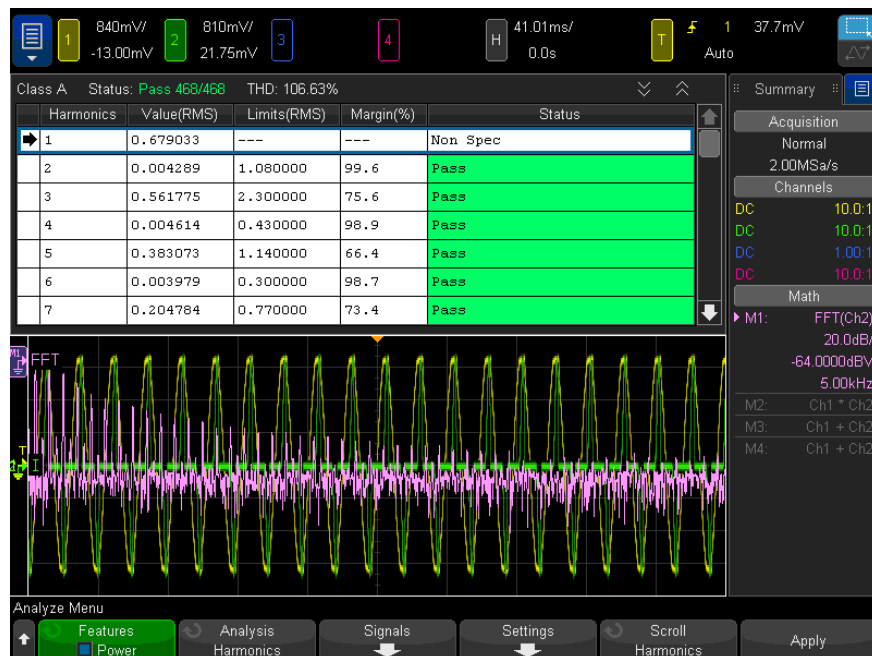

Table 4 Current Harmonics Test Results

FFT waveform	Shows the frequency components in the input current. The FFT is calculated using the Hanning window.
Harmonic, Actual Value (RMS), Limit (RMS), Margin, Pass/Fail Status	<p>For the first 40 harmonics, these values are displayed:</p> <ul style="list-style-type: none"> ▪ Actual Value (RMS) – the measured value in the units specified by the Harmonics Unit parameter. ▪ Limit (RMS) – the limit specified by the selected Current Harmonics Standard parameter. ▪ Margin – the margin specified by the selected Current Harmonics Standard parameter. ▪ Pass/Fail Status – whether the value passes or fails according to the selected Current Harmonics Standard. <p>Rows in the table or bars in the chart are color-coded according to pass/fail values. Marginal results are greater than 85% of the limit but less than 100% of the limit.</p>
THD (Total Harmonic Distortion)	$\text{THD} = 100 \times \frac{\sqrt{X_2^2 + X_3^2 + X_n^2 + \dots}}{X_1}$ <p>Where:</p> <ul style="list-style-type: none"> ▪ X_n = voltage or current of each harmonic ▪ X_1 = fundamental voltage or current value

Saving Harmonics Test Results

To save current harmonics test results to a USB storage device

- 1 Press the **[Save/Recall]** key.
- 2 In the Save/Recall Menu, press the **Save** softkey.
- 3 In the Save Menu, press the **Format** softkey and turn the Entry knob to select **Power Harmonics data (*.csv)**.
- 4 Press the softkey in the second position and use the Entry knob to navigate to the save location. See the oscilloscope *User's Guide* for information on navigating storage locations.
- 5 Finally, press the **Press to Save** softkey.

A message indicating whether the save was successful is displayed.

Automatic Measurements

You can add these relevant automatic measurements using the **[Meas]** key and menu.

Automatic Power App measurements:

- **“Apparent Power”** on page 80
- **“Crest Factor”** on page 82

Automatic Voltage measurements (refer to oscilloscope *User's Guide* for more information):

- AC - RMS

Inrush Current

The Inrush current analysis measures the peak inrush current of the power supply when the power supply is first turned on.

- Signals Setup**
- 1 With the **Inrush** analysis selected in the Power Application main menu, press the **Signals** softkey.
 - 2 Connect your probes to the device under test and to the oscilloscope as shown in the connection diagram.

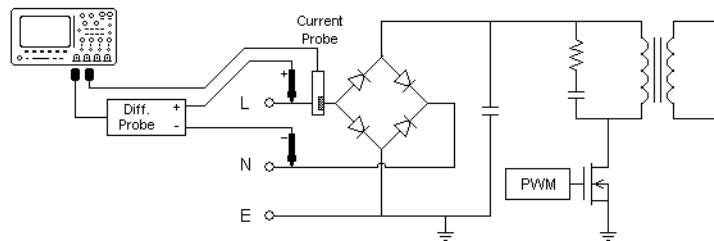



Figure 4 Typical Configuration for Inrush Current Analysis Tests

- a Connect D+ of the voltage probe to the live wire of the AC input.
- b Connect D- of the voltage probe to the neutral wire of the AC input.
- c On the voltage probe, select the appropriate attenuation ratio.
- d Connect the current probe to the live wire of the AC input with the direction of the arrow pointing towards the current flow.
- e Connect the voltage and current probes to the oscilloscope input channels.

- 3 Press the **Voltage** and **Current** softkeys and make sure the proper analog channels are selected.



- 4 Make sure the proper probe attenuation factors are set in the oscilloscope for the voltage and current probes.
- 5 Press the **Type** softkey; then, turn the Entry knob to select the type of power that is being converted from the input to the output. Your selection affects how the measurements are made.
- 6 Press the **Max Vin** softkey; then, turn the Entry knob to specify the maximum input voltage. This sets the vertical scale of the channel probing voltage.
- 7 Press the **Expected** softkey; then, turn the Entry knob to specify the expected inrush current amplitude. This sets the vertical scale of the channel probing current.
- 8 Press the  Back/Up key to return to the Power Application main menu.

Analysis Results To perform the analysis, press **Apply** in the Power Application main menu.

Follow the onscreen instructions. When the analysis has completed, results are displayed.

3 Performing Power Analysis

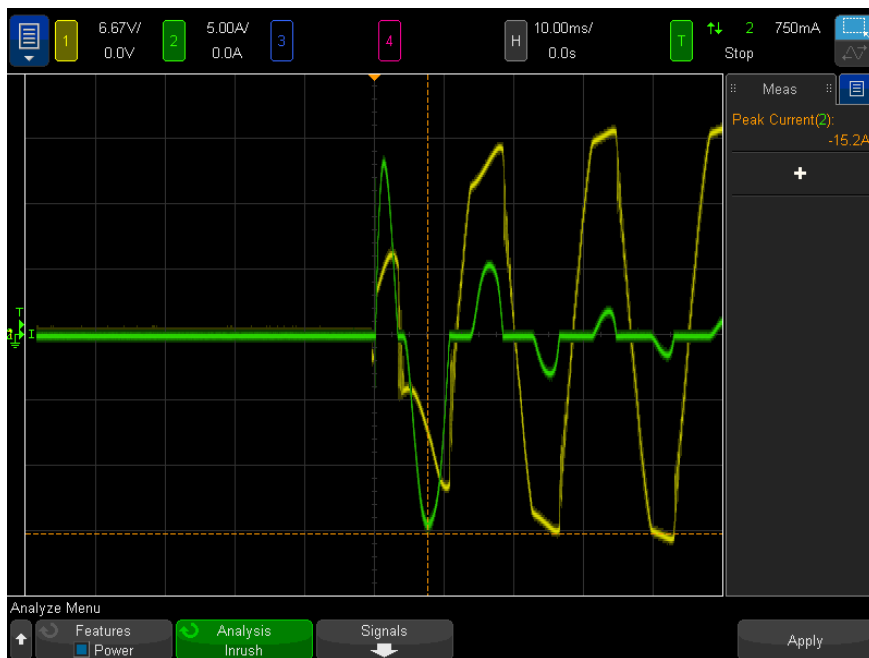

The voltage and current waveforms are displayed. Also displayed is this automatic power measurements:

- **“Peak Current”** on page 88

Switching Measurements

- “**Rds(on) and Vce(sat)**” on page 39
- “**Switching Loss**” on page 42
- “**Slew Rate**” on page 46
- “**Modulation**” on page 49

Rds(on) and Vce(sat)

The Rds(on) and Vce(sat) analysis measures these characteristics of a switching device. It indicates whether a switching device is operating near the values published in the device's data sheet.

- Signals Setup**
- 1 With the **Rds(on) & Vce(sat)** analysis selected in the Power Application main menu, press the **Signals** softkey.
 - 2 Connect your probes to the device under test and to the oscilloscope as shown in the connection diagram.

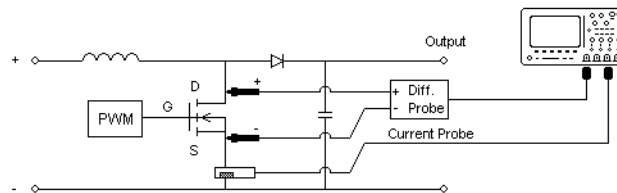

Figure 5 Typical Configuration for Power Device Analysis Tests

- a Connect D+ of the voltage probe to the source of the MOSFET.
- b Connect D- of the voltage probe to the drain of the MOSFET.
- c On the voltage probe, select the appropriate attenuation ratio.
- d Connect the current probe to the drain of the MOSFET with the direction of the arrow pointing towards the current flow.
- e Connect the voltage and current probes to the oscilloscope input channels.

- 3 Press the **Voltage** and **Current** softkeys and make sure the proper analog channel is selected.



- 4 Make sure the proper probe attenuation factors are set in the oscilloscope for the voltage and current probes.
- 5 Press the **Auto Setup** softkey to automatically set the vertical scale and position of the voltage and current channels.
- 6 If offset calibration is required, press the **Offset Calibration** softkey to be guided through a calibration procedure that measures the offset error of the voltage input channel and current input channel to correct for oscilloscope/probe offset error.

Although the oscilloscope's user calibration (**[Utility] > Service**) calibrates offsets for all input channels to within ± 0.1 division for all vertical scale settings, this relatively small amount of offset error can contribute significant switching loss measurement error, especially during the conduction phase, when voltage is near zero, and also during the non-conduction phase, when current is near zero. This is a classic oscilloscope dynamic range limitation when attempting to measure small voltages and/or currents in the presence of relatively large switching voltages and/or currents.

After performing the **Offset Calibration** procedure, precision calibration factors are applied when you press the **Apply** softkey to start the power analysis.

If you make any vertical scaling changes to the voltage and/or current waveforms, the calibration factors become invalid and a red message appears in the menu area indicating that a new **Offset Calibration** is required. Open the Signals Menu and select **Offset Calibration** to create new precision offset calibration factors for the current vertical scale settings.

- 7 Press the  Back/Up key to return to the Power Application main menu.

Analysis Results To perform the analysis, press **Apply** in the Power Application main menu.

When the analysis has completed, results are displayed.

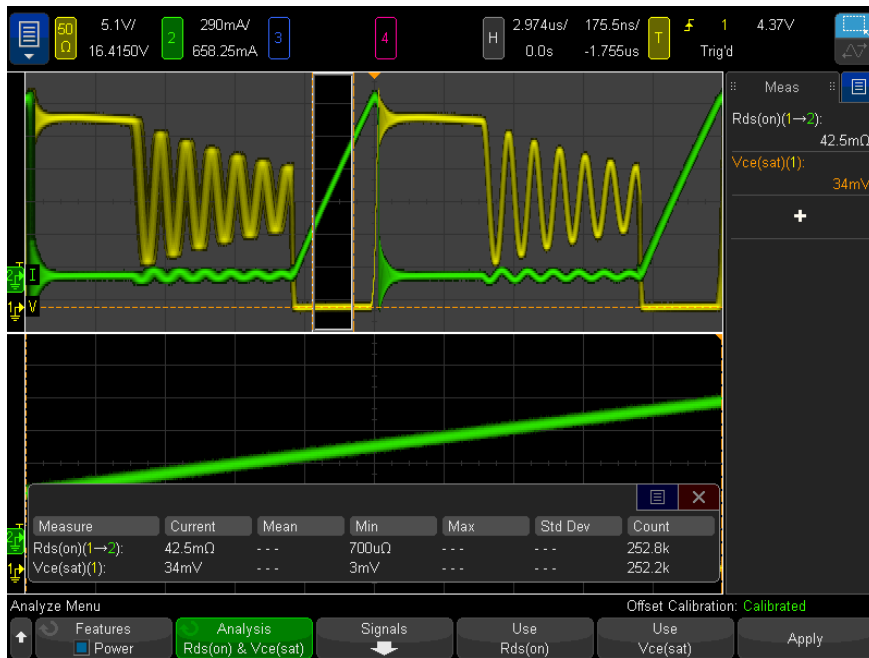

The voltage and current waveforms are displayed, as well as these automatic power measurements and statistics:

- "Rds(on)" on page 92
- "Vce(sat)" on page 93

Using Rds(on) and Vce(sat) Results in Switching Loss Analysis

You can use the results of the Rds(on) and Vce(sat) analysis in the Switching Loss power analysis:

- Press **Use Rds(on)** to start the Switching Loss analysis with its Rds(on) conduction calculation setting and the measured mean Rds(on) value.
- Press **Use Vce(sat)** to start the Switching Loss analysis with its Vce(sat) conduction calculation setting and the measured mean Vce(sat) value.

To get a more accurate Rds(on) and Vce(sat) measurements, use the acquisition Averaging mode when accumulating the measurement statistics.

Switching Loss

The Switching Loss analysis calculates the power dissipated in the switching cycles across the switching device. Typical power losses include:

- Switching losses that occur during switching of V_{ds} and I_d .
- Conduction losses that occur when the switching device (MOSFET) is ON.

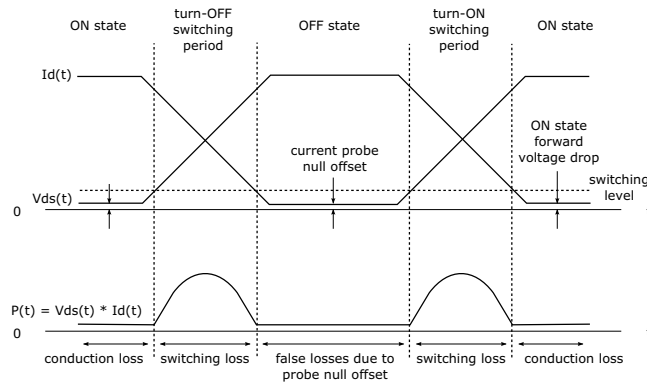

Figure 6 Loss Occurrence in the Power Device

Design engineers use this information to improve the power conversion efficiency of the power supply.

Switching loss is also used to quantify the power loss that is transferred to the heat sink of the power device.

Signals Setup

- 1 With the **Switching Loss** analysis selected in the Power Application main menu, press the **Signals** softkey.
- 2 Connect your probes to the device under test and to the oscilloscope as shown in the connection diagram.

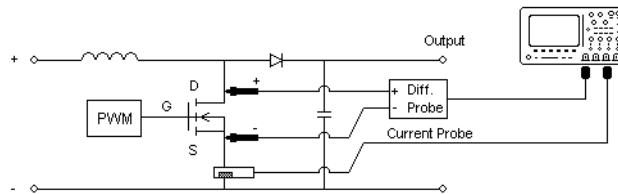

Figure 7 Typical Configuration for Power Device Analysis Tests

- a Connect D+ of the voltage probe to the source of the MOSFET.
 - b Connect D- of the voltage probe to the drain of the MOSFET.
 - c On the voltage probe, select the appropriate attenuation ratio.
 - d Connect the current probe to the drain of the MOSFET with the direction of the arrow pointing towards the current flow.
 - e Connect the voltage and current probes to the oscilloscope input channels.
- 3** Press the **Voltage** and **Current** softkeys and make sure the proper analog channel is selected.



- 4 Make sure the proper probe attenuation factors are set in the oscilloscope for the voltage and current probes.
- 5 Press the **Auto Setup** softkey to automatically set the vertical scale and position of the voltage and current channels.
- 6 If offset calibration is required, press the **Offset Calibration** softkey to be guided through a calibration procedure that measures the offset error of the voltage input channel and current input channel to correct for oscilloscope/probe offset error.

Although the oscilloscope's user calibration (**[Utility]** > **Service**) calibrates offsets for all input channels to within ± 0.1 division for all vertical scale settings, this relatively small amount of offset error can contribute significant switching loss measurement error, especially during the conduction phase, when voltage is near zero, and also during the non-conduction phase, when current is near

3 Performing Power Analysis

zero. This is a classic oscilloscope dynamic range limitation when attempting to measure small voltages and/or currents in the presence of relatively large switching voltages and/or currents.

After performing the **Offset Calibration** procedure, precision calibration factors are applied when you press the **Apply** softkey to start the power analysis.

If you make any vertical scaling changes to the voltage and/or current waveforms, the calibration factors become invalid and a red message appears in the menu area indicating that a new **Offset Calibration** is required. Open the Signals Menu and select **Offset Calibration** to create new precision offset calibration factors for the current vertical scale settings.

- 7 Press the  Back/Up key to return to the Power Application main menu.

Settings

- 1 In the Power Application main menu, press the **Settings** softkey.
- 2 In the Power Application Switching Loss Menu, make the appropriate settings.



Table 5 Switching Loss Analysis Settings

Setting	Description
V Ref	Enter the switching level for the switching edges. The value is in percentage of the maximum switch voltage. You can adjust this value to ignore noise floors. This value specifies the threshold that is used to determine the switching edges.
I Ref	Enter the switching level for the start of switching edges. The value is in percentage of the maximum switch current. You can adjust this value to ignore noise floors or null offset that is difficult to eliminate in current probes. This value specifies the threshold that is used to determine the switching edges.
Conduction	Choose how to calculate conduction: <ul style="list-style-type: none"> ▪ Voltage waveform – The Power waveform uses the original data, and the calculation is: $P = V \times I$ ▪ Rds(on) – The Power waveform includes error correction: <ul style="list-style-type: none"> ▪ In the On Zone (where the voltage level is below V Ref) – the Power calculation is: $P = I_d^2 \times R_{ds(on)}$ Specify Rds(on) using the additional softkey. ▪ In the Off Zone (where the current level is below I Ref) – the Power calculation is: $P = 0$ Watt. ▪ Vce(sat) – The Power waveform includes error correction: <ul style="list-style-type: none"> ▪ In the On Zone (where the voltage level is below V Ref) – the Power calculation is: $P = V_{ce(sat)} \times I_c$ Specify Vce(sat) using the additional softkey. ▪ In the Off Zone (where the current level is below I Ref) – the Power calculation is: $P = 0$ Watt.

- 3** When you have finished changing the settings, press the  Back/Up key to return to the Power Application main menu.

Analysis Results To perform the analysis, press **Apply** in the Power Application main menu.

When the analysis has completed, results are displayed.

3 Performing Power Analysis



The voltage and current waveforms are displayed, as well as the power waveform (waveform math multiply of the voltage and current). Also displayed are these automatic power measurements and statistics:

- **“Power Loss”** on page 94
- **“Power Loss/Cyc”** on page 95
- **“Energy Loss”** on page 96

Automatic Measurements

You can add these relevant automatic measurements using the **[Meas]** key and menu.

Automatic Time measurements (refer to oscilloscope *User's Guide* for more information):

- Frequency

Slew Rate

The Slew Rate analysis measures the rate of voltage or current change during switching.

- Signals Setup**
- 1 With the **Slew Rate** analysis selected in the Power Application main menu, press the **Signals** softkey.
 - 2 Connect your probes to the device under test and to the oscilloscope as shown in the connection diagram.

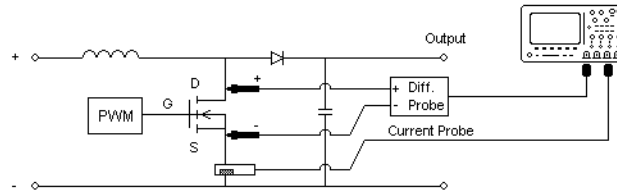



Figure 8 Typical Configuration for Power Device Analysis Tests

- a Connect D+ of the voltage probe to the source of the MOSFET.
 - b Connect D- of the voltage probe to the drain of the MOSFET.
 - c On the voltage probe, select the appropriate attenuation ratio.
 - d Connect the current probe to the drain of the MOSFET with the direction of the arrow pointing towards the current flow.
 - e Connect the voltage and current probes to the oscilloscope input channels.
- 3 Press the **Voltage** and **Current** softkeys and make sure the proper analog channel is selected.



- 4 Make sure the proper probe attenuation factors are set in the oscilloscope for the voltage and current probes.
- 5 Press the **Auto Setup** softkey to automatically set the vertical scale and position of the voltage and current channels.
- 6 Press the  Back/Up key to return to the Power Application main menu.

3 Performing Power Analysis

- Settings** 1 In the Power Application main menu, press the **Source** softkey; then, turn the Entry knob to select either **dV/dt** or **dI/dt** as the source for the slew rate analysis.



- Analysis Results** To perform the analysis, press **Apply** in the Power Application main menu. When the analysis has completed, results are displayed.



The voltage and current waveforms are displayed along with a differentiate math function waveform that shows the slew rate.

Max and Min measurements on the differentiate math function waveform are added and displayed.

Table 6 Slew Rate Test Results

dV/dt	$[y_{(n)} - y_{(n-1)}] / [x_{(n)} - x_{(n-1)}]$, measures the slew rate of Vds of the power device (MOSFET).
dI/dt	$[y_{(n)} - y_{(n-1)}] / [x_{(n)} - x_{(n-1)}]$, measures the slew rate of Id of the power device (MOSFET).

Modulation

The Modulation analysis measures the control pulse signal to a switching device (MOSFET) and observes the trending of the pulse width, duty cycle, period, frequency, etc. of the control pulse signal in response to different events.

- Signals Setup**
- 1 With the **Modulation** analysis selected in the Power Application main menu, press the **Signals** softkey.
 - 2 Connect your probes to the device under test and to the oscilloscope as shown in the connection diagram.

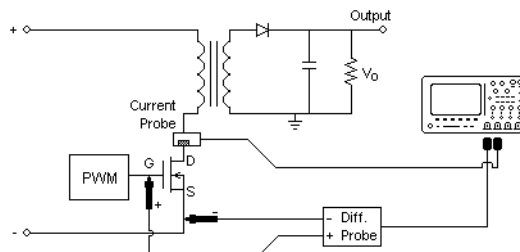
**Figure 9** Continuous Mode Connection for Modulation Analysis Tests

- a Connect D+ of the voltage probe to the gate of the MOSFET.
 - b Connect D- of the voltage probe to the source of the MOSFET.
 - c On the voltage probe, select the appropriate attenuation ratio.
 - d Connect the current probe to the drain of the MOSFET.
 - e Connect the voltage and current probes to oscilloscope input channels.
- 3 Press the **Voltage** and **Current** softkeys and make sure the proper analog channels are selected.

3 Performing Power Analysis



- 4 Make sure the proper probe attenuation factors are set in the oscilloscope for the voltage and current probes.
- 5 Press the **Duration** softkey; then, turn the Entry knob to specify the time to capture signals. This sets the time scale of the oscilloscope.
- 6 Press the **Auto Setup** softkey to automatically set the vertical scale and position of the voltage and current channels.
- 7 Adjust the trigger level to capture waveforms at the same place in each cycle (in other words, stabilize the waveform display).
- 8 Press the  Back/Up key to return to the Power Application main menu.

Settings

- 1 In the Power Application main menu, press the **Source** softkey; then, turn the Entry knob to select either Voltage or Current as the source for the modulation analysis.



- 2 Press the **Measurement** softkey; then, turn the Entry knob to select the type of measurement to make in the modulation analysis:
 - Average
 - RMS - AC
 - Ratio
 - Period
 - Frequency
 - +Width
 - -Width
 - +Duty Cycle
 - -Duty Cycle
 - Rise Time
 - Fall Time

Analysis Results To perform the analysis, press **Apply** in the Power Application main menu. When the analysis has completed, results are displayed.

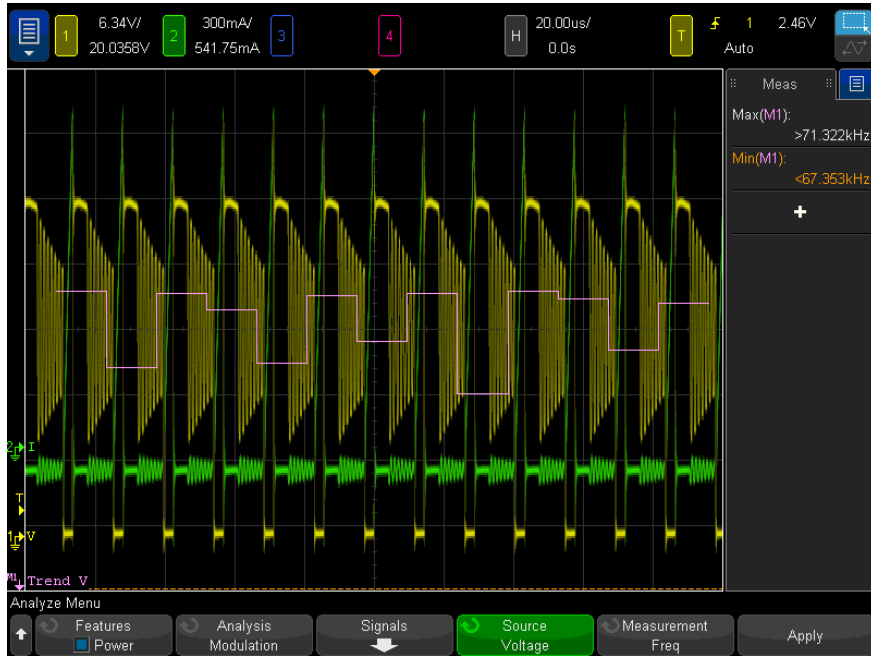

The Measurement Trend math waveform visualization is used to plot the measurement variation for each cycle of the modulation waveforms.

Automatic Measurements

You can add these relevant automatic measurements using the **[Meas]** key and menu.

Automatic Voltage measurements (refer to oscilloscope *User's Guide* for more information):

- Average
- AC - RMS
- Ratio

Automatic Time measurements (refer to oscilloscope *User's Guide* for more information):

- Period

3 Performing Power Analysis

- Frequency
- +Width
- -Width
- +Duty Cycle
- -Duty Cycle
- Rise Time
- Fall Time

Output Measurements

- “**Output Ripple**” on page 53
- “**Turn On/Turn Off**” on page 55
- “**Transient Response**” on page 58
- “**Efficiency**” on page 61

Output Ripple

The Output Ripple analysis measures the ripple noise of the power supply output.

- Signals Setup**
- 1 With the **Output Ripple** analysis selected in the Power Application main menu, press the **Signals** softkey.
 - 2 Connect your probes to the device under test and to the oscilloscope as shown in the connection diagram.

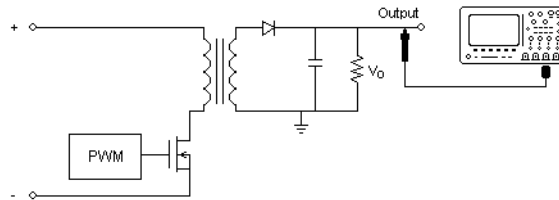



Figure 10 Typical Configuration for Output Voltage Ripple Test

- a Connect the voltage probe (passive or differential) to the DC output of the power supply.
 - b Connect the voltage probe to an oscilloscope input channel.
- 3 Press the **Voltage** softkey and make sure the proper analog channel is selected.



3 Performing Power Analysis

- 4 Make sure the proper probe attenuation factor is set in the oscilloscope for the voltage probe.
- 5 Press the **Duration** softkey; then, turn the Entry knob to select the time scale of the measurement.
- 6 Press the **Auto Setup** softkey to automatically set the vertical scale and position of the voltage channel as well as the time scale.
- 7 Press the  Back/Up key to return to the Power Application main menu.

Analysis Results To perform the analysis, press **Apply** in the Power Application main menu.

When the analysis has completed, results are displayed.

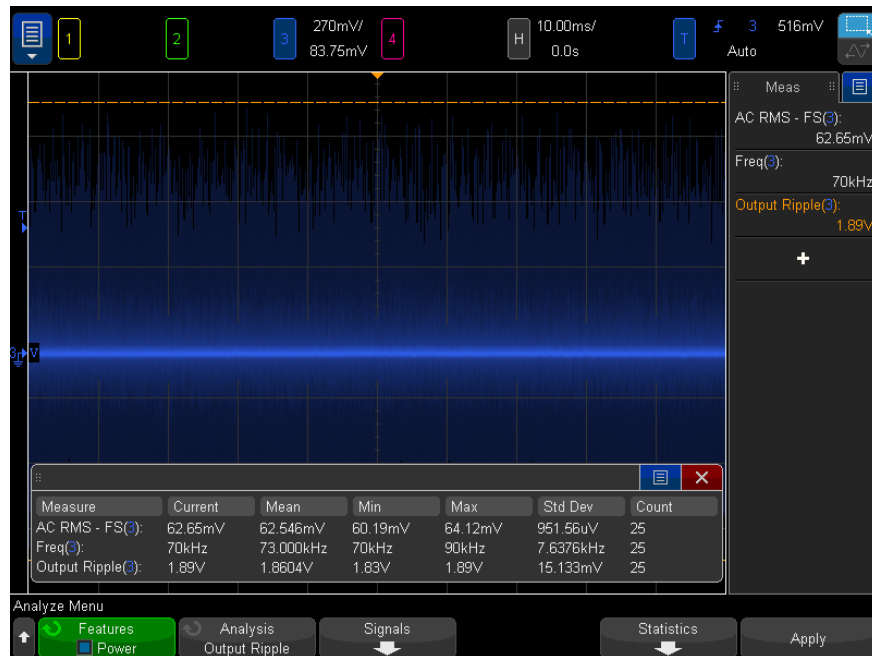

The output voltage waveforms is displayed along with this automatic power measurement:

- **“Output Ripple”** on page 84

Turn On/Turn Off

The Turn On analysis determines how fast a turned on power supply takes to reach 90% of its steady state output.

The Turn Off analysis determines how fast a turned off power supply takes to reduce its output voltage to 10% of maximum.

- Signals Setup**
- 1 With the **Turn On/Turn Off** analysis selected in the Power Application main menu, press the **Signals** softkey.
 - 2 Connect your probes to the device under test and to the oscilloscope as shown in the connection diagram.

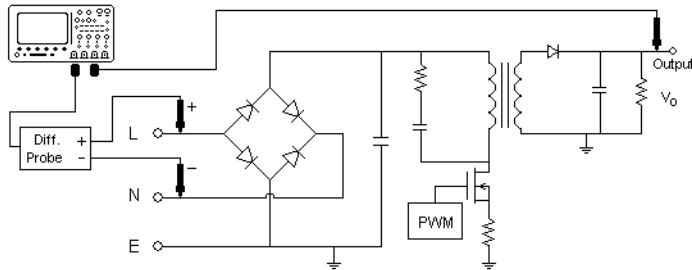



Figure 11 Typical Configuration for Turn On/Off Analysis Tests

- a Connect D+ of the input voltage probe to the live wire of the AC input.
 - b Connect D- of the input voltage probe to the neutral wire of the AC input.
 - c On the input voltage probe, select the appropriate attenuation ratio.
 - d Connect the output voltage probe (passive or differential) to the DC output of the power supply.
 - e Connect the voltage probes to the oscilloscope input channels.
- 3 Press the **Input V** and **Output V** softkeys and make sure the proper analog channels are selected.



4 Make sure the proper probe attenuation factors are set in the oscilloscope for the voltage probes.

5 Press the  Back/Up key to return to the Power Application main menu.

Settings 1 In the Power Application main menu, press the **Test** softkey; then, turn the Entry knob to select whether turn on or turn off analysis is performed:



- Turn On – determines how fast a turned on power supply takes to reach some percent of its steady state output. Turn on time is the time between T2 and T1 where:
 - T1 = when the input voltage first rises to some percent (typically 10%) of its maximum amplitude.
 - T2 = when the output DC voltage rises to some percent (typically 90%) of its maximum amplitude.
- Turn Off – determines how fast a turned off power supply takes to reduce its output voltage to some percent of maximum. Turn off time is the time between T2 and T1 where:
 - T1 = when the input voltage last falls to some percent (typically 10%) of its maximum amplitude.
 - T2 = when the output DC voltage last falls to some percent (typically 10%) of its maximum amplitude.

2 Press the **Settings** softkey.

3 In the Power Application Turn-On/Turn-Off Menu, press the **Type** softkey to select the type of power that is being converted from the input to the output.

Your selection affects how the efficiency is measured.

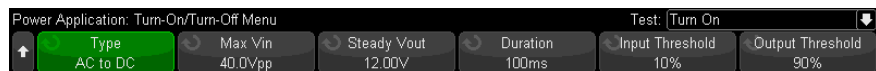

4 Press the **Type** softkey; then, turn the Entry knob to select the type of power that is being converted from the input to the output. Your selection affects how the measurements are made.

- 5 Press the **Max Vin** softkey; then, turn the Entry knob to specify the maximum input voltage.

Enter the maximum (peak-to-peak) source voltage amplitude. The source voltage will be used to trigger the oscilloscope in "Turn On Time" test.

This value is used to adjust the vertical scale of the channel probing the oscilloscope input voltage.

- 6 Press the **Steady Vout** softkey; then, turn the Entry knob to specify the expected steady state output DC voltage of the power supply.

This value is used to adjust the vertical scale of the channel probing the oscilloscope output voltage.

- 7 Press the **Duration** softkey; then, turn the Entry knob to select the time scale of the measurement.

- 8 Press the **Input Threshold** softkey; then, turn the Entry knob to specify the percent of maximum amplitude that identifies T1.

In Turn On analysis, the rising input voltage threshold is typically 10%.

In Turn Off analysis, the falling input voltage threshold is typically 10%.

- 9 Press the **Output Threshold** softkey; then, turn the Entry knob to specify the percent of maximum amplitude that identifies T2.

In Turn On analysis, the rising output voltage threshold is typically 90%.

In Turn Off analysis, the falling output voltage threshold is typically 10%.

- 10 Press the  Back/Up key to return to the Power Application main menu.

Analysis Results

To perform the analysis, press **Apply** in the Power Application main menu.

Follow the instructions on screen. When the analysis has completed, results are displayed.

3 Performing Power Analysis

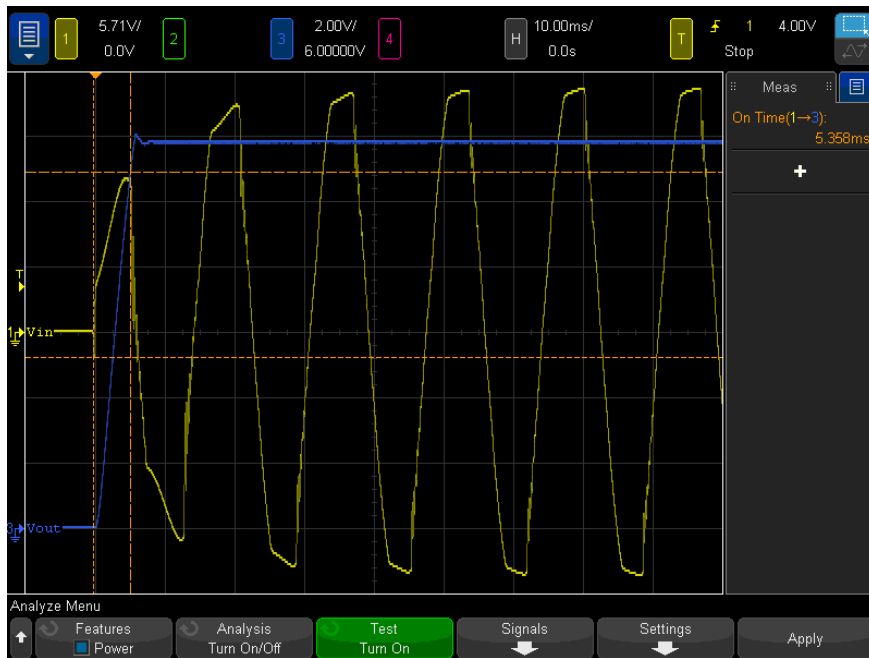

The input and output voltage waveforms are displayed. Also displayed is this automatic power measurements:

- **“Turn On Time”** on page 90
- **“Turn Off Time”** on page 91

Transient Response

The Transient Response analysis determines how fast a power supply's output voltage responds to change at the output load. This time is from when the output voltage first exits the settling band to when it last enters the settling band.

- Signals Setup**
- 1 With the **Transient Response** analysis selected in the Power Application main menu, press the **Signals** softkey.
 - 2 Connect your probes to the device under test and to the oscilloscope as shown in the connection diagram.

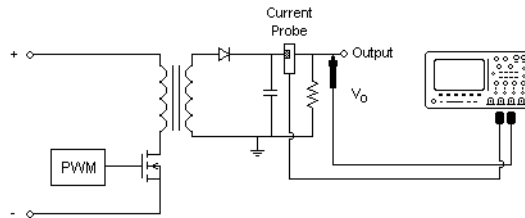



Figure 12 Typical Configuration for Power Output Transient Response

- a Connect the voltage probe (passive or differential) to the DC output of the power supply.
 - b Connect the voltage probe to an oscilloscope input channel.
 - c Connect the current probe to the output load of the power supply.
The change in the load current will be used to trigger the oscilloscope to capture the transients.
 - d Connect the current probe to an oscilloscope input channel.
- 3** Press the **Voltage** and **Current** softkeys and make sure the proper analog channel is selected.



- 4 Make sure the proper probe attenuation factors are set in the oscilloscope for the voltage and current probes.
- 5 Press the **Duration** softkey; then, turn the Entry knob to select the time scale of the measurement.
- 6 Press the **Overshoot** softkey; then, turn the Entry knob to specify the % of overshoot of the output voltage.
This value will be used to determine the settling band value for the transient response and to adjust the vertical scale of the oscilloscope.
- 7 Press the **Steady Vout** softkey; then, turn the Entry knob to specify the expected steady state output DC voltage of the power supply.

This value is used along with the overshoot percentage to specify the settling band for the transient response and to adjust the vertical scale of the oscilloscope.

8 Press the  Back/Up key to return to the Power Application main menu.

Settings

- 1 In the Power Application main menu, press the **Settings** softkey.
- 2 In the Power Application Transient Menu, make the appropriate settings.



Table 7 Transient Response Analysis Settings

Setting	Description	Notes
Low Current	Enter the low current value. This is the expected low current value before or after a load change.	The low current value and the high current value are used to calculate the trigger level and to adjust the vertical scale of the oscilloscope. As the load changes, and the current goes from the low value to the high (or vice-versa), the oscilloscope triggers and makes the transient response settling time measurement.
High Current	Enter the high current value. This is the expected high current value before or after a load change.	

3 When you have finished changing the settings, press the  Back/Up key to return to the Power Application main menu.

Analysis Results

To perform the analysis, press **Apply** in the Power Application main menu.

Follow the instructions on screen. When the analysis has completed, results are displayed.



The voltage and current waveforms are displayed. There are start and end time stamps that mark the measured area. Also displayed is this automatic power measurements:

- **"Transient"** on page 89

Efficiency

Efficiency analysis tests the overall efficiency of the power supply by measuring the output power over the input power. This analysis requires a 4-channel oscilloscope because input voltage, input current, output voltage, and output current are measured.

- Signals Setup**
- 1 With the **Efficiency** analysis selected in the Power Application main menu, press the **Signals** softkey.
 - 2 Connect your probes to the device under test and to the oscilloscope as shown in the connection diagram.

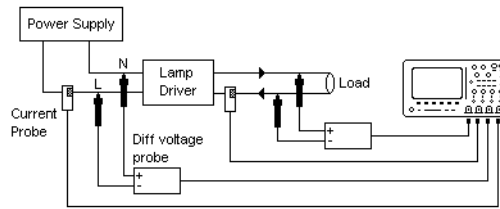



Figure 13 Typical Configuration for Efficiency Analysis Tests

- a Connect D+ of the input voltage probe to the live wire of the AC input.
 - b Connect D- of the input voltage probe to the neutral of the AC input.
 - c On the input voltage probe, select the appropriate attenuation ratio.
 - d Connect the input current probe to the live wire of the AC input with the direction of the arrow pointing towards the current flow.
 - e Connect D+ of the output voltage probe to the input path of the load.
 - f Connect D- of the output voltage probe to the return path of the load.
 - g On the output voltage probe, select the appropriate attenuation ratio.
 - h Connect the output current probe to the input path of the load with the direction of the arrow pointing towards the current flow.
 - i Connect the voltage and current probes to the oscilloscope input channels.
- 3** Press the **Input V**, **Input I**, **Output V**, and **Output I** softkeys and make sure the proper analog channels are selected.



- 4** Make sure the proper probe attenuation factors are set in the oscilloscope for the voltage and current probes.
- 5** Press the **Duration** softkey; then, turn the Entry knob to specify the time to capture signals. This sets the time scale of the oscilloscope.
- 6** Press the **Auto Setup** softkey to automatically set the vertical scale and position of the voltage and current channels.

7 Press the  Back/Up key to return to the Power Application main menu.

Settings 1 Press the **Type** softkey to select the type of power that is being converted from the input to the output.

Your selection affects how the efficiency is measured.

Analysis Results To perform the analysis, press **Apply** in the Power Application main menu.

When the analysis has completed, results are displayed.

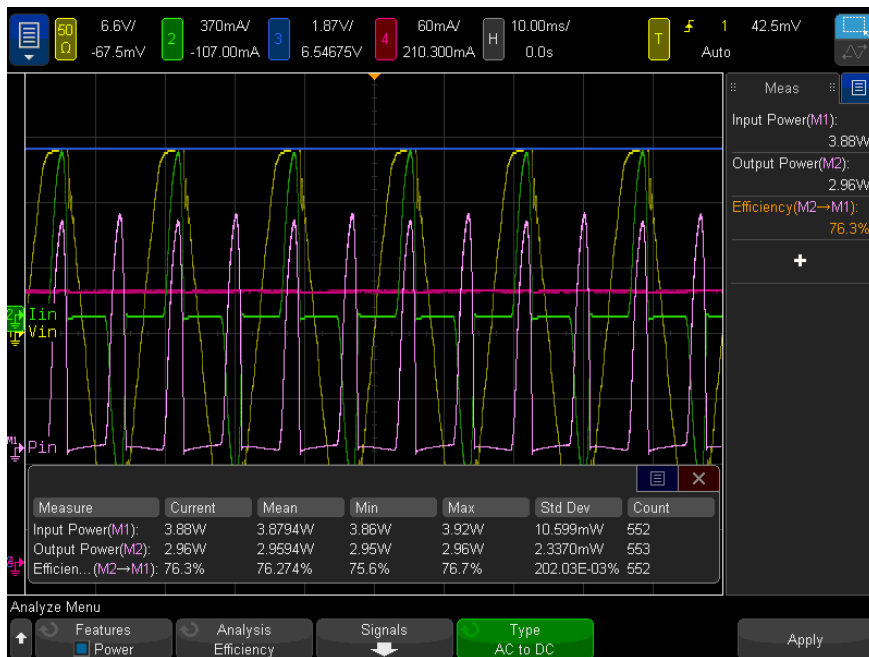

The input voltage, input current, output voltage, and output current waveforms are displayed, as well as the input power waveform (waveform math multiply of the input voltage and current). Also displayed are these automatic power measurements and statistics:

- "Input Power" on page 85
- "Output Power" on page 86
- "Efficiency" on page 87

Automatic Measurements

You can add these relevant automatic measurements using the **[Meas]** key and menu.

Automatic Power App measurements:

- **"Real Power"** on page 79
- **"Apparent Power"** on page 80
- **"Reactive Power"** on page 81
- **"Power Factor"** on page 78
- **"Phase Angle"** on page 83

Automatic Voltage measurements (refer to oscilloscope *User's Guide* for more information):

- AC - RMS
- DC - RMS
- Maximum
- Minimum
- Peak-Peak

Automatic Time measurements (refer to oscilloscope *User's Guide* for more information):

- Frequency
- Phase

Frequency Response Measurements

- **“Power Supply Rejection Ratio (PSRR)”** on page 65
- **“Control Loop Response (Bode)”** on page 71

Power Supply Rejection Ratio (PSRR)

The Power Supply Rejection Ratio (PSRR) test is used to determine how well a voltage regulator rejects ripple noise over different frequency range.

This analysis provides a signal from the oscilloscope's waveform generator that sweeps its frequency. This signal is used to inject ripple to the DC voltage that feeds the voltage regulator.

The AC RMS ratio of the input over the output is measured and is plotted over the range of frequencies.

There are many different ways to measure PSRR. Because the oscilloscope has a higher noise floor and lower sensitivity than a network analyzer, it is difficult to measure PSRR any better than -60 dB. The PSRR test using the oscilloscope is usually acceptable for spot-checking overall PSRR behavior of a power supply under test.

- Signals Setup**
- 1** Connect your probes to the device under test and to the oscilloscope as shown in the connection diagram.

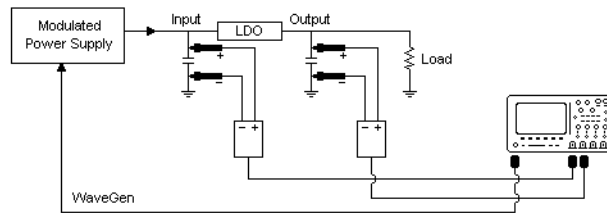

Figure 14 Typical Configuration for Power Supply Rejection Ratio Analysis

- a Connect one voltage probe (passive or differential) to the input of the low-dropout (LDO) regulator (and ground).
- b Connect a second voltage probe (passive or differential) to the output of the low-dropout (LDO) regulator (and ground).
- c Connect the waveform generator output to the modulated power supply.

One example of a modulated power supply is the **TS200** Option 1A from Accel Instruments. You can also use an injection transformer to inject the oscilloscope's WaveGen signal to a power supply output that is connected to the low-dropout (LDO) regulator. In this case, the injection transformer and power supply combination replaces a modulated power supply (like TS200).

- 2 Make sure the proper probe attenuation factors are set in the oscilloscope for the voltage probes.

Settings

- 1 With the **Power Supply Rejection Ratio (PSRR)** analysis selected in the Power Application main menu, press the **Setup & Apply...** softkey.
- 2 In the Power Supply Rejection Ratio (PSRR) dialog box, make the appropriate settings:



Setting	Description
Frequency Mode	You can Sweep through a range of frequencies or perform the analysis at a Single frequency. The Single mode is useful for evaluating amplitudes at a single frequency. After running the test at a single frequency, you can manually adjust (increase) the waveform generator's amplitude until you begin to observe distortion in the waveforms on the oscilloscope's display. You can then use that amplitude at all frequencies in Sweep mode, or you can evaluate amplitudes at other frequencies in order to determine an optimized amplitude profile (using the Amplitude Profile option).
Frequency (Start, Stop)	Sets the start and stop sweep frequency values. The measurement is displayed on a log scale, so you can select the start frequency from decade values, and you can select the stop frequency from decade values in addition to the maximum frequency of 20 MHz.
Points Per Decade	Selects the number of frequency test points per decade (in the log scale).
Source (Input, Output)	Make sure the proper analog channels are selected.

Setting	Description
WaveGen (Amp, Imp)	<p>Sets the waveform generator amplitude value and expected output load impedance.</p> <p>The output impedance of the Gen Out signal is fixed at 50 ohms. However, the output load selection lets the waveform generator display the correct amplitude and offset levels for the expected output load. If the actual load impedance is different than the selected value, the displayed amplitude and offset levels will be incorrect.</p>
Amplitude Profile	<p>Select this check box to be able to specify initial waveform generator ramp amplitudes for each frequency range.</p> <p>With amplitude profiling, you can use lower amplitudes at frequencies where the device under test (DUT) is sensitive to distortion and use higher amplitudes where the DUT is less sensitive to distortion.</p> <p>You can often observe distortions during the test. If the input test sine wave begins to look lopsided, clipped, or somewhat triangular in shape (nonsinusoidal), you are probably encountering distortion due to overdriving your DUT. Optimizing test amplitudes to achieve the best dynamic range measurements is often an iterative process of running your frequency response measurements multiple times.</p>

Analysis Results To perform the analysis, press **Apply** in the Power Application Rejection Ratio (PSRR) dialog box. Measured values are plotted on the frequency chart as the analysis is performed. When the analysis completes, the plot remains displayed in the dialog box. You can also press the **Plot...** softkey to display the plot.



The plot shows the measured PSRR versus frequency. There are two markers that can be positioned using the touch screen or a connected USB mouse. There is a control in the upper right corner for adjusting the scale/offset of the plot or autoscaling. On the right side of the plot are sliders for adjusting the PSRR plot's scale (upper slider) and offset (lower slider).

To view a table of the analysis results, press the **Table...** softkey.

3 Performing Power Analysis

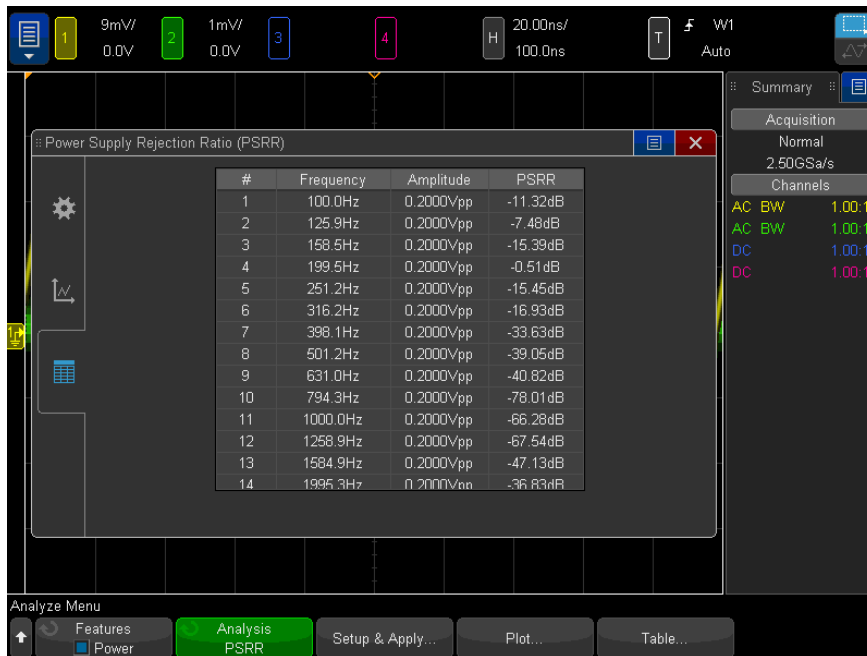

The table shows: the data point number, the frequency, the waveform generator output amplitude, and the measured PSRR. You can use the touch screen or a connected USB mouse to scroll the data. Click a row to run the test at a **Single** frequency (which is useful for evaluating amplitudes at a single frequency).

Saving (or Emailing) Analysis Results

To save the analysis results to a USB storage device (or email them):

- 1 Press the **[Save/Recall]** key.
- 2 In the Save/Recall Menu, press the **Save** (or **Email**) softkey.
- 3 In the Save (or Email) Menu, press the **Format** softkey and turn the Entry knob to select **Power Supply Rejection Ratio (PSRR) data (*.csv)**.
- 4 Press the softkey in the second position and use the Entry knob to navigate to the save location (or configure email). See the oscilloscope *User's Guide* for information on navigating storage locations (and configuring email).
- 5 Finally, press the **Press to Save** (or **Press to Send Email**) softkey.

A message indicating whether the save (or email) was successful is displayed.

Control Loop Response (Bode)

The Control Loop Response (Bode) analysis performs a gain/phase plot over frequency sweep. This is used to determine the margin of a control loop.

Phase measurements and plots are only possible if the input and output waveforms exceed 1 division peak-to-peak (>1 mVpp).

- Signals Setup**
- 1 Connect your probes to the device under test and to the oscilloscope as shown in the connection diagram.

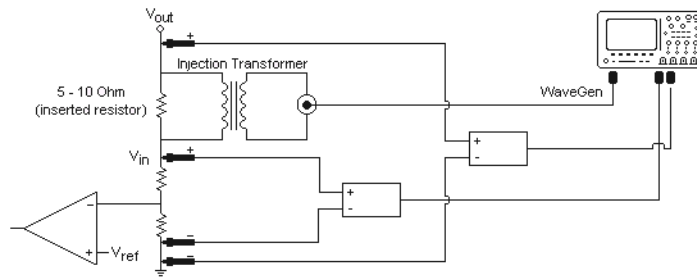

Figure 15 Typical Configuration for Control Loop Response Analysis

- a Connect one voltage probe (passive or differential) to the input of the injection resistor (and ground).
- b Connect a second voltage probe (passive or differential) to the output of the injection resistor (and ground).
- c Connect the waveform generator output to the injection transformer that is connected in parallel with a low-ohm injection resistor.

The injection resistor should be placed at the low impedance output node above the high side feedback resistor in the feedback path.

- 2 Make sure the proper probe attenuation factors are set in the oscilloscope for the voltage probes.

- Settings**
- 1 In the Power Application main menu, press the **Setup & Apply...** softkey.
 - 2 In the Control Loop Response (Bode) dialog box, make the appropriate settings:

3 Performing Power Analysis

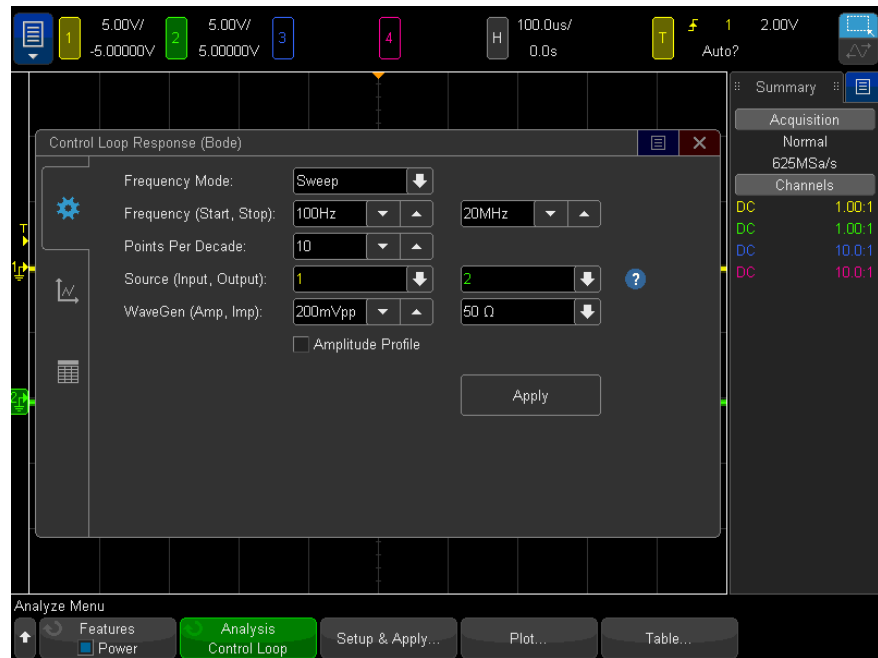

Setting	Description
Frequency Mode	You can Sweep through a range of frequencies or perform the analysis at a Single frequency. The Single mode is useful for evaluating amplitudes at a single frequency, for example, near the expected 0 dB cross-over frequency. After running the test at a single frequency, you can manually adjust (increase) the waveform generator's amplitude until you begin to observe distortion in the waveforms on the oscilloscope's display. You can then use that amplitude at all frequencies in Sweep mode, or you can evaluate amplitudes at other frequencies in order to determine an optimized amplitude profile (using the Amplitude Profile option).
Frequency (Start, Stop)	Sets the start and stop sweep frequency values. The measurement is displayed on a log scale, so you can select the start frequency from decade values, and you can select the stop frequency from decade values in addition to the maximum frequency of 20 MHz.
Points Per Decade	Selects the number of frequency test points per decade (in the log scale).

Setting	Description
Source (Input, Output)	Make sure the proper analog channels are selected.
WaveGen (Amp, Imp)	<p>Sets the waveform generator amplitude value and expected output load impedance.</p> <p>The output impedance of the Gen Out signal is fixed at 50 ohms. However, the output load selection lets the waveform generator display the correct amplitude and offset levels for the expected output load. If the actual load impedance is different than the selected value, the displayed amplitude and offset levels will be incorrect.</p>
Amplitude Profile	<p>Select this check box to be able to specify initial waveform generator ramp amplitudes for each frequency range.</p> <p>With amplitude profiling, you can use lower amplitudes at frequencies where the device under test (DUT) is sensitive to distortion and use higher amplitudes where the DUT is less sensitive to distortion. Power supply feedback networks are typically most sensitive near the 0 dB cross-over frequency.</p> <p>You can often observe distortions during the test. If the input test sine wave begins to look lopsided, clipped, or somewhat triangular in shape (nonsinusoidal), you are probably encountering distortion due to overdriving your DUT. Optimizing test amplitudes to achieve the best dynamic range measurements is often an iterative process of running your frequency response measurements multiple times.</p>

Analysis Results To perform the analysis, press **Apply** in the Control Loop Response (Bode) dialog box. Measured values are plotted on the frequency chart as the analysis is performed. When the analysis completes, the plot remains displayed in the dialog box. You can also press the **Plot...** softkey to display the plot.

3 Performing Power Analysis



The plot shows both gain and phase measurements versus frequency. Notice there is a phase reference point at 0 dB/0° (which is different than some text book descriptions of Bode plots that use a phase reference point of 0 dB/-180°). There are two pairs of markers that can be positioned using the touch screen or a connected USB mouse. Phase margin (PM) and gain margin (GM) measurements are also shown at the bottom of the dialog box. There is a control in the upper right corner for adjusting the scale/offset of the plots or autoscaling. On the right side of the plot are sliders for adjusting the gain plot's scale (upper slider) and offset (lower slider). On the left side of the plot are sliders for adjusting the phase plot's scale (upper slider) and offset (lower slider).

To view a table of the analysis results, press the **Table...** softkey.



The table shows: the data point number, the frequency, the waveform generator output amplitude, the measured gain, and the measured phase. You can use the touch screen or a connected USB mouse to scroll the data. Click a row to run the test at a **Single** frequency (which is useful for evaluating amplitudes at a single frequency).

Saving (or Emailing) Analysis Results

To save the analysis results to a USB storage device (or email them):

- 1 Press the **[Save/Recall]** key.
- 2 In the Save/Recall Menu, press the **Save** (or **Email**) softkey.
- 3 In the Save (or Email) Menu, press the **Format** softkey and turn the Entry knob to select **Control Loop Response (Bode) data (*.csv)**.
- 4 Press the softkey in the second position and use the Entry knob to navigate to the save location (or configure email). See the oscilloscope *User's Guide* for information on navigating storage locations (and configuring email).
- 5 Finally, press the **Press to Save** (or **Press to Send Email**) softkey.

A message indicating whether the save (or email) was successful is displayed.

3 Performing Power Analysis

4 Automatic Power Measurements

Power Factor /	78
Real Power /	79
Apparent Power /	80
Reactive Power /	81
Crest Factor /	82
Phase Angle /	83
Output Ripple /	84
Input Power /	85
Output Power /	86
Efficiency /	87
Peak Current /	88
Transient /	89
Turn On Time /	90
Turn Off Time /	91
R _{ds(on)} /	92
V _{ce(sat)} /	93
Power Loss /	94
Power Loss/Cyc /	95
Energy Loss /	96

Power Factor

Ratio of the actual AC line power to the apparent power.

Real Power / Apparent Power

The power factor measurement is made using two source inputs, the voltage waveform and the current waveform, and it also requires a math multiply waveform of the voltage and current waveforms.

Real Power

The portion of power flow that, averaged over a complete cycle of the AC waveform, results in net transfer of energy in one direction.

$$\text{Real Power} = \sqrt{\frac{1}{N} \sum_{n=0}^{N-1} V_n I_n}$$

The real power measurement is made on one source input that represents power. This is typically a math multiply waveform of the voltage and current waveforms.

Apparent Power

The portion of AC line power flow due to stored energy, which returns to the source in each cycle.

$IRMS * VRMS$

The apparent power measurement is made using two source inputs, the voltage waveform and the current waveform.

Reactive Power

The difference between apparent power and real power due to reactance. Using the *power triangle* (the right triangle where $\text{apparent_power}^2 = \text{real_power}^2 + \text{reactive_power}^2$):

$$\text{Reactive Power} = \sqrt{\text{Apparent Power}^2 - \text{Real Power}^2}$$

Measured in VAR (Volts-Amps-Reactive)

The reactive power measurement is made using two source inputs, the voltage waveform and the current waveform, and it also requires a math multiply waveform of the voltage and current waveforms.

Crest Factor

Crest factor is the ratio between the instantaneous peak AC line current/voltage required by the load and the RMS current/voltage.

Select the voltage source for V crest factor: $V_{\text{peak}} / V_{\text{RMS}}$

Select the current source for I crest factor: $I_{\text{peak}} / I_{\text{RMS}}$

Phase Angle

In the *power triangle* (the right triangle where $\text{apparent_power}^2 = \text{real_power}^2 + \text{reactive_power}^2$), phase angle is the angle between the apparent power and the real power, indicating the amount of reactive power. Small phase angles equate to less reactive power.

The phase angle measurement is made using two source inputs, the voltage waveform and the current waveform, and it also requires a math multiply waveform of the voltage and current waveforms.

Output Ripple

$V_{Max} - V_{Min}$

The output ripple measurement is made on one source input that is the output voltage waveform.

Input Power

Input V * Input I

The input power measurement is made using two source inputs, the input voltage waveform and the input current waveform, and it also requires a math multiply waveform of the voltage and current waveforms.

The input power measurement requires that you specify the channels probing the input voltage, input current, output voltage, and output current in the Power Application Signals Menu and that you perform the automated signals setup by pressing the **Auto Setup** softkey in the same menu.

Output Power

Output V * Output I

The output power measurement is made using two source inputs, the output voltage waveform and the output current waveform, and it also requires a math multiply waveform of the voltage and current waveforms.

The output power measurement requires that you specify the channels probing the input voltage, input current, output voltage, and output current in the Power Application Signals Menu and that you perform the automated signals setup by pressing the **Auto Setup** softkey in the same menu.

Efficiency

Output power / input power.

The efficiency measurement is made on one source input that represents input power. This is typically a math multiply waveform of the input voltage and input current waveforms. This measurement also requires the output voltage waveform and the output current waveform specified in the signals setup for the Efficiency power analysis.

The efficiency measurement requires that you specify the channels probing the input voltage, input current, output voltage, and output current in the Power Application Signals Menu and that you perform the automated signals setup by pressing the **Auto Setup** softkey in the same menu.

Peak Current

The Peak Current can be a positive or negative value, so the result is the larger of the measured maximum or minimum.

The peak current measurement is made on one source input that is the current waveform.

Transient

Transient response time = $t_2 - t_1$, where:

- t_1 = The first time a voltage waveform exits the settling band.
- t_2 = The last time it enters into the settling band.
- Settling band = +/- overshoot % of the steady state output voltage.

The transient measurement is made using X cursors on the output voltage signal.

Turn On Time

Turn On time = $t_2 - t_1$, where:

- t_1 = AC input voltage rises to 10% of its maximum amplitude (Start Time).
- t_2 = DC output voltage rises to 90% of its maximum amplitude (End Time).

The turn on time measurement is made using X cursors on two source inputs, the input voltage waveform and the output voltage waveform.

Turn Off Time

Turn Off time = $t_2 - t_1$, where:

- t_1 = AC input voltage goes below 10% of its positive peak (or negative peak which ever occurs first) (Start Time).
- t_2 = DC output voltage drops to 10% of its steady state value (End Time).

The turn on time measurement is made using X cursors on two source inputs, the input voltage waveform and the output voltage waveform.

Rds(on)

Rds(on) is a switching device characteristic that can be measured by the Rds(on) and Vce(sat) power analysis.

The Rds(on) characteristic is also published in the switching device data sheet.

Vce(sat)

Vce(sat) is a switching device characteristic that can be measured by the Rds(on) and Vce(sat) power analysis.

The Vce(sat) characteristic is also published in the switching device data sheet.

Power Loss

$P_n = V_{ds_n} * I_{d_n}$, where n is each sample.

The power loss measurement is made on one source input that represents power. This is typically a math multiply waveform of the voltage and current waveforms.

Power Loss/Cyc

$P_n = (V_{ds_n} * I_{d_n}) * (\text{Time range of zoom window}) * (\text{Counter measurement of the voltage of the switching signal})$, where n is each sample.

The power loss per cycle measurement is made on one source input that represents power. This is typically a math multiply waveform of the voltage and current waveforms.

This measurement operates when in zoom mode and the counter measurement is installed on the voltage of the switching signal.

Energy Loss

= $\sum (V_{ds_n} * I_{d_n})$ * sample size, where n is each sample.

The energy loss measurement is made on one source input that represents power. This is typically a math multiply waveform of the voltage and current waveforms.

Index

Symbols

% overshoot, 59

Numerics

10070D passive probe, 13
1141A differential probe, 13
1147B current probe, 14
3000T X-Series oscilloscopes, 12
4000 X-Series oscilloscopes, 12
6000 X-Series oscilloscopes, 12

A

accessing the Power Measurement Application, 16
apparent power, 3, 30, 80
at a glance, 3
Average, power modulation analysis, 50

B

band width (oscilloscope) requirements, 11
Blackman-Harris window, 32
block diagram, switch-mode power supply, 3

C

channel deskew, performing, 17
conduction, 45
conduction loss, 3, 42
configuration (test) parameters, 23
connection to device under test, 21
control loop response (Bode), 71
control loop response (Bode) settings, 71
control loop response (Bode) signals, 71

copyright, 2
crest factor, 3, 31, 82
current harmonics, 31
current harmonics analysis settings, 33
current harmonics analysis signals, 31
current harmonics Class D settings, 33
current harmonics plot parameter, 33
current harmonics standard parameter, 33
current harmonics test results, 34
current probe, 13
current probe attenuation factor parameter, 22
current switching level, 45

D

deskew (channel), performing, 17
deskew fixture (U1880A), 14, 17
device under test, connection to, 21
dI/dt, 3, 49
dI/dt test results, 49
differential probe, high-voltage, 13
duration for turn on/off analysis, 57
duration of Efficiency analysis, 62
duration of load change, 59
duration of Modulation analysis, 50
duration of output ripple analysis, 54
Duty Cycle, power modulation analysis, 50
dV/dt, 3, 49
dV/dt test results, 49

E

efficiency analysis signals, 61
efficiency, power app automatic measurement, 87
energy loss, 96
expected inrush current, 37

F

Fall Time, power modulation analysis, 50
FFT waveform (plot), 35
Frequency, power modulation analysis, 50

G

gain margin (GM), 74
getting started, 15
GM (gain margin), 74

H

Hamming window, 32
Hanning window, 32
harmonic, 35
high load current parameter, 60
high-voltage differential probe, 13

I

I crest factor, 82
IEC 61000-3-2 standard, 3, 33
input power, 85
inrush current, 36
inrush current analysis, 36
inrush current analysis signals, 36
inrush current test results, 37

L

line frequency parameter, 33
load transient response test results, 60
low load current, 60

M

maximum source voltage, 57

- memory (oscilloscope)
 - requirements, 11
 - modulation, 49
 - modulation analysis, 3
 - modulation analysis settings, 50
 - modulation analysis signals, 49
- N**
- N2780A current probe, 14
 - N2781A current probe, 14
 - N2782A current probe, 14
 - N2783A current probe, 14
 - N2790A high-voltage differential probe, 13
 - N2791A high-voltage differential probe, 13
 - N2792A differential probe, 13
 - N2793A differential probe, 13
 - N2870A passive probe, 13
 - N2891A high-voltage differential probe, 13
 - N2893A current probe, 14
 - negative Duty Cycle, power modulation analysis, 50
 - negative pulse width, power modulation analysis, 50
 - noise floor, 45
 - notices, 2
 - null offset, 45
 - number of cycles, 29, 32
- O**
- oscilloscope band width
 - requirements, 11
 - oscilloscope memory requirements, 11
 - oscilloscope probe requirements, 13
 - oscilloscope requirements, 11
 - oscilloscope software version
 - requirements, 12
 - output noise, 3
 - output power, 86
 - output ripple, 84
 - output ripple analysis signals, 53
 - output voltage ripple, 53
 - output voltage ripple test results, 54
 - overall efficiency, 61
 - overall efficiency test results, 63
- P**
- overall system efficiency, 87
 - overview, 3
- P**
- parameters, test configuration, 23
 - passive probe, 13
 - peak current, 88
 - percent overshoot, 59
 - Period, power modulation analysis, 50
 - phase angle, 31, 83
 - phase margin (PM), 74
 - PM (phase margin), 74
 - positive pulse width, power modulation analysis, 50
 - power factor, 3, 30, 78
 - power loss, 94
 - power loss per cycle, 95
 - power measurements, more about, 27
 - power quality, 3, 28
 - power quality analysis signals, 28
 - power quality test results, 29
 - power supply rejection ratio (PSRR), 65
 - power supply rejection ratio (PSRR) settings, 66
 - power supply rejection ratio (PSRR) signals, 65
 - pre-compliance testing, 3
 - prerequisites, 9
 - probe (oscilloscope) requirements, 13
 - probe (oscilloscope), current, 13
 - probe (oscilloscope), high-voltage differential, 13
 - probe (oscilloscope), passive, 13
 - PSRR (Power Supply Rejection Ratio), 4
 - PWM (pulse width modulation), 3
- R**
- Ratio, power modulation analysis, 50
 - R_{ds} (dynamic ON resistance)
 - waveform, 45
 - R_{ds(on)}, 92
 - R_{ds(on)} and V_{ce(sat)}, 39
 - R_{ds(on)} and V_{ce(sat)} analysis results, 40
 - reactive power, 30, 81
 - real (actual) power, 30, 79
 - requirements, current probe, 13
- requirements, deskew fixture, 14**
- requirements, high-voltage differential probe, 13**
- requirements, oscilloscope, 11**
- requirements, oscilloscope**
- band width, 11
- requirements, oscilloscope memory, 11**
- requirements, oscilloscope probe, 13**
- requirements, oscilloscope software**
- version, 12
- requirements, passive probe, 13**
- results (test), viewing, 25**
- ripple measurements, 3**
- Rise Time, power modulation analysis, 50**
- RMS - AC, power modulation analysis, 50**
- running tests, 24**
- S**
- safety, 10
 - selecting tests, 20
 - slew rate analysis settings, 48
 - slew rate analysis signals, 47
 - slew rate of I_d in power device, 49
 - slew rate of V_ds in power device, 49
 - slew rate power analysis, 46
 - software (oscilloscope) version
 - requirements, 12
 - software version (oscilloscope)
 - requirements, 12
 - steady state DC output voltage, 57, 59
 - switching loss, 3, 42
 - switching loss analysis settings, 44
 - switching loss analysis signals, 39, 42
 - switching loss test results, 45
 - switch-mode power supply block diagram, 3
- T**
- test configuration, 23
 - test results, viewing, 25
 - test selection, 20
 - tests, running, 24
 - THD (total harmonic distortion), 35
 - total harmonic distortion, 3
 - transient response, 58

- transient response analysis, 58
- transient response analysis settings, 60
- transient response analysis signals, 58
- transient response time, 89
- true power, 3
- turn off time, 56, 91
- turn off time test results, 57
- turn on time, 56, 90
- turn on time test results, 57
- turn on/off analysis, 55
- turn on/off analysis settings, 56
- turn on/off analysis signals, 55

U

- U1880A deskew fixture, 14, 17

V

- V crest factor, 82
- Vce(sat), 93
- Vce(sat) and Rds(on), 39
- Vce(sat) and Rds(on) analysis results, 40
- viewing test results, 25
- viewing waveforms, 25
- voltage (high) differential probe, 13
- voltage probe attenuation factor parameter, 21
- voltage switching level, 45

W

- warranty, 2
- waveforms, viewing, 25
- window parameter (FFT analysis), 32

