

---

# 2050/60 X-Series Wide Dynamic Range Power Sensors

Wide dynamic range power sensors for any modulated signals

# Notices

## Copyright Notice

© Keysight Technologies 2015–2021  
No part of this manual may be reproduced in any form or by any means (including electronic storage and retrieval or translation into a foreign language) without prior agreement and written consent from Keysight Technologies as governed by United States and international copyright laws.

## Manual Part Number

U2063-90002

## Edition

Edition 5, February 5, 2024

## Printed in:

Printed in Malaysia

## Published by:

Keysight Technologies  
Bayan Lepas Free Industrial Zone,  
11900 Penang, Malaysia

## Technology Licenses

The hardware and/or software described in this document are furnished under a license and may be used or copied only in accordance with the terms of such license.

## Declaration of Conformity

Declarations of Conformity for this product and for other Keysight products may be downloaded from the Web. Go to <http://www.keysight.com/go/conformity>. You can then search by product number to find the latest Declaration of Conformity.

## U.S. Government Rights

The Software is “commercial computer software,” as defined by Federal Acquisition Regulation (“FAR”) 2.101. Pursuant to FAR 12.212 and 27.405-3 and Department of Defense FAR Supplement (“DFARS”) 227.7202, the U.S. government acquires commercial computer software under the same terms by which the software is customarily provided to the public. Accordingly, Keysight provides the Software to U.S. government customers under its standard commercial license, which is embodied in its End User License Agreement (EULA), a copy of which can be found at <http://www.keysight.com/find/sweula>. The license set forth in the EULA represents the exclusive authority by which the U.S. government may use, modify, distribute, or disclose the Software. The EULA and the license set forth therein, does not require or permit, among other things, that Keysight: (1) Furnish technical information related to commercial computer software or commercial computer software documentation that is not customarily provided to the public; or (2) Relinquish to, or otherwise provide, the government rights in excess of these rights customarily provided to the public to use, modify, reproduce, release, perform, display, or disclose commercial computer software or commercial computer software documentation. No additional government requirements beyond those set forth in the EULA shall apply, except to the extent that those terms, rights, or licenses are explicitly required from all providers of commercial computer software pursuant to the FAR and the DFARS and are set forth specifically in writing elsewhere in the EULA. Keysight shall be under no obligation to update, revise or otherwise modify the Software. With respect to any technical data as defined by FAR 2.101, pursuant to FAR 12.211 and 27.404.2 and DFARS 227.7102, the U.S. government acquires no greater than Limited Rights as defined in FAR 27.401 or DFAR 227.7103-5 (c), as applicable in any technical data.

## Warranty

THE MATERIAL CONTAINED IN THIS DOCUMENT IS PROVIDED “AS IS,” AND IS SUBJECT TO BEING CHANGED, WITHOUT NOTICE, IN FUTURE EDITIONS. FURTHER, TO THE MAXIMUM EXTENT PERMITTED BY APPLICABLE LAW, KEYSIGHT DISCLAIMS ALL WARRANTIES, EITHER EXPRESS OR IMPLIED, WITH REGARD TO THIS MANUAL AND ANY INFORMATION CONTAINED HEREIN, INCLUDING BUT NOT LIMITED TO THE IMPLIED WARRANTIES OF MERCHANTABILITY AND FITNESS FOR A PARTICULAR PURPOSE. KEYSIGHT SHALL NOT BE LIABLE FOR ERRORS OR FOR INCIDENTAL OR CONSEQUENTIAL DAMAGES IN CONNECTION WITH THE FURNISHING, USE, OR PERFORMANCE OF THIS DOCUMENT OR FOR ANY INFORMATION CONTAINED HEREIN. SHOULD KEYSIGHT AND THE USER HAVE A SEPARATE WRITTEN AGREEMENT WITH WARRANTY TERMS COVERING THE MATERIAL IN THIS DOCUMENT THAT CONFLICT WITH THESE TERMS, THE WARRANTY TERMS IN THE SEPARATE AGREEMENT SHALL CONTROL.

## Safety Information

### CAUTION

A CAUTION notice denotes a hazard. It calls attention to an operating procedure, practice, or the like that, if not correctly performed or adhered to, could result in damage to the product or loss of important data. Do not proceed beyond a CAUTION notice until the indicated conditions are fully understood and met.

### WARNING

A WARNING notice denotes a hazard. It calls attention to an operating procedure, practice, or the like that, if not correctly performed or adhered to, could result in personal injury or death. Do not proceed beyond a WARNING notice until the indicated conditions are fully understood and met.

## Environmental Conditions

The 2050/60 X-Series is designed for indoor use and in an area with low condensation. The table below shows the general environmental requirements for this instrument.







Environmental condition	Requirement
Temperature	Operating condition - 0 °C to 55 °C
	Storage condition - -40 °C to 70 °C
Humidity	Operating condition - Up to 95% RH at 40°C (non-condensing)
	Storage condition - Up to 90% RH at 65°C (non-condensing)
Altitude	Operating condition - Up to 3000 m (9840 ft)
	Storage condition - Up to 15420 m (50000 ft)

## Regulatory Information

The 2050/60 X-Series complies with the following Electromagnetic Compatibility (EMC) compliances:

- IEC 61326-1/EN 61326-1
- Canada: ICES/NMB-001
- Australia/New Zealand: AS/NZS CISPR11

# Regulatory Markings

 <p>The RCM mark is a registered trademark of the Spectrum Management Agency of Australia.</p> <p>This signifies compliance with the Australian EMC Framework Regulations under the terms of the Radio Communications Act of 1992.</p>	 <p>The CE mark is a registered trademark of the European Community. This CE mark shows that the product complies with all the relevant European Legal Directives.</p> <p>ICES/NMB-001 indicates that this ISM product complies with the Canadian ICES-001. Cet appareil ISM est conforme a la norme NMB-001 du Canada.</p> <p>ISM GRP.1 Class A indicates that this is an Industrial Scientific and Medical Group 1 Class A product.</p>
 <p>This symbol indicates the time period during which no hazardous or toxic substance elements are expected to leak or deteriorate during normal use. Forty years is the expected useful life of the product.</p>	 <p>The UKCA (UK Conformity Assessed) marking is a UK product marking that is used for goods being placed on the market in Great Britain (England, Wales, and Scotland)</p>
 <p>This product complies with the WEEE Directive (2002/96/EC) marking requirement. This affixed product label indicates that you must not discard this electrical/electronic product in domestic household waste.</p>	
 <p>MSIP-REM-Kst-XXXXXXXXXX</p> <p>This symbol is a South Korean Class A EMC Declaration.</p> <p>This equipment is Class A suitable for professional use and is for use in electromagnetic environments outside of the home.</p> <p>이 기기는 업무용 (A 급) 전자파적합기기로서 판매자 또는 사용자는 이 점을 주의하시기 바라 며 , 가정외의 지역에서 사용하는 것을 목적으로 합니다.</p>	

# South Korean Class A EMC Declaration

Information to the user:

This instrument has been conformity assessed for use in business environments. In a residential environment, this equipment may cause radio interference.

This EMC statement applies to the equipment only for use in business environment.

## 사용자 안내문

이 기기는 업무용 환경에서 사용할 목적으로 적합성평가를 받은 기기로서 가정용 환경에서 사용하는 경우 전파간섭의 우려가 있습니다.

사용자 안내문은 "업무용 방송통신기자재"에만 적용한다.

# Waste Electrical and Electronic Equipment (WEEE) Directive

This instrument complies with the WEEE Directive marking requirement. This affixed product label indicates that you must not discard this electrical or electronic product in domestic household waste.

## Product category

With reference to the equipment types in the WEEE directive Annex 1, this instrument is classified as a "Monitoring and Control Instrument" product.

The affixed product label is as shown below.



Do not dispose in domestic household waste.

To return this unwanted instrument, contact your nearest Keysight Service Center, or visit <http://about.keysight.com/en/companyinfo/environment/takeback.shtml> for more information.

# Sales and Technical Support

To contact Keysight for sales and technical support, refer to the support links on the following Keysight websites:

- [www.keysight.com/find/widedynamicsensor](http://www.keysight.com/find/widedynamicsensor)  
(product-specific information and support, software and documentation updates)
- [www.keysight.com/find/assist](http://www.keysight.com/find/assist)  
(worldwide contact information for repair and service)

# Table of Contents

Environmental Conditions	3
Regulatory Information	3
Regulatory Markings	4
South Korean Class A EMC Declaration	5
Waste Electrical and Electronic Equipment (WEEE) Directive	5
Product category	5
Sales and Technical Support	6
<b>1 Getting Started</b>	
Overview	14
Theory of Operation	18
Initial Inspection	20
Standard shipped items	20
Hardware Installation and Configuration	22
Connect the USB sensor	22
Connect the LAN sensor	24
Mount the L2065XT/66XT/67XT	39
Mounting dimensions	39
Mounting procedure	40
LED Indicator Sequence During Power-Up for the USB Sensor	42
Other LED indicators	42
LED Indicator Sequences for the LAN Sensor	43
Other LED indicators	44
Firmware Upgrade	44
<b>2 General Operating Information</b>	
Using the 2050/60 X-Series with the Keysight BenchVue	46
Quick start example to perform an average power measurement	47
Quick start example to set up a measurement in the Trace view	51
Quick overview of the BenchVue Power Meter	55
Power meter settings in the Average only mode	58
Power meter settings in the Normal mode	60
Instrument Setup tab	63
Overview of Multiple Power Sensor Operation	65

Single bench operation .....	65
Multiple bench operation .....	68
Exploring the 2050/60 X-Series Web Interface .....	69
Launching the web interface .....	69
Navigation Bar .....	69
Displaying the Instrument control page .....	70

### 3 Characteristics and Specifications

#### A Appendix

Simplified Measurement Path .....	82
Typical Averaged Readings .....	83
Bandwidth Filter Shapes .....	85
Measurement Gates .....	86
Limit Checking Application Example .....	87



## List of Figures

Figure 1-1	USB sensor	16
Figure 1-2	LAN sensor	17
Figure 1-3	2050/60 X-Series sensor block diagram	18
Figure 1-4	Connect the U2053XA/63XA sensor to the PC	22
Figure 1-5	Auto-locate a USB instrument in Keysight Connection Expert	23
Figure 1-6	Connect the LAN sensor via Dynamic IP	24
Figure 1-7	Set automatic LAN settings on the PC	25
Figure 1-8	Add a LAN instrument in Keysight Connection Expert via host name	26
Figure 1-9	Auto-locate a LAN instrument in Keysight Connection Expert via Dynamic IP	27
Figure 1-10	Connect the LAN sensor via Auto IP	28
Figure 1-11	Set automatic LAN settings on the PC	28
Figure 1-12	Auto-locate a LAN instrument in Keysight Connection Expert	29
Figure 1-13	Connect the LAN sensor via Static IP	30
Figure 1-14	Set automatic LAN settings on the PC	31
Figure 1-15	Auto-locate a LAN instrument in Keysight Connection Expert	31
Figure 1-16	Modify and renew LAN configuration settings	32
Figure 1-17	Set manual LAN settings on the PC	33
Figure 1-18	Auto-locate a LAN instrument in Keysight Connection Expert via Static IP	34
Figure 1-19	Start instrument web interface	35
Figure 1-20	LAN sensor web-based interface (Welcome page)	36
Figure 1-21	View and modify configuration	36
Figure 1-22	View and modify LAN configuration settings	37
Figure 1-23	Modify configuration	37
Figure 1-24	Enter default password	38
Figure 1-25	Modify and renew LAN configuration settings	38
Figure 1-26	L2065XT/66XT/67XT mounting dimensions	39
Figure 2-1	Launch the Keysight BenchVue	46
Figure 2-2	Accessing the BenchVue Power Meter help documentation	46
Figure 2-3	Performing calibration and zeroing	47
Figure 2-4	Setting the frequency	47
Figure 2-5	Average power meter measurement results	48
Figure 2-6	Creating Datalog display view	48

Figure 2-7	Selecting one of the measurements	49
Figure 2-8	Data preview bar	49
Figure 2-9	Placing a marker on the chart	50
Figure 2-10	Creating a trace	51
Figure 2-11	Performing calibration and zeroing	51
Figure 2-12	Setting the frequency	52
Figure 2-13	Setting the trace scales	52
Figure 2-14	Adding marker or configuring the trace using Tools Palette controls	53
Figure 2-15	Setting the gates through Instrument Setup tab	53
Figure 2-16	Viewing the power measurement results of the pulse	54
Figure 2-17	Common measurement settings pane	55
Figure 2-18	Datalog settings pane	56
Figure 2-19	Export the data log file	56
Figure 2-20	Save/load the instrument state	56
Figure 2-21	Instrument setup (advanced settings) pane	57
Figure 2-22	Power meter settings in the Average only mode	58
Figure 2-23	Power meter settings in the Normal mode	60
Figure 2-24	Instrument Setup tab	63
Figure 2-25	Multiple Digital Meter display example	65
Figure 2-26	Multi-list display example	66
Figure 2-27	Multi-trace example	67
Figure 2-28	Multiple bench display example	68
Figure 2-29	2050/60 X-Series Web Interface's Welcome Window	69
Figure 2-30	Navigation bar	70
Figure 2-31	Password Panel	70
Figure 2-32	Instrument control panel	71
Figure 2-33	Measurement Relative setting	72
Figure 2-34	Operation and Feed Setting	73
Figure 2-35	Channel Setup -Normal Mode	74
Figure 2-36	Channel Setup - Average Mode	75
Figure 2-37	Calibration Panel	75
Figure 2-38	System panel	76
Figure 2-39	System Panel - Presets and Reset	76
Figure 2-40	Digital Meter Display	77
Figure 2-41	Footer	77
Figure 2-42	System error	77

# List of Tables

Table 1-1	Other LED indicators for the USB sensor	42
Table 1-2	Other LED indicators for the LAN sensor	44
Table 2-1	Power meter settings in the Average only mode description	59
Table 2-2	Power meter settings in Normal mode description	61
Table 2-3	Additional Instrument Setup tab settings description	64
Table A-1	Range of values for limits	87

THIS PAGE HAS BEEN INTENTIONALLY LEFT BLANK.

Keysight 2050/60 X-Series  
Wide Dynamic Range Power Sensors  
User's Guide

# 1 Getting Started

Overview	14
Theory of Operation	18
Standard shipped items	20
Hardware Installation and Configuration	22
Connect the USB sensor	22
Connect the LAN sensor	24
LED Indicator Sequence During Power-Up for the USB Sensor	42
LED Indicator Sequence During Power-Up for the LAN Sensor	42
Other LED indicators	42
LED Indicator Sequences for the LAN Sensor	43
Other LED indicators	44
Firmware Upgrade	44

This chapter gets you started with the 2050/60 X-Series wide dynamic range power sensors.

# Overview

The 2050/60 X-Series wide dynamic range power sensors consist of 12 USB models and 13 LAN models:

- U2051XA USB average power sensor (10 MHz - 6 GHz)
- U2052XA USB average power sensor (10 MHz - 18 GHz)
- U2053XA USB average power sensor (10 MHz to 33 GHz)
- U2054XA USB average power sensor (10 MHz to 40 GHz)
- U2055XA USB average power sensor (10 MHz to 50 GHz)
- U2055XA option 053 USB average power sensor (10 MHz to 53 GHz)
- U2056XA USB average power sensor (10 MHz to 54 GHz)
- U2057XA USB average power sensor (10 MHz to 67 GHz)
- U2061XA USB peak and average power sensor (10 MHz - 6 GHz)
- U2062XA USB peak and average power sensor (10 MHz - 18 GHz)
- U2063XA USB peak and average power sensor (10 MHz to 33 GHz)
- U2064XA USB peak and average power sensor (10 MHz to 40 GHz)
- U2065XA USB peak and average power sensor (10 MHz to 50 GHz)
- U2065XA option 053 peak and average power sensor (10 MHz to 53 GHz)
- U2066XA USB peak and average power sensor (10 MHz to 54 GHz)
- U2067XA USB peak and average power sensor (10 MHz to 67 GHz)
- L2051XA LAN average power sensor (10 MHz to 6 GHz)
- L2052XA LAN average power sensor (10 MHz to 18 GHz)
- L2053XA LAN average power sensor (10 MHz to 33 GHz)
- L2054XA LAN average power sensor (10 MHz to 40 GHz)
- L2055XA LAN average power sensor (10 MHz to 50 GHz)
- L2055XA option 053 LAN average power sensor (10 MHz to 53 GHz)
- L2056XA LAN average power sensor (10 MHz to 54 GHz)
- L2057XA LAN average power sensor (10 MHz to 67 GHz)
- L2061XA LAN peak and average power sensor (10 MHz to 6 GHz)
- L2062XA LAN peak and average power sensor (10 MHz to 18 GHz)
- L2063XA LAN peak and average power sensor (10 MHz to 33 GHz)
- L2064XA LAN peak and average power sensor (10 MHz to 40 GHz)
- L2065XA LAN peak and average power sensor (10 MHz to 50 GHz)

- L2065XA option 053 LAN peak and average power sensor (10 MHz to 53 GHz)
- L2065XT TVAC LAN peak and average power sensor (10 MHz to 53 GHz)
- L2066XA LAN peak and average power sensor (10 MHz to 54 GHz)
- L2066XT TVAC LAN peak and average power sensor (10 MHz to 54 GHz)
- L2067XA LAN peak and average power sensor (10 MHz to 67 GHz)
- L2067XT TVAC LAN peak and average power sensor (10 MHz to 67 GHz)

The 2050/60 X-Series is capable of measuring the average and peak power of modulated, pulsed, and continuous wave (CW) signals in 10 MHz to 67 GHz frequency range and -70 dBm to 26 dBm power range.

The L2050/60 Series LAN power sensor is capable of long distance remote monitoring of up to 100 meters via the Power over Ethernet (PoE)/LAN connectivity. The PoE connectivity is compliant to the IEEE 3 W, 802.3af or 802.3at Type 1 standard.

**NOTE**

The typical LAN port on your PC or Keysight instruments is not able to power up the L2050/60 Series LAN power sensor. The L2050/60 Series LAN power sensor must be connected to a PoE port, which supplies the DC power required to power up the L2050/60 Series LAN power sensor and to transfer data.

---

**NOTE**

The L2065XT/66XT/67XT is a thermal vacuum sensor for use within a thermal vacuum (TVAC) chamber.

---

**NOTE**

As the L2065XT/66XT/67XT is fully enclosed in metal, it is strongly recommended to mount it on a cooling plate (with the thermal interface material provided) during operation to avoid overheating. Refer to **“Mount the L2065XT/66XT/67XT”** on page 39 for more information.

---

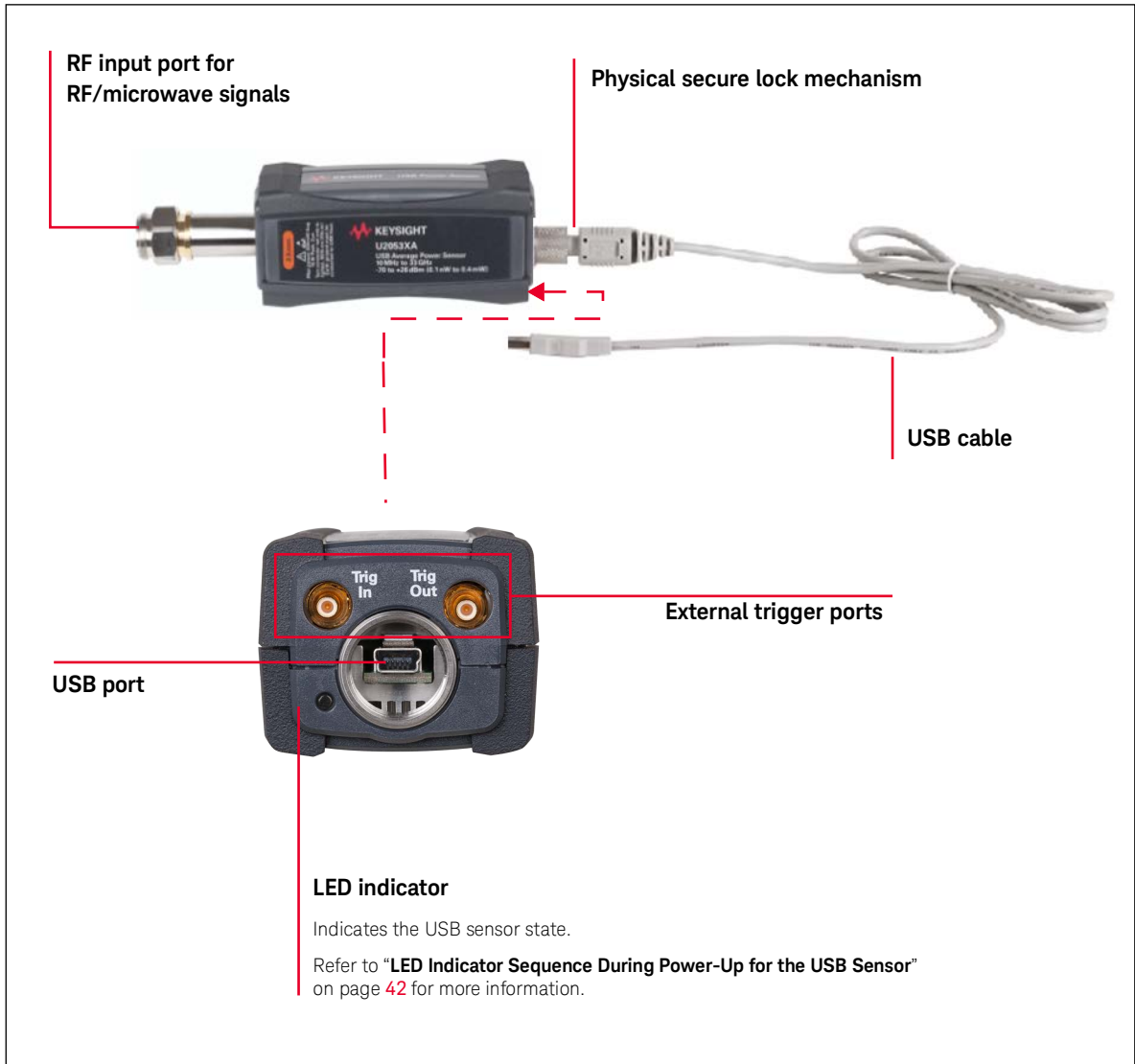


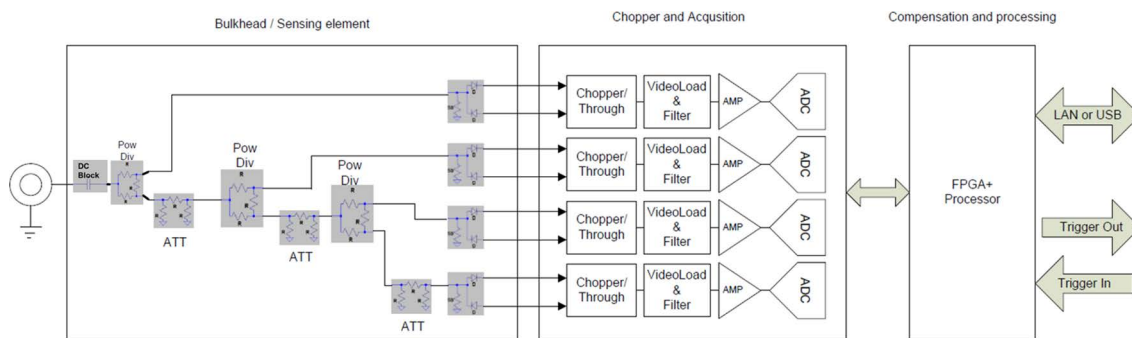
Figure 1-1 USB sensor





Figure 1-2 LAN sensor

## Theory of Operation



**Figure 1-3** 2050/60 X-Series sensor block diagram

The 2050/60 X-Series sensors utilize 4 planer doped barrier diode in a 4-path microwave circuit that enables fast average power measurements over a wide dynamic range. The 4-path network splits the input signal into a different power range for each of the 4 diodes such that all of them can operate in their square-law region. Ensuring diode power sensors operate within the square-law region means that they can convert RF power to voltage in a linear manner, regardless of the signal being measured. A single diode sensor square-law behavior may only provide perhaps 40dB of fast dynamic range. Each of the diodes has their own signal conditioning and analog to digital converter which allow subsequent digital processing to select the best diode for further processing. This in turn presents a user experience indistinguishable from a single high dynamic range square-law power sensor.

As a truly universal power sensor, it has features that allow different kinds of power measurements to be made. Primarily it operates as an average power sensor and traditionally this type of measurement means that an instrument will output a numeric result at some rate determined by the instrument. In AVERAGE mode the sensor enables a chopper amplifier circuit that allows low level signals to be measured in the presence of low frequency noise. This chopper circuit operates by modulating the signal prior to amplification; the modulation takes the form of passing or negating the signal for half-periods of the chopper signal. Recovering the original signal within the digital processing is achieved by averaging the ‘passing’ half-period samples together with the negated ‘negating’ half-period samples, to provide a new answer once for each period of the chopper. The corresponding “de-chopping” is carried out in digital section to allow proper correction and measurement of input signal. The chopper stabilization circuit essentially remove the offset and low frequency noise contribution of the signal condition stages from affecting input signal. In this series of sensor, the chopper concept is extended to allow the user to set an ‘aperture’ over which averaging is calculated. This aperture is selectable in 100ns resolution and provides a powerful mechanism for precisely tuning the instrument to the signal being measured. In addition to allowing the aperture to match a particular epoch

of the RF signal, for example setting the aperture equal to a multiple of the modulation frequency in an AM signal, there is the ability to precisely trigger the occurrence of each measurement. This allows synchronization between the device under test and the measurement system.

Sometimes it is necessary to examine the time varying characteristics of the power envelope. This allows measurements of pulse duration time or pulse period for example. This series of sensor has NORMAL measurement mode to provide 20MHz sampling of the power envelope. In common with AVERAGE mode, the best diode from the 4 ranges is selected transparently within the digital processing. In contrast to AVERAGE mode, no chopper switching is performed and the signal path is a direct coupled differential amplifier. The analog signal conditioning allows the load resistor and the low pass filter characteristics to be adjusted. Changing the load resistor also changes the response level (V/W) of the diode detector and its video bandwidth. Changing the load capacitance will affect the bandwidth but not the response level. Used together, these controls enable reduced noise on the measurement for low level signals at the expense of video bandwidth.

A high speed trigger Input and trigger output are also present in each sensor to allow proper synchronization between test instruments. Besides that, Average and Normal mode do support internal level trigger mode on top of external trigger mode. This allows flexibility in triggering on different input signal over a wide dynamic range.

A high speed acquisition and processing engine is also present in the sensor to enable a complex calibration scheme to track the performance of various modes across frequency, input power and temperature. The robust back end system also allows 2050/60 X-Series to be paired with either conventional USB or LAN based interface. With a LAN based interface, the prefix "U" is replaced with "L".

On top of that, the L2065XT/66XT/67XT sensor is also designed to be thermal vacuum compliant (TVAC) by controlling the outgas property of the components being used.

## Initial Inspection

When you receive your 2050/60 X-Series sensor, inspect the shipping container for damages. If the shipping container or packaging material is damaged, it should be kept until the contents of the shipment have been checked mechanically and electrically. If there is any mechanical damage, notify the nearest Keysight Sales and Service Office. Keep the damaged shipping materials (if any) for inspection by the carrier and a Keysight representative.

### Standard shipped items

Verify that you have received the following items. If anything is missing or damaged, please contact the nearest Keysight Sales Office.

#### USB power sensor:



**LAN power sensor:**

LAN power sensor



Trigger cable, BNC male to SMB female, 50 W, 1.5 m (Quantity: 2)



Shielded LAN cable 5 ft (1.5 m), default cable length

**Certificate of calibration**

Certificate of calibration

# Hardware Installation and Configuration

**NOTE**

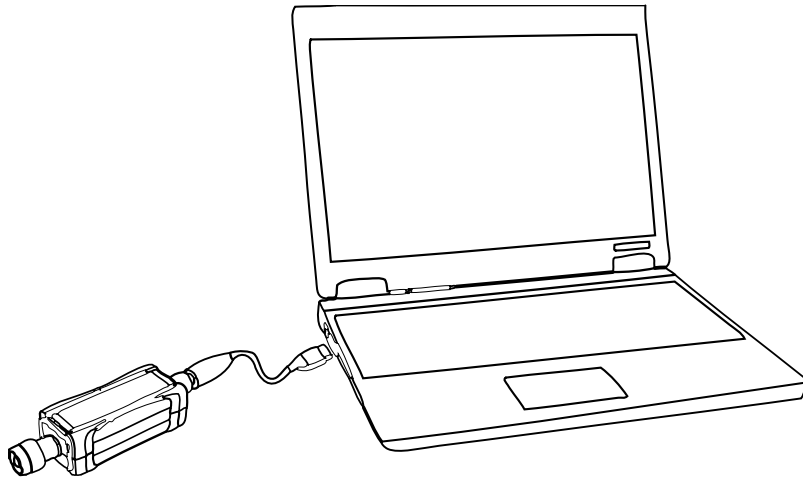
For power measurements of  $< -60$  dBm, it is recommended to turn on the 2050/60 X-Series for 1.5 hours (with the 2050/60 X-Series connected to the device-under-test).

Prior to using the 2050/60 X-Series, ensure that the following minimum requirements are met:

- PC with USB and LAN host capability
- Keysight IO Libraries Suite 17.0 or higher installed
- Keysight BenchVue installed

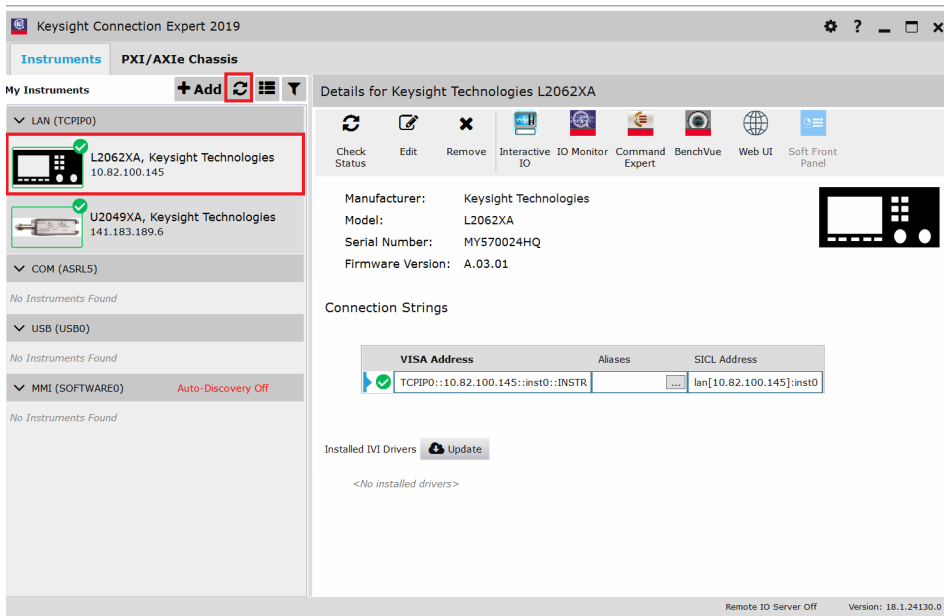
## Connect the USB sensor

- 1 Connect the power sensor to the PC. The sensor driver is detected and installed automatically.



**Figure 1-4** Connect the U2053XA/63XA sensor to the PC

- 2 Go to **Start > All Programs > IO Control** (  ) to launch Keysight Connection Expert application. Click **Start a Scan for connected instruments** to auto-locate the sensor as shown in **Figure 1-5**.



**Figure 1-5** Auto-locate a USB instrument in Keysight Connection Expert

- 3** Click **Interactive IO** to verify the sensor is connected.
- 4** When the sensor is connected, go to **Chapter 2**, "Using the 2050/60 X-Series with the Keysight BenchVue" to launch the BenchVue Power Meter application, or proceed to operate the sensor via remote programming.

## Operating the sensor remotely using SCPI commands

You can send SCPI commands to operate the sensor. Refer to the *2050/60 X-Series Programming Guide* for details.

## Connect the LAN sensor

Connect the LAN sensor via any of the following LAN operating modes:

- Dynamic IP (Dynamic Host Configuration Protocol or DHCP)
- Auto IP (Local PC control or isolated (non-site) LAN)
- Static IP (Manual mode)

The default LAN operating mode of the LAN sensor is Dynamic IP.

Dynamic IP and Auto IP are enabled on the LAN sensor shipped from Keysight. This allows the LAN sensor to automatically obtain an address on the network.

The LAN sensor communicates with the DHCP server to obtain the LAN interface configuration. If the DHCP server is not detected, then either the DHCP server is not present or it does not allow the LAN sensor to obtain an IP address. The LAN sensor will then try to obtain the LAN configuration using AutoIP if enabled, otherwise the LAN sensor will try to use the static IP set in the LAN sensor. If required, push the LAN reset switch to reset the LAN sensor LAN configuration to a known default state.

### NOTE

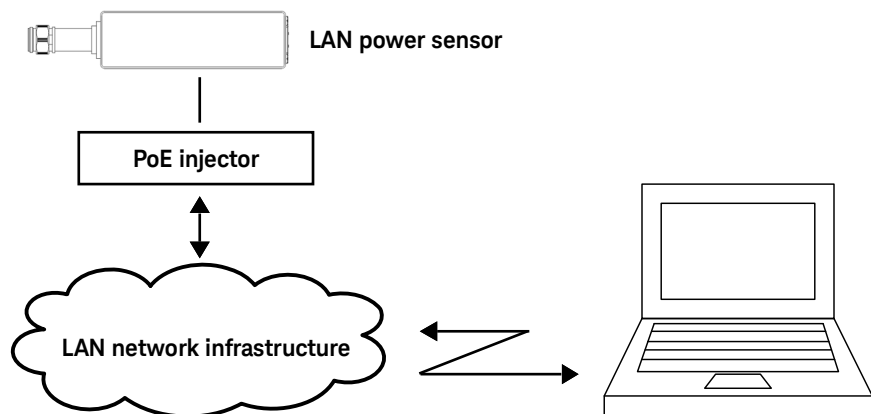
The LED indicator will turn red indicating the following error when the DHCP server is not detected:

-310, "System error;The sensor could not obtain a LAN configuration using DHCP. The sensor will try to obtain IP address using AutoIP if enabled".

For more information on LAN instrument connectivity, refer to the *Keysight IO Libraries Suite Connectivity Guide*.

## Dynamic IP mode

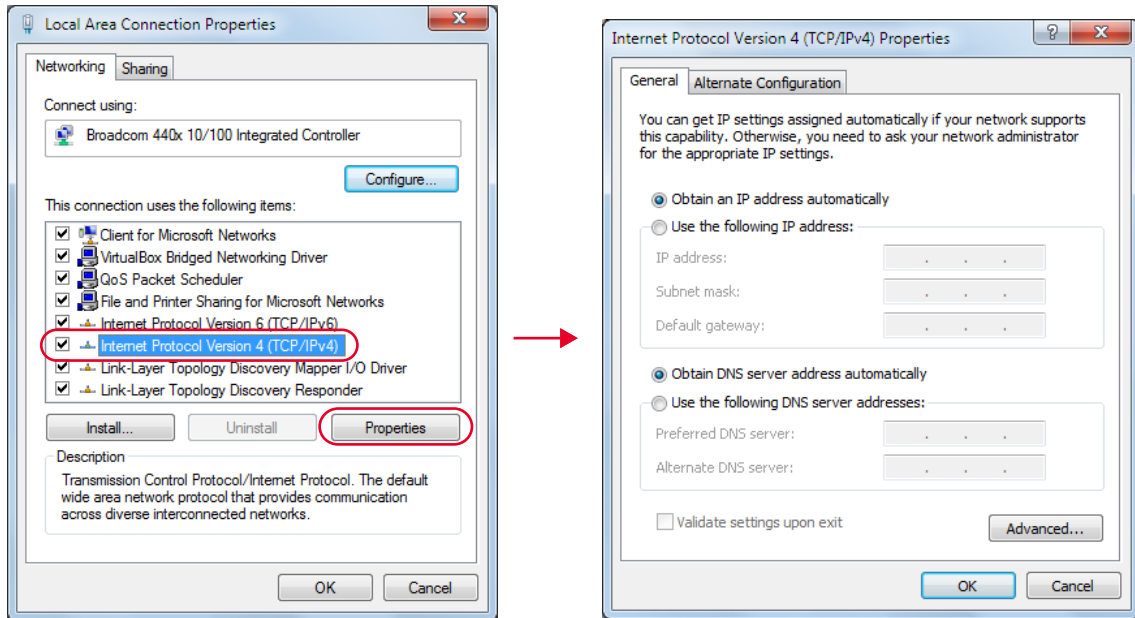
In this mode, the IP address, subnet mask, and default gateway values are obtained from a DHCP server.




**Figure 1-6** Connect the LAN sensor via Dynamic IP



- 1 Set up the connection as shown in **Figure 1-6**.
- 2 On your PC, set the LAN settings to the automatic configuration. Go to **Start > Control Panel > Network and Internet > Network and Sharing Center > Local Area Connection > Properties** and set the following properties.



**Figure 1-7** Set automatic LAN settings on the PC

- 3 Go to **Start > All Programs > IO Control** (  ) to launch Keysight Connection Expert application.
- 4 Select **Add > LAN instrument**.  
The **Add a LAN device** window is displayed.
- 5 Enter the instrument host name (**Figure 1-8**) in the **Hostname or IP Address** field. Every LAN sensor has a default host name in the form of:  
**K- + product model+ - + suffix five digits of the serial number**  
Example:  
**K-L2051XA-XXXXX**

**Add a LAN device** [X]

**Select from List** | **Enter Address**

Set LAN Address:

Hostname or IP Address:

TCPIP Interface ID:

Set Protocol:

Instrument (VXI-11)      Remote Name:

HiSlip                      Remote Name:

Socket                        Port Number:

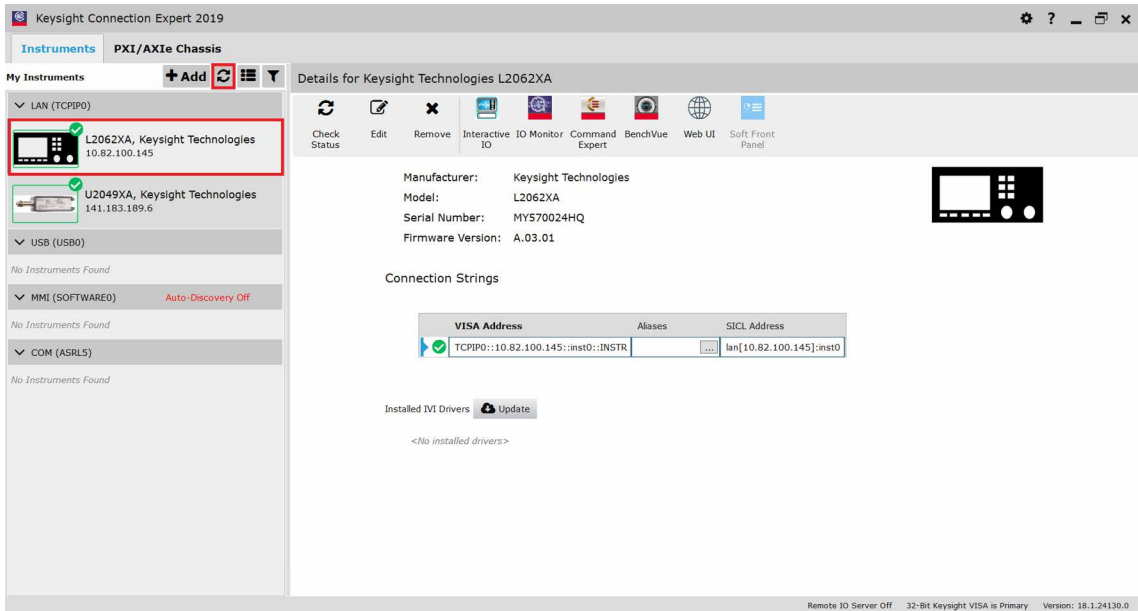
Verify Connection:

Allow \*IDN Query

View Web Page:

**Figure 1-8** Add a LAN instrument in Keysight Connection Expert via host name

- 6** Select **Allow \*IDN Query** and click **Test This VISA Address** to verify the LAN sensor is connected. Once verified, click **Accept**.
- 7** Alternatively, click **Start a Scan for connected instruments** to auto-locate the sensor as shown in **Figure 1-9**.

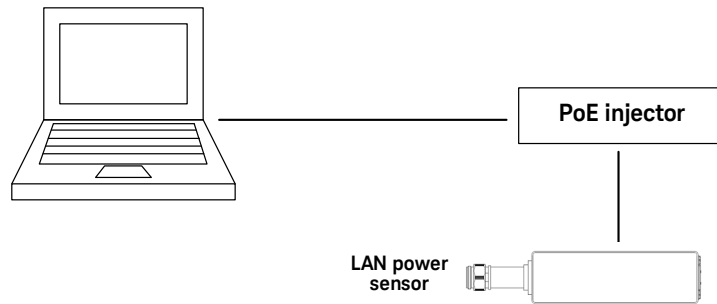


**Figure 1-9** Auto-locate a LAN instrument in Keysight Connection Expert via Dynamic IP

- 8** Click **Interactive IO** to verify the LAN sensor is connected.
- 9** When the LAN sensor is connected, go to **Chapter 2**, "Using the 2050/60 X-Series with the Keysight BenchVue" to launch the BenchVue, or proceed to operate the LAN sensor via remote programming.

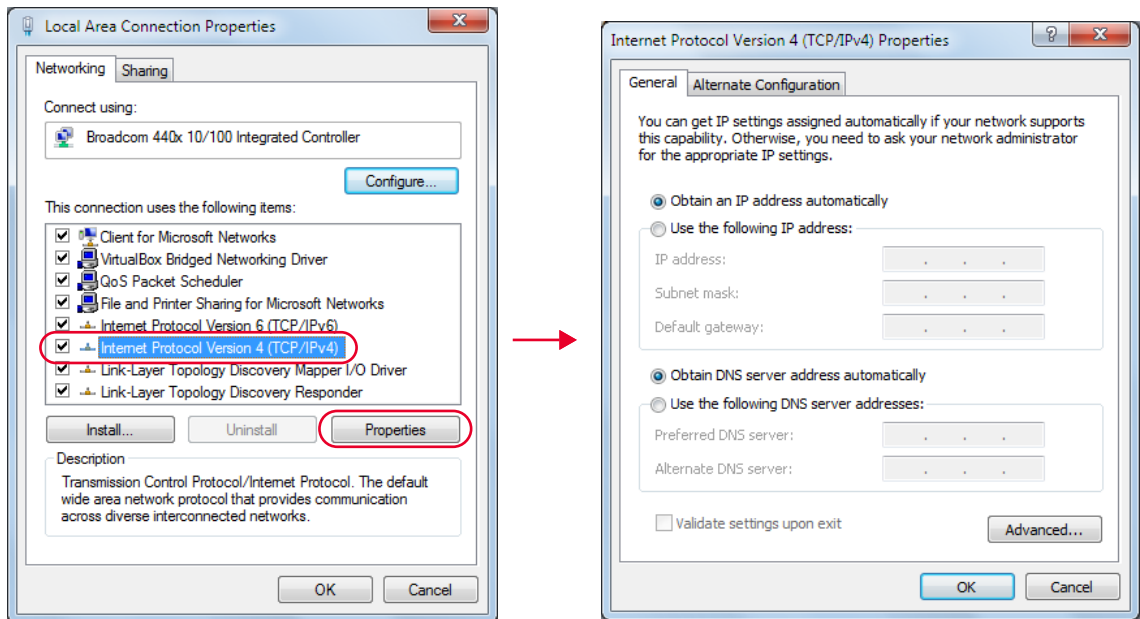
## Auto IP mode

Use this procedure if you require local PC control or you are working in a private (non-site) LAN environment.



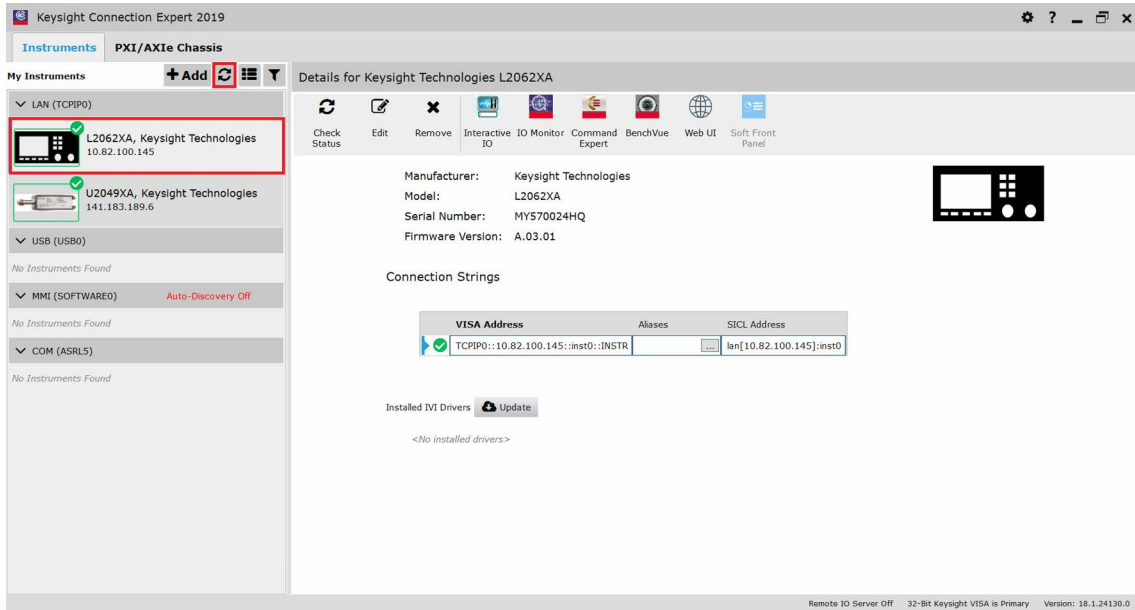
**Figure 1-10** Connect the LAN sensor via Auto IP

- 1 Set up the connection as shown above.
- 2 On your PC, set the LAN settings to the automatic configuration. Go to **Start > Control Panel > Network and Internet > Network and Sharing Center > Local Area Connection > Properties** and set the following properties.



**Figure 1-11** Set automatic LAN settings on the PC

- Go to **Start > All Programs > IO Control** (  ) to launch Keysight Connection Expert application. Click **Start a Scan for connected instruments** to auto-locate the sensor as shown in the figure below.



**Figure 1-12** Auto-locate a LAN instrument in Keysight Connection Expert

- Click **Interactive IO** to verify the LAN sensor is connected.
- When the LAN sensor is connected, go to **Chapter 2**, "Using the 2050/60 X-Series with the Keysight BenchVue" to launch the BenchVue, or proceed to operate the LAN sensor via remote programming.

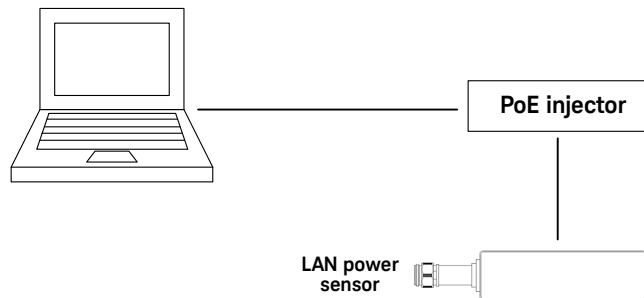
## Static IP mode (configuring the LAN manually)

In static IP mode, you must set up the IP address, subnet mask, and default gateway that are compatible with your network infrastructure (PC configuration).

Using a static IP address is useful if you always want to communicate with the instrument using the same IP address every time it is turned on.

### NOTE

After configuring LAN settings, you must first power cycle the LAN sensor. This enables the new network settings to become effective.



**Figure 1-13** Connect the LAN sensor via Static IP

- 1 Set up the connection as shown above.
- 2 On your PC, set the LAN settings to the automatic configuration. Go to **Start > Control Panel > Network and Internet > Network and Sharing Center > Local Area Connection > Properties** and set the following properties.

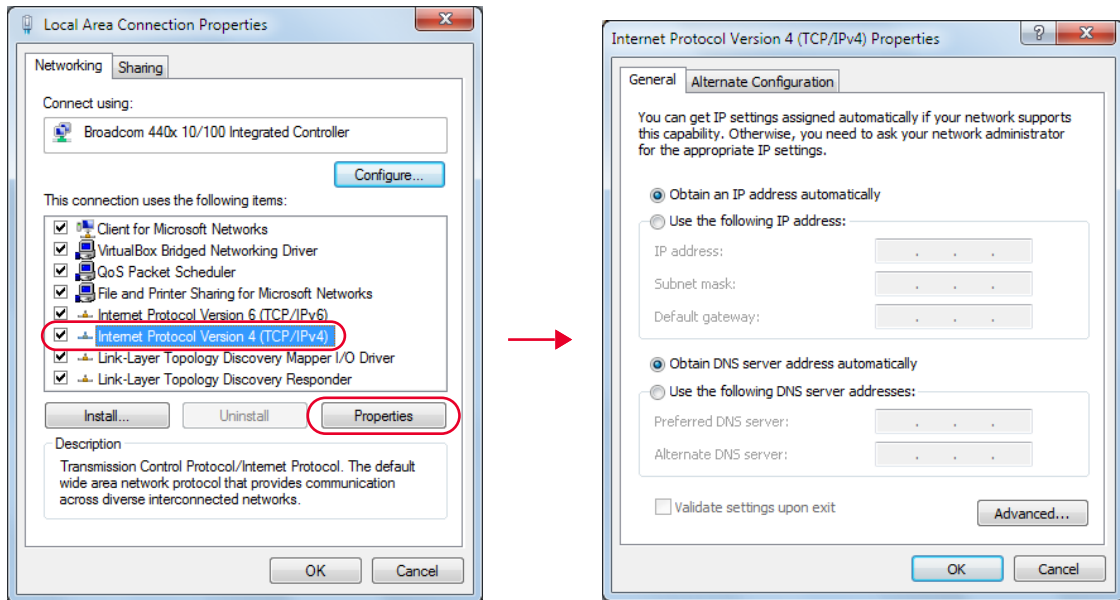


Figure 1-14 Set automatic LAN settings on the PC

- 3 Go to **Start > All Programs > IO Control** (  ) to launch Keysight Connection Expert application. Click **Start a Scan for connected instruments** to auto-locate the sensor as shown in the figure below.

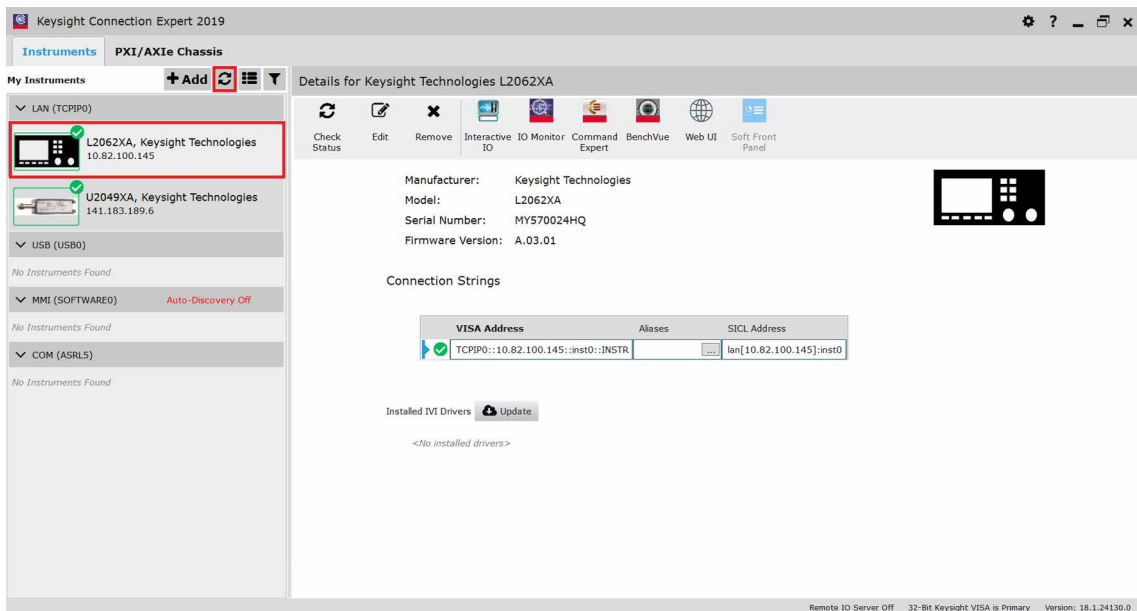


Figure 1-15 Auto-locate a LAN instrument in Keysight Connection Expert

- 4 To enable static IP, click **Interactive IO** and send the following SCPI commands:
  - SYSTEM:COMMunicate:LAN:DHCP[:STATE] 0 //Turns off Dynamic IP
  - SYSTEM:COMMunicate:LAN:AIP[:STATE] 0 //Turns off Auto IP
  - SYSTEM:COMMunicate:LAN:REStart //Restarts the LAN network for the above setup to take effect

**NOTE**

For more information on remote SCPI programming, refer to the *2050/60 X-Series Programming Guide*.

Alternatively, you can set these configurations using the LAN sensor web-based interface (see “**Using the Instrument Web Browser**” on page 35).

On the **Configuring your L20xxXA Power Sensor** page, set the **DHCP** and **Auto IP** buttons to **OFF**. Click **Save** to save the new settings. Then click **Renew LAN Settings** for the changes to take effect.

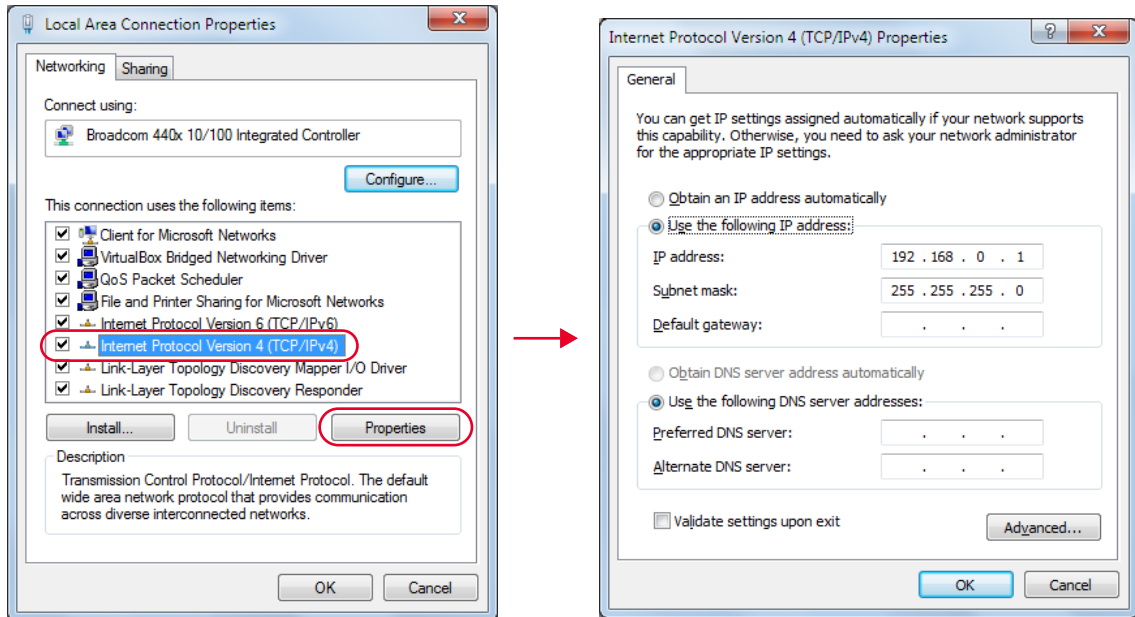
The screenshot shows the web interface for the L2065XA Power Sensor. The main configuration table is as follows:

Parameter	Configured Value	Edit Configuration
DHCP:	ON	<input checked="" type="radio"/> OFF <input type="radio"/> ON
Auto IP:	ON	<input type="radio"/> OFF <input checked="" type="radio"/> ON
Manual:	OFF	<input type="radio"/> OFF <input checked="" type="radio"/> ON
IP Address:	192.168.0.10	192.168.0.10
Subnet Mask:	255.255.0.0	255.255.0.0
Default Gateway:	0.0.0.0	0.0.0.0
Dynamic DNS:	ON	<input type="radio"/> OFF <input checked="" type="radio"/> ON
DNS Servers:	USE DHCP	<input type="radio"/> USE STATIC <input checked="" type="radio"/> USE DHCP
The following DNS Servers will be used if DHCP is OFF or unavailable, or if USE STATIC is the currently configured DNS Server setting.		
DNS Server:	0.0.0.0	0.0.0.0
DNS Server:	0.0.0.0	0.0.0.0
DNS Server:	0.0.0.0	0.0.0.0
Hostnames:	K-L2065XA-00029	K-L2065XA-00029
The following Domain Name will be used if DHCP is OFF or unavailable.		
Domain Name:		
NetBIOS:	ON	<input type="radio"/> OFF <input checked="" type="radio"/> ON
mDNS and DNS-SD:	ON	<input type="radio"/> OFF <input checked="" type="radio"/> ON
Ethernet Connection Monitoring:	ON	<input type="radio"/> OFF <input checked="" type="radio"/> ON
Description:	Keysight Power Sensor L2065XA - MY5000029	Keysight Power Sensor L2065XA... (Save blank value before restoring it to default value)
TCP Keep Alive:	ON	<input type="radio"/> OFF <input checked="" type="radio"/> ON

**Figure 1-16** Modify and renew LAN configuration settings

- 5 Set the PC IP address and subnet mask. Go to **Start > Control Panel > Network and Internet > Network and Sharing Center > Local Area Connection > Properties** and set the following properties.




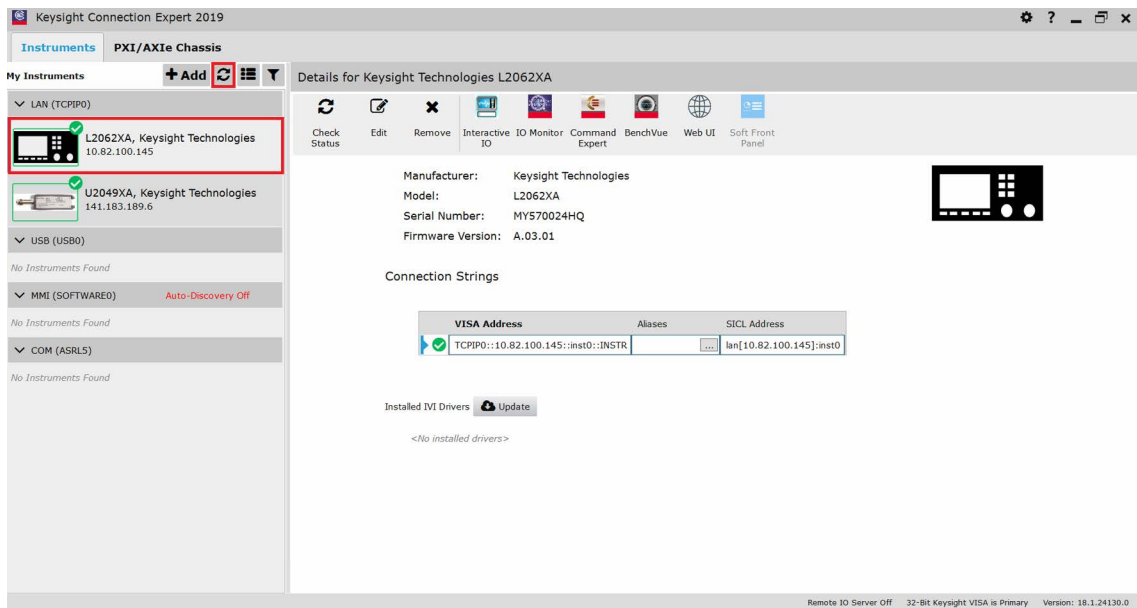


**Figure 1-17** Set manual LAN settings on the PC

## NOTE

- For the new network settings to become effective, you must first power cycle the LAN sensor.
- The static IP addresses for the host PC and the LAN sensor must be different from the IP address of the PoE injector to avoid conflict.

- 6 Go to **Start > All Programs > IO Control** (  ) to launch Keysight Connection Expert application. Click **Start a Scan for connected instruments** to auto-locate the sensor as shown in **Figure 1-18**.



**Figure 1-18** Auto-locate a LAN instrument in Keysight Connection Expert via Static IP

**7** Click **Interactive IO** to verify the LAN sensor is connected.

## NOTE

Alternatively, you can locate the LAN sensor by entering its default static IP address (*192.168.0.10*) in the **Add a LAN device (Add > LAN instrument)** window.

**8** When the LAN sensor is connected, go to **Chapter 2**, "Using the 2050/60 X-Series with the Keysight BenchVue" to launch the BenchVue, or proceed to operate the LAN sensor via remote programming.

## NOTE

To revert to the Dynamic IP mode from the static IP mode, you can either:

- send the following SCPI commands.
  - **SYSTem:COMMunicate:LAN:DHCP[:STATE] 1**
  - **SYSTem:COMMunicate:LAN:AIP[:STATE] 1**
  - **SYSTem:COMMunicate:LAN:REStart**
- configure and renew the LAN settings via the instrument web browser.

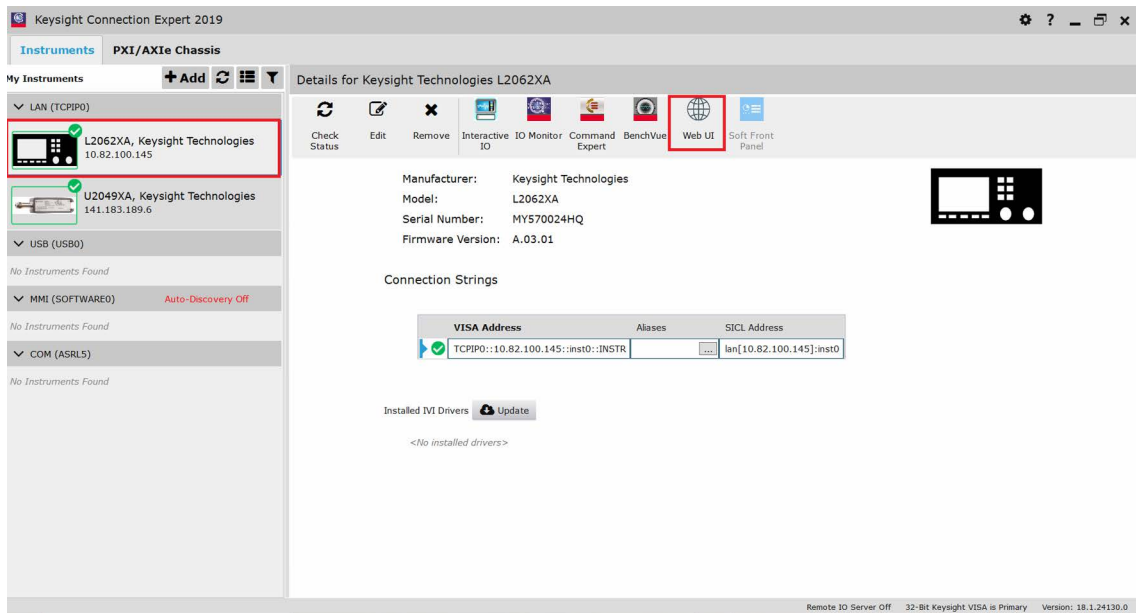
Refer to "**Dynamic IP mode**" on page **24** for the procedure. You will need to power cycle the LAN sensor for the new network settings to take effect.

## Using the Instrument Web Browser

The LAN sensor can be programmed using its web-based interface (web browser). The web browser functions as a virtual front panel which can also be used for:

- interactive IO
- familiarization with instrument capabilities
- determining/changing instrument configuration

- 1 On the Keysight Connection Expert, click **Web UI** to launch the LAN sensor web-based interface.



**Figure 1-19** Start instrument web interface

### NOTE

The web-based interface can also be opened directly from a web browser by entering the LAN sensor's IP address or hostname in the 'address' bar of the browser.

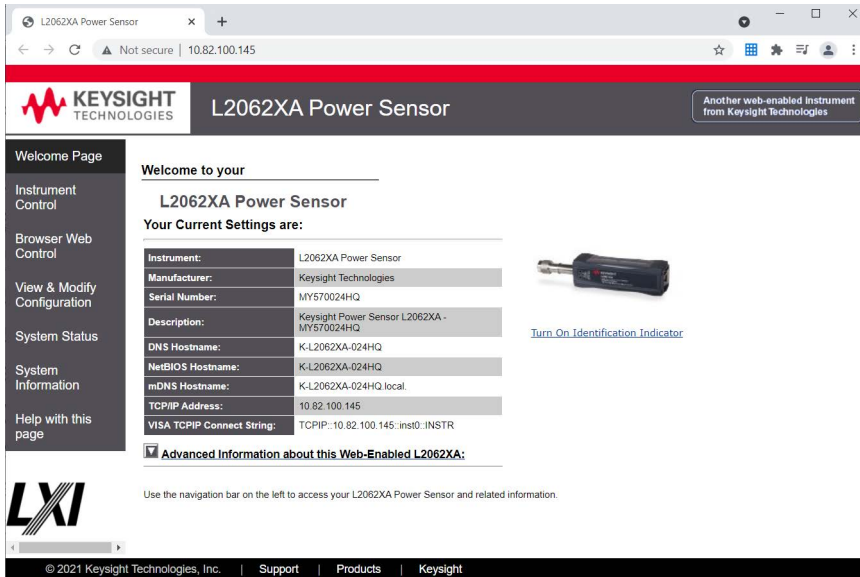


Figure 1-20 LAN sensor web-based interface (Welcome page)

2 Click **View & Modify Configuration** to access the LAN configuration settings.

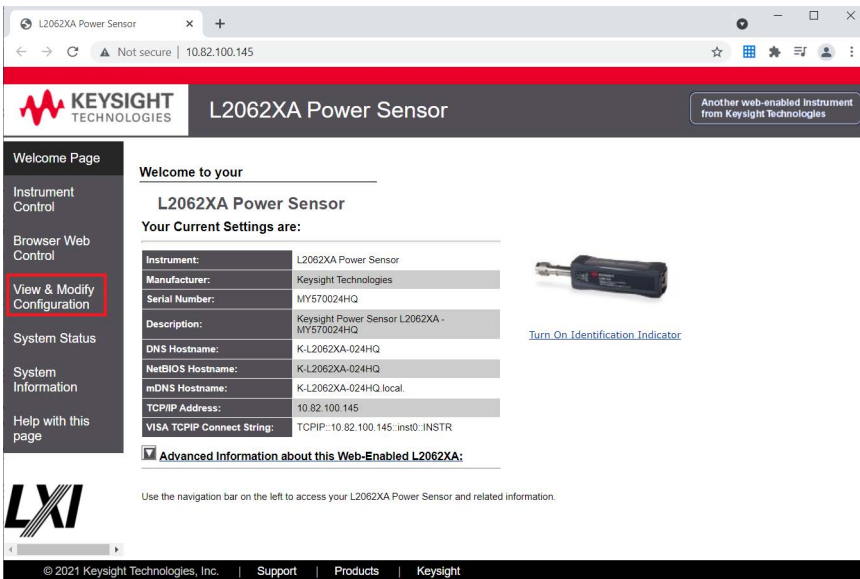


Figure 1-21 View and modify configuration

The screenshot shows a web browser window with the address bar displaying "10.82.100.145". The page title is "L2062XA Power Sensor" and it features the Keysight Technologies logo. A navigation sidebar on the left includes options like "Welcome Page", "Instrument Control", "Browser Web Control", "View & Modify Configuration", "System Status", "System Information", and "Help with this page". The main content area is titled "Current Configuration of L2062XA Power Sensor" and contains a "Modify Configuration" button above a table of settings.

Parameter	Currently in use
IP Address:	10.82.100.145
Subnet Mask:	255.255.248.0
Default Gateway:	10.82.96.1
DNS Server(s):	141.183.230.30 141.183.236.41 0.0.0.0
Hostname:	K-L2062XA-024HQ
Domain:	png.is.keysight.com
NetBIOS:	ON
mDNS and DNS-SD:	ON
Ethernet Connection Monitoring:	ON
Description:	Keysight Power Sensor L2062XA - MY570024HQ
TCP Keep Alive:	ON
TCP Keep Alive Time:	7200

**Figure 1-22** View and modify LAN configuration settings

- 3 Click **Modify Configuration** to edit the LAN configuration settings.

This screenshot is similar to the previous one but highlights the "Modify Configuration" button with a red rectangle. The table below shows the current configuration settings.

Parameter	Currently in use
IP Address:	10.82.100.145
Subnet Mask:	255.255.248.0
Default Gateway:	10.82.96.1

**Figure 1-23** Modify configuration

- 4 Enter the default password "keysight".



Figure 1-24 Enter default password

- 5 On this page, you can configure and renew the LAN settings, as well as power cycle the LAN sensor or reset the LAN settings.

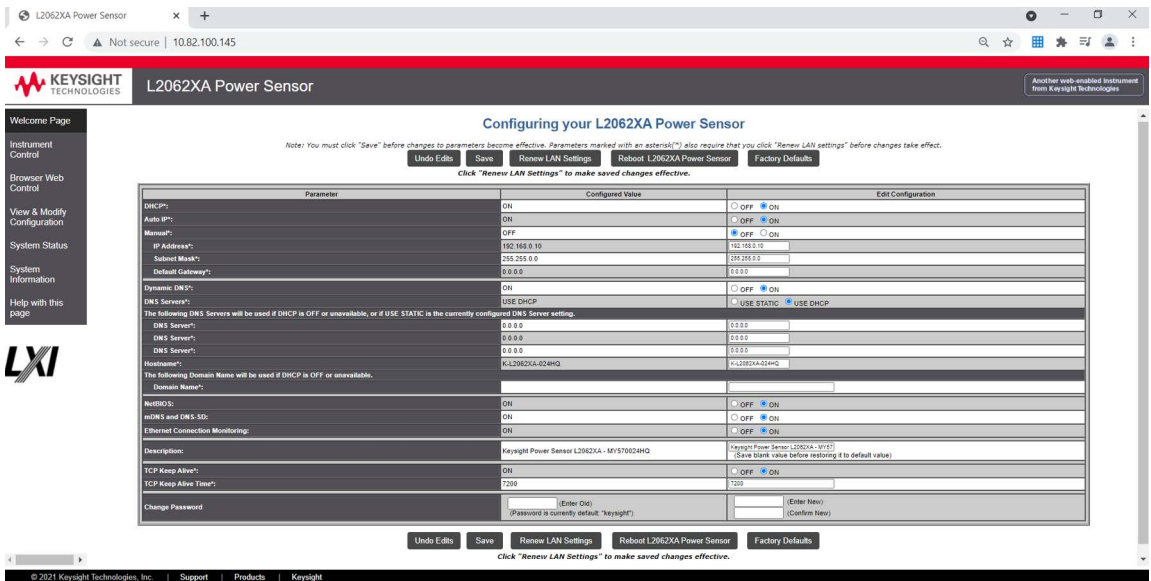


Figure 1-25 Modify and renew LAN configuration settings

**NOTE**

If you have changed the password, resetting the LAN configuration will reset the password to default as well.

## Configuring the LAN remotely using SCPI commands

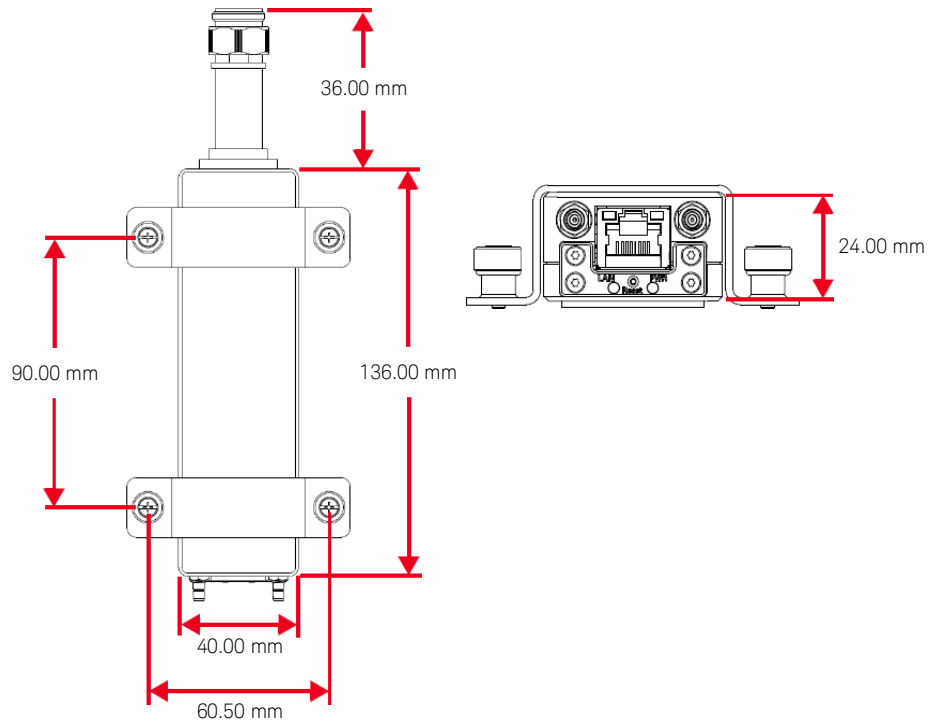
You can send SCPI commands to automatically or manually configure the LAN settings for the LAN sensor. Refer to the *2050/60 X-Series Programming Guide* for details.

## Mount the L2065XT/66XT/67XT

The L2065XT/66XT/67XT is strongly recommended to be mounted on a cooling plate for more effective heat dissipation when used in a TVAC chamber.

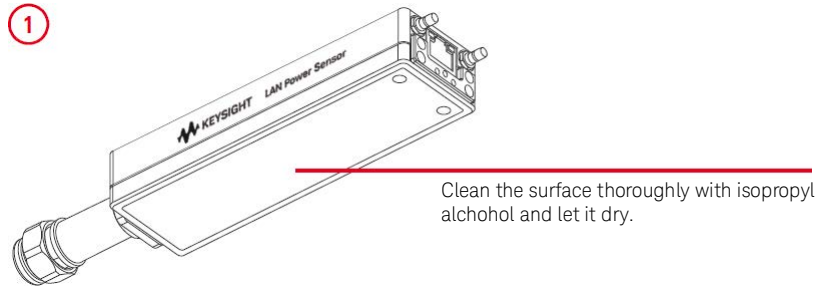
The cooling plate consists of four mounting threaded holes and the minimum thread height of each hole is 6 mm.

### Mounting dimensions

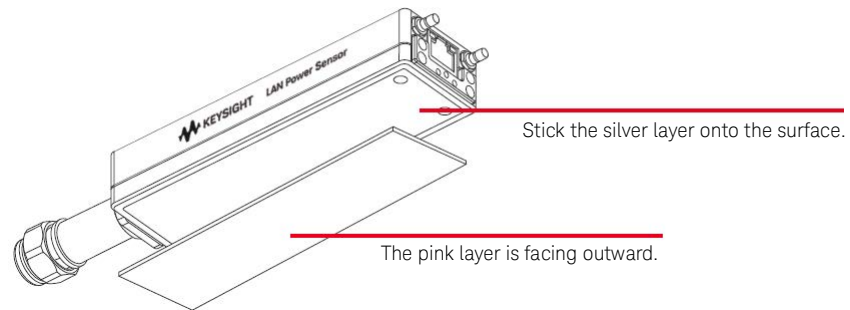


**Figure 1-26** L2065XT/66XT/67XT mounting dimensions

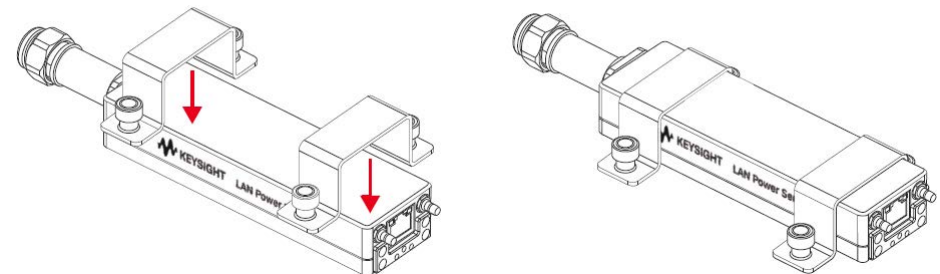
## Mounting procedure



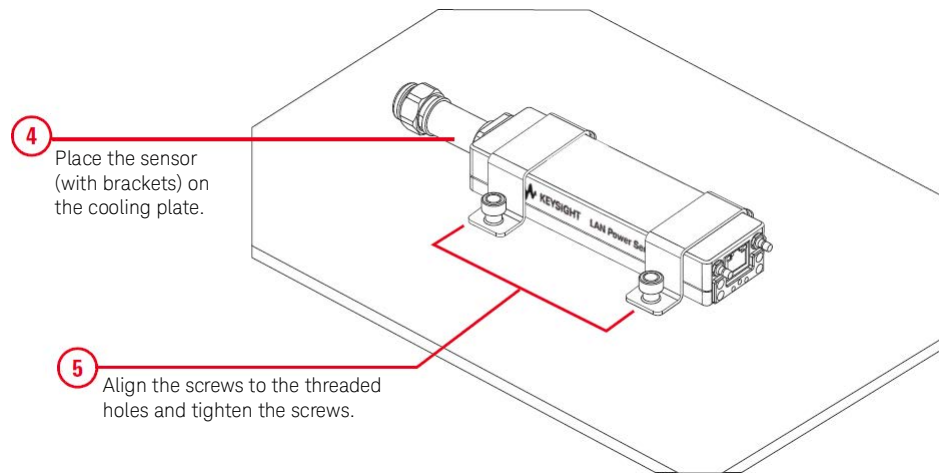
② Install the thermal interface material on to the sensor's surface.



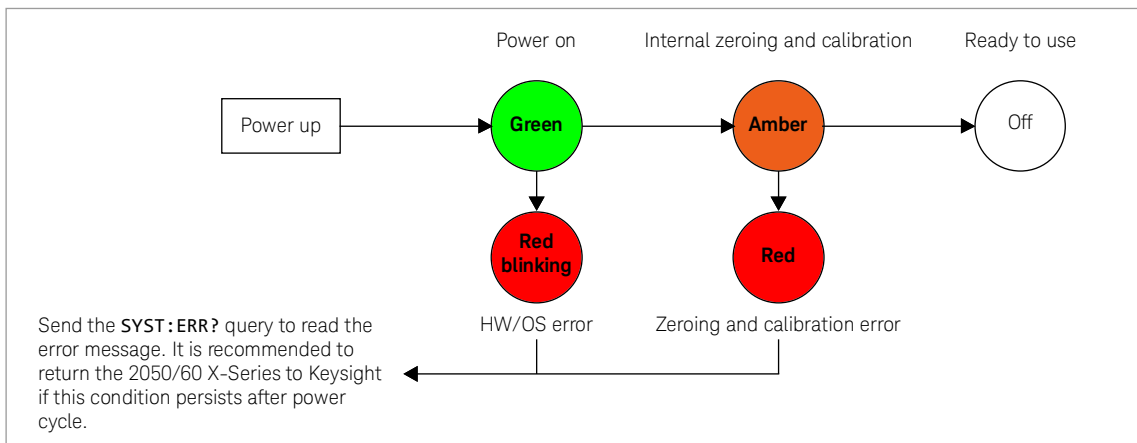
③ Briefly install the brackets.










# LED Indicator Sequence During Power-Up for the USB Sensor



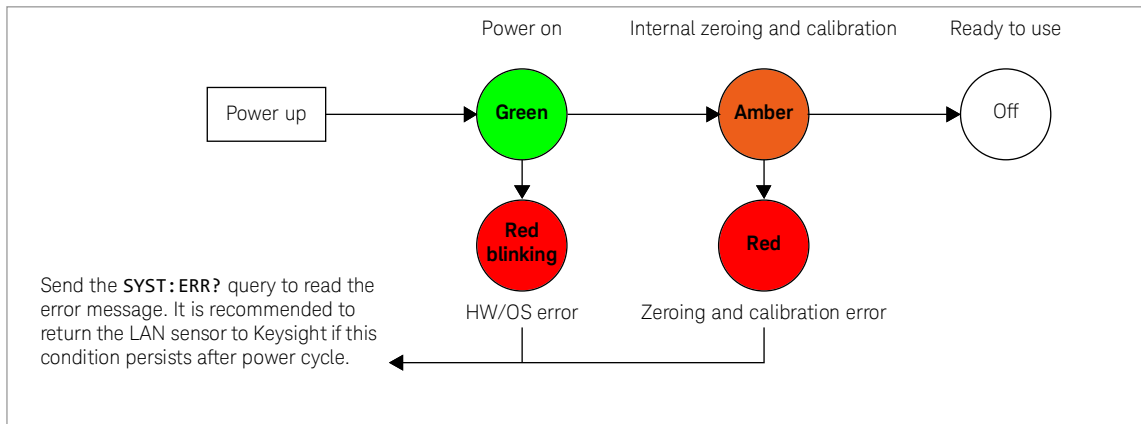
## Other LED indicators

**Table 1-1** Other LED indicators for the USB sensor

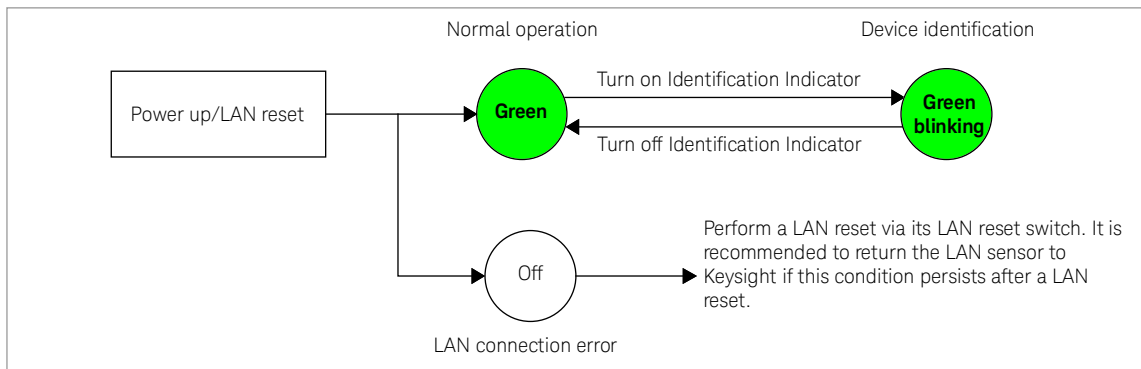
	Secure erase, flash formatting, or firmware update in progress.
	An error is present in the SCPI error queue including input overload. If the error queue is cleared (via the <code>*CLS</code> command) or the last error is read from the queue (via the <code>SYST:ERR?</code> query), the indicator will turn off.
	USB activity in progress.

# LED Indicator Sequences for the LAN Sensor

## During power-up (via PWR LED indicator)





## For LAN activity (via LAN LED indicator)



## Other LED indicators

**Table 1-2** Other LED indicators for the LAN sensor

---

	Secure erase, flash formatting, or firmware update in progress.
	An error is present in the SCPI error queue including input overload. If the error queue is cleared (via the *CLS command) or the last error is read from the queue (via the SYST:ERR? query), the indicator will turn off.

---

## Firmware Upgrade

To download the latest firmware version for the 2050/60 X-Series, go to [www.keysight.com/find/pm\\_firmware](http://www.keysight.com/find/pm_firmware). The latest firmware includes the executable file and help file for installing the Firmware Upgrade Utility application in order to upgrade the 2050/60 X-Series.

Keysight 2050/60 X-Series  
Wide Dynamic Range Power Sensors  
User's Guide

## 2 General Operating Information

Using the 2050/60 X-Series with the Keysight BenchVue	46
Quick start example to perform an average power measurement	47
Quick start example to set up a measurement in the Trace view	51
Quick overview of the BenchVue Power Meter	55
57	
Power meter settings in the Normal mode	60
Instrument Setup tab	63
Overview of Multiple Power Sensor Operation	65
Single bench operation	65
Multiple bench operation	68
Multiple bench display example	68
Exploring the 2050/60 X-Series Web Interface	69
Launching the web interface	69
Navigation Bar	69
Displaying the Instrument control page	70

This chapter describes the general operating information of the 2050/60 X-Series.

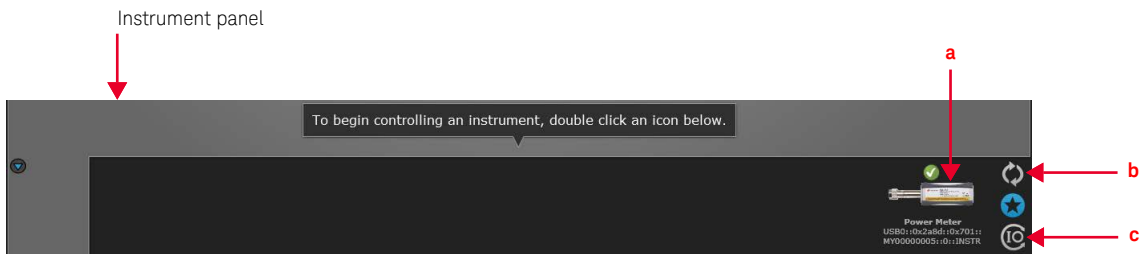
## Using the 2050/60 X-Series with the Keysight BenchVue

The BenchVue Power Meter application provides a virtual operating interface for the 2050/60 X-Series. This chapter describes the 2050/60 X-Series functions in the BenchVue Power Meter application in general.




### NOTE

For more information on how to configure each 2050/60 X-Series function or use each BenchVue Power Meter feature, refer to the Keysight BenchVue Power Meter help documentation.

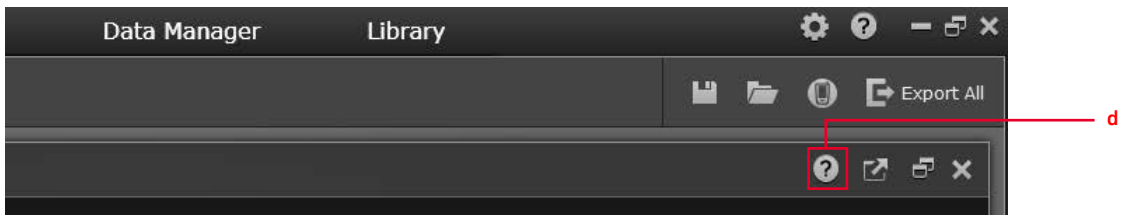
Go to **Start > All Programs > Keysight > Keysight BenchVue > Keysight BenchVue** to launch the BenchVue Power Meter application.




**Figure 2-1** Launch the Keysight BenchVue

- a** Double-click the connected sensor (  ) at the Instrument panel to start controlling the power sensor.
- b** If the sensor is found in the Keysight Connection Expert but is not shown in the BenchVue Instrument panel, select the refresh icon (  ) to refresh the instrument list.
- c** If the sensor is not found, select the IO icon (  ) to launch the Keysight Connection Expert to verify that the power sensor is connected properly.

When you launch the BenchVue Power Meter application, the Digital Meter is displayed by default.



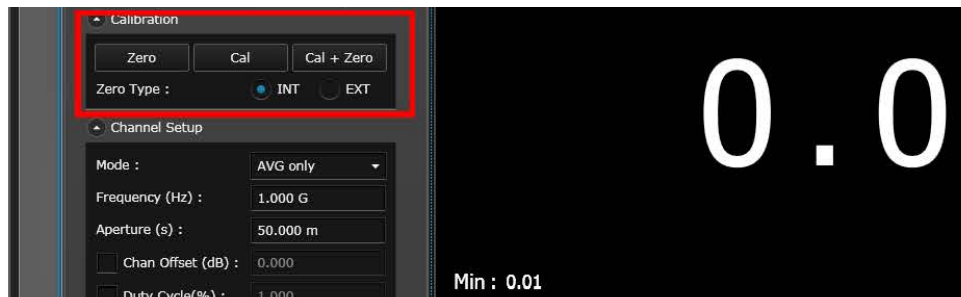
**Figure 2-2** Accessing the BenchVue Power Meter help documentation

- d Click (  ) to access the BenchVue Power Meter help documentation.

## Quick start example to perform an average power measurement

The following example guides you on how to quickly measure average power via BenchVue. It is assumed that the 2050/60 X-Series is already connected to a signal generator.

- 1 Set up the signal generator as follows:
  - Amplitude: 0 dBm
  - Frequency: 1 GHz
  - Modulation: Disabled
- 2 Turn on the RF output of the signal generator. Launch the BenchVue Power Meter application (refer to **page 46**). By default the power meter mode is already set to Average only.
- 3 Perform calibration and zeroing for an accurate measurement result.

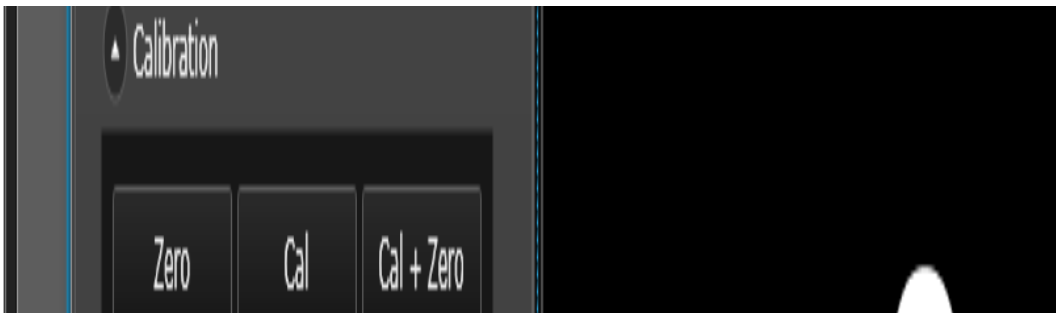


**Figure 2-3** Performing calibration and zeroing

### NOTE

For power measurements below  $-50$  dBm, it is recommended to perform external zeroing and turn off the RF output for better accuracy and repeatability.

- 4 Set the frequency of the 2050/60 X-Series to 1 GHz.






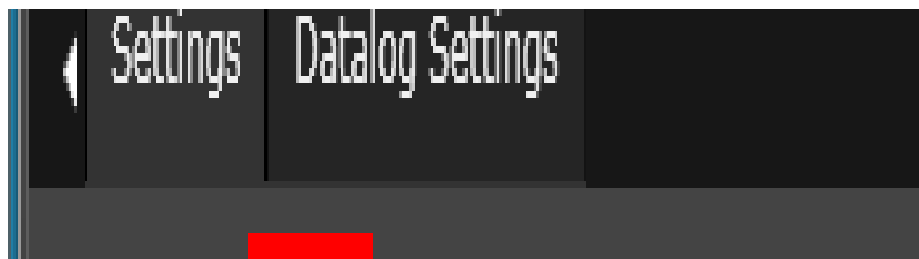
**Figure 2-4** Setting the frequency

- 5 You should be able to view the average power measurement results in the Digital Meter display view.



**Figure 2-5** Average power meter measurement results

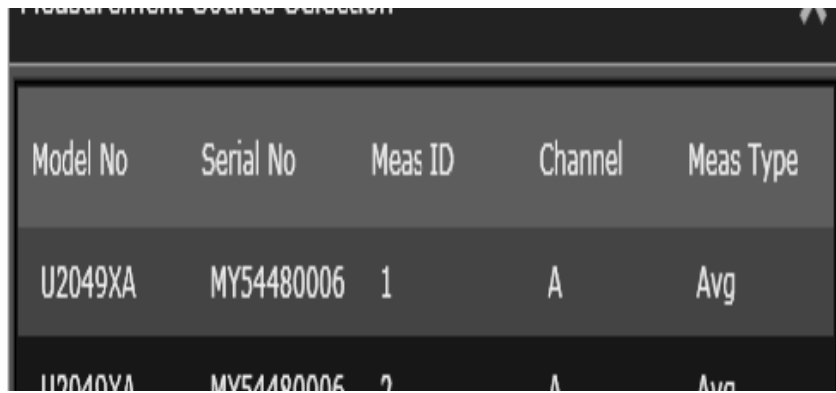
- a Indicates acquisition of measurements in the Run mode
  - b Indicates the measurement status
  - c  Change the title at the top of the display view
  -  Reset the displayed Minimum/Maximum measured values
  - d Summary of alert limit conditions for the current measurement
- 6 To monitor the average power over a period of time, create a Datalog display view by clicking .



**Figure 2-6** Creating Datalog display view

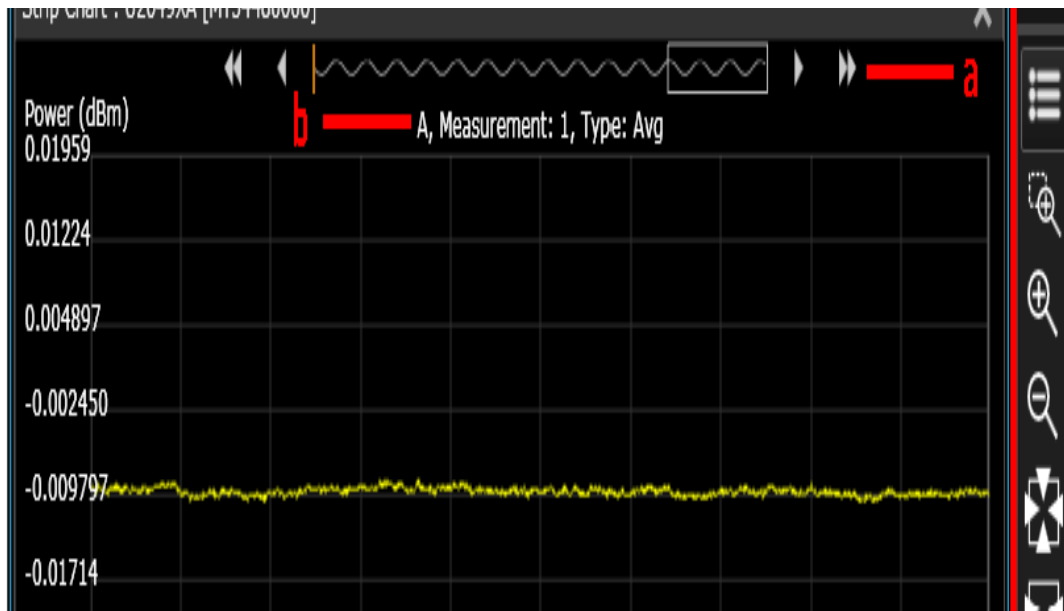
Select one of the available measurements from the list and click **Ok**.






Model No	Serial No	Meas ID	Channel	Meas Type
U2049XA	MY54480006	1	A	Avg
U2049XA	MY54480006	2	A	Avg

**Figure 2-7** Selecting one of the measurements



**Figure 2-8** Data preview bar

- a** Data preview bar
- b** Indicates the channel name, measurement number, measurement type
- c** Tools palette to provide control for the datalog chart (refer to the BenchVue Power Meter help documentation for details)
- d** Summary of marker measurements and alert limit conditions for the current measurement.

- 7 Place a marker (or up to five markers) on the chart by clicking  to obtain the reading.

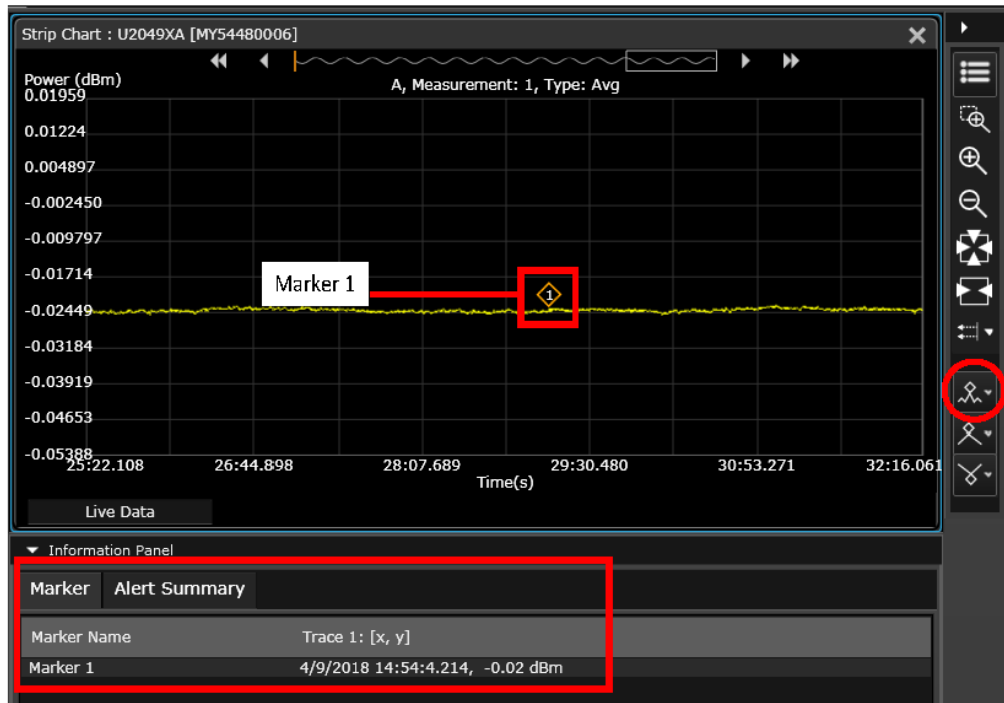


Figure 2-9 Placing a marker on the chart

## Quick start example to set up a measurement in the Trace view


The following example guides you on how to set up a basic peak power measurement for RF pulses via BenchVue.

### NOTE

The default power meter mode is Average only. It will change to the Normal mode when the Trace view is selected. As the Normal mode provides a lower dynamic range, the measurable power range will automatically narrow down.

To obtain a wider dynamic range for low power measurements ( $< -40$  dBm), you will need to set to the Average only mode. If the measurement is in the Trace view, a warning message will appear as the Trace view is only applicable for the sensor's Normal mode.

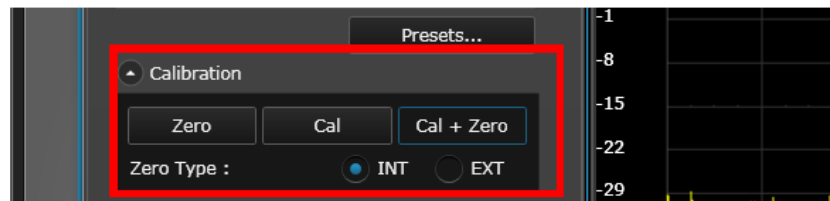
It is assumed that the 2050/60 X-Series is already connected to a signal generator.

- 1 Set up the signal generator as follows:
  - Pulse period: 500  $\mu$ s
  - Pulse width: 100  $\mu$ s
  - Amplitude: 5 dBm
  - Frequency: 1 GHz
  - Pulse: Enabled
- 2 Turn on the RF output of the signal generator. Launch the BenchVue Power Meter application (refer to **page 46**).
- 3 Create a Trace display view by clicking .



**Figure 2-10** Creating a trace

- 4 Perform calibration and zeroing for an accurate measurement result.

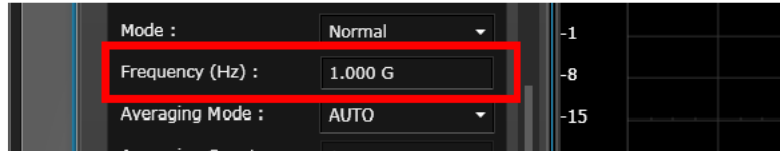


**Figure 2-11** Performing calibration and zeroing

**NOTE**

- For power measurement below -50 dBm, it is recommended to use external zero type for better accuracy and repeatability. Turn off RF output while performing external zeroing.
- Ensure that modulation is enabled.

- 5 Set the frequency of the 2050/60 X-Series to 1 GHz.




**Figure 2-12** Setting the frequency

- 6 You can set the trace scales to configure the pulse on the trace display.



**Figure 2-13** Setting the trace scales

- 7 To enable gates on the trace, click  at the Tools Palette.

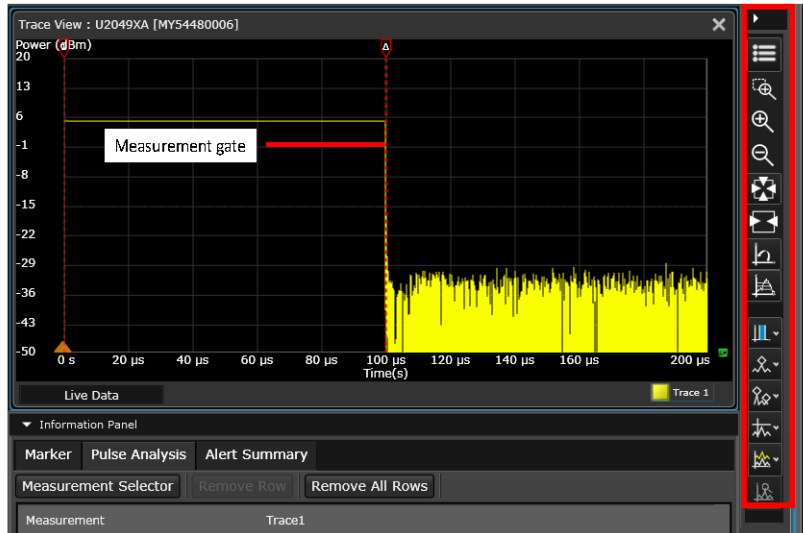


Figure 2-14 Adding marker or configuring the trace using Tools Palette controls

**NOTE**

You can add markers or configure the trace using the Tools Palette controls. Refer to the **BenchVue Power Meter help** documentation for details on each control.

For more precise control of your gate parameters, you can set up the gates via the **Instrument Setup** tab and enter a starting point and length (in seconds) for each of the four gate controls.

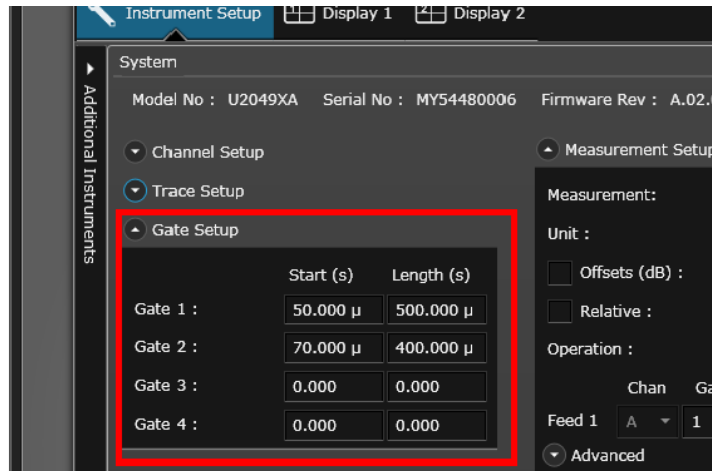
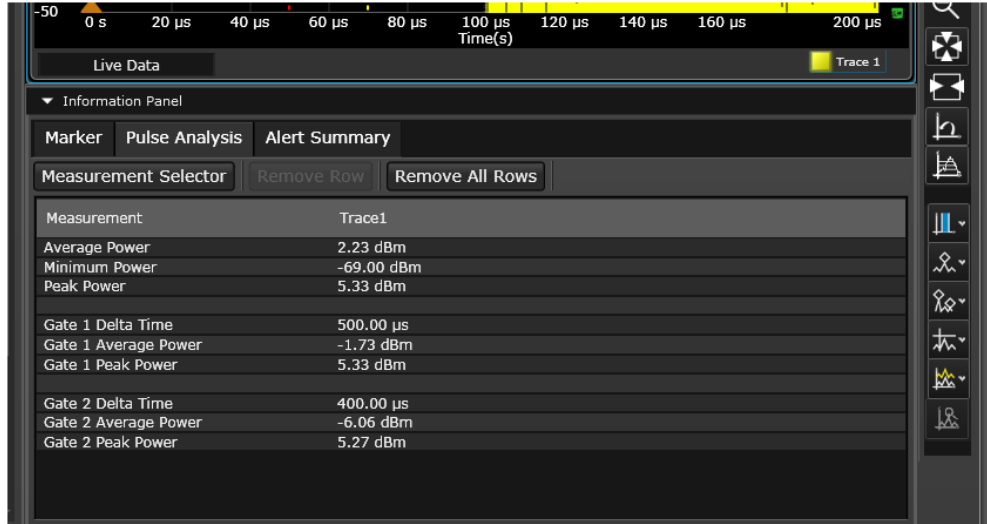


Figure 2-15 Setting the gates through Instrument Setup tab

- 8 View the power measurement results of the pulse at the **Pulse Analysis** tab under **Information Panel**.











**Figure 2-16** Viewing the power measurement results of the pulse

You can select additional pulse and gate measurements to display by clicking the **Measurement Selector** tab.

## Quick overview of the BenchVue Power Meter

### NOTE

For details on each of the BenchVue Power Meter features, refer to the Keysight BenchVue Power Meter help documentation.

- a Access the common measurement settings for the current measurement display view.
  - Click  to create a new Digital Meter display view.
  - Click  to create a new Analog Meter display view.
  - Click  to create a new Data Log display view.
  - Click  to create a new Trace display view.
  - Click  to create a new MultiList display view.
  - Click  to assign a measurement to the selected display view.
  - Click   to start or stop all assigned measurements on all display views simultaneously.

For more information, refer to “ ” on page 57 and “**Power meter settings in the Normal mode**” on page 60.

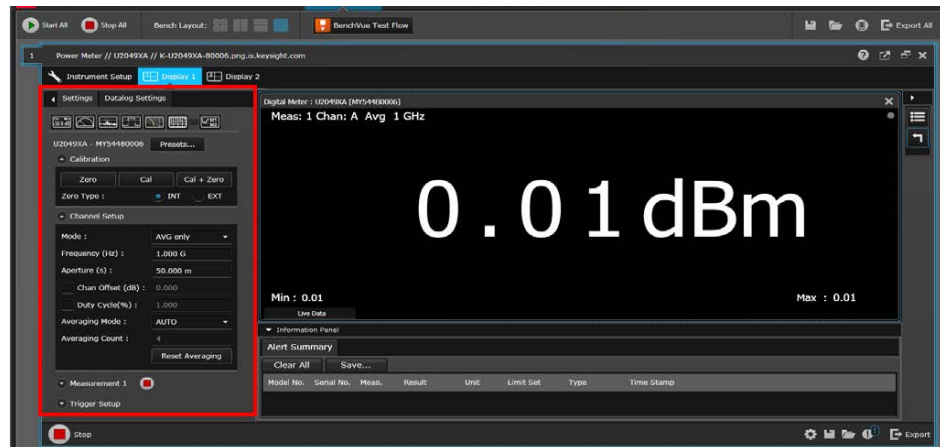


Figure 2-17 Common measurement settings pane

To access the data logger settings, click the **Datalog Settings** tab. To enable data logging, you need to stop the measurement acquisition.

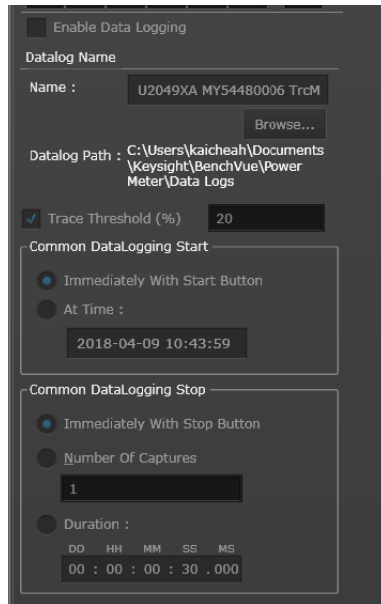


Figure 2-18 Datalog settings pane

Export the data log file and view the recorded data in Excel

Figure 2-19 Export the data log file

- b Save or load the instrument state of the current bench application in a proprietary format with a \*.state file extension.



Save the instrument state  Load the instrument state

Figure 2-20 Save/load the instrument state

- c Access advanced settings such as corrections (frequency-dependent offset, gamma, and S-parameter), alert limits, recorder output, trace/pulse duration reference levels, input impedance, and trigger output.

For more information, refer to **“Instrument Setup tab”** on page 63.



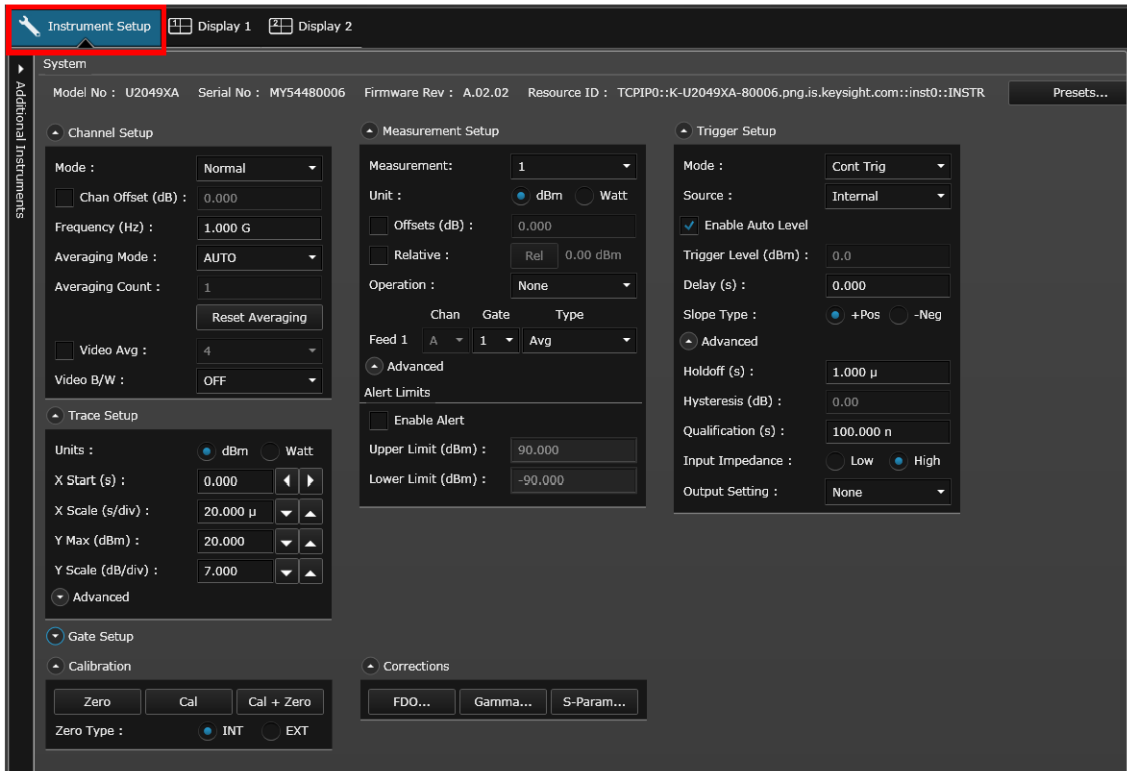


Figure 2-21 Instrument setup (advanced settings) pane

# Power meter settings in the Average only mode

## Common Average only mode power measurement settings

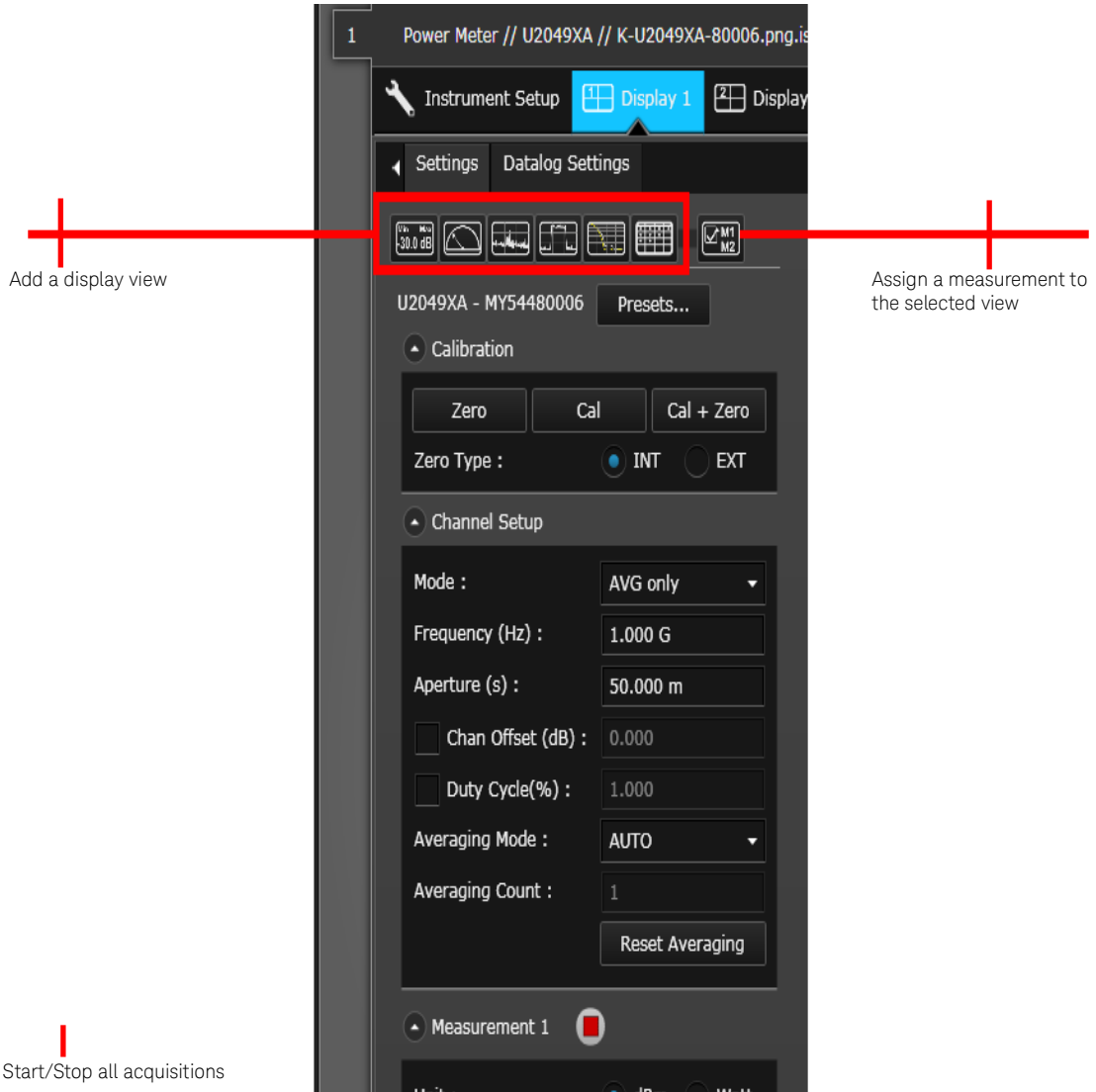


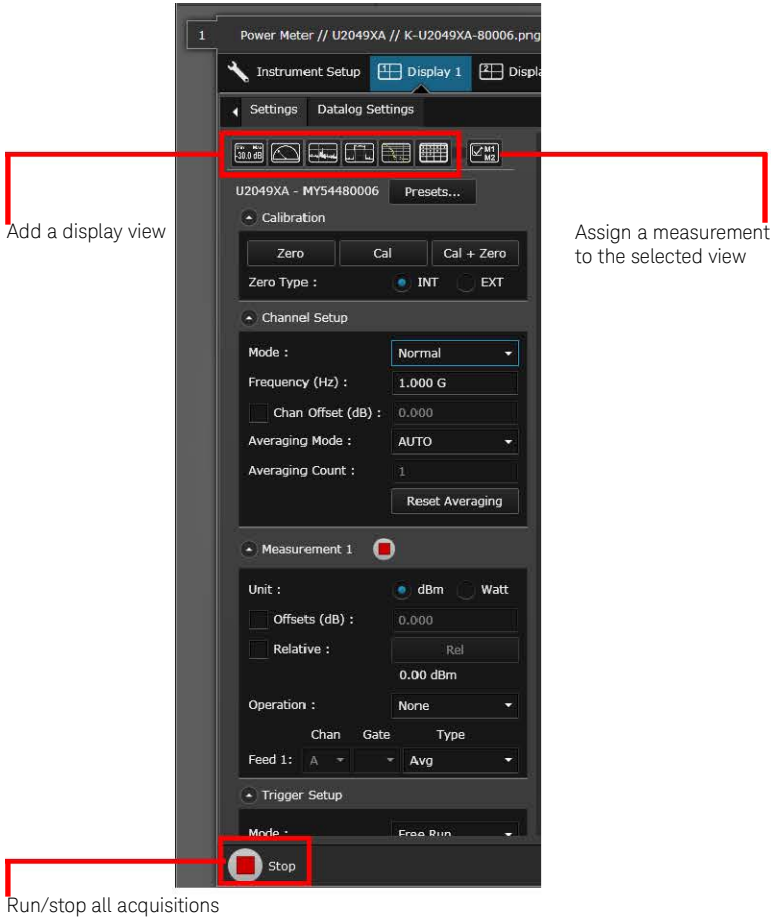
Figure 2-22 Power meter settings in the Average only mode

**Table 2-1** Power meter settings in the Average only mode description

Item	Description
Presets	<ul style="list-style-type: none"> <li>- Preset the instrument to its default values or values appropriate for measuring the communications format. The data stored in the correction (FDO, gamma, and S-parameter) tables, the selected correction table, and the zeroing and calibration data are not affected by a preset.</li> <li>- Perform a system reset.</li> </ul>
Channel Setup	<ul style="list-style-type: none"> <li>- Set the channel mode to the Normal or Average Only mode.</li> <li>- Set the measurement frequency.</li> <li>- Set the aperture size.</li> <li>- Set the channel offset which is applied to the measured power prior to any mathematical functions. Refer to <b>“Simplified Measurement Path”</b> on page 82.</li> <li>- Set the duty cycle.</li> <li>- Set the automatic or manual measurement average mode. The number of readings averaged can range from 1 to 1024. Increasing the value of the measurement average reduces measurement noise, but increases measurement time. The measurement average filter can also be reset. Refer to <b>“Typical Averaged Readings”</b> on page 83.</li> </ul>
Calibration	<p>Auto-calibrate the 2050/60 X-Series without having to connect it to a power reference, or auto-zero the 2050/60 X-Series internally or externally.</p> <p>Internal zeroing can be performed with or without the RF/microwave signal present, while external zeroing must be performed without any RF/microwave signal present.</p>
Measurement	<ul style="list-style-type: none"> <li>- Run/stop the measurement.</li> <li>- Set the logarithmic (dBm) or linear (Watt) measurement unit.</li> <li>- Set the measurement offset factor. The 2050/60 X-Series corrects every measurement by this factor to compensate for the gain/loss.</li> <li>- Enable the relative mode, which computes the measurement result relative (as a ratio) to a reference value. When enabled, the reference value can be set using the &lt;Rel&gt; control. The relative reading is displayed in either dB or %.</li> <li>- Measurement feed operation is not available in the Average only mode.</li> </ul>
Trigger Setup	<ul style="list-style-type: none"> <li>- Set the single, free run, or continuous trigger mode. The free run mode does not allow any trigger setup.</li> <li>- Set the trigger source to an external source in the single or continuous trigger mode.</li> <li>- Set the delay time to be applied between the trigger event and all the gate start times. This allows you to time-shift all the gates by the same amount with one setting change.</li> <li>- Select the positive or negative slope type to determine if the trigger event is recognized on the rising or falling edge of a signal respectively.</li> <li>- Set the holdoff time to disable the trigger mechanism after a trigger event occurs.</li> <li>- Set the qualification value.</li> </ul>

## Power meter settings in the Normal mode

Common Normal mode power measurement settings



Common Normal mode Trace view settings

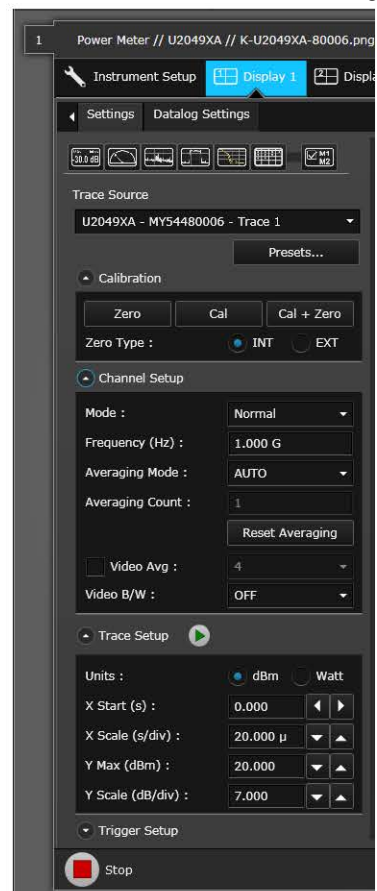


Figure 2-23 Power meter settings in the Normal mode

**Table 2-2** Power meter settings in Normal mode description

Item	Description
Presets	<ul style="list-style-type: none"> <li>- Preset the instrument to its default values or values appropriate for measuring the communications format. The data stored in the correction (FDO, gamma, and S-parameter) tables, the selected correction table, and the zeroing and calibration data are not affected by a preset.</li> <li>- Perform a system reset.</li> </ul>
Channel Setup	<ul style="list-style-type: none"> <li>- Set the channel mode to the Normal or Average Only mode.</li> <li>- Set the measurement frequency.</li> <li>- Set the channel offset which is applied to the measured power prior to any mathematical functions. Refer to <b>"Simplified Measurement Path"</b> on page 82.</li> <li>- Set the automatic or manual measurement average mode. The number of readings averaged can range from 1 to 1024. Increasing the value of the measurement average reduces measurement noise, but increases measurement time. The measurement average filter can also be reset. Refer to <b>"Typical Averaged Readings"</b> on page 83.</li> </ul>
Calibration	<p>Auto-calibrate the 2050/60 X-Series without having to connect it to a power reference, or auto-zero the 2050/60 X-Series internally or externally.</p> <p>Internal zeroing can be performed with or without the RF/microwave signal present, while external zeroing must be performed without any RF/microwave signal present.</p>
Measurement	<ul style="list-style-type: none"> <li>- Run/stop the measurement.</li> <li>- Set the logarithmic (dBm) or linear (Watt) measurement unit.</li> <li>- Set the measurement offset factor. The 2050/60 X-Series corrects every measurement by this factor to compensate for the gain/loss.</li> <li>- Enable the relative mode, which computes the measurement result relative (as a ratio) to a reference value. When enabled, the reference value can be set using the &lt;Rel&gt; control. The relative reading is displayed in either dB or %.</li> <li>- Enable the difference or ratio measurement, or disable all operations between feed 1 and feed 2.</li> <li>- Configure the gate and acquired measurement type for the feed.</li> </ul>
Trigger Setup	<ul style="list-style-type: none"> <li>- Set the single, free run, or continuous trigger mode. The free run mode does not allow any trigger setup.</li> <li>- Set the trigger source to an internal or external source.</li> <li>- Enable auto level or manually set the trigger level for the internal trigger source.</li> <li>- Set the delay time to be applied between the trigger event and all the gate start times. This allows you to time-shift all the gates by the same amount with one setting change.</li> <li>- Select the positive or negative slope type to determine if the trigger event is recognized on the rising or falling edge of a signal respectively.</li> <li>- Set the holdoff time to disable the trigger mechanism after a trigger event occurs.</li> <li>- Set the hysteresis to help generate a more stable trigger by preventing triggering unless the RF power level achieves the trigger level and the additional hysteresis value. It can be applied to both rising and falling edge trigger generation. Hysteresis is only available for the internal trigger source and manual trigger level.</li> <li>- Set the qualification value.</li> </ul>

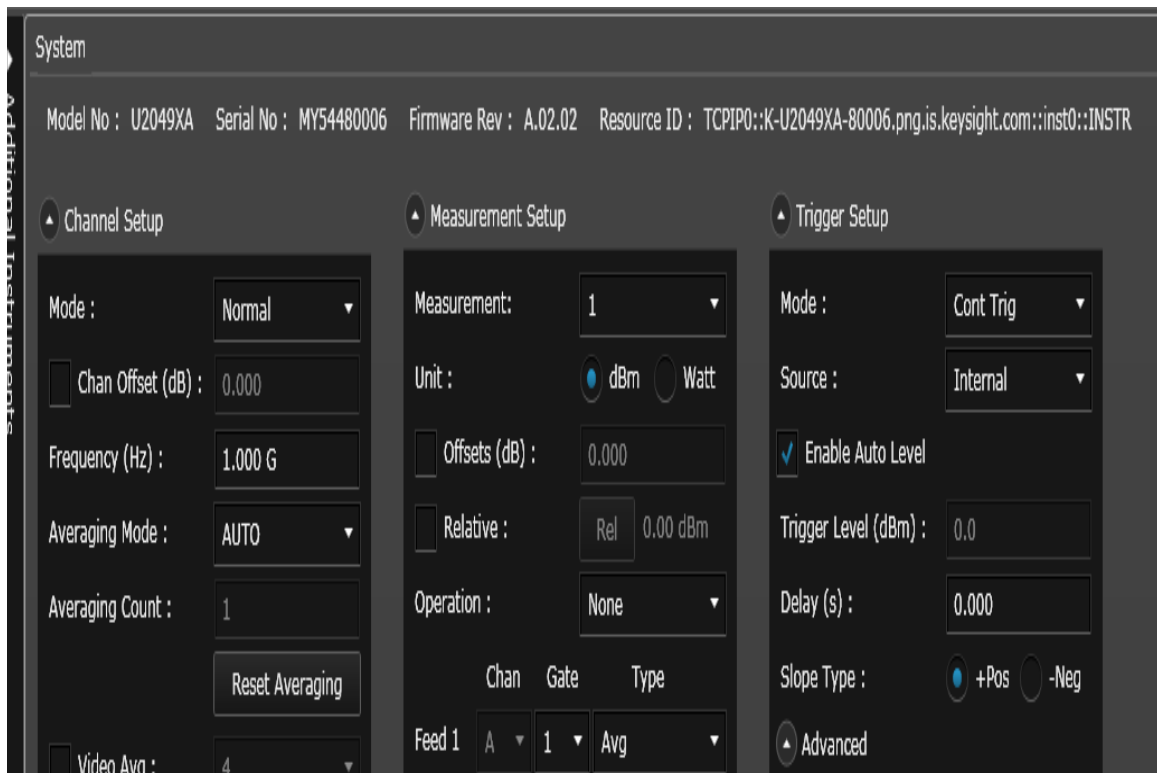
**Table 2-2** Power meter settings in Normal mode description (continued)

Item	Description
Channel Setup (in the Trace view)	<ul style="list-style-type: none"> <li>- Set the video averaging to average repetitions of a triggered signal, with a count of 1 to 256 in multiples of 2<sup>n</sup>. With video averaging, the average of a number of acquisitions is calculated to smooth the displayed trace and reduce apparent noise. The measurement requires a continuously repeating signal.</li> <li>- Set the video bandwidth. The Low, Medium, and High pass band shapes achieved by the video bandwidth settings provide flat filter responses with very sharp cut-off points by applying digital signal processing techniques to ensure accurate power measurement within the specified band. When the video bandwidth is set to Off, it removes all digital signal conditioning. This provides less than 3 dB roll-off<sup>[a]</sup> and is best suited for capturing an accurate trace, minimizing overshoot, and removing any ringing effects caused by the sharp cut-off filters used in the Low, Med, and High settings. Refer to “<b>Bandwidth Filter Shapes</b>” on page 85.</li> </ul>
Trace Setup	Set the trace unit, start time, X-axis scale, Y-axis maximum value, and Y-axis scale.
Trigger Setup (in the Trace view)	Select to enable trace for the single and continuous trigger modes.

[a] When the 2050/60 X-Series frequency is set to  $\geq 300$  MHz.

## Instrument Setup tab

This tab provides you an option to configure additional instrument settings for your measurements as described in **Table 2-3**.



**Figure 2-24** Instrument Setup tab

**Table 2-3** Additional Instrument Setup tab settings description

Item	Available settings
Trace Setup	<p><b>Advanced:</b></p> <ul style="list-style-type: none"> <li>- Set the trace reference levels to be used in the calculation of transition durations and occurrences. This allows transition measurements between non-standard reference levels.</li> <li>- Set the trace reference level to be used in the calculation of pulse durations. This allows pulse duration measurements between non-standard reference levels.</li> </ul>
Gate Setup	<p>Set the gate start time and length. The gate start time is relative to the trigger event. Positive values set a measurement gate to a maximum time of 1 second after the trigger. Negative values set a measurement gate to a maximum time of 1 second before the trigger. Refer to <b>“Measurement Gates”</b> on page 86 for more information.</p>
Corrections	<ul style="list-style-type: none"> <li>- Set the frequency-dependent offset (FDO) which compensates for frequency-related changes in the response of your test system. The BenchVue Power Meter application can store 10 FDO tables with 512 frequency points each.</li> <li>- Set the gamma and S-parameter corrections. The BenchVue Power Meter application can store 10 gamma/S-parameter tables with 1024 magnitude-phase pairs each. Also refer to <b>“Simplified Measurement Path”</b> on page 82 for the above corrections.</li> </ul>
Measurement Setup	<p><b>Advanced:</b></p> <p>Enable alerts to detect when a measurement has crossed over a predefined upper and/or lower limit value. Refer to <b>“Limit Checking Application Example”</b> on page 87 for more information.</p>
Trigger Setup	<p><b>Advanced:</b></p> <ul style="list-style-type: none"> <li>- Set the input impedance for the external TTL trigger to Low (50 <math>\Omega</math>) or High (100 k<math>\Omega</math>).</li> <li>- Enable the trigger output where a TTL level high is produced at the Trig Out connector when the 2050/60 X-Series is triggered.</li> <li>- Enable the 10 MHz timebase.</li> </ul>
Additional Instruments	<p>View all connected instruments and select any instrument to use on the BenchVue Power Meter application. You can connect up to 15 instruments per BenchVue Power Meter application.</p>




# Overview of Multiple Power Sensor Operation

This section provides examples on how to operate multiple sensors using the BenchVue Power Meter application.

## Single bench operation

### Multiple Digital Meter display views

Select the instruments to use at **Instrument Setup > Additional Instruments**. Add up to four Digital Meter display views by clicking  and selecting the measurement sources to display.

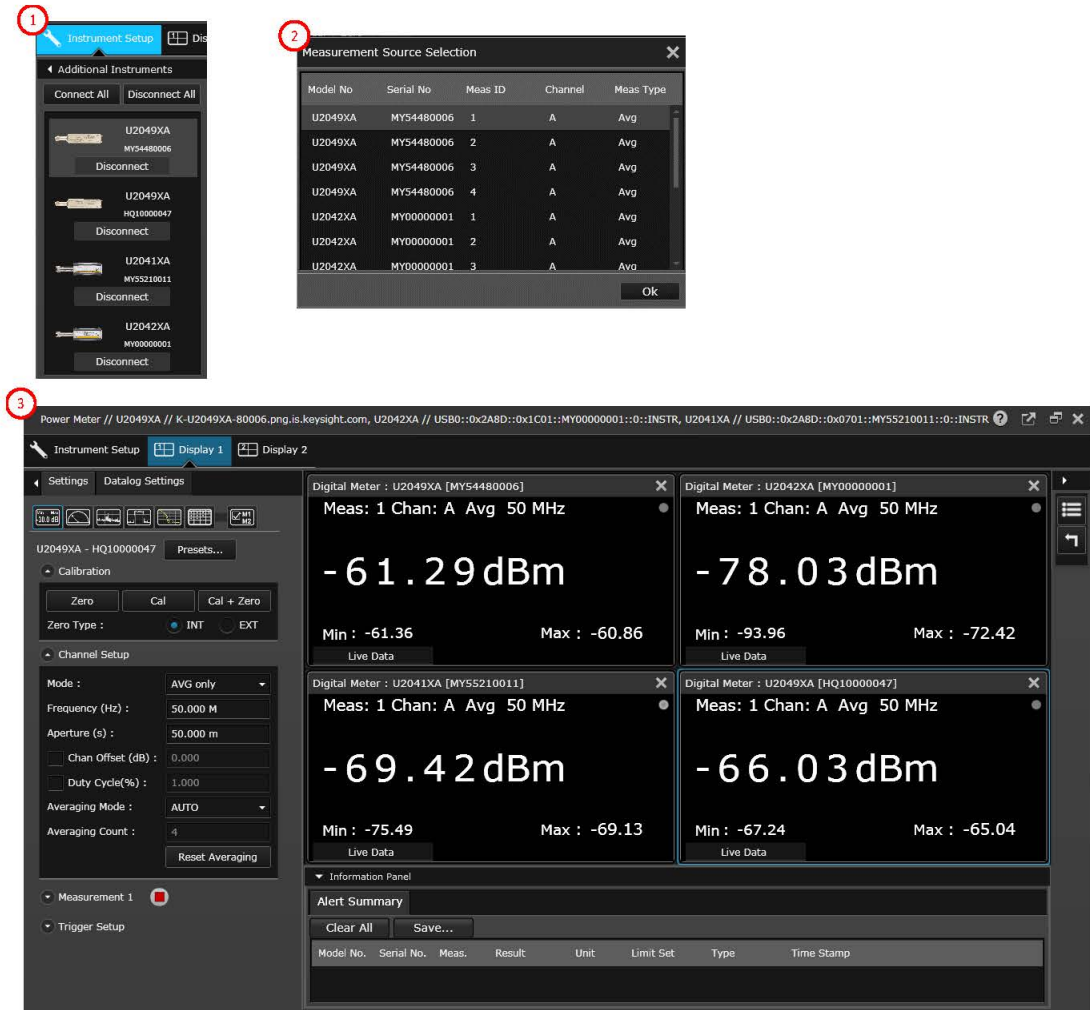



Figure 2-25 Multiple Digital Meter display example

## Multi-list display view

Select the instruments to use at **Instrument Setup > Additional Instruments**. Add a Multilist display view by clicking  and selecting the measurement sources to display.

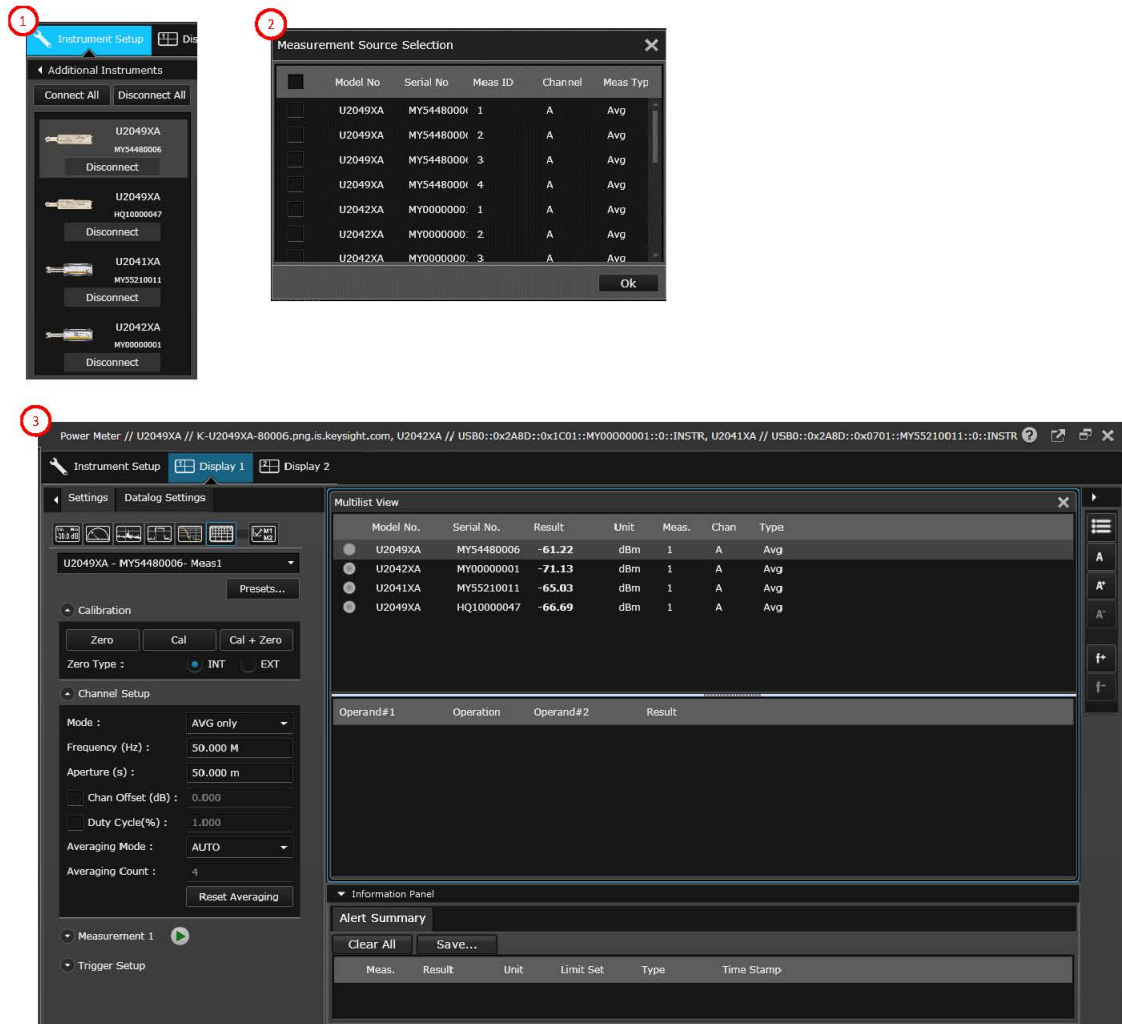



Figure 2-26 Multi-list display example

## Single Trace display view with multiple traces

Select the instruments to use at **Instrument Setup > Additional Instruments**. Add a Trace display view by clicking  and selecting the trace sources to display.

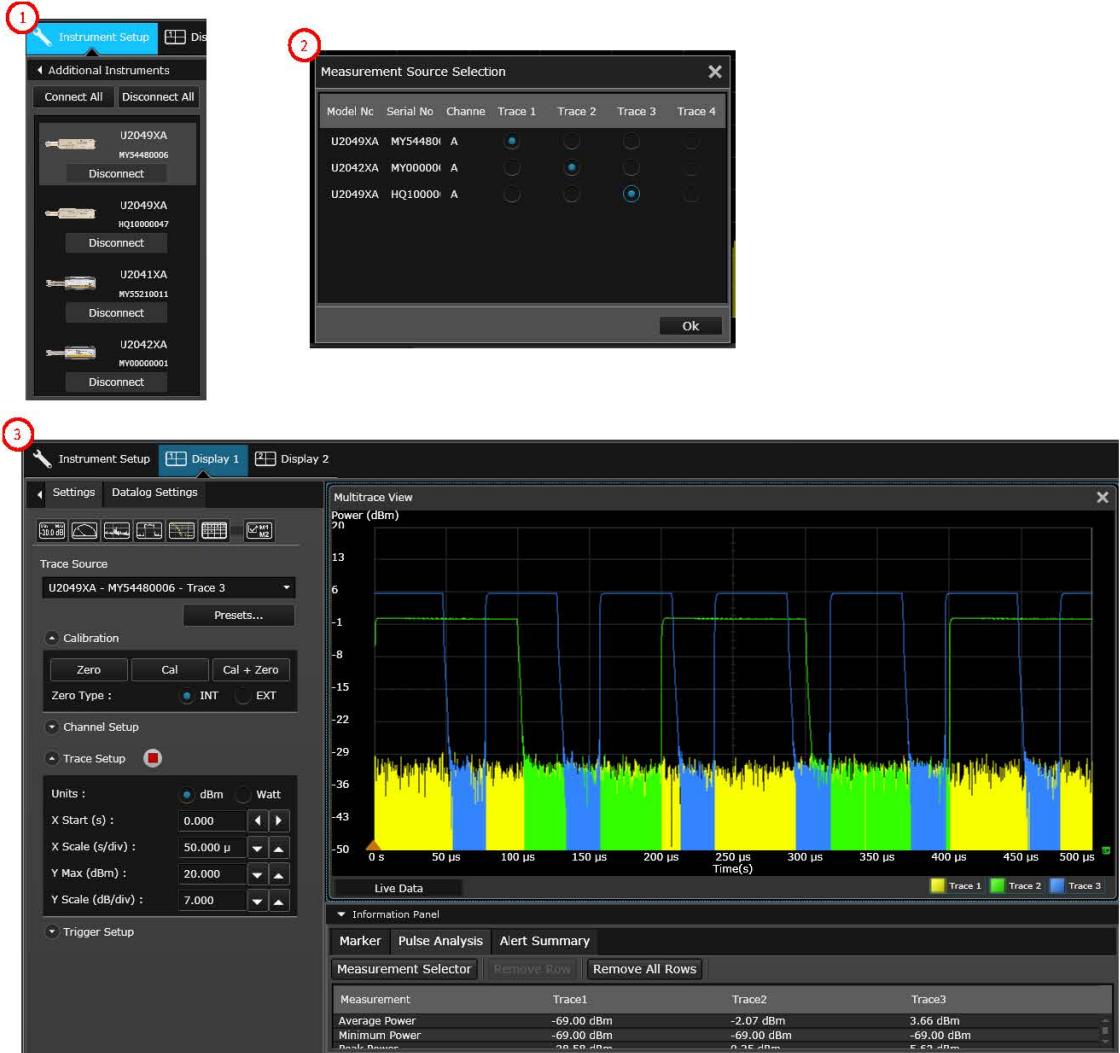


Figure 2-27 Multi-trace example

## Multiple bench operation

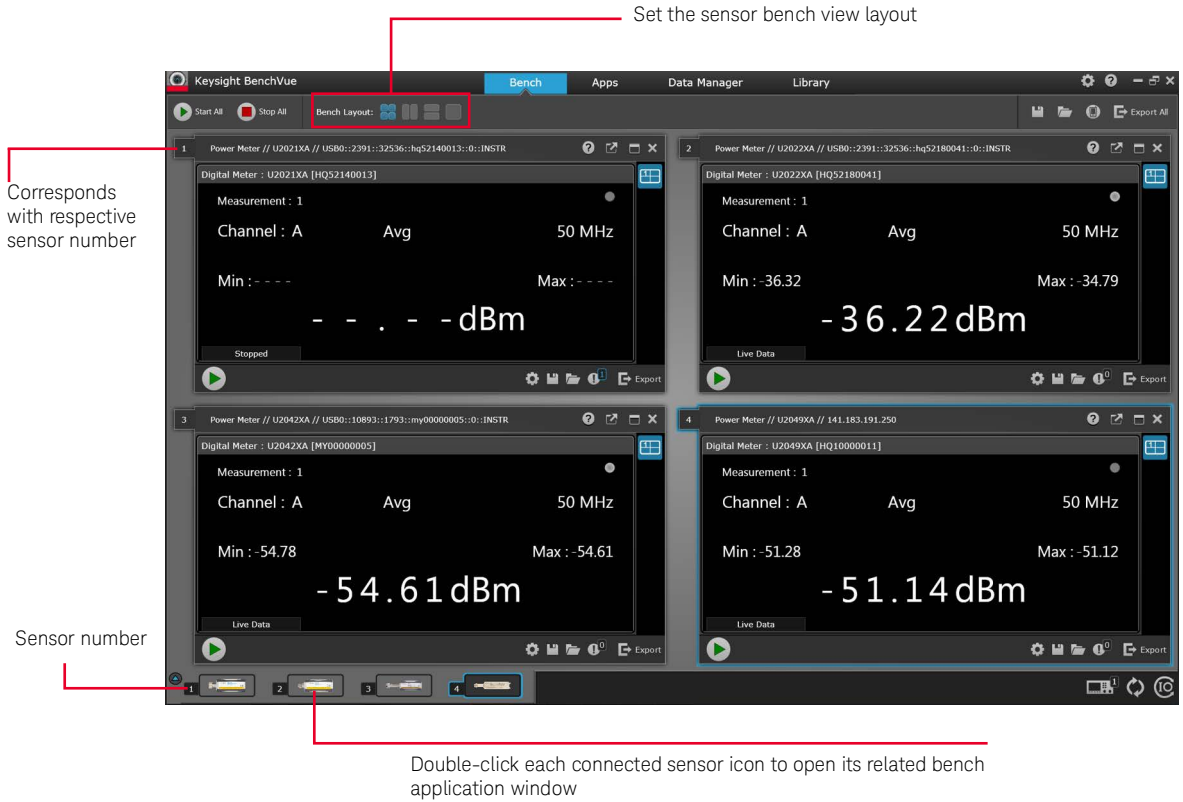


Figure 2-28 Multiple bench display example

## Exploring the 2050/60 X-Series Web Interface

You can use the 2050/60 X-Series's Web Browser Interface for remote access and control of the instrument via a Web browser, such as Google Chrome, Microsoft Edge and Opera. Using the Web Interface, you can configure, troubleshoot, and monitor your system remotely. This section provides an overview of the 2050/60 X-Series Web Interface.

### Launching the web interface

- 1 Open your Internet browser from your computer.
- 2 From the **Tools > Internet Options** menu, navigate to **Connections** (exact navigation depends on your browser), and then select **LAN Settings**.
- 3 From the LAN Settings dialog, select/activate bypass proxy server for local addresses (exact terminology depends on your browser).
- 4 Exit the Options window.
- 5 Enter the IP address of the 2050/60 X-Series in the Address field and press **Enter**.
- 6 After entering the appropriate IP address, the 2050/60 X-Series Web Interface's Welcome Window should appear.

#### NOTE

The procedure in this section helps you understand the tasks commonly performed using the 2050/60 X-Series Web Interface. For additional help about using the interface, click **Help with the Page** tab on the lower-left corner of the Web Interface window.

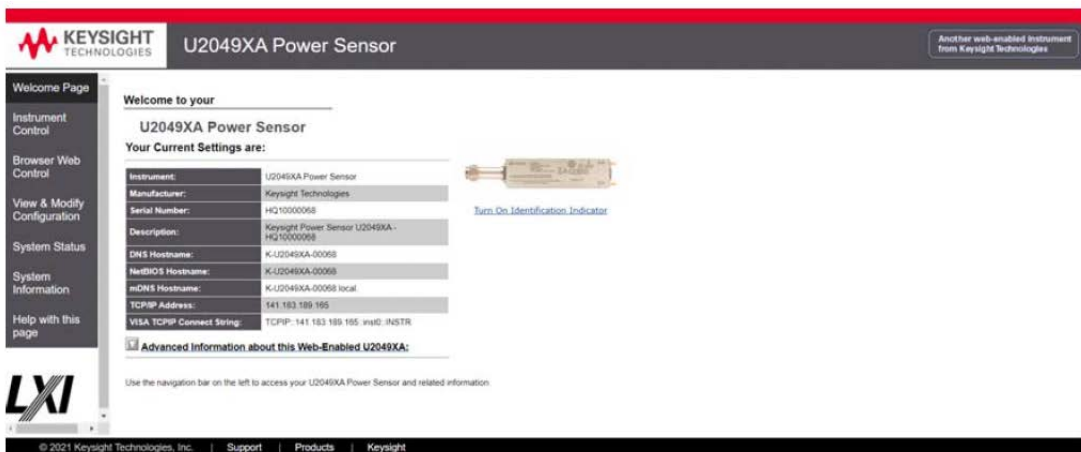


Figure 2-29 2050/60 X-Series Web Interface's Welcome Window

### Navigation Bar

Welcome Page	<b>Welcome page:</b> Displays the detailed information.
Instrument Control	<b>Instrument Control:</b> Allows you to control the configuration of sensor setting, through different HTML input types (such as: buttons/text input/radio buttons and so on).
Browser Web Control	<b>Browser Web Control:</b> Displays the SCPI command interface for sending/reading SCPI commands.
View & Modify Configuration	<b>View &amp; Modify Configuration:</b> Displays the instrument configuration information. It also allows you to modify it.
System Status	<b>System Status:</b> Displays the status of the instrument (name, serial number and status).
System Information	<b>System Information:</b> Displays the instrument firmware information.
Help with this page	<b>Help with this Page</b> Displays the Help file

Figure 2-30 Navigation bar

## Displaying the Instrument control page

- 1 From the Welcome Window, click **Instrument Control** tab on the left side of the window.
- 2 Click **Enter Password**.  
A pop-up window appears, requesting for password.
- 3 Enter password (default password is “keysight”) and click **Submit**.  
You can view the instrument control panel of the 2050/60 X-Series sensors.

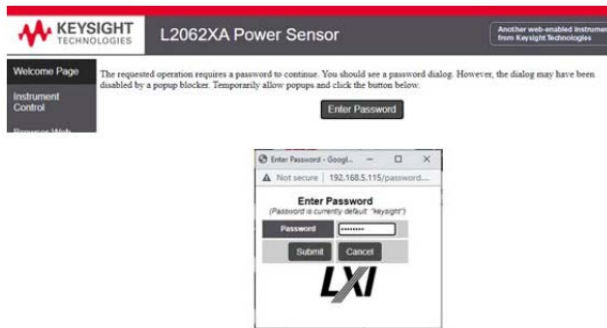


Figure 2-31 Password Panel

- Using various available HTML buttons/text input/radio buttons, you can control configuration of sensor settings in the instrument control panel.

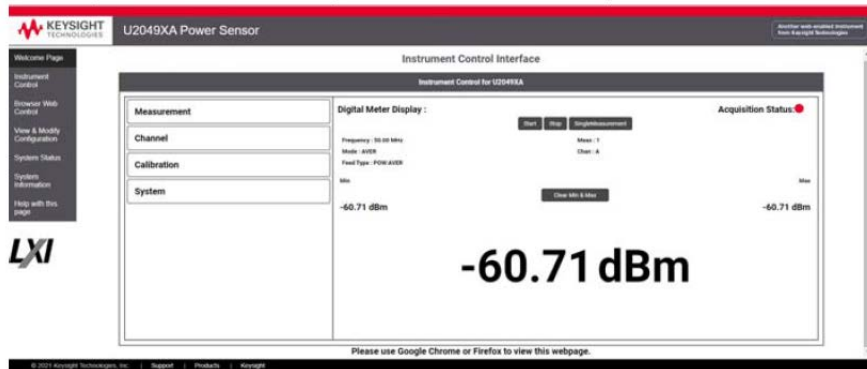


Figure 2-32 Instrument control panel

## Measurement Panel

Measurement panel allows you to configure unit selection, measurement offset and measurement relative settings.

- 1 Unit – Sets the power measurement unit for the specified CALCulate block. By default, it is set to dBm. The corresponding SCPI command is `UNIT[1]2|3|4:POWer W|DBM`.
- 2 Offset – Sets the offset value on the specified CALCulate block. Select **Offset (dB)** check box for the offset text box to appear and enter the desired value to set the offset value. Deselect the check box to disable the offset field. By default, this field is disabled. The corresponding SCPI command is `CALCulate[1]2|3|4:GAIN[:MAGNitude]`.
- 3 Relative – Enable/disable the relative mode. Select **Relative** check box to apply the current relative value set by `CALCulate:RELative:MAGNitude:AUTO` to the measurement signal. Deselect the check box so that the measurement signal remains unchanged. By default, this field is disabled. The corresponding SCPI command is `CALCulate[1]2|3|4:RELative:STATE ON|OFF|1|0`.

When the sensor is set to NORMAL mode in Channel panel, additional options are added in the measurement panel that allow you to configure the operation type and feed of the measurement signal.

The screenshot shows a web interface for the Measurement panel. At the top, there is a header box labeled "Measurement". Below it, the label "Measurement :" is followed by three settings:

- Unit :** Two radio buttons are present: "dBm" (which is selected with a blue dot) and "Watt".
- Offset(dB) :** A checked checkbox is followed by a text input field containing the value "0.00".
- Relative :** A checked checkbox is followed by a dark grey button labeled "Relative".

At the bottom of the panel, there is a small "--" separator.

**Figure 2-33** Measurement Relative setting

- 4 Operation – Sets the specified CALCulate block to None, (single channel), Difference or Ratio measurement. The corresponding SCPI command is `CALCulate[1]2|3|4:MATH[:EXPRession] "(SENS1)"|(SENS1-SENS1)"|(SENS1/SENS1)"`.
- 5 Feed 1/Feed 2 – Sets the input measurement mode to be fed into the specified input on the CALCulate block. Currently, the Channel and Gate options are set by the system and you cannot to change them in Phase1, the web interface allows you to set the Feed type to Avg, Peak, Pk-Avg and Min. The corresponding SCPI command is `CALCulate[1]2|3|4:FEED[1]2 "POW:PEAK"|"POW:PTAV"|"POW:AVER"|"POW:MIN"`.



**Measurement**

**Measurement :**

Unit :  dBm  Watt

Offset(dB) :

Relative :

Operation :

Chan :  Gate :  Type :

**Figure 2-34** Operation and Feed Setting

## Channel Panel

In channel panel, you can configure channel mode, channel frequency, aperture time, channel offset, duty cycle and averaging mode settings.

When the sensor is set to NORMAL mode, you can configure channel mode, channel frequency, channel offset and averaging mode + averaging count

- 1 Channel Mode – Sets the measurement mode to normal or average. Select **Average** or **Normal** mode from the drop down. By default, the power sensor is set to Average mode. The corresponding SCPI command is [:SENSe[1]:]DETEctor:FUNCTion.
- 2 Channel Frequency – Sets the frequency of the signal. Select the desired unit from the drop down and enter the frequency value. The frequency range allowed for 2050/60 X-Series sensors is 1 kHz to 1000 GHz. By default, the frequency is set to 50 MHz. The corresponding SCPI command is [:SENSe[1]:]FREQUency[:CW]:FIXed <numeric\_value>.
- 3 Chan Offset – Sets the channel offset for 2050/60 X-Series sensors. Select **Chan Offset (dB)** check box for the channel offset text box to appear and enter the desired value to set the channel set value. Deselect the check box to disable the channel offset value. By default, this setting is disabled. The corresponding SCPI commands are [:SENSe[1]:]CORRection:GAIN2[:INPut]:STATe ON|OFF|1|0 and [:SENSe[1]:]CORRection:GAIN2[:INPut][:MAGNitude] <numeric\_value>
- 4 Averaging mode – Sets the averaging mode. Select one of the averaging mode options (AUTO/MANUAL /OFF) from the drop down. By default, the averaging mode is set to AUTO.
  - a AUTO – Enables averaging and automatic filter length. The corresponding SCPI command is [:SENSe[1]:]AVERAge:COUNT:AUTO ON|1
  - b MANUAL – Enables averaging, but disables automatic filter length, therefore the filter length can be manually set in the averaging count text box. The corresponding

SCPI command is [:SENSe[1]:]AVERAge:COUNT:AUTO OFF|0 +  
[:SENSe[1]:]AVERAge:COUNT <numeric\_value>

- c OFF – Disables averaging. The corresponding SCPI command is [:SENSe[1]:]AVERAge[:STATe] OFF|0  
When the sensor is set to AVERAGE mode, an additional setting is added in the channel panel that allows you to configure aperture time and duty cycle

**Channel**

**Channel Setup :**

Mode : Normal ▼

Frequency : 50.00 MHz ▼

Chan Offset(dB) : 10.00

Averaging Mode : AUTO ▼

Reset Averaging

**Figure 2-35** Channel Setup -Normal Mode

- 5 Aperture time – Sets the aperture duration or measurement interval. Select the unit from the drop down and enter the aperture time value. The range of aperture time allowed for 2050/60 X-Series sensors is 20us to 200ms for  $\geq 300$  MHz. For  $<300$  MHz, the minimum aperture size is 50us. By default, the aperture is 50ms. The corresponding SCPI command is [:SENSe[1]:]SWEp:APERture <numeric\_value>.
- 6 Duty cycle – Sets the pulse power measurement value. Select **Duty Cycle()** check box for the duty cycle text box to appear and enter the desired value. Deselect the check box to disable the pulse power measurement value. By default, this field is disabled. The corresponding SCPI command is [:SENSe[1]:]CORRection:DCYCLE|GAIN3:STATe ON|OFF|1|0 and [:SENSe[1]:]CORRection:DCYCLE|GAIN3[:INPut][:MAGNitude] <numeric\_value>

**Channel**

**Channel Setup :**

Mode : Average ▼

Frequency : 50.00 MHz ▼

Aperture(s) : 50.00 ms ▼

Chan Offset(dB) : 10.00

Duty Cycle() : |

Averaging Mode : AUTO ▼

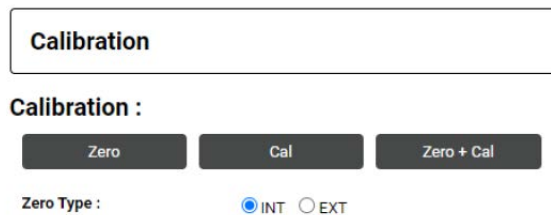
Reset Averaging

**Figure 2-36** Channel Setup – Average Mode

## Calibration Panel

In calibration panel, the following three buttons can be used to trigger the calibration subsystem to perform zero calibration and auto calibration on the 2050/60 X-Series sensors:

- 1 Zero – Click to execute the auto-zeroing routine on channel A. The corresponding SCPI command is CAL:ZERO:AUTO ONCE.
- 2 Cal – Click to perform auto-calibration on channel A. The corresponding SCPI command is CAL:AUTO ONCE.
- 3 Zero + Cal – Click to perform zero as well as auto calibration (CALibration[1]:ZERO:AUTO ONCE + CALibration[1]:AUTO ONCE) on Channel A. The corresponding SCPI command is CAL:ALL.
- 4 Zero Type – Sets the external or internal zeroing mode. The corresponding SCPI command is CAL:ZERO:TYPE INT|EXT.

**Figure 2-37** Calibration Panel

## System Panel

The System panel allows you to select one of the following options:

- 1 Presets – This button is still under development in Phase 1. Currently, only DEFAULT preset option is supported.
- 2 Reboot – This button reboots the sensor..
- 3 IO Timeout – Sets the timeout period for the sensor so that it waits before the complete execution of SCPI read command in case it fails to return the corresponding result. Currently the limit is set between 5s – 60s.
- 4 Auto Measurement Time – Sets the refresh rate of displaying the reading on Digital Meter Display Panel.
- 5 System Connection Status – Shows the status of the web server connection. It shows “Connected” when the connection is established, else it shows “Disconnected. You may consider restarting the sensor in case you face any issues with the web server connection.

- 6 Toggle Dark Mode – Toggles between dark mode and bright mode layout for the web interface. Dark mode displays the background in black color, whereas bright mode background in white color.

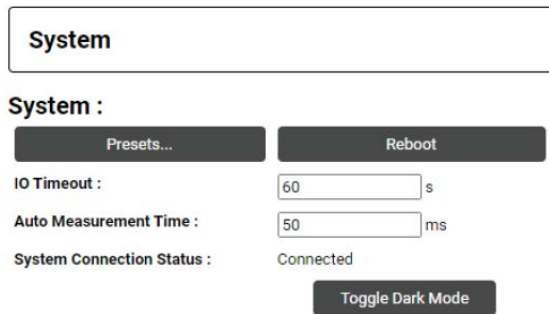


Figure 2-38 System panel

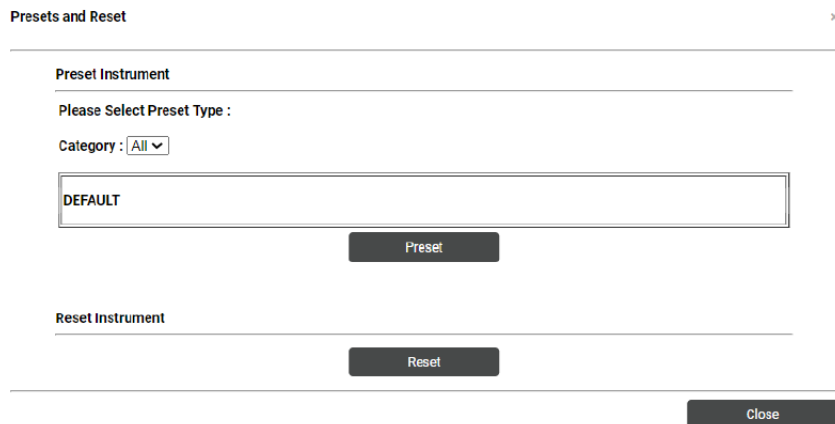


Figure 2-39 System Panel - Presets and Reset

## Digital Meter Display Panel

In Digital Meter Display panel, the following buttons are used to trigger the measurement: 1) Start 2) Stop 3) Single Measurement and displaying information on current measurement such as 4) Current Measuring Information: Frequency, Mode, Feed Type, Meas, Chan 5) Min and Max measurement logged 6) A Clear the min and max button to clear the minimum and maximum value logged 7) Power Measurement Value.



Figure 2-40 Digital Meter Display

## Footer

This Web Interface is supported and can be best viewed with the latest version of Google Chrome, Opera and Microsoft Edge web browsers.

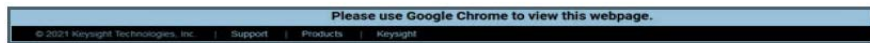


Figure 2-41 Footer

## System Error

There is a System Error bar on the top of the Web Interface, to display the error message returned from the execution of a SCPI command.

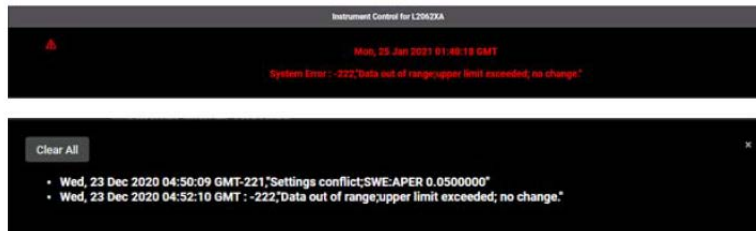


Figure 2-42 System error

THIS PAGE HAS BEEN INTENTIONALLY LEFT BLANK.

Keysight 2050/60 X-Series  
Wide Dynamic Range Power Sensors  
User's Guide

## 3 Characteristics and Specifications

**NOTE**

For the characteristics and specifications of the 2050/60 X-Series, refer to the datasheet at <https://www.keysight.com/my/en/assets/3120-1424/data-sheets/U2049XA-Option-TVA-UL205060-X-Series-USBLAN-Wide-Dynamic-Range-Peak-Average-Power.pdf>.

---

THIS PAGE HAS BEEN INTENTIONALLY LEFT BLANK.

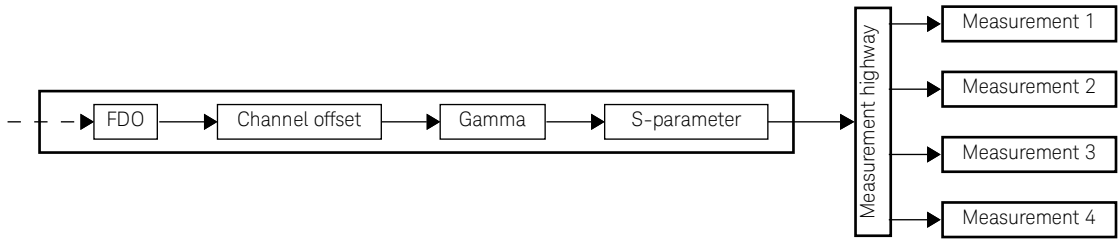


Keysight 2050/60 X-Series  
Wide Dynamic Range Power Sensors  
User's Guide

## A Appendix

Simplified Measurement Path	82
Typical Averaged Readings	83
Bandwidth Filter Shapes	85
Measurement Gates	86
Limit Checking Application Example	87

# Simplified Measurement Path



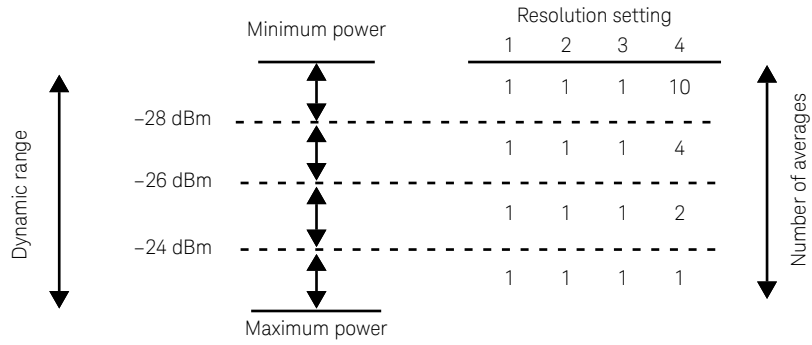
# Typical Averaged Readings

Below shows the typical number of averages for each range and resolution when the 2050/60 X-Series is in the auto-average mode and set to the normal speed mode.

	Minimum power	Resolution setting			
		1	2	3	4
< -70 dBm		100	100	100	100
-70 dBm		100	100	100	100
-68 dBm		100	100	100	100
-66 dBm		100	100	100	100
-64 dBm		100	100	100	100
-62 dBm		65	100	100	100
-60 dBm		26	100	100	100
-58 dBm		10	100	100	100
-56 dBm		4	100	100	100
-54 dBm		2	100	100	100
-52 dBm		1	65	100	100
-50 dBm		1	26	100	100
-48 dBm		1	10	100	100
-46 dBm		1	4	100	100
-44 dBm		1	2	100	100
-42 dBm		1	1	65	100
-40 dBm		1	1	26	100
-38 dBm		1	1	10	100
-36 dBm		1	1	4	100
-34 dBm		1	1	2	100
-32 dBm		1	1	1	65
-30 dBm		1	1	1	26

Dynamic range

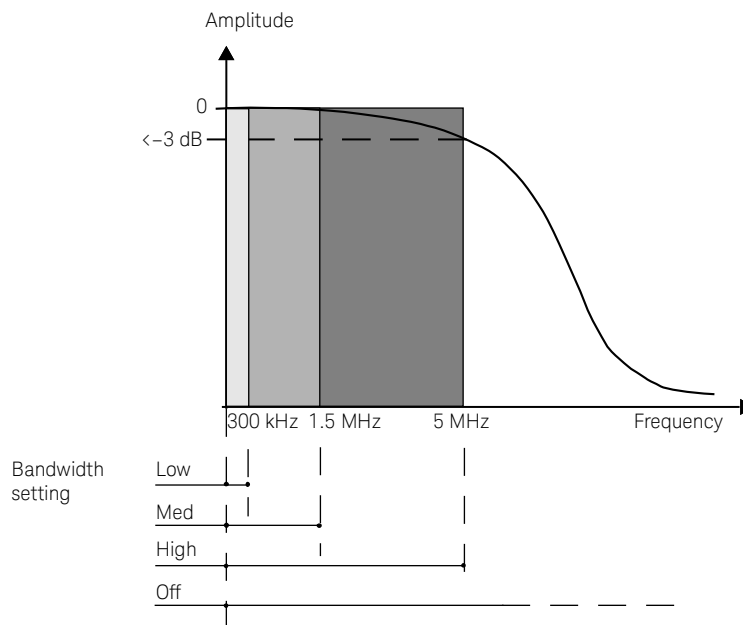
Number of averages



The four resolution levels represent:

- 1, 0.1, 0.01, 0.001 dB respectively if the measurement suffix is dBm or dB.
- 1, 2, 3, or 4 significant digits respectively if the measurement suffix is W or %.

# Bandwidth Filter Shapes<sup>[1]</sup>



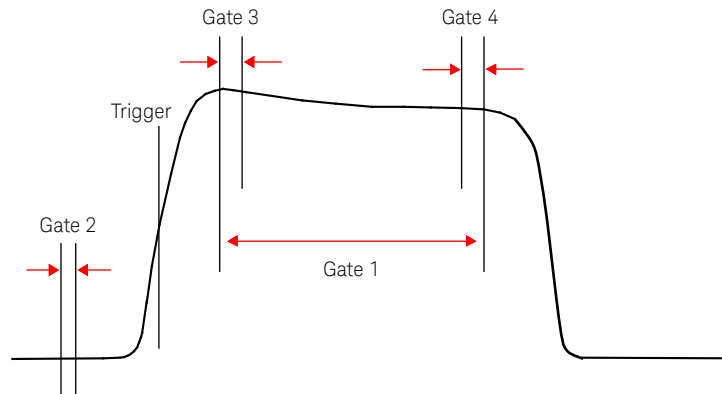
[1] When the 2050/60 X-Series frequency is set to  $\geq 300$  MHz.

## Measurement Gates

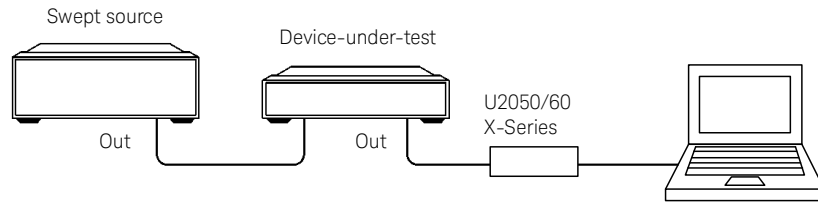
A measurement gate allows measurements to be performed on particular sections of the input signal. The gate is defined by a start time relative to the trigger event and a duration. Signal samples acquired during the time interval specified by the gate are used for the measurements in that gate. A system of up to four independent gates is provided.

Below is an example of a 4-gate setup to perform the following measurements simultaneously:

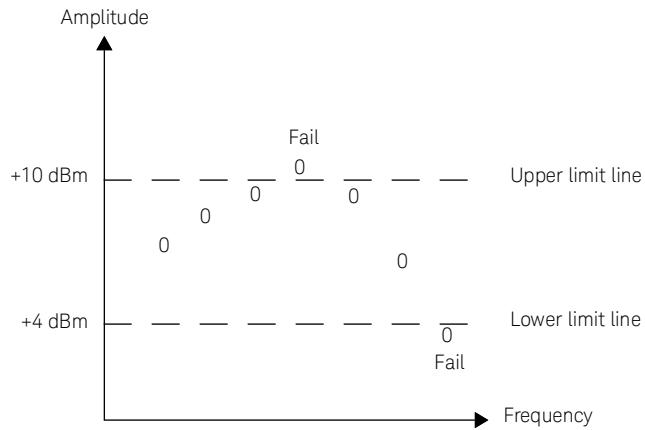
Average power level of the pulse	Gate 1, average measurement
Average "off" power level ahead of the pulse	Gate 2, average measurement
Peak-to-average ratio	Gate 1, peak-to-average measurement
Pulse droop	Gate 3, average measurement, minus Gate 4, average measurement



## Limit Checking Application Example



The limits have been set at +4 dBm and +10 dBm for the above application. A fail occurs each time the output power is outside these limits as shown below.



**Table A-1** Range of values for limits

Unit	Maximum	Minimum	Default maximum	Default minimum
dB	+200 dB	-180 dB	60 dB	-120 dB
dBm	+230 dBm	-150 dBm	90 dBm	-90 dBm
%	10.0 Z%	100.0 a%	100.0 M%	100.0 p%
W	100.000 EW	1.000 aW	1.000 MW	1.000 pW

THIS PAGE HAS BEEN INTENTIONALLY LEFT BLANK.



This information is subject to change without notice. Always refer to the English version at the Keysight Web site for the latest revision.

© Keysight Technologies 2015–2024  
Edition 7, February 5, 2024

Printed in Malaysia



U2063-90002

[www.keysight.com](http://www.keysight.com)