

# 1560

## Back Stack Thermometer Readout

### User's Guide

## **LIMITED WARRANTY AND LIMITATION OF LIABILITY**

Each Fluke product is warranted to be free from defects in material and workmanship under normal use and service. The warranty period is two years and begins on the date of shipment. Parts, product repairs, and services are warranted for 90 days. This warranty extends only to the original buyer or end-user customer of a Fluke authorized reseller, and does not apply to fuses, disposable batteries, or to any product which, in Fluke's opinion, has been misused, altered, neglected, contaminated, or damaged by accident or abnormal conditions of operation or handling. Fluke warrants that software will operate substantially in accordance with its functional specifications for 90 days and that it has been properly recorded on non-defective media. Fluke does not warrant that software will be error free or operate without interruption.

Fluke authorized resellers shall extend this warranty on new and unused products to end-user customers only but have no authority to extend a greater or different warranty on behalf of Fluke. Warranty support is available only if product is purchased through a Fluke authorized sales outlet or Buyer has paid the applicable international price. Fluke reserves the right to invoice Buyer for importation costs of repair/replacement parts when product purchased in one country is submitted for repair in another country.

Fluke's warranty obligation is limited, at Fluke's option, to refund of the purchase price, free of charge repair, or replacement of a defective product which is returned to a Fluke authorized service center within the warranty period.

To obtain warranty service, contact your nearest Fluke authorized service center to obtain return authorization information, then send the product to that service center, with a description of the difficulty, postage and insurance prepaid (FOB Destination). Fluke assumes no risk for damage in transit. Following warranty repair, the product will be returned to Buyer, transportation prepaid (FOB Destination). If Fluke determines that failure was caused by neglect, misuse, contamination, alteration, accident, or abnormal condition of operation or handling, including overvoltage failures caused by use outside the product's specified rating, or normal wear and tear of mechanical components, Fluke will provide an estimate of repair costs and obtain authorization before commencing the work. Following repair, the product will be returned to the Buyer transportation prepaid and the Buyer will be billed for the repair and return transportation charges (FOB Shipping Point).

**THIS WARRANTY IS BUYER'S SOLE AND EXCLUSIVE REMEDY AND IS IN LIEU OF ALL OTHER WARRANTIES, EXPRESS OR IMPLIED, INCLUDING BUT NOT LIMITED TO ANY IMPLIED WARRANTY OF MERCHANTABILITY OR FITNESS FOR A PARTICULAR PURPOSE. FLUKE SHALL NOT BE LIABLE FOR ANY SPECIAL, INDIRECT, INCIDENTAL OR CONSEQUENTIAL DAMAGES OR LOSSES, INCLUDING LOSS OF DATA, ARISING FROM ANY CAUSE OR THEORY.**

Since some countries or states do not allow limitation of the term of an implied warranty, or exclusion or limitation of incidental or consequential damages, the limitations and exclusions of this warranty may not apply to every buyer. If any provision of this Warranty is held invalid or unenforceable by a court or other decision-maker of competent jurisdiction, such holding will not affect the validity or enforceability of any other provision.

Fluke Corporation	Fluke Europe B.V.
P.O. Box 9090	P.O. Box 1186
Everett, WA 98206-9090	5602 BD Eindhoven
U.S.A.	The Netherlands

# Table of Contents

Chapter	Title	Page
<b>1</b>	<b>Before You Start .....</b>	<b>1-1</b>
1.1	Symbols Used.....	1-1
1.2	Safety Information.....	1-2
1.2.1	Warnings.....	1-2
1.2.2	Cautions.....	1-3
1.3	Authorized Service Centers .....	1-3
<b>2</b>	<b>Introduction .....</b>	<b>2-1</b>
2.1	Features.....	2-1
2.2	Components .....	2-4
2.2.1	Base Microprocessor .....	2-4
2.2.1.1	Display .....	2-4
2.2.1.2	Buttons.....	2-8
2.2.1.3	Serial RS-232 Interface .....	2-9
2.2.1.4	Power Supply.....	2-9
2.2.1.5	Module Bus .....	2-9
2.2.2	Add-On Modules.....	2-9
2.3	Data Processing .....	2-11
2.3.1	Inputs .....	2-11
2.3.2	Sampling Control .....	2-11
2.3.3	Input Average .....	2-11
2.3.4	Temperature Conversion .....	2-11
2.3.5	Unit Conversion .....	2-12
2.3.6	Primary Measurement Display.....	2-13
2.3.7	Graph and Scroll Windows .....	2-13
2.3.8	Memory.....	2-13
2.3.9	Printer Outputs.....	2-13
2.3.10	Statistics .....	2-13
2.3.11	Output Routing.....	2-13
2.3.12	Display Data Fields.....	2-13
2.3.13	Data Output Channels .....	2-13

<b>3</b>	<b>Specifications and Environmental Conditions .....</b>	<b>3-1</b>
3.1	Specifications.....	3-1
3.2	Environmental Conditions.....	3-1
<b>4</b>	<b>General Operation .....</b>	<b>4-1</b>
4.1	Installing New Modules.....	4-1
4.2	AC Power Source .....	4-3
4.3	Power On Self-Test .....	4-3
4.4	Adjusting the Screen Contrast.....	4-3
4.5	Making Measurements .....	4-4
4.5.1	Selecting Input Channels.....	4-4
4.5.2	Selecting the Probe Characterization .....	4-5
4.5.3	Measuring One Channel.....	4-7
4.5.4	Scanning Channels.....	4-7
4.5.5	Displaying Measurement Data.....	4-7
<b>5</b>	<b>Soft-Key Functions .....</b>	<b>5-1</b>
5.1	Input Menu.....	5-1
5.1.1	Measure.....	5-1
5.1.2	Primary Channel .....	5-3
5.1.3	Scan Channels .....	5-4
5.1.4	Scan Mode.....	5-4
5.1.5	Average .....	5-5
5.2	Probe Menu .....	5-5
5.2.1	Edit Probe .....	5-5
5.2.1.1	R( $\Omega$ ) Conversion .....	5-8
5.2.1.2	ITS-90 Conversion.....	5-8
5.2.1.3	W (T <sub>90</sub> ) Conversion .....	5-9
5.2.1.4	IPTS-68 Conversion .....	5-9
5.2.1.5	Calendar-Van Dusen Conversion .....	5-9
5.2.1.6	RTD Polynomial Conversion.....	5-10
5.2.1.7	Thermistor T(R) Conversion .....	5-11
5.2.1.8	Thermistor R(T) Conversion .....	5-11
5.2.1.9	Thermocouple Volts Conversion.....	5-11
5.2.1.10	Standard Thermocouple Conversions .....	5-12
5.2.1.11	Thermocouple Table Conversion.....	5-13
5.2.1.12	Thermocouple Polynomial Conversion .....	5-14
5.2.2	Copy Probe.....	5-15
5.2.3	Test Conversion.....	5-16
5.3	Output Menu .....	5-16
5.3.1	Display Window Menu .....	5-17
5.3.1.1	Statistical Window.....	5-17
5.3.1.2	Set Fields .....	5-17
5.3.1.3	Graph Window .....	5-19
5.3.1.4	Clear Graph .....	5-19
5.3.1.5	Scrolling Window .....	5-19
5.3.2	Output Channel.....	5-20
5.3.3	Print Output.....	5-21
5.3.4	Print Memory .....	5-21
5.3.5	Clear Statistics.....	5-22
5.4	Module Menu .....	5-22
5.4.1	Set Up Screen .....	5-22
5.4.2	Set Up Device.....	5-23
5.4.3	Calibrate Device .....	5-24
5.4.4	Module Information .....	5-25
5.5	System Menu.....	5-26
5.5.1	Units.....	5-26

5.5.2	Time .....	5-27
5.5.3	Password .....	5-27
5.5.4	System Information .....	5-28
5.5.5	System Reset .....	5-29
<b>6</b>	<b>Digital Communications Interface .....</b>	<b>6-1</b>
6.1	Overview .....	6-1
6.2	Serial Interface .....	6-1
6.3	Command Syntax .....	6-2
6.4	Command Summary .....	6-3
6.5	Commands .....	6-3
6.5.1	Measurement Data Commands .....	6-3
6.5.1.1	CALCulate[n]:AVERage[n]:CLEar .....	6-3
6.5.1.2	CALCulate[n]:AVERage[n]:CLEar:ALL .....	6-8
6.5.1.3	CALCulate[n]:AVERage[n]:DATA? .....	6-8
6.5.1.4	CALCulate[n]:AVERage[n]:STATe? .....	6-9
6.5.1.5	CALCulate[n]:AVERage[n]:TYPE? .....	6-9
6.5.1.6	CONFigure[ < channel >] .....	6-9
6.5.1.7	CONFigure? .....	6-10
6.5.1.8	DATA[:DATA]:VALue? [MEM,] < numeric_value > .....	6-10
6.5.1.9	DATA:POINts? [MEM] .....	6-10
6.5.1.10	FETCh[:TEMPerature]? [ < channel >] .....	6-11
6.5.1.11	MEASure[:TEMPerature]? [ < channel >] .....	6-11
6.5.1.12	READ[:TEMPerature]? .....	6-12
6.5.1.13	SENSe[n]:AVERage:DATA? .....	6-12
6.5.2	Measurement Control Commands .....	6-12
6.5.2.1	ABORt .....	6-12
6.5.2.2	INITiate[:IMMediate] .....	6-12
6.5.2.3	INITiate:CONTInuous < Boolean > .....	6-13
6.5.2.4	INITiate:CONTInuous? .....	6-13
6.5.2.5	SENSe:AVERage:COUNt < numeric_value > .....	6-14
6.5.2.6	SENSe:AVERage:COUNt? .....	6-14
6.5.2.7	SENSe:AVERage[:STATe] < Boolean > .....	6-14
6.5.2.8	SENSe: AVERage[:STATe]? .....	6-14
6.5.2.9	TRIGger[:SEQUence]:COUNt < numeric_value > .....	6-14
6.5.2.10	TRIGger[:SEQUence]:COUNt? .....	6-15
6.5.2.11	TRIGger[:SEQUence]:DELay < numeric_value > .....	6-15
6.5.2.12	TRIGger[:SEQUence]:DELay? .....	6-15
6.5.2.13	TRIGger[:SEQUence]:TIMer < numeric_value > .....	6-15
6.5.2.14	TRIGger[:SEQUence]:TIMer? .....	6-15
6.5.3	Input Channel Commands .....	6-15
6.5.3.1	ROUTe:CLOSe < channel > .....	6-16
6.5.3.2	ROUTe:CLOSe:STATe? .....	6-16
6.5.3.3	ROUTe:PRIMary? .....	6-16
6.5.3.4	ROUTe:SCAN:ALTErnate < Boolean > .....	6-16
6.5.3.5	ROUTe:SCAN:ALTErnate? .....	6-16
6.5.3.6	ROUTe:SCAN[:LIST] < channel_list > .....	6-16
6.5.3.7	ROUTe:SCAN[:LIST]? .....	6-17
6.5.3.8	ROUTe:SCAN:STATe < Boolean > .....	6-17
6.5.3.9	ROUTe:SCAN:STATe? .....	6-17
6.5.4	Probe Commands .....	6-17
6.5.4.1	CALCulate[n]:CONVert:CATalog? .....	6-18
6.5.4.2	CALCulate[n]:CONVert:COPIY < channel > .....	6-20
6.5.4.3	CALCulate[n]:CONVert:DATA? .....	6-20
6.5.4.4	CALCulate[n]:CONVert:NAME < conversion_name > .....	6-20
6.5.4.5	CALCulate[n]:CONVert:NAME? .....	6-22
6.5.4.6	CALCulate[n]:CONVert:PARAmeter:CATalog? .....	6-22

6.5.4.7	CALCulate[n]:CONVert:PARAmeter:VALue < parameter_name >, < numeric_value >[, < parameter_name >, < numeric_value > . . . ].....	6-22
6.5.4.8	CALCulate[n]:CONVert:PARAmeter:VALue? < parameter_name > .....	6-23
6.5.4.9	CALCulate[n]:CONVert:PARAmeter:VALue? ALL .....	6-23
6.5.4.10	CALCulate[n]:CONVert:SNUMber < serial_number > .....	6-23
6.5.4.11	CALCulate[n]:CONVert:SNUMber? .....	6-23
6.5.4.12	CALCulate[n]:CONVert:SRLow < sub-range_number > ....	6-23
6.5.4.13	CALCulate[n]:CONVert:SRLow? .....	6-24
6.5.4.14	CALCulate[n]:CONVert:SRHigh < sub-range_number > ...	6-24
6.5.4.15	CALCulate[n]:CONVert:SRHigh?.....	6-24
6.5.4.1	CALCulate[n]:CONVert:TEST? < numeric_value > [, < numeric_value >] .....	6-24
6.5.5	Output Channel Commands .....	6-25
6.5.5.1	OUTPut[n]:CALC < numeric_value > .....	6-25
6.5.5.2	OUTPut[n]:CALC? .....	6-25
6.5.5.3	OUTPut[n]:NCHannel < channel >.....	6-26
6.5.5.4	OUTPut[n]:NCHannel? .....	6-26
6.5.5.5	OUTPut[n]:PCHannel < channel >.....	6-27
6.5.5.6	OUTPut[n]:PCHannel? .....	6-27
6.5.5.7	OUTPut[n]:STATe] < Boolean > .....	6-27
6.5.5.8	OUTPut[n]:STATe]? .....	6-27
6.5.6	Printer Commands .....	6-28
6.5.6.1	HCOPy:ABORt .....	6-28
6.5.6.2	HCOPy[:IMMediate] < printer_number >, < numeric_value > .....	6-28
6.5.6.3	HCOPy:PRINter[n]:STATe] < Boolean > .....	6-28
6.5.6.4	HCOPy:PRINter[n]:STATe]? .....	6-29
6.5.7	Communication Interface Commands .....	6-29
6.5.7.1	SYSTem:COMMunicate:SERial[:RECEive]: BAUD <numeric_value> .....	6-29
6.5.7.2	SYSTem:COMMunicate:SERial[:RECEive]:BAUD? .....	6-29
6.5.7.3	SYSTem:COMMunicate:SERial[:RECEive]:FDUPlex < Boolean >.....	6-29
6.5.7.4	SYSTem:COMMunicate:SERial[:RECEive]:FDUP?.....	6-30
6.5.7.5	SYSTem:COMMunicate:SERial[:RECEive]:LINefeed <Boolean> .....	6-30
6.5.7.6	SYSTem:COMMunicate:SERial[:RECEive]:LINefeed? .....	6-30
6.5.8	Module Commands .....	6-30
6.5.8.1	SYSTem:CONFIgure:CDEvice? .....	6-31
6.5.8.2	SYSTem:CONFIgure:COMMunicate[n]:DADdress? .....	6-32
6.5.8.3	SYSTem:CONFIgure:COMMunicate[n]:MADdress? .....	6-32
6.5.8.4	SYSTem:CONFIgure:ICHannel? .....	6-32
6.5.8.5	SYSTem:CONFIgure:IDevice? .....	6-32
6.5.8.6	SYSTem:CONFIgure:INPut[n]:DADdress? .....	6-32
6.5.8.7	SYSTem:CONFIgure:INPut[n]:MADdress? .....	6-33
6.5.8.8	SYSTem:CONFIgure:MNUMber? .....	6-33
6.5.8.9	SYSTem:CONFIgure:MODule[n]:DEvice[n]:INformation? .....	6-33
6.5.8.10	SYSTem:CONFIgure:MODule[n]:DNUMber? .....	6-33
6.5.8.11	SYSTem:CONFIgure:MODule[n]:INformation? .....	6-34
6.5.8.12	SYSTem:CONFIgure:OCHannel?.....	6-34
6.5.8.13	SYSTem:CONFIgure:ODEvice?.....	6-34
6.5.8.14	SYSTem:CONFIgure:OUTPut[n]:DADdress? .....	6-34
6.5.8.15	SYSTem:CONFIgure:OUTPut[n]:MADdress? .....	6-34
6.5.8.16	SYSTem:CONFIgure:PDEvice? .....	6-35

6.5.8.17	SYSTem:CONFigure:PRINter[n]:DADDRESS?.....	6-35
6.5.8.18	SYSTem:CONFigure: PRINter[n]:MADDRESS? .....	6-35
6.5.8.19	SYSTem:MODUle[n]:DEVice[n]:READ? < device_command >.....	6-35
6.5.8.20	SYSTem:MODUle[n]:DEVice[n]:WRITE < device_command >, < value > .....	6-36
6.5.9	System Commands .....	6-36
6.5.9.1	*IDN? .....	6-37
6.5.9.2	*OPT? .....	6-37
6.5.9.3	*RST .....	6-37
6.5.9.4	SYSTem:DATE < year >, < month >, < day > .....	6-38
6.5.9.5	SYSTem:DATE? .....	6-38
6.5.9.6	SYSTem:SNUMber < serial_number > .....	6-38
6.5.9.7	SYSTem:SNUMber? .....	6-38
6.5.9.8	SYSTem:TIME < hour >, < minute >, < second > .....	6-38
6.5.9.9	SYSTem:TIME? .....	6-38
6.5.9.10	SYSTem:VERSion? .....	6-39
6.5.9.11	UNIT:TEMPerature <unit> .....	6-39
6.5.9.12	UNIT:TEMPerature? .....	6-39
6.5.10	Status Commands .....	6-39
6.5.10.1	*CLS .....	6-39
6.5.10.2	*ESE < numeric_value > .....	6-40
6.5.10.3	*ESE? .....	6-40
6.5.10.4	*ESR? .....	6-40
6.5.10.5	*OPC .....	6-41
6.5.10.6	*OPC? .....	6-41
6.5.10.7	*SRE < numeric_value > .....	6-42
6.5.10.8	*SRE? .....	6-42
6.5.10.9	*STB? .....	6-42
6.5.10.10	*TST? .....	6-43
6.5.10.11	*WAI .....	6-43
6.5.10.12	STATus:OPERation:CONDition? .....	6-43
6.5.10.13	STATus:OPERation:ENABLE < numeric_value > .....	6-44
6.5.10.14	STATus:OPERation:ENABLE? .....	6-44
6.5.10.15	STATus:OPERation[:EVENT]? .....	6-44
6.5.10.16	STATus:PRESet .....	6-44
6.5.10.17	STATus:QUEStionable:CONDition? .....	6-45
6.5.10.18	STATus:QUEStionable:ENABLE < numeric_value > .....	6-45
6.5.10.19	STATus:QUEStionable:ENABLE? .....	6-45
6.5.10.20	STATus:QUEStionable[:EVENT]? .....	6-45
6.5.10.21	STATus:QUEue[:NEXT]? .....	6-45
6.5.10.22	SYSTem:ERRor? .....	6-46
6.6	Programming Example .....	6-47
<b>7</b>	<b>2560/2567 SPRT Module .....</b>	<b>7-1</b>
7.1	Description .....	7-1
7.2	Specifications .....	7-1
7.3	Operation .....	7-2
7.3.1	Connecting a Probe .....	7-2
7.3.2	Setting Coefficients .....	7-3
7.3.3	Current .....	7-3
7.3.4	Device Setup Commands .....	7-4
7.4	Calibration .....	7-4
7.4.1	Calibration Parameters .....	7-4
7.4.2	Front-panel Access .....	7-5
7.4.3	Calibration Procedure (2560) .....	7-6
7.4.4	Calibration Procedure (2567) .....	7-6

<b>8</b>	<b>2561 HTPRT Module .....</b>	<b>8-1</b>
8.1	Description.....	8-1
8.2	Specifications.....	8-1
8.3	Operation .....	8-2
8.3.1	Connecting a Probe .....	8-2
8.3.2	Setting Coefficients.....	8-3
8.3.3	Current.....	8-3
8.3.4	Device Setup Commands .....	8-3
8.4	Calibration.....	8-4
8.4.1	Calibration Parameters .....	8-4
8.4.2	Front-panel Access.....	8-4
8.4.3	Calibration Procedure .....	8-6
<b>9</b>	<b>2562/2568 PRT Scanner Module .....</b>	<b>9-1</b>
9.1	Description.....	9-1
9.2	Specifications.....	9-2
9.3	Operation .....	9-3
9.3.1	Wire Configuration .....	9-3
9.3.2	Connecting a Probe .....	9-4
9.3.3	Setting Coefficients.....	9-4
9.3.4	Current.....	9-5
9.3.5	Device Setup Commands .....	9-5
9.4	Calibration.....	9-6
9.4.1	Calibration Parameters .....	9-6
9.4.2	Front-Panel Access .....	9-6
9.4.3	Calibration Procedure (2562).....	9-7
9.4.4	Calibration Procedure (2568).....	9-7
<b>10</b>	<b>2563 Thermistor Module .....</b>	<b>10-1</b>
10.1	Description.....	10-1
10.2	Specifications.....	10-1
10.3	Operation .....	10-2
10.3.1	Connecting a Thermistor .....	10-2
10.3.2	Setting Coefficients.....	10-3
10.3.3	Current.....	10-3
10.3.4	Device Setup Commands .....	10-4
10.4	Calibration.....	10-4
10.4.1	Calibration Parameters .....	10-4
10.4.2	Front-panel Access.....	10-5
10.4.3	Calibration Procedure .....	10-6



<b>11</b>	<b>2564 Thermistor Scanner Module</b> .....	<b>11-1</b>
	11.1 Description .....	11-1
	11.2 Specifications .....	11-1
	11.3 Operation .....	11-2
	11.3.1 Wire Configuration .....	11-2
	11.3.2 Connecting a Probe .....	11-3
	11.3.3 Setting Coefficients .....	11-3
	11.3.4 Current .....	11-4
	11.3.5 Device Setup Commands .....	11-4
	11.4 Calibration .....	11-5
	11.4.1 Calibration Parameters .....	11-5
	11.4.2 Front-Panel Access .....	11-6
	11.4.3 Calibration Procedure .....	11-6
<b>12</b>	<b>2565 Precision Thermocouple Module</b> .....	<b>12-1</b>
	12.1 Description .....	12-1
	12.2 Specifications .....	12-2
	12.2.1 Calculating Accuracy .....	12-3
	12.3 Operation .....	12-3
	12.3.1 Connecting a Thermocouple .....	12-4
	12.3.2 Selecting the Thermocouple Type .....	12-4
	12.3.3 Selecting the CJC Type .....	12-4
	12.3.4 Using Calibrated Thermocouples .....	12-5
	12.3.5 Suggestions for Optimum Accuracy .....	12-6
	12.3.5.1 Warm-up Time .....	12-6
	12.3.5.2 Ambient Environment .....	12-6
	12.3.5.3 Thermal Settling .....	12-6
	12.3.5.4 Ground Currents .....	12-6
	12.3.6 Setup Parameters .....	12-6
	12.4 Calibration .....	12-6
	12.4.1 Calibration Parameters .....	12-6
	12.4.2 Front-Panel Access .....	12-7
	12.4.3 Calibration Procedure .....	12-7
<b>13</b>	<b>2566 Thermocouple Scanner Module</b> .....	<b>13-1</b>
	13.1 Description .....	13-1
	13.2 Specifications .....	13-1
	13.2.1 Calculating Accuracy .....	13-2
	13.3 Operation .....	13-2
	13.3.1 Connecting a Thermocouple .....	13-2
	13.3.2 Selecting the Thermocouple Type .....	13-3
	13.3.3 Selecting the CJC Type .....	13-3
	13.3.4 Using Calibrated Thermocouples .....	13-3
	13.3.5 Suggestions for Optimum Accuracy .....	13-4
	13.3.5.1 Warm-up Time .....	13-4
	13.3.5.2 Ambient Environment .....	13-4
	13.3.5.3 Thermal Settling .....	13-4
	13.3.6 Setup Parameters .....	13-4
	13.4 Calibration .....	13-5
	13.4.1 Calibration Parameters .....	13-5
	13.4.2 Front-Panel Access .....	13-6
	13.4.3 Calibration Procedure .....	13-6

---

<b>14</b>	<b>3560 Extended Communication Module.....</b>	<b>14-1</b>
14.1	Description.....	14-1
14.2	Specifications.....	14-1
14.3	Installation.....	14-1
14.4	GPIB Communication Device .....	14-2
14.4.1	Capability .....	14-3
14.4.2	Connection.....	14-3
14.4.3	Device Setup .....	14-3
14.4.4	Commands .....	14-4
14.4.5	Serial Poll.....	14-4
14.4.6	Device Clear .....	14-4
14.4.7	Device Setup Commands .....	14-5
14.5	Serial Communication Device.....	14-5
14.5.1	Connection.....	14-5
14.5.2	Device Setup .....	14-6
14.5.3	Commands .....	14-6
14.5.4	Device Setup Commands .....	14-7
14.6	Serial Printer Device .....	14-7
14.6.1	Device Setup .....	14-7
14.6.2	Printing Measurement Data .....	14-8
14.6.3	Device Setup Commands .....	14-8
14.7	Parallel Printer Device .....	14-9
14.7.1	Connection.....	14-9
14.7.2	Device Setup .....	14-9
14.7.3	Printing Measurement Data .....	14-10
14.7.4	Device Setup Commands .....	14-10
14.8	Analog Output Device.....	14-11
14.8.1	Connection.....	14-11
14.8.2	Device Setup .....	14-11
14.8.3	Selecting Data .....	14-12
14.8.4	Calibration.....	14-12
14.8.5	Device Setup Commands .....	14-13
<b>15</b>	<b>Maintenance.....</b>	<b>15-1</b>
<b>16</b>	<b>Troubleshooting .....</b>	<b>16-1</b>
16.1	Incorrect Temperature Reading.....	16-1
16.2	Incorrect Resistance or Voltage Reading .....	16-2
16.3	Communication Difficulties .....	16-2
16.4	Blank Screen .....	16-3
16.5	Error Message at Power Up .....	16-3
16.6	CE Comments .....	16-4
16.6.1	EMC Directive.....	16-4
16.6.1.1	Immunity Testing .....	16-4
16.6.1.2	Emission Testing .....	16-4
16.6.2	Low Voltage Directive (Safety) .....	16-4

# List of Tables

Table	Title	Page
1.	International Electrical Symbols .....	1-1
2.	Soft-key Menu System .....	5-2
3.	Conversion Types .....	5-7
4.	CALCULATION option. ....	5-18
5.	Command Summary .....	6-4
5.	Command Summary Continued .....	6-5
5.	Command Summary Continued .....	6-6
5.	Command Summary Continued .....	6-7
6.	Measurement Data Commands .....	6-8
7.	Statistical Calculation Types .....	6-9
8.	Measurement Control Commands .....	6-13
9.	Input Channel Commands.....	6-15
10.	Probe Command Summary.....	6-18
11.	Conversion Type Mnemonics.....	6-19
12.	Conversion Parameters.....	6-21
13.	Output Channel Commands.....	6-25
14.	Output Calculation Types .....	6-26
15.	Printer Commands .....	6-28
16.	Communication Interface Commands.....	6-30
17.	Module Commands .....	6-31
18.	System Commands .....	6-36
19.	Status Commands.....	6-41
20.	SPRT Module Device Commands.....	7-4
21.	HTPRT Module Device Commands .....	8-4
22.	PRT Scanner Commands .....	9-5
23.	Thermistor Module Device Commands .....	10-4
24.	Thermistor Scanner Module Commands.....	11-5
25.	Precision Thermocouple Module calibration parameters .....	12-7
26.	Thermocouple Scanner Module calibration parameters.....	13-5
27.	3560 Specifications .....	14-2
28.	GPIB Communications Device Commands.....	14-5
29.	Serial Communication Device Commands.....	14-7
30.	Serial Printer Device Commands .....	14-9
31.	Parallel Printer Device Commands .....	14-10
32.	Analog Output Device Commands .....	14-13



# ***List of Figures***

<b>Figure</b>	<b>Title</b>	<b>Page</b>
1.	1560 Black Stack Thermometer with Two Modules Attached .....	2-2
2.	System Diagram.....	2-5
3.	Typical Display .....	2-6
4.	Typical graph mode display.....	2-7
5.	Data Flow .....	2-11
6.	Attaching New Modules.....	4-2
7.	Channel Numbering .....	4-4
8.	Typical Statistical Display .....	5-15
9.	Typical Graph Window Display .....	5-17
10.	Typical Scrolling Display .....	5-17
11.	RS-232 Cable Wiring.....	6-1
12.	Programming Example .....	6-45
13.	Sensor Wiring Diagram .....	7-3
14.	Sensor Wiring Diagram .....	8-3
15.	PRT Scanner Module Sensor Wiring Detail .....	9-3
16.	Sensor Wiring Diagram .....	10-3
17.	Thermistor Scanner Module Sensor Wiring Detail .....	11-3
18.	2565 Module Thermocouple Receptacle Operation.....	12-5













# Chapter 1 Before You Start

## 1.1 Symbols Used

Table 1 lists the International Electrical Symbols. Some or all of these symbols may be used on the instrument or in this manual.

**Table 1. International Electrical Symbols**

Symbol	Description
~	AC
≈	AC-DC
	Battery
CE	CE
≡	DC
	Double Insulated
	Electric Shock
	Fuse
	PE Ground
	Hot Surface
	Read the User's Manual
○	Off
⏻	On
	Canadian Standards Association

<b>CATII</b>	OVERVOLTAGE (Installation) CATEGORY II, Pollution Degree 2 per IEC1010-1 refers to the level of Impulse Withstand Voltage protection provided. Equipment of OVERVOLTAGE CATEGORY II is energy-consuming equipment to be supplied from the fixed installation. Examples include household, office, and laboratory appliances.
 N10140	C-TIC Australian EMC
	The European Waste Electrical and Electronic Equipment (WEEE) Directive (2002/96/EC) mark.

## 1.2 Safety Information

Use this instrument only as specified in this manual. Otherwise, the protection provided by the instrument may be impaired. Refer to the safety information in Warnings and Cautions.

The following definitions apply to the terms “Warning” and “Caution”.

- “Warning” identifies conditions and actions that may pose hazards to the user.
- “Caution” identifies conditions and actions that may damage the instrument being used.

### 1.2.1 Warnings

#### Warning

- **DO NOT use this unit in environments other than those listed in the User’s Guide.**
- **Follow all safety guidelines listed in the User’s Guide. Calibration equipment should only be used by trained personnel. This instrument can measure extreme temperatures. Precautions must be taken to prevent personal injury or damage to objects. Probes may be extremely hot or cold. Cautiously handle probes to prevent personal injury. Carefully place probes on a heat/cold resistant surface or rack until they reach room temperature.**
- **DO NOT use this instrument in combination with any probe (PRT, thermistor, or thermocouple) to measure the temperature or resistance of any device where the probe might come in contact with a conductor that is electrically energized. Severe electric shock, personal injury, or death may occur.**



## 1.2.2 Cautions

### Caution

- The instrument and thermometer probes are sensitive and can be easily damaged. Always handle these devices with care. **DO NOT** allow them to be dropped, struck, stressed, or overheated.
- Probes are fragile devices which can be damaged by mechanical shock, over-heating, and absorption of moisture or fluids in the wires or hub. Damage may not be visibly apparent but nevertheless can cause drift, instability, and loss of accuracy. Observe the following precautions:
- **DO NOT** allow probes to be dropped, struck, bent, or stressed.
- **DO NOT** overheat probes beyond their recommended temperature range.
- **DO NOT** allow any part of the probe other than the sheath to be immersed in fluid.
- **DO NOT** allow the probe hub or wires to be exposed to excessive temperatures.
- Keep the probe wires clean and away from fluids.

## 1.3 Authorized Service Centers

Please contact one of the following authorized Service Centers to coordinate service on your Fluke Calibration product:

### **Fluke Corporation, Hart Scientific Division**

799 E. Utah Valley Drive  
American Fork, UT 84003-9775  
USA  
Phone: +1.801.763.1600  
Telefax: +1.801.763.1010  
E-mail: support@hartscientific.com

### **Fluke Nederland B.V.**

Customer Support Services  
Science Park Eindhoven 5108  
5692 EC Son  
NETHERLANDS  
Phone: +31-402-675300  
Telefax: +31-402-675321  
E-mail: ServiceDesk@fluke.nl

**Fluke Int'l Corporation**

Service Center - Instrimpex  
Room 2301 Sciteck Tower  
22 Jianguomenwai Dajie  
Chao Yang District  
Beijing 100004, PRC  
CHINA  
Phone: +86-10-6-512-3436  
Telefax: +86-10-6-512-3437  
E-mail: xingye.han@fluke.com.cn

**Fluke South East Asia Pte Ltd.**

Fluke ASEAN Regional Office  
Service Center  
60 Alexandra Terrace #03-16  
The Comtech (Lobby D)  
118502  
SINGAPORE  
Phone: +65 6799-5588  
Telefax: +65 6799-5588  
E-mail: antng@singa.fluke.com

When contacting these Service Centers for support, please have the following information available:

- Model
- Number
- Serial Number
- Voltage
- Complete description of the problem

## **Chapter 2**

# **Introduction**

This first section describes the 1560 Black Stack in general. Unique features of the 1560 are explained in the first sub-section. Following sub-sections describe the components of the 1560 and the measurement process in greater detail.

### **2.1 Features**

The 1560 Black Stack has a unique modular design that consists of a base controller and add-on modules. The base controller is the “brain” of the system. It directs all operations and provides control signals and power for the modules. The modules are the appendages that give the system the ability to measure temperature and communicate with other instruments. Different modules can have different functions. One module may measure platinum resistance thermometers (PRTs) while another may measure thermocouples. Still another module may provide an interface to a printer. Modules may have more than one independent function or device. For example, a single module may include a GPIB communications device and a Centronics printer interface device. A single device, such as a thermocouple scanner, may also contain multiple channels. By adding certain modules together, an instrument can be assembled with extraordinary capabilities.



**Figure 1. 1560 Black Stack Thermometer with Two Modules Attached**

Every add-on module conforms to specific physical and electrical requirements. This allows any module to be easily connected to the system. Up to eight modules can be stacked onto the base. Modules can be purchased at any time and installed quickly and easily in the field allowing the system to grow as needs arise. The base controller automatically recognizes attached modules. New channels and functions immediately become available.

Each add-on module is an independent intelligent instrument. Modules contain their own microcontroller, memory, and analog-to-digital converter, if necessary. Communication between modules and the base uses a proprietary high-speed digital bus. Modules are calibrated individually with calibration parameters stored in non-volatile memory within the module.

The physical layout of the 1560 Black Stack is optimized for user convenience. The front panel is tilted for clear viewing of the display and easy access to the buttons. Measurements are displayed with large easy-to-read numbers. Brightness and contrast of the screen are adjustable. The graphics LCD display is able to show a large amount of information and can be configured for different uses. In its statistical window mode, the display can simultaneously show measurements from different channels. It can also show the results of statistical analysis of these measurements. In graph mode, the display shows a plot of measurements over time. Operation of the 1560 is made simple and intuitive with the use of soft-keys. The functions of the five soft-keys are indicated on the graphics display and change depending on the selected menu.

The primary purpose of the 1560 Black Stack is to measure temperature. Typically, it will be fitted with modules that allow it to measure with certain types of sensors such as PRTs or thermocouples. Since many modules can be attached, each having many channels, the system may have a large number and variety of input channels. The base controller is capable of recognizing up to 96 input channels. The base can be programmed to measure one channel continuously or scan many channels automatically. It can also be programmed to acquire a certain number of measurements then stop. Measurements can be stored in memory and printed later.

The 1560 Black Stack is designed to measure a variety of sensors: platinum resistance thermometers (PRTs) or resistance temperature detectors (RTDs), standard platinum resistance thermometers (SPRTs), thermistors, thermocouples, and others. The base controller is able to mathematically convert measurements of resistance or volts to temperature using any of the standard algorithms. With PRTs, RTDs, and SPRTs, temperature can be calculated according to ITS-90, IPTS-68, Callendar-Van Dusen, or a polynomial. Probe-specific characterization coefficients are accepted for calibrated sensors. With thermistors, temperature can be calculated according to the Steinhart-Hart equation or a polynomial with user-specified coefficients. With thermocouples, temperature is calculated according to the standard tables for type B, E, J, K, N, R, S, T, and gold-platinum thermocouples as well as a polynomial or user-specified table. Adjustments to the standard curve can be made for improved accuracy. Thermocouples can be used with internal or external cold-junction compensation. Characterizations are independently chosen for each sensor channel. Temperature can be displayed in units of degrees Celsius, degrees Fahrenheit, or Kelvin.

The temperature conversion algorithms and characterization coefficients can be easily tested. You can enter arbitrary resistances or voltages and the corresponding temperature is immediately displayed.

In addition to simple temperature measurements, the 1560 will calculate and display statistical results that include: average, standard deviation, maximum, minimum, and spread. It will also display differences between measurements of any two channels. The 1560 can send measurement results to printer ports, communication ports, and output channels provided by modules.

The 1560 has a built-in clock. This not only allows the display to show the current time-of-day but allows each measurement to be stamped with the time. Measurements are printed with the time and date.

The 1560 is designed for operation not only with the front panel buttons but also using any of a variety of digital communication interfaces. The base controller includes one built-in serial RS-232 port. IEEE-488 (GPIB) is available with an add-on module. Communication interfaces allow the 1560 to accept commands to perform a variety of useful functions. Using the serial or GPIB interface, a remote instrument or computer can control the acquisition of measurements and read back measurement data.

## **2.2 Components**

Figure 2 shows the system layout of the 1560 Black Stack. The components are described in the following sections.

### **2.2.1 Base Microprocessor**

The base microprocessor is the main controller of the system. It controls the display, buttons, serial interface, and flow of data through the module bus. It also performs temperature and statistical calculations. The microprocessor operates from firmware contained in read-only memory (ROM). It uses random-access memory (RAM) to store measurements and other data temporarily. Data that must be preserved, even when the power is off, are stored in non-volatile RAM.

#### **2.2.1.1 Display**

The front-panel LCD graphics display allows the user to view measured data as well as a variety of other important information. It also helps the user select functions using the soft-keys. Figure 3 shows an example of how the display might look. The various parts of the display are described following.

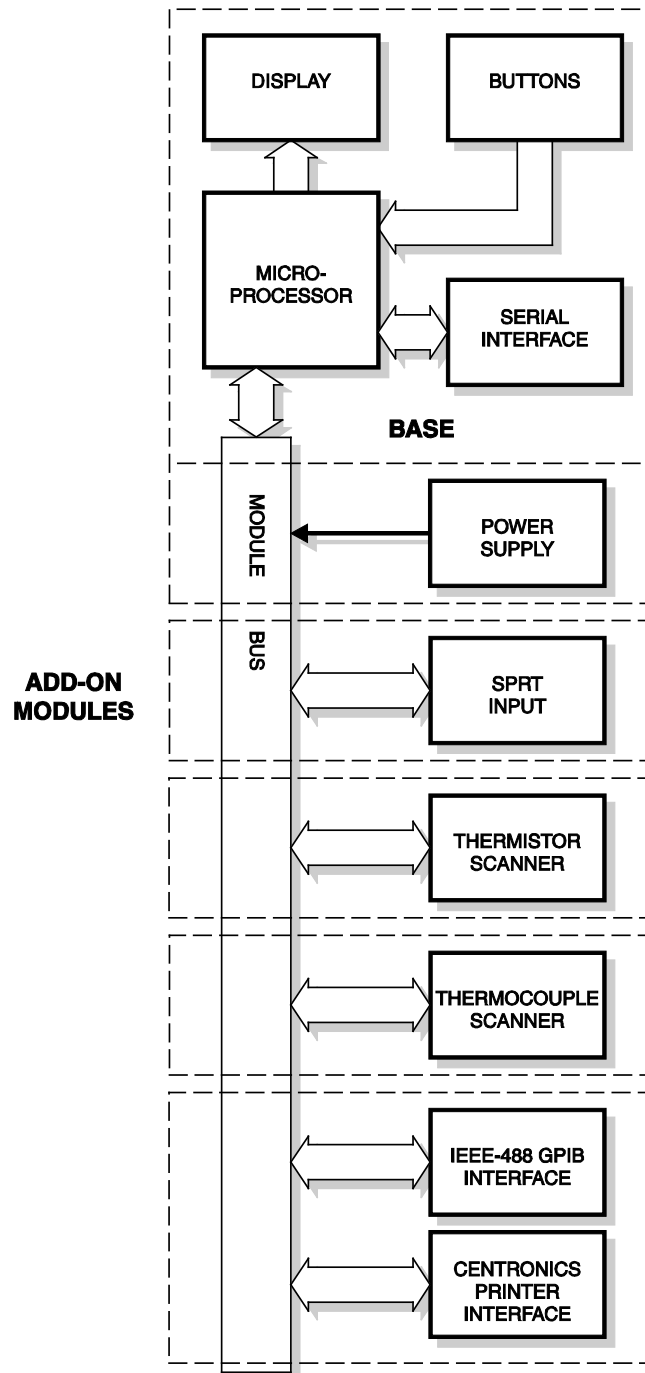

Figure 2. System Diagram

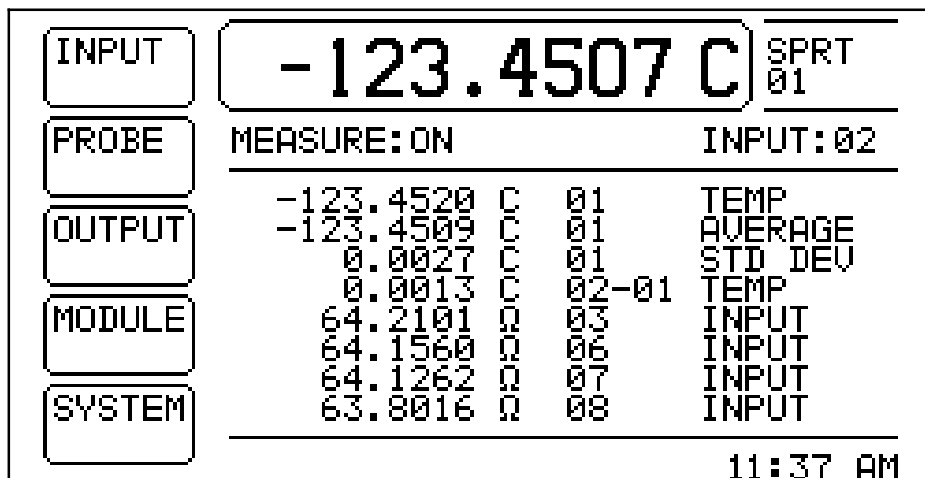

Figure 3. Typical Display

### Primary display window

The primary display window presents the most recent measurement. It is located at the top-center of the screen as shown in Figure 3. It displays numbers with up to ten digits. The unit of measurement is shown to the right of the measurement value. With some measurements a multiplier such as  $\mu$ , m, k, or M may appear in front of the unit character. The area to the right of the primary display window indicates the input channel of the displayed measurement. The channel is identified by device name and channel number.

### Measurement status

The area immediately below the primary display window shows the status of the current measurement. The measurement mode is shown after "MEASURE:". This will be "OFF" if measuring is disabled, "ON" if measuring is continuous, or the measurement count if the measurement mode is COUNT (see Section 5.1.1). The input channel number of the measurement in process is indicated on the right after "INPUT:"

### Time

The time is displayed at the bottom right corner of the screen as shown in Figure 3. The time is displayed in 12-hour format (1–12 hours) with hours, minutes, and "AM" or "PM". The time is maintained even when power is off. You are able to set the time and date (see Section 5.5.2).

### Soft-keys

Five soft-key labels are located along the left edge of the display next to the soft-key buttons. The soft-key labels and the functions of the soft-key buttons change depending on the selected menu.



### Statistical display window

The large area in the center of the display has various uses. Figure 3 shows how the center window appears in statistical mode. With this mode, the window contains eight data fields that show the values of various measurements (see Section 5.3.1.1 and 5.3.1.2). Each data field displays a measurement with the value first, then the units, then the channel (or pair of channels for differential calculations), and finally a label showing the type of calculation.

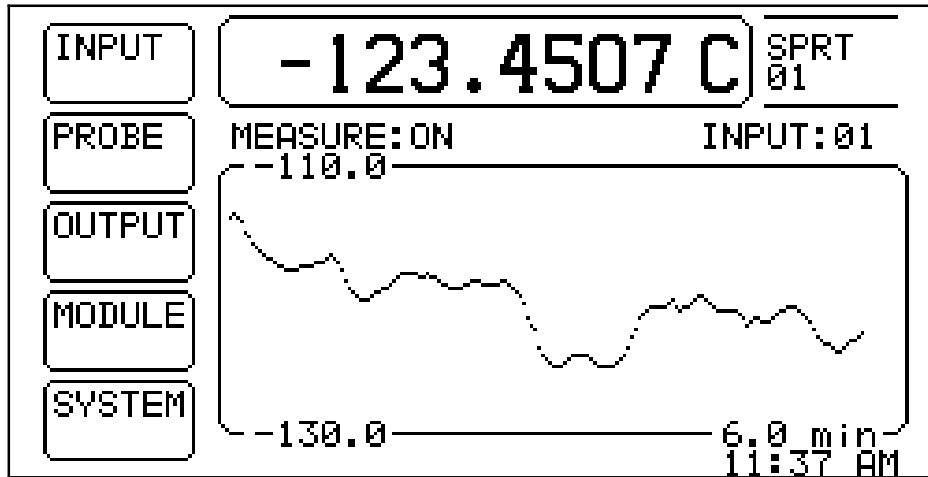

Figure 4. Typical graph mode display

### Graph mode display window

Figure 4 shows how the center window appears in graph mode. With this mode, the window shows a graph of the most recent measurements versus time (see Section 5.3.1.3). The upper and lower limits of the vertical axis are shown at the top and bottom on the left side of the window. The vertical scale adjusts automatically to best fit the data. The horizontal time scale is shown at the bottom on the right. The time scale is determined by the measurement DELAY setting (see Section 5.1.1).

### Scroll mode display window

In scroll mode, the center window of the display acts as a terminal screen displaying the most recent measurements. Each time a new measurement is produced and displayed on the screen in the primary display window it is also displayed on the top of the text output window (see Section 5.3.1.5). Each line containing previous measurements is scrolled down one line. Measurements are displayed with the input channel number first, then the measurement value, the units, and the time the measurement was acquired. The time is displayed in 24-hour format (0–23 hours) with hours, minutes, and seconds.

### Function window

When using the soft-key functions, the center window may temporarily be used to show specific information. In conjunction with the numeric and arrow buttons, it can be used to set parameters.

### 2.2.1.2 Buttons

The buttons are used to select functions and edit parameters. The functions of the various buttons are described below.

#### Soft-keys



The five soft-keys to the left of the display are used to select menus or menu functions. The functions of the soft-keys are indicated by the soft-key labels on the display next to the soft-keys. The functions of the soft-keys depend on the selected menu. Soft-key functions are explained in detail in Section 5.

#### Numeric keys

The ten digit keys, the decimal point (.), minus (–), and exponent (EXP) keys are used to type in numeric data or make numbered selections.

#### ENTER



The **ENTER** key, , is used to enter a new parameter value or option. Generally, when the value of any parameter is changed, **ENTER** must be pressed to accept the new value. If **EXIT**,  or , is pressed before **ENTER**, any data entered will be ignored and the parameter will remain at its previous value. Within a window with a list of parameters, pressing **ENTER** will also move the cursor down to the next parameter. If the cursor is at the bottom of the list, pressing **ENTER** without changing the parameter will exit the window. The **ENTER** button may be used during some operations to affirm or continue with an action or choice.





#### DEL

When entering or editing a numeric parameter, the **DEL** (delete) key is used to delete a digit that is highlighted by the cursor.



#### EXIT

The **EXIT** key is used to cancel an operation, exit a window, or return from a lower menu to a higher menu. In any window, pressing **EXIT** will immediately exit the window and skip to the next window or return to the menu. If a parameter is entered or changed and **EXIT** is pressed before **ENTER**, the change will be ignored. During some operations the **EXIT** button may be used to cancel or discontinue with an action or choice. Use **EXIT** when in a lower soft-key menu to return to the main menu.



The up  and down  arrow keys are used to move the cursor through a list of parameters in a window. Note that new data will not be accepted unless ENTER is pressed first. Thus these keys can also be used to intentionally cancel a change to a parameter. If the list of parameters is too long to be displayed in the window,  and  can be used to scroll the list. The user can hold either of these down to scroll quickly.



The left  and right  arrow keys have two functions. When entering or editing a numeric parameter these can be used to move from digit to digit. When setting some parameters these are used to change the option.



These are the display contrast adjustment buttons. They can be used at any time to adjust the contrast of the display.

### **2.2.1.3 Serial RS-232 Interface**

The base includes an RS-232 serial interface. The connector is located on the bottom at the rear of the front section of the base. This can be used to connect the 1560 to a printer for a hard copy printout of measurement data or to a computer for remote control.

### **2.2.1.4 Power Supply**

The power supply provides the DC power required for the electronic circuits. It receives power from the AC mains supply. The AC power socket is located at the bottom at the rear of the second section of the base. The power supply input accepts 100 to 250V, 50 to 60 Hz. nominal AC power.

### **2.2.1.5 Module Bus**

The base microprocessor communicates with all add-on modules and devices through the module bus. The bus is of a proprietary design that is simple, reliable, and fast. It transfers data very quickly in an 8-bit parallel format. The module bus also supplies power to the modules.

## **2.2.2 Add-On Modules**

Add-on modules provide specific functionality required by the user. Up to eight modules can be attached to the base. A single module may contain multiple independent devices, each having a different function. For instance, the extended communication module contains a GPIB device for parallel communications, a Centronics interface device for printing to a printer, and an analog output device for output of measurement data as an analog voltage. There are four basic classes or types of devices based on primary function:

### **Input device**

An input device is used by the base controller for measuring sensors and signals. An input device may have multiple input channels. The input class includes such devices as the SPRT and thermocouple modules.

### **Output device**

An output device is able to receive measurement data from the base controller and transmit the data to other instruments. A data output device may have multiple output channels. The output class includes such devices as the analog output.

### **Printer interface device**

A printer interface device is able to receive text data from the base controller and send it to an external printer, terminal, or data storage device. The printer interface class includes the Centronics printer interface and the printer output function of the built-in RS-232 interface.

### **Communication device**

A communication device provides bi-directional communications between an external instrument or computer and the 1560 system. This can be used to set parameters, read measurement data, and control the operation of the 1560. The communications class includes the IEEE-488 GPIB interface device and the bi-directional communication function of the built-in RS-232 serial interface device.

Each add-on module contains its own microprocessor that allows it to operate independently with little supervision from the base controller. It also contains its own circuitry required for its specific application. This may include circuitry for resistance or voltage sensing, digital conversion, temperature sensing, channel switching, and digital communications. All circuits are directly controlled by the module's microprocessor. The module microprocessor handles any critical timing, over sampling, and error compensation calculations required to make accurate measurements. Modules that require calibration to maintain accuracy store their own calibration coefficients in non-volatile random-access memory (NVRAM). Thus, the module remains calibrated even if it is moved from one 1560 system to another. The module calibration parameters can be accessed through the front panel of the base.

Each module recognizes and responds to a standard set of commands from the base via the module bus. Standard commands are used for module and device identification, status reporting, configuration, data input, and data output.

## **2.3 Data Processing**

This section explains how measurement data is sampled, processed, and output within the 1560 Black Stack system. Data flow is diagramed in Figure 5 with the details explained below.

### **2.3.1 Inputs**

Measurement data originates with input devices such as the SPRT module. Each input device provides one or more input channels. Each device is registered by the base controller on power up and the number of channels, measurement type, and applicable temperature conversion types are recorded. Input channels are assigned numbers in the order they are recognized (see Section 4.5.1). Data received from each input channel consists of a raw measurement value (in ohms or volts) as well as a cold-junction compensation (CJC) temperature for thermocouple inputs.

### **2.3.2 Sampling Control**

The sampling control block determines which input channels are read and when. The time is recorded with each measurement. The sampling interval (measurement delay) between measurements is user-programmable (see Section 5.1.1). As the sampling control block waits to receive data from an input channel, it displays the measurement status and channel number of the pending measurement on the status line of the display (see Section 2.2.1.1). After sampling, each measurement is immediately passed to the input average block.

### **2.3.3 Input Average**

The input average block calculates a moving average that includes the new measurement and a number of past measurements. Each input channel is averaged independently. The average count is user-programmable (see Section 5.1.5). After averaging, the measurement is immediately passed to the temperature conversion block. It is also stored internally (with the time stamp) for possible routing to display data fields or data output channels.

### **2.3.4 Temperature Conversion**

The temperature conversion block calculates temperature or some other derived quantity from the averaged measurement. The conversion may be performed using any one of a number of algorithms as appropriate for the type of input. These may include ITS-90, W (T90), IPTS-68, Callendar-Van Dusen, thermistor [T(R) or R (T)], polynomial, and thermocouple conversion of any standard type with internal or external cold-junction compensation. The conversion type and any associated coefficients that constitute a probe characterization are

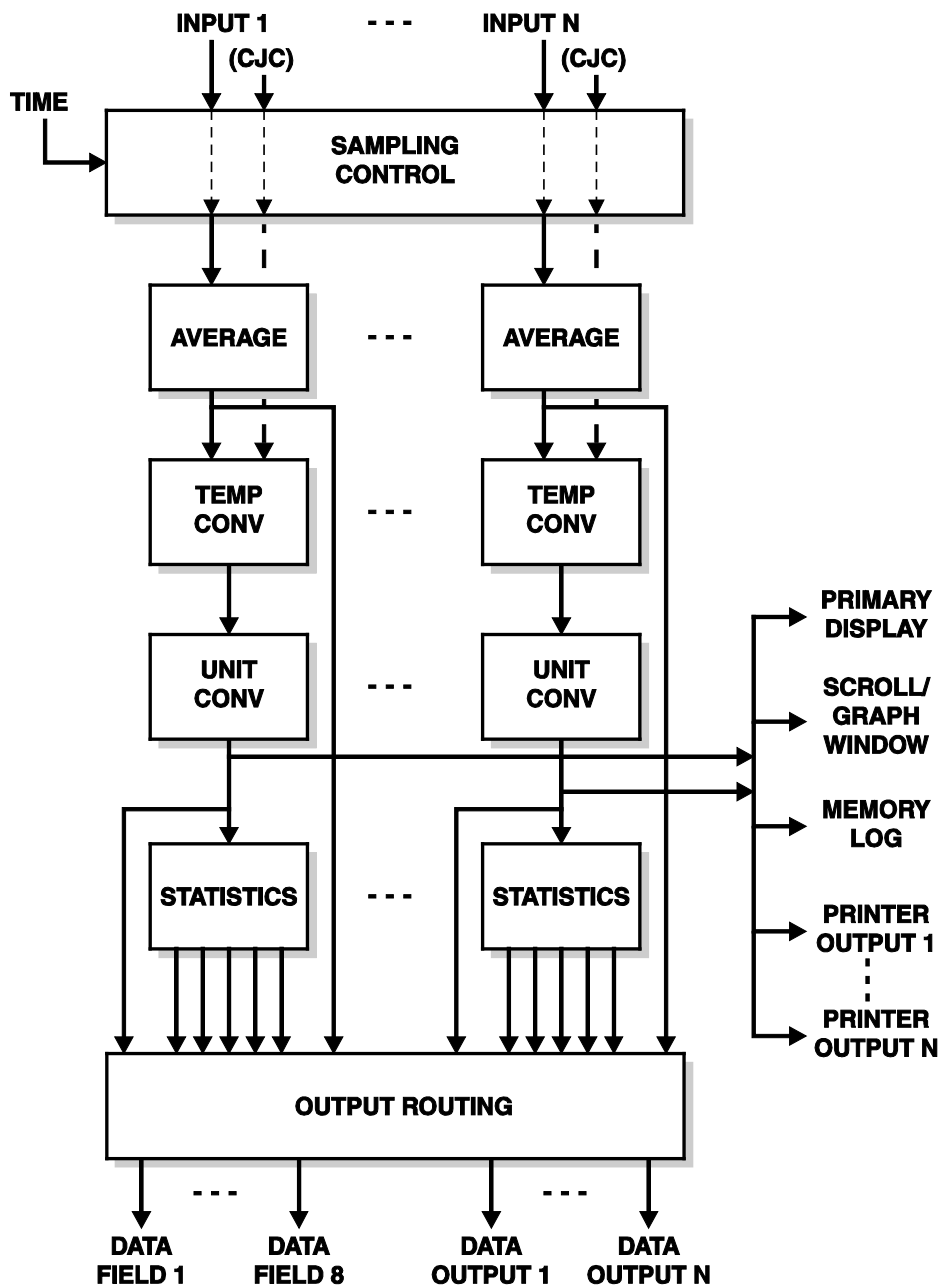

Figure 5. Data Flow

independently specified for each input channel (see Section 5.2.1). Some conversions, namely those for thermocouples, may use the CJC temperature read from the module with the measurement. Converted measurements are immediately passed to the unit conversion block.

### 2.3.5 Unit Conversion

The unit conversion block converts measurements to the appropriate units (see Section 5.5.1). The temperature conversion block produces temperature values in degrees Celsius (C). If the system units are degrees Fahrenheit (F) or Kelvin (K), the temperature value is converted accordingly.

### **2.3.6 Primary Measurement Display**

Each new measurement is immediately displayed on the front panel screen in the primary measurement window. The channel number appears on the right.

### **2.3.7 Graph and Scroll Windows**

Each new measurement also appears in the graph or scroll window, if visible.

### **2.3.8 Memory**

Each new measurement is stored in memory. Up to 1000 measurements can be stored. (The storage capacity may be reduced if a large number of input channels are added.) If the memory is full, the earliest measurement in memory is discarded when a new measurement is stored. The channel number, time, and units are stored with the measurement value. Measurements stored in memory can be printed (see Section 5.3.4).

### **2.3.9 Printer Outputs**

Each new measurement will be printed to any enabled printer device (see Section 5.3.3). The channel number, units, time, and date are also printed.

### **2.3.10 Statistics**

Each measurement is processed by the statistics block. The statistics block produces the following: the measurement value (no calculation), average, standard deviation, maximum, minimum, and spread. Each input channel is processed independently. The most recent statistical results for each input channel are stored internally for later transfer to outputs. The statistical registers can be reset by the user (see Section 5.3.5).

### **2.3.11 Output Routing**

The output routing block feeds measurements to the appropriate output channels. Any output channel can receive measurements from any input channel as well as the results of statistical calculations (see Section 5.3.2). When a new measurement is available, the output routing block passes it to all display fields and output channels programmed to receive it.

### **2.3.12 Display Data Fields**

In statistical mode, the center display window contains eight programmable data fields. These can display measurements from any input channel as well as the results of statistical calculations (see Section 5.3.1.1 and 5.3.1.2). Measurements are displayed with the channel number, units, time, and a label identifying the type of calculation.

### **2.3.13 Data Output Channels**

Output devices can receive measurements from any input channel as well as the results of statistical calculations (see Section 5.3.2). Each output device provides one or more output channels. Each device is registered by the base controller on power up and the number of channels are recorded. Output channels are assigned numbers in the order they are recognized.





# Chapter 3

## **Specifications and Environmental Conditions**

### **3.1 Specifications**

<b>Power</b>	100 to 230VAC ( ±10%), 50/60 Hz, .5A
<b>Weight (base only)</b>	4.5 lbs.
<b>Maximum number of modules</b>	8
<b>Maximum number of input channels</b>	96

\* Specifications for modules can be found in the chapters for the individual modules.

### **3.2 Environmental Conditions**

Although the instrument has been designed for optimum durability and trouble free operation, it must be handled with care. The instrument should not be operated in an excessively dusty or dirty environment. Maintenance and cleaning recommendations can be found in the Maintenance Section of this manual.

The instrument operates safely under the following conditions:

- temperature range: Absolute 5–35 °C (40–95 °F) Recommended 18 – 28 °C (64–82 °F)
- ambient relative humidity: 15–65 % (70 % below 30 °C)
- pressure: 75kPa–106kPa
- mains voltage within ±10 % of nominal
- vibrations in the calibration environment should be minimized
- altitude less than 2,000 meters



# Chapter 4

## General Operation

This section explains basic operation of the 1560 Black Stack. Operation of the 1560 is explained in greater detail in subsequent sections: Section 5 explains each of the functions available with the soft-keys and Section 6 explains the communication commands used to operate the 1560 remotely.

### 4.1 **Installing New Modules**

The 1560 is generally supplied with certain modules already attached. However, new modules can be purchased later and attached to the back of the existing system to add extra channels or new capabilities. Modules are individually calibrated at the factory before shipping and are ready to install and operate without configuring or programming coefficients. They need only be attached to the 1560.

*Note*

*Appropriate probe coefficients need to be entered.*

*Note*

*Before proceeding to install a new module you must recognize that adding new modules that contain input channels will alter the existing arrangement of input channels. All probe characterizations stored in memory will be invalidated. After installing the new module you will have to select the conversion algorithm and enter the characterization coefficients again for each input channel you want to use. Be prepared by having the coefficients on hand for each probe.*

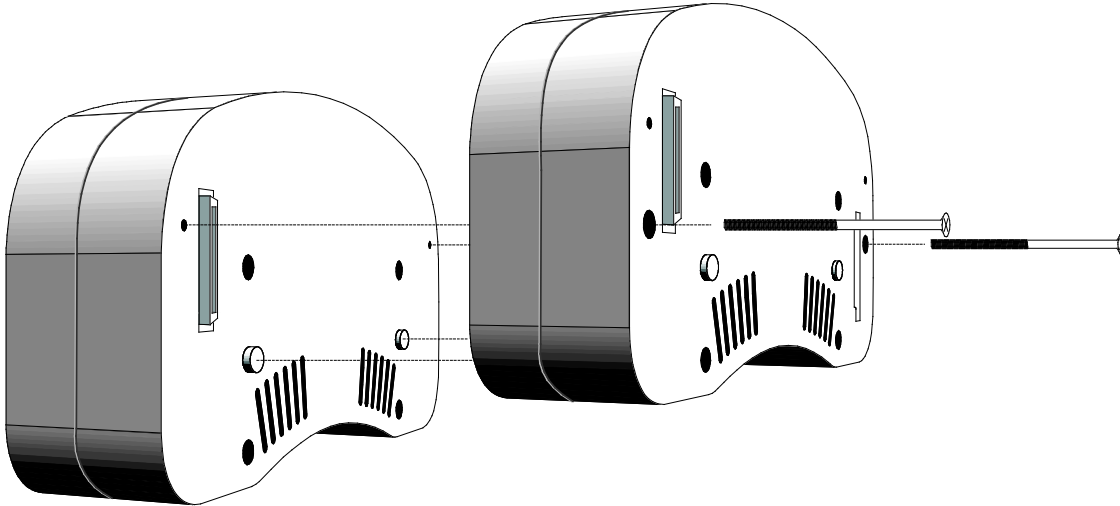

**Figure 6. Attaching New Modules**

The procedure for attaching a new module is as follows:

1. Turn off power to the 1560. Disconnect the power cord of the 1560 from the mains supply and disconnect the power cord from the back of the 1560.
2. Tilt the 1560 on its side to access the back of the last module. If screws are present in the two top holes, remove them. These holes will be needed to attach the new module to the back with screws. Remove the bus connector cover.
3. Place the new module onto the back of the last module. **Make sure the bus connectors mate properly and the alignment posts insert into the shallow holes.** The modules should be pressed together so they are tight against each other.
4. Insert two long (3½") screws into the two lower holes of the new module to fasten the new module to the one in front of it. Place the bus connector cover on the last module.

If properly attached, the new module will be automatically recognized by the 1560 when it is powered up. Observe the results of the self-test shown on the display just after the power is turned on to verify that the module is recognized and tested without any problems (see Section 4.3). The correct number of modules should be shown. If the module is not recognized or fails the self-test, turn the power off, disconnect the module and reattach it making sure the bus connections are solid.

The 1560 is now ready for operation with the extra channels and features the new module provides. If the new module has measurement capability, new channels will appear in the input channel list when selecting input channels (see Section 5.1.2 and 5.1.3). If the new module provides data output functions, new output channels will appear in the channel list when programming output channels (see Section 5.3.2). If the new module provides a printer interface, the new printer device will appear in printer device lists when selecting printing options (see Section 5.3.3 and 5.3.4). If the new module provides communication ports these can immediately be used to communicate with and control the 1560 remotely. Devices contained by the new module appear in the list for setting device parameters (Section 5.4.2) and the new module will appear in the module list in the system information window (Section 5.5.4).

*Note*

*Before making any measurements after installing a new module, be sure to properly select the temperature conversion type and enter probe characterization coefficients for each input channel you are using. Failure to do so may result in inaccurate temperature measurements!*

## **4.2 AC Power Source**

The 1560 requires an AC power source. See Section 3.1, Specifications, for details. The power supply automatically adjusts to the mains voltage. The 1560 may draw up to 0.5A.

The AC power cord attaches to the 1560 at the power socket located at the rear of the second section of the base. The power switch is also located at the rear of the second section.

## **4.3 Power On Self-Test**

When power is turned on, the 1560 will perform a self-test checking all the components in the system including the module bus and each module. It will report the status of each component on the screen. If an error occurs with the bus or modules it may be the result of an improper connection. Turn the power off, check the connections between the modules, and remove and reattach modules if necessary. If modules have been removed or rearranged, a warning message may appear noting that the module configuration has changed and that all probe parameters should be checked.



## **4.4 Adjusting the Screen Contrast**

When the 1560 is first powered on, the screen may appear faded, dark or blank if the contrast is not properly adjusted. Use the ◀▶ buttons located at the bottom of the left side of the front panel to adjust the contrast. As the 1560 warms up, the contrast may need to be adjusted.

## 4.5 Making Measurements

The procedure for configuring the 1560 to make measurements on a particular input channel involves a few simple steps: select the input channel, set the conversion type and probe characterization coefficients, and enable measuring. These steps are explained below.

### 4.5.1 Selecting Input Channels

Input channels are selected by number using the **PRIM CHAN** soft-key in the **INPUT** menu (see Section 5.1.2). The channel is selected from a window showing a list of all available input channels. Each channel in the list is identified with the device name, the channel number, and probe serial number. The channel is selected by using the   buttons to move the cursor to the desired channel and pressing **ENTER**.

```
SELECT THE PRIMARY CHANNEL
-----
>SPRT 01, PROBE 566-011
  SPRT 02, PROBE 566-012
  TCS  03, PROBE 1341
  TCS  04, PROBE 1342
  TCS  05, PROBE 1343
  TCS  06, PROBE 1344      ↓
```

*Note*

*Channel numbers are assigned to input channels according to their physical locations. They are not marked on modules since the locations may change depending on how modules are attached. Channel numbers are assigned in sequence, starting with 1, from left to right, front to back. The left-most channel on the first module is channel 1, the next channel on the right is channel 2, etc. The sequence continues with the next module in the same fashion (see Figure 7). Output channel numbers are assigned using the same scheme.*

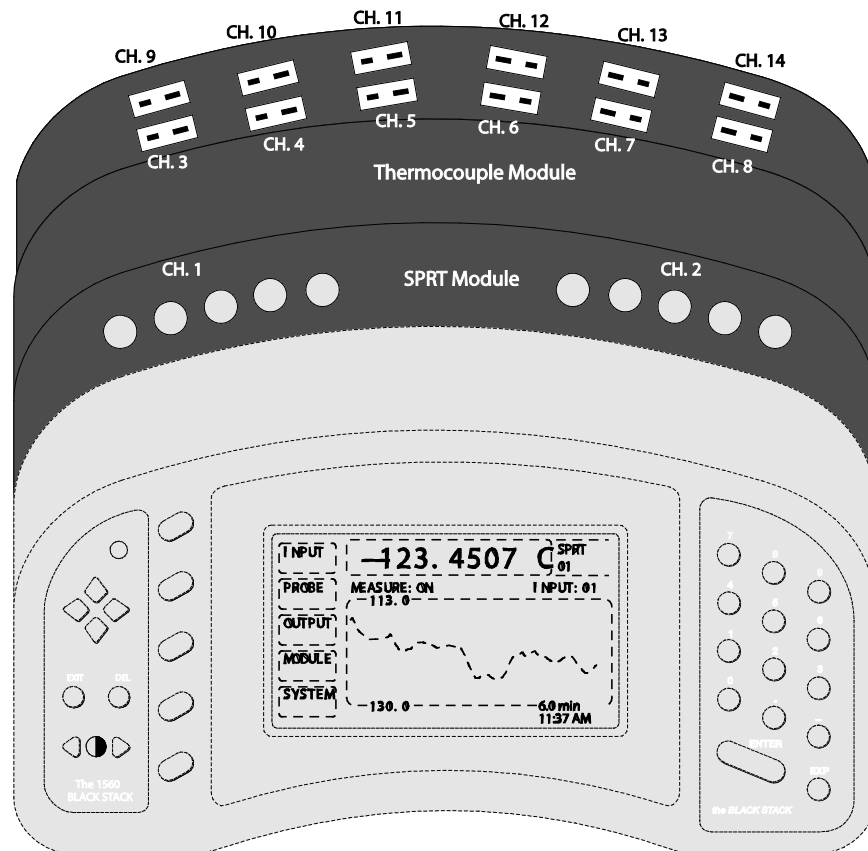





Figure 7. Channel Numbering

#### 4.5.2 Selecting the Probe Characterization

Before the 1560 can accurately measure temperature, it must know how to calculate temperature from the resistance or voltage of the sensor. There are many temperature conversion algorithms available and the one to use depends on the type of sensor and its calibration. Many conversion algorithms use coefficients that characterize the sensor. Coefficients are determined when the sensor is calibrated. SPRTs and RTDs often use the ITS-90 algorithms and are provided with ITS-90 characterization coefficients. Thermistors often use the Steinhart-Hart algorithms and coefficients. Thermocouples use standard tables or equations depending on its type.

The conversion type and characterization coefficients for a sensor are specified using the **EDIT PROBE** soft-key in the **PROBE** menu (see Section 5.2.1). First you must select the channel to which the sensor is connected. A window appears showing a list of all available channels. Each channel in the list is identified with the device name, the channel number, and the serial number. The channel is selected using the   buttons and pressing **ENTER**.

```
SELECT A CHANNEL TO EDIT
-----
>SPRT 01, PROBE 566-011
  SPRT 02, PROBE 566-012
  TCS   03, PROBE 1341
  TCS   04, PROBE 1342
  TCS   05, PROBE 1343
  TCS   06, PROBE 1344      ↓
```

Next, you select the conversion type and enter characterization coefficients, if necessary. You can move to any parameter in the window with the   buttons. After changing the value for any parameter you must press **ENTER** for the new value to be accepted.

```
EDIT SPRT 01
-----
PROBE SER#: 566-011
CONVERSION: ITS-90
LO RANGE: 4
HI RANGE: 7
R[273]: 25.546738
A[4]: -1.5763669E-4      ↓
```

Press **EXIT** twice to return to the soft-key menu. The coefficients you entered can be verified by using the **TEST CONV** soft-key function (see Section 5.2.3) to compare calculated temperatures to expected values from a calibration report.



### 4.5.3 *Measuring One Channel*

The 1560 can be set up to measure one channel continuously. To do this the scan mode must be set to primary channel and the measure mode must be on. The scan mode is set using the **SCAN MODE** soft-key function in the **INPUT** menu (see Section 5.1.4). Use the **◀ ▶** buttons to set SCAN MODE to PRIM CHAN and press **ENTER**. Press **EXIT** to return to the menu. The measure mode is set using the **MEAS** soft-key function in the **INPUT** menu (see Section 5.1.1). Use the **◀ ▶** buttons to set MEASURE to ON and press **ENTER**. Press **EXIT** to return to the menu. See Section 4.5.1, Selecting Input Channels, for information on how to set the primary channel.

### 4.5.4 *Scanning Channels*

The 1560 can be set up to measure several channels in sequence. To do this the scan mode must be set to scan and the measure mode must be on. The scan mode is set using the **SCAN MODE** soft-key function in the **INPUT** menu (see Section 5.1.4). Use the buttons to set SCAN MODE to SCAN CHAN and press **ENTER**. Press **EXIT** to return to the menu. The measure mode is set using the **MEAS** soft-key function in the **INPUT** menu (see Section 5.1.1). Use the buttons to set MEASURE to ON and press **ENTER**. Press **EXIT** to return to the menu. The 1560 will scan only channels that are enabled. Channels can be enabled or disabled using the **SCAN CHAN** soft-key function in the **INPUT** menu (see Section 5.1.3).

### 4.5.5 *Displaying Measurement Data*

Each measurement appears in the primary measurement window at the top of the screen and is labeled with the input channel number. The area in the center of the screen below the primary measurement window can be used to show measurement data in a variety of formats. To graph measurements, select the **OUTPUT** menu, the **DISP WINDOW** sub-menu, and the **GRAPH WINDOW** function (see Section 5.3.3). To show multiple lines of selected data, select the **STAT WINDOW** function in the **DISP WINDOW** sub-menu (see Section 5.3.1). The type of data is selected using the **SET FIELDS** function (Section 5.3.2). To show a list of most recent measurements, select the **SCROLL WINDOW** function in the **DISP WINDOW** sub-menu (Section 5.3.5).



# Chapter 5

## Soft-Key Functions

The soft-key menu system provides a convenient method of accessing a large number of functions from the front panel with only a few buttons. The soft-keys next to the display are used to select particular functions. Labels on the display next to the soft-key identify the functions. Since there are many more functions than soft-keys, a nested menu structure is used. Related functions appear together in a soft-key menu. The soft-key menu system is outlined in Table 2. Each soft-key function is described in detail in the following sections, organized by menu. The **EXIT** key is used to return from a lower menu to the main menu.

### 5.1 Input Menu

The **INPUT** menu provides functions for controlling the measurement process, selecting input channels, and setting measurement averaging. The soft-key functions that appear in this menu are **MEAS**, **PRIM CHAN**, **SCAN CHAN**, **SCAN MODE**, and **AVER**.

#### 5.1.1 Measure

The **MEAS** soft-key allows you to control the measurement action. A window shows the current settings of the measurement parameters and allows them to be changed.

SET MEASUREMENT PARAMETERS	
MEASURE: ON	◀▶
COUNT N: 1	
DELAY: 0	
SEQ TIMER: 0	

The **MEASURE** parameter enables or disables measuring. Options are selected using the **◀▶** buttons and pressing **ENTER**. The possible options are OFF, ON, and COUNT. If ON is selected the instrument measures continuously. If COUNT is selected the instrument immediately begins measuring the number of measurements given by the COUNT N number. The current measurement status is always indicated on the status message line below the primary measurement window (see Section 2.2.1.1).

The COUNT N parameter (1 to 32,767) specifies the number of measurements to acquire before stopping when the MEASURE mode is set to COUNT. Use the numeric buttons to enter a value and press **ENTER**.



**Table 2. Soft-key Menu System**

<b>INPUT</b>	
<b>MEAS</b>	Set Measurement control parameters
<b>PRIM CHAN</b>	Select the primary input channel
<b>SCAN CHAN</b>	Select input channels for scanning
<b>SCAN MODE</b>	Select the scan mode
<b>AVER</b>	Set input averaging
<b>PROBE</b>	
<b>EDIT PROBE</b>	Edit the probe parameters for a channel
<b>COPY PROBE</b>	Copy probe parameters from one channel to another
<b>TEST CONV</b>	Test the temperature conversion for a probe
<b>OUTPUT</b>	
<b>DISP WINDOW</b>	Set up the display window
<b>STAT WINDOW</b>	View the statistical window
<b>SET FIELDS</b>	Select data for the statistical window
<b>GRAPH WINDOW</b>	View the graph window
<b>CLEAR GRAPH</b>	Clear the graph window
<b>SCROLL WINDOW</b>	View the scroll window
<b>OUTPUT CHAN</b>	Select data for output channels
<b>PRINT OUTPUT</b>	Control the output to printer devices
<b>PRINT MEMORY</b>	Print data stored in memory
<b>CLEAR STATS</b>	Clear the statistical functions
<b>MODULE</b>	
<b>SET UP SCREEN</b>	Set front panel screen parameters
<b>SET UP DEVICE</b>	Set device parameters
<b>CAL DEVICE</b>	Calibrate device
<b>MODULE INFO</b>	View module information
<b>SYSTEM</b>	
<b>UNITS</b>	Select temperature units
<b>TIME</b>	Set the time and date
<b>PASSWORD</b>	Set the password lock-out options
<b>SYSTEM INFO</b>	View system information
<b>SYSTEM RESET</b>	Reset system parameters

The DELAY parameter (0 to 32,767) sets the minimum delay time, in seconds, between each measurement. Use the numeric buttons to enter a value and press **ENTER**. Measurements may take longer than the specified delay time, if necessary. This value also affects the time axis of the graph window.

The SEQ TIMER parameter (0 to 10,000) times the start of each scan sequence. For instance, if SEQ TIMER is set to 300, the scan sequence will run once every five minutes. If the SEQ timer value is 0, scanning will run continuously. This applies only with the SCAN CHAN and SCAN/PRIM scan modes. The SEQ TIMER value is ignored when the time scale of the graph display is calculated. Consider disabling the average function (Section 5.1.5) when using long measurement intervals.



### 5.1.2 Primary Channel

The **PRIM CHAN** soft-key selects the primary input channel. The channel is selected from a window showing a list of all available input channels. Each channel in the list is identified with the device name, the channel number, and probe serial number. The channel is selected using the   buttons and pressing **ENTER**.

```
SELECT THE PRIMARY CHANNEL
-----
>SPRT 01, PROBE 566-011
  SPRT 02, PROBE 566-012
  TCS  03, PROBE 1341
  TCS  04, PROBE 1342
  TCS  05, PROBE 1343
  TCS  06, PROBE 1344
```

Selecting a primary channel will also set the SCAN MODE to PRIM CHAN (see Section 5.1.4).

### 5.1.3 Scan Channels

The SCAN CHAN soft-key allows you to select channels to scan with the SCAN and SCAN/PRIM measurement modes. A window shows a list of all channels and the ON/OFF state of each. Only channels that are set to ON will be measured when the SCAN MODE is SCAN or SCAN/PRIM. Each channel in the list is identified with the device name and the channel number. You can scroll through the list using the  buttons. The indicated channel can be toggled on or off using the  buttons. It is not necessary to press **ENTER**. Press **EXIT** to exit.

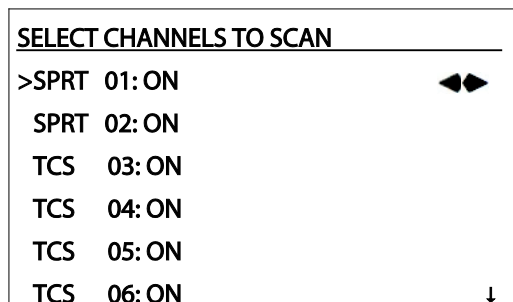

Selecting channels to scan will also set the SCAN MODE to SCAN CHAN.

### 5.1.4 Scan Mode

The **SCAN MODE** soft-key is used to set the input channel scan mode. The available options for SCAN MODE are as follows:

**PRIM CHAN**: measure the primary channel only. The channel is selected with the **PRIM CHAN** soft-key as explained in Section 5.1.2 above.

**SCAN CHAN**: measure selected scan channels in sequence. The channels are selected with the **SCAN CHAN** soft-key as explained in Section 5.1.3 above.

**SCAN/PRIM**: measure selected scan channels while alternating with the primary channel. The scan channels are selected with the **SCAN CHAN** soft-key as explained in Section 5.1.3 above. The primary channel is selected with the **PRIM CHAN** soft-key as explained in Section 5.1.2 above.

Select the primary channel and enable scan channels prior to setting the scan mode to this option.

The scan mode is selected using the  buttons and pressing **ENTER**.

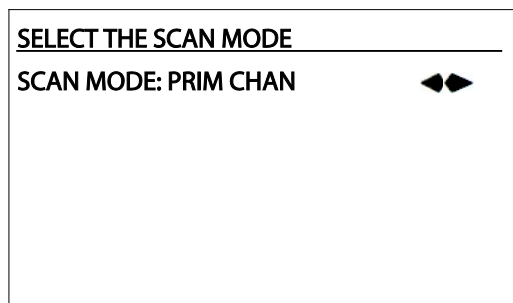

### 5.1.5 Average

The **AVER** soft-key is used to set input averaging. This moving average filter is useful for smoothing variations in the measurements and improving resolution.

The AVERAGE parameter determines whether averaging is disabled (OFF) or enabled (ON). Use the **◀▶** buttons to select ON or OFF for AVERAGE and press **ENTER**.

The COUNT parameter determines the number of raw measurements that are averaged to produce the displayed measurement. The range is from 1 to 10. Use the numeric buttons to enter a value for COUNT and press **ENTER**.

```
SET THE INPUT AVERAGING
-----
AVERAGE: OFF
COUNT:  1
```

## 5.2 Probe Menu

The **PROBE** menu provides functions for selecting the type of temperature conversion and setting the characterization coefficients for input channels. The soft-key functions that appear in this menu are **EDIT PROBE**, **COPY PROBE**, and **TEST CONV**. If the PROBE password option is set ON, you must enter the correct password in order to access these functions (see Section 5.5.3). Use the numeric keys and **ENTER** to enter the four-digit password. If the correct password is entered the **PROBE** menu appears.

```
PASSWORD REQUIRED FOR ACCESS.
PASSWORD:  0
```

### 5.2.1 Edit Probe

The EDIT PROBE soft-key allows you to enter probe characterization coefficients and other probe parameters for temperature calculation. First, you must select the input channel. A window appears showing a list of input channels. Each channel in the list is identified with the device name, the channel number, and the probe serial number. The channel is selected using the **◀▶** buttons and pressing **ENTER**.

```
SELECT A CHANNEL TO EDIT
-----
>SPRT 01, PROBE 566-011
  SPRT 02, PROBE 566-012
  TCS  03, PROBE 1341
  TCS  04, PROBE 1342
  TCS  05, PROBE 1343
  TCS  06, PROBE 1344      ↓
```

After the channel is selected, a new window appears allowing you to edit the probe parameters for the selected channel. The probe parameters include the probe serial number, conversion type, and characterization coefficients and parameters. The available coefficients may change depending on the conversion type that is selected.

```
EDIT SPRT 01
-----
PROBE SER#: 566-011
CONVERSION: ITS-90
LO RANGE: 4
HI RANGE: 7
RTPW: 25.546738
A[4]: -1.5763669E-4      ↓
```



The PROBE SER# parameter is the serial number for the probe. The serial number consists of a string of up to eight characters using any numeric digits, letters, minus signs, and decimal points. Use the appropriate numeric buttons to enter digits. Letters are entered by pressing the **EXP** button. Press this button repeatedly until the desired letter appears.

The CONVERSION parameter specifies the conversion type. The entire list of possible conversion types is given in Table 3. The conversion types available for a given channel depend on the type of input as indicated in the table. The conversions and related coefficients and parameters are explained in the following sub-sections.



**Table 3. Conversion Types**

Sensor Type	Conversion options
SPRT, PRT, and RTD	R( $\Omega$ )
	ITS-90 (default)
	W(T90)
	IPTS-68
	CVD
	POLYNOMIAL
Thermistor	R( $\Omega$ )
	THRM T(R)
	THRM R(T) (default)
	POLYNOMIAL
2564 module also has	ITS-90
	W(T90)
	IPTS-68
	CVD
Thermocouple	V
	TC-B
	TC-E
	TC-J
	TC-K (default)
	TC-N
	TC-R
	TC-S
	TC-T
	TC-AU/PT
	TC-TABLE
	TC-POLY
Others	NONE (default)
	POLYNOMIAL

You can move to any parameter in the window with the   buttons. After entering a value for a parameter, **ENTER** must be pressed. The window can be exited by pressing **EXIT**. After the parameter editing window is exited, the SELECT A CHANNEL TO EDIT screen reappears. You can select another channel to edit or press **EXIT** to return to the soft-key menu.

### 5.2.1.1 $R(\Omega)$ Conversion

```
EDIT SPRT 01
-----
PROBE SER#: 1
CONVERSION: R( $\Omega$ )
```

The  $R(\Omega)$  conversion displays the measurement as resistance in ohms rather than temperature.

### 5.2.1.2 ITS-90 Conversion

```
EDIT SPRT 01
-----
PROBE SER#: 1
CONVERSION: ITS-90
LO RG: 4, 83k - 273k
HI RG: 7, 273k - 933k
RTPW: 25.546738
A[4]: -1.5763669E-4 ↓
```

The ITS-90 conversion converts resistance to temperature according to the ITS-90 specifications for SPRTs. Most PRTs and SPRTs are characterized according to the International Temperature Scale of 1990 (ITS-90). For details about the ITS-90 see NIST Technical Note 1265, *Guidelines for Realizing the International Temperature Scale of 1990*. The user-defined parameters for the ITS-90 conversion include two sub ranges (LO RG and HI RG), the triple point of water resistance (RTPW), and various coefficients of the ITS-90 deviation functions that are applicable for the selected sub ranges. If you select ITS-90 for CONVERSION, you must then select one or two sub-ranges then enter the coefficients for the sub-ranges. You may select both a low temperature sub-range and a high temperature sub-range. At temperatures where the high and low ranges overlap, the low range takes precedence. If the probe is calibrated for only one range, set the unused high or low range to NONE. If both sub-ranges are set to NONE the temperature will be calculated using the ITS-90 reference function. When using range 6 (273.15 to 1234.93K), note that you do not need to enter the value for W (933.473K). This value is calculated automatically based on the coefficients  $a_6$ ,  $b_6$ , and  $c_6$ .

### 5.2.1.3 $W(T_{90})$ Conversion

```
EDIT SPRT 01
PROBE SER#: 1
CONVERSION: W(T90)
RTPW: 25.412294
```

The  $W(T_{90})$  conversion displays the measurement in ITS-90  $W(T_{90})$  values rather than temperature. The one user-defined parameter for the  $W(T_{90})$  conversion is the triple point of water resistance, RTPW.

### 5.2.1.4 IPTS-68 Conversion

```
EDIT SPRT 01
PROBE SER#: 1
CONVERSION: IPTS-68
SCALE: IPTS-68
R0: 100.00845
ALPHA: 0.00391648
DELTA: 1.4872 ↓
```

The IPTS-68 conversion calculates temperature according to the IPTS-68 specifications. Only sub range 4 is implemented for temperatures below zero. The user-defined parameters for the IPTS-68 conversion are R0 ( $R_0$ ), ALPHA  $\alpha$ , DELTA ( $\delta$ ), A[4] ( $A_4$ ), C[4], ( $C_4$ ), and SCALE. The SCALE parameter determines whether the temperature values conform to IPTS-68 or ITS-90.

### 5.2.1.5 Calendar-Van Dusen Conversion

The following equations are used for the Calendar-Van Dusen conversion:

```
EDIT SPRT 01
PROBE SER#: 1
CONVERSION: CVD
R0: 100.0
ALPHA: 0.00385
DELTA: 1.507
BETA: 0.111
```

$$r(t[{}^{\circ}C]) = \begin{cases} R_0 \left\{ 1 + \alpha \left[ t - \delta \frac{t}{100} \left( \frac{t}{100} - 1 \right) \right] \right\} & t \geq 0 \\ R_0 \left\{ 1 + \alpha \left[ t - \delta \frac{t}{100} \left( \frac{t}{100} - 1 \right) - \beta \left( \frac{t}{100} - 1 \right) \left( \frac{t}{100} \right)^3 \right] \right\} & t \leq 0 \end{cases}$$

The user-defined parameters for the Calendar-Van Dusen conversion are R0 (R<sub>0</sub>), ALPHA (α), DELTA (δ), and BETA (β). The defaults are R0: 100.0, ALPHA: 0.00385055, DELTA: 1.4998, and BETA: 0.109 which are applicable with DIN-43760 or IEC-751 type RTDs.

Some probes may be provided with A, B, and C coefficients for the Calendar-Van-Dusen equation in the following form:

$$r(t[{}^{\circ}C]) = \begin{cases} R_0(1 + At + B^2) & t \geq 0 \\ R_0[1 + At + Bt^2 + C(t-100)t^3] & t \leq 0 \end{cases}$$

The A, B, and C coefficients can be converted to α, δ, and β coefficients using the following formulas:

$$\alpha = A + 100B \quad \delta = -\frac{100}{\frac{A}{100B} + 1} \quad \beta = -\frac{10^8 C}{A + 100B}$$

### 5.2.1.6 RTD Polynomial Conversion

```

EDIT SPRT 01
PROBE SER#: 1
CONVERSION: POLYNOMIAL
A[0]: -35.540960
A[1]: 0.36568108
A[2]: -1.884784E-4
A[3]: 7.26691E-6
    
```

The following equation is used for the RTD polynomial conversion:

$$t(r)[{}^{\circ}C] = \sum_{i=0}^{10} a_i r^i$$

The user-defined parameters for the polynomial conversion are A[0] (a<sub>0</sub>) through A[10] (a<sub>10</sub>). Any unused coefficients should be set to 0.

### 5.2.1.7 Thermistor T(R) Conversion

```

EDIT STHR 01
PROBE SER#: 1
CONVERSION: THRM-T(R)
A[0]: -35.540960
A[1]: 0.36568108
A[2]: -1.884784E-4
A[3]: 7.26691E-6

```

The following Steinhart-Hart equation is used for the thermistor T(R) conversion:

$$T(r)[K] = [A_0 + A_1 \ln r + A_2 \ln^2 r + A_3 \ln^3 r]^{-1}$$

The user-defined parameters for the thermistor T(R) conversion are A[0] ( $A_0$ ) through A[3] ( $A_3$ ). If  $A_2$  is not used, as is the case with some calibrations, A[2] should be set to 0.0.

### 5.2.1.8 Thermistor R(T) Conversion

```

EDIT STHR 01
PROBE SER#: 1
CONVERSION: THRM-T(R)
A[0]: -35.540960
A[1]: 0.36568108
A[2]: -1.884784E-4
A[3]: 7.26691E-6

```

The following Steinhart-Hart equation is used for the thermistor R(T) conversion:

$$r(T[K]) = \exp[B_0 + B_1 T^{-1} + B_2 T^{-2} + B_3 T^{-3}]$$

The user-defined parameters for the thermistor R(T) conversion are B[0] ( $B_0$ ) through B[3] ( $B_3$ ). If  $B_2$  is not used, as is the case with some calibrations, B[2] should be set to 0.0.

### 5.2.1.9 Thermocouple Volts Conversion

```

CHANNEL: TCS 3
PROBE SER#: 1
CONVERSION: V

```

The volts conversion for thermocouples displays the measurement in volts rather than temperature.

The voltage readings are not compensated with the CJC value.

*Note*

*When selecting volts as the conversion type for thermocouples, no cold-junction compensation is available. The value measured and displayed is the uncompensated voltage as sensed at the input of the module.*

**5.2.1.10 Standard Thermocouple Conversions**

```
EDIT TCS 03
PROBE SER#: 1
CONVERSION: TC-K
CJC: INTERNAL
CJC TEMP: 0.0
CAL PTS: 3
T1: 500.0 ↓
```

*Note*

*An Application Note for use of Tungsten-Rhenium and other thermocouples is available at [www.hartscientific.com](http://www.hartscientific.com).*

Standard thermocouple conversions include types B, E, J, K, N, R, S, T, and gold-platinum (AU/PT). Voltage is converted to temperature using standard reference functions. (For additional information consult the publication NIST Monograph 175.)

The gold-platinum thermocouple conversion uses a ninth-order polynomial with the following coefficients:

- $c_0 = 0.0$
- $c_1 = 6.03619861$
- $c_2 = 1.93672974 \times 10^{-2}$
- $c_3 = -2.22998614 \times 10^{-5}$
- $c_4 = 3.28711859 \times 10^{-8}$
- $c_5 = -4.24206193 \times 10^{-11}$
- $c_6 = 4.56927038 \times 10^{-14}$
- $c_7 = -3.39430259 \times 10^{-17}$
- $c_8 = 1.42981590 \times 10^{-20}$
- $c_9 = -2.51672787 \times 10^{-24}$

You can specify internal or external cold-junction compensation (CJC) with the CJC parameter. If CJC is specified as internal, the CJC TEMP value is read from the thermocouple input and is updated automatically; there is no need to set this value. With external CJC, a reference junction at a known fixed temperature is used and the value of this fixed temperature reference is used to calculate the absolute temperature of the thermocouple. The CJC TEMP parameter must be set, in degrees C, to the temperature of the external reference. If CJC is specified as internal, the CJC TEMP parameter is ignored.

Conversions for each of the thermocouple types accept optional calibration data. This can be used to improve the measurement accuracy. CAL PTS indicates the number of calibration points used, up to three. T<sub>n</sub> is the temperature of the point. ADJ<sub>n</sub> is the temperature deviation from the reference function at the point. The temperature measurement will be adjusted by this amount when measuring at this temperature. A polynomial interpolation function is used for measurements between calibration points. If calibration data is not available or is not to be used, the ADJ<sub>n</sub> parameters should all be set to 0.0. This will cause the temperature to be calculated according to the standard reference functions.

Some thermocouple conversions (types R, S, and gold-platinum) also accept polynomial calibration coefficients. This produces a temperature-dependent adjustment to the voltage according to the polynomial function:

$$\Delta E(t_s [^{\circ}C]) [\mu V] = \Delta c_1 t_s + \Delta c_2 t_s^2$$

The probe parameters DC1 and DC2 are used to set the values of  $\Delta c_1$  and  $\Delta c_2$  respectively. If no calibration coefficients are available or if only the standard reference function is to be used, DC1 and DC2 should be set to 0.0. If these coefficients are used, the ADJ<sub>n</sub> parameters described above must be set to 0.

### 5.2.1.11 Thermocouple Table Conversion

```

EDIT TCS 03
-----
PROBE SER#: 1
CONVERSION: TC-TABLE
CJC: INTERNAL
CJC TEMP: 0.0
TABLE PTS: 10
T1(C): -200.0
    
```

The thermocouple table conversion allows calculation of temperature by interpolating from a table. You can enter the temperatures (in °C) and voltages (in V) from a reference or calibration table for one to ten points. The number of points is specified by TABLE PTS. To calculate temperature, a polynomial interpolation is done using up to four of the points in the table closest to the given temperature or voltage. The zero point (0 V at 0 °C) is automatically included in the table whether it is explicitly specified or not.

### 5.2.1.12 Thermocouple Polynomial Conversion

EDIT TCS 03
PROBE SER#: 1
CONVERSION: TC-POLY
CJC: INTERNAL
C0: 0.0
CJC TEMP: 0.0
C1: 0.038562

*Note*

*An Application Note for use of Tungsten-Rhenium and other thermocouples is available at [www.hartscientific.com](http://www.hartscientific.com).*

The following equation is used for the thermocouple polynomial conversion:

$$E(t[{}^{\circ}C])[\mu V] = \sum_{i=1}^{15} c_i t^i$$



*Note*

*The EMF (E) in the above equation is in microvolts. If the calibration equation for the coefficients of the probe being used is in milli-volts, each coefficient needs to be multiplied by 1000 before entering the coefficients into the instrument.*



The user-defined parameters for the thermocouple polynomial conversion are the coefficients C0 (C<sub>0</sub>) through C15 (C<sub>15</sub>). The user can specify internal or external cold-junction compensation (CJC). If external CJC is selected, the user can enter the temperature of the CJC reference. DC1 and DC2 are only accessible when type R is used.



### 5.2.2 Copy Probe

The **COPY PROBE** soft-key can be used to copy an entire set of probe parameters from one input channel to another. The parameters are copied in two steps—select the source channel then select the destination channel. A window appears requesting you to select the source channel. Each channel in the list is identified with the device name, the channel number, and the probe serial number. The list includes two **USER** channels that can be used for temporary storage. The source channel is selected using the   buttons and pressing **Enter**.

```
SELECT THE CHANNEL TO COPY FROM
>SPRT 01, PROBE 566-011
  SPRT 02, PROBE 566-012
  TCS 03, PROBE 1341
  TCS 04, PROBE 1342
  TCS 05, PROBE 1343
  TCS 06, PROBE 1344 ↓
```

After the source channel is selected, a window appears requesting you to select the destination channel. The destination channel is selected using the   buttons and pressing **ENTER**.



```
SELECT THE CHANNEL TO COPY TO
>SPRT 01, PROBE 566-011
  SPRT 02, PROBE 566-012
  TCS 03, PROBE 1341
  TCS 04, PROBE 1342
  TCS 05, PROBE 1343
  TCS 06, PROBE 1344 ↓
```

After the destination channel is selected, a window appears requesting you to confirm the action. Press **ENTER** to proceed with copying the parameters or press **EXIT** to cancel the operation. If **ENTER** is pressed, the probe parameters will be copied from the source channel to the destination channel.

```
PARAMETERS FOR SPRT 01 WILL BE
OVERWRITTEN.
PRESS ENTER TO PROCEED OR
PRESS EXIT TO CANCEL.
```

If the source channel type and the destination channel type are incompatible (e.g., PRT channel and TC channel), a message appears indicating that the input types are incompatible and the copy function fails. User channels can be used to temporarily store any type of channel.

### 5.2.3 Test Conversion

The **TEST CONV** soft-key allows you to test the probe characterization algorithm and characterization coefficients for a specific probe. You must first select the channel number of the probe. A window appears requesting you to select the input channel. Each channel in the list is identified with the device name, the channel number, and the probe serial number. The channel is selected using the   buttons and pressing **ENTER**.

```
SELECT A PROBE TO TEST
-----
>SPRT 01, PROBE 566-011
  SPRT 02, PROBE 566-012
  TCS  03, PROBE 1341
  TCS  04, PROBE 1342
  TCS  05, PROBE 1343
  TCS  06, PROBE 1344      ↓
```

After the probe is selected, a new window appears allowing you to test the temperature calculation for the probe. You can enter an input value (e.g. resistance) and the corresponding output value (e.g. temperature) will be shown. Press **EXIT** to exit.

```
TEST CONVERSION
-----
RESISTANCE: 100.0145
TEMP (C): 0.0101
```

## 5.3 Output Menu

The **OUTPUT** menu provides functions for controlling the display and output of data. The soft-key functions that appear in this menu are **DISP WINDOW**, **OUTPUT CHAN**, **PRINT OUTPUT**, **PRINT MEMORY**, and **CLEAR STATS**.

### 5.3.1 Display Window Menu

The **DISP WINDOW** sub-menu provides functions for controlling the display of data on the front panel screen. The soft-key functions that appear in this sub-menu are **STAT WINDOW**, **SET FIELDS**, **GRAPH WINDOW**, **CLEAR GRAPH**, and **SCROLL WINDOW**.

#### 5.3.1.1 Statistical Window

The **STAT WINDOW** soft-key selects the statistical window for viewing. The statistical window consists of eight programmable lines of data as shown below. The data for each line is set up with the **SET FIELDS** function described next.

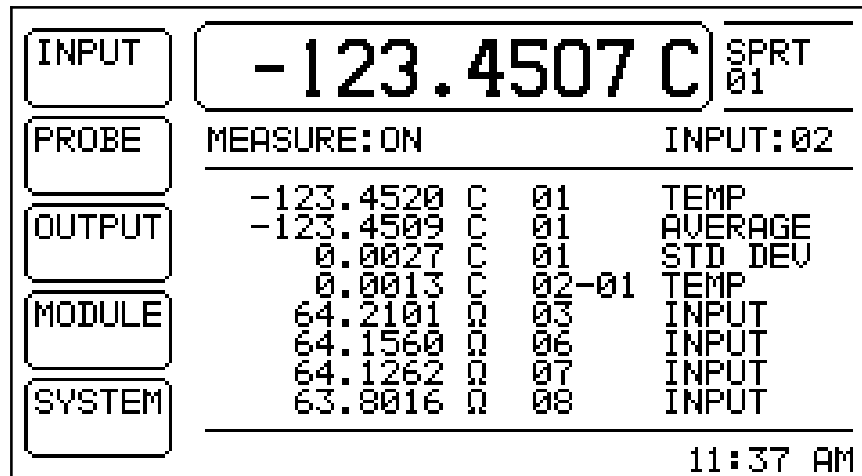

Figure 8. Typical Statistical Display

#### 5.3.1.2 Set Fields

The **SET FIELDS** soft-key allows you to select the data displayed on each of the eight data fields of the statistical window. You are requested to select the field to edit. The choices are 1 through 8. Use the numeric buttons to enter a number and press **ENTER**.

SELECT A DISPLAY FIELD \_\_\_\_\_

DISPLAY FIELD: 1

Next, a new window appears allowing you to select the data for the given field.



**SELECT THE DATA FOR FIELD 1**

---

+CHANNEL: 1  
 -CHANNEL: 0  
 CALCULATION: TEMP

CHANNEL 0=NONE  
 CHANNEL 99=ALL

+ CHANNEL specifies the input channel for the positive component of the difference calculation. -CHANNEL specifies the input channel for the negative component of the difference calculation. You may enter 0 to ignore that part of the calculation or 99 to apply the most recent measurement regardless of channel. Use the numeric buttons to enter a number and press **ENTER**.

**CALCULATION** specifies the type of calculation for which the results are displayed. The options are given in Table 4 below. The calculation is selected using the   buttons and pressing **ENTER**.

**Table 4. CALCULATION Option**

<b>TEMP</b>	Results of the temperature conversion
<b>INPUT</b>	measurement before conversion
<b>AVERAGE</b>	statistical average of temperature
<b>STD DEV</b>	statistical standard deviation of
<b>MINIMUM</b>	statistical minimum of temperature
<b>MAXIMUM</b>	statistical maximum of temperature
<b>SPREAD</b>	statistical spread of temperature
<b>N</b>	number of samples

Each data field displays the results of the specified calculation type for the +CHANNEL input channel minus the results for the -CHANNEL input channel. For instance, if +CHANNEL is 2, -CHANNEL is 1, and CALCULATION is AVERAGE, the data field will show the average for input channel 2 minus the average for input channel 1. If either channel is specified as 0 it will be ignored for that part of the calculation. For instance, if +CHANNEL is 1, -CHANNEL is 0, and CALCULATION is INPUT, the data field will simply show the resistance or voltage for input channel 1. If both channels are 0 the data field will show 0. Measurements are displayed with the units, the channel number or numbers for difference calculations, and calculation type.

### 5.3.1.3 Graph Window

The **GRAPH WINDOW** soft-key selects the graph type window for viewing. The graph window shows a plot of measurements over time as shown in Figure 9. The graph type window plots all temperature measurements regardless of channel. The vertical axis scales automatically. The time scale for the graph depends on the DELAY setting of the **MEAS** function (see Section 5.1.1). The time scale, in minutes, is three times the DELAY setting or 6 whichever is larger. The graph is cleared using the **CLEAR GRAPH** function described next.

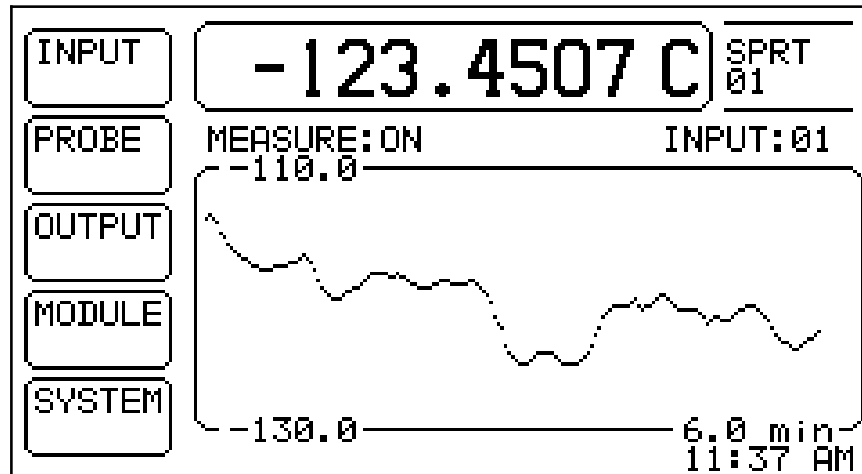

Figure 9. Typical Graph Window Display

### 5.3.1.4 Clear Graph

The **CLEAR GRAPH** soft-key clears the graph. Subsequent measurements are plotted starting from the far left side of the window.

### 5.3.1.5 Scrolling Window

The **SCROLL WINDOW** soft-key selects the scrolling type window for viewing. The scrolling window operates as a terminal screen, displaying each new measurement on the top line of the window and scrolling previous measurements down one line as shown below. Each line displays one measurement with the channel number, value, units, and time in 24-hour format (see Figure 10).

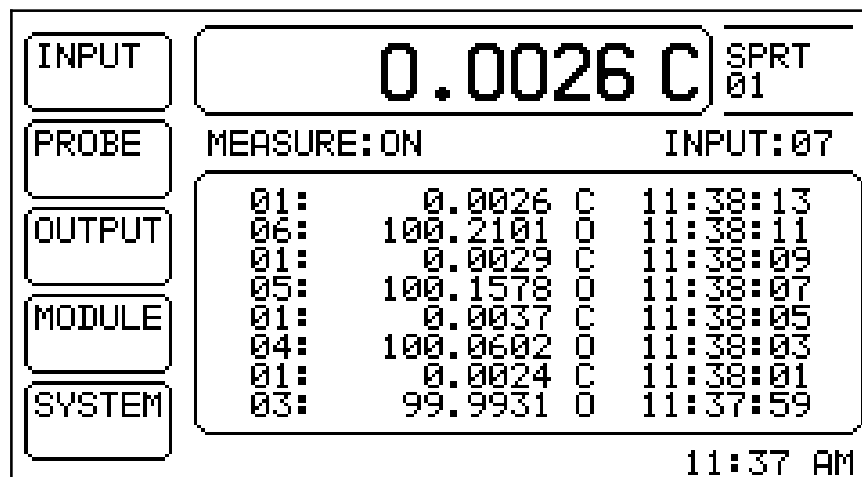



Figure 10. Typical Scrolling Display

### 5.3.2 Output Channel

The **OUTPUT CHAN** soft-key allows you to select the type of data sent to any output channel. First, you are requested to select the output channel. The channel is selected from a window showing a list of output channels. Each output channel is shown with the device name and channel number. The channel is selected using the   buttons and pressing **ENTER**.



```
SELECT AN OUTPUT CHANNEL
-----
>AOUT 02
```

After the channel is selected, a new window appears allowing you to select the data.

```
SELECT THE DATA FOR OUTPUT 01
-----
+CHANNEL: 1
-CHANNEL: 0
CALCULATION: TEMP

CHANNEL 0=NONE
CHANNEL 99=ALL
```





+CHANNEL specifies the input channel for the positive component of the difference calculation. -CHANNEL specifies the input channel for the negative component of the difference calculation. You may enter 0 to ignore that part of the calculation or 99 to apply the most recent measurement regardless of channel. Use the numeric buttons to enter a number and press **ENTER**.

CALCULATION specifies the type of calculation for which the results are displayed. The options are given in Table 4 above. The desired option is selected using the   buttons and pressing **ENTER**.

The value sent to the output channel is the result of the specified calculation type for the +CHANNEL input channel minus the results for the -CHANNEL input channel. For instance, if +CHANNEL is 2, -CHANNEL is 1, and CALCULATION is AVERAGE, the value will be the average for input channel 2 minus the average for input channel 1. If either channel is specified as 0 it will be ignored for that part of the calculation. For instance, if +CHANNEL is 1, -CHANNEL is 0, and CALCULATION is INPUT the value will simply be the resistance or voltage of input channel 1. If both channels are 0 no data will be output.

The calculation and transmission of data to any output channel occurs any time either of the specified input channels is measured.

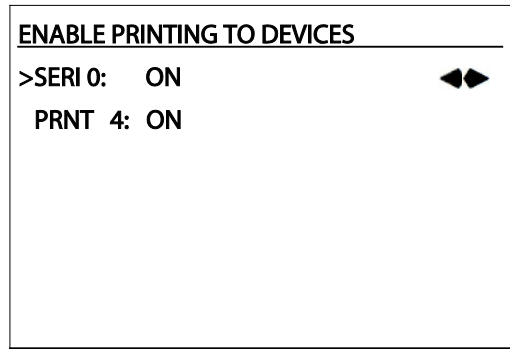

### 5.3.3 Print Output

The **PRINT OUTPUT** soft-key allows you to control the printing of measurements to any printer output device. A window appears allowing you to enable or disable printing to any printer device. You can scroll through the list using the   buttons. The indicated printer device can be toggled on or off using the   buttons. You do not need to press ENTER. Press EXIT to exit.



Each time a new measurement is produced and displayed on the screen in the primary output window it is also sent to all enabled printer devices. Each measurement is printed with the channel number, measurement value, unit prefix, unit, time (in 24-hour format), and date.

### 5.3.4 Print Memory

The **PRINT MEMORY** soft-key prints measurements stored in memory to any printer output device. Up to 1000 of the most recent measurements can be printed. (The storage capacity of the memory may be reduced if many input channels are added.) You are requested to select a printer device. You can scroll through the list using the   buttons. The indicated printer device is selected by pressing **ENTER**.

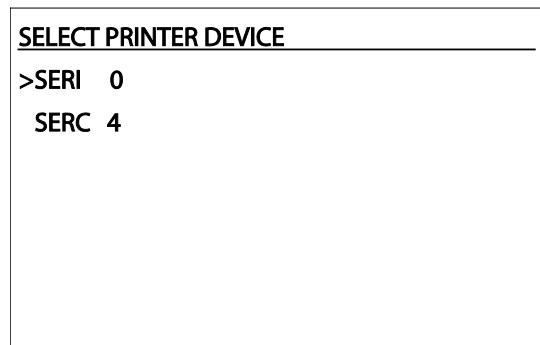

Next, you must enter the number of measurements to print. Use the numeric buttons to enter a value from 1 to 1000 and press **ENTER**.

ENTER THE NUMBER TO PRINT

PRINT N: 1

A message appears requesting you to press **ENTER** to begin printing. Press **ENTER** to continue or **EXIT** to abort. As the measurements are printed, a message window appears to indicate that printing is in process. You can cancel the operation at any time by pressing **EXIT**.

The last PRINT N number of measurements stored in memory will be printed to the selected output device. If the number of measurements available is less than the PRINT N number, only the available measurements will be printed. Printing the measurements from memory does not affect the data stored in memory. Each measurement is printed with the channel number, measurement value, unit prefix, unit, time (in 24-hour format), and date. Use the **SET UP DEVICE** soft-key function (see Section 5.4.2) to configure printer port options such as baud rate or linefeed enable.

### 5.3.5 **Clear Statistics**

The **CLEAR STATS** soft-key clears the statistical registers and resets all statistical calculations. Refer to Sections 5.3.1.1 and 5.3.1.2 to display statistical data. A message appears briefly at the bottom of the screen indicating the stats have been cleared.

## 5.4 **Module Menu**

The **MODULE** menu provides functions for setting module operating conditions, executing functions built in to the modules, setting module calibration parameters, executing module calibration routines, and viewing information relating to the modules. The soft-key functions that appear in this menu are **SET UP SCREEN**, **SET UP DEVICE**, **CAL DEVICE**, and **MODULE INFO**.

### 5.4.1 **Set up Screen**

The **SET UP SCREEN** soft-key function is used to set physical parameters relating to the screen such as brightness and screen saver.



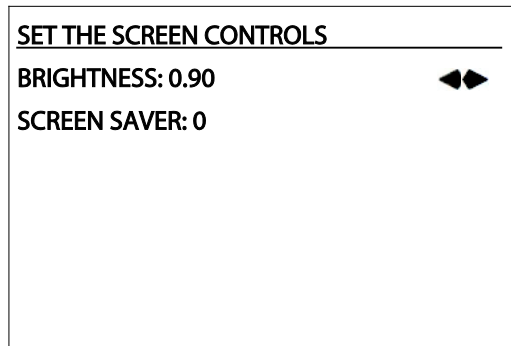

The ◀▶ buttons can be used to adjust the brightness. Pressing **ENTER** moves down to the screen saver parameter. You can enter a time period, in minutes, for the screen saver. The display backlight will turn off after this period of time if no activity occurs with the front panel buttons. Any button pressed restores the backlight. A value of 0 for the screen saver disables it. The range is 0 to 60 min.

#### 5.4.2 Set up Device

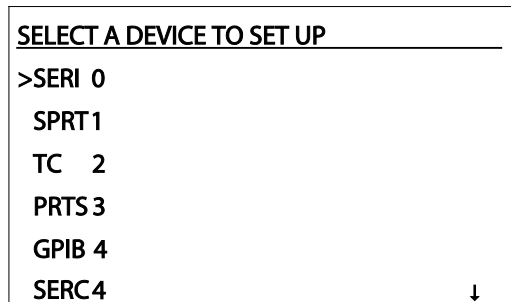

The **SET UP DEVICE** soft-key function is used for accessing parameters and functions contained within the add-on modules. First, you must select the device to set (remember a module may contain more than one independent device). A window appears showing a list of devices. The list includes the names of all devices including the internal serial communications device (SERI). Each device is followed by the address of the module that contains it. The device is selected using the ◀▶ buttons and pressing **ENTER**.

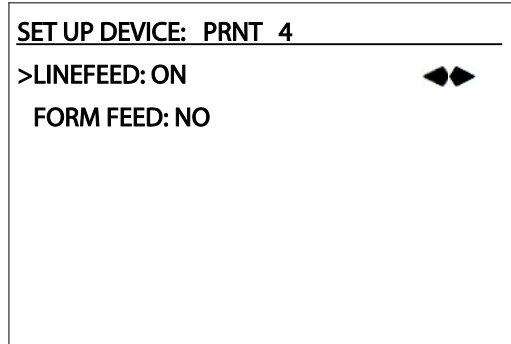

After the device is selected, another window appears showing the parameters and functions available from the device. These depend on the device. The set up device window might appear as follows:



If there are no setup commands for a particular device, the window shows “NO SETUP OPTIONS FOR THIS DEVICE.”

You can scroll through the setup parameters using the  buttons. The values of parameters can be changed using the numeric keys or the  buttons as is appropriate for the parameter type. Press **ENTER** to set the parameter.

With function commands you can use the  buttons to change “NO” to “YES” and then press **ENTER** to execute the function. If **ENTER** is pressed with “NO” nothing will happen except the cursor will move down to the next line. Press **EXIT** to exit.

### 5.4.3 Calibrate Device

The **CAL DEVICE** soft-key function is used for accessing module parameters and functions relating to device calibration. This function may be selectively locked out using the password feature (see Section 5.5.3 below). If the CAL DEVICE password option is set ON, in order to access this function you must enter the correct four-digit password. A screen appears requesting the password. Use the numeric keys and **ENTER** to enter the password. If the correct password is entered, the **CAL DEVICE** function continues.

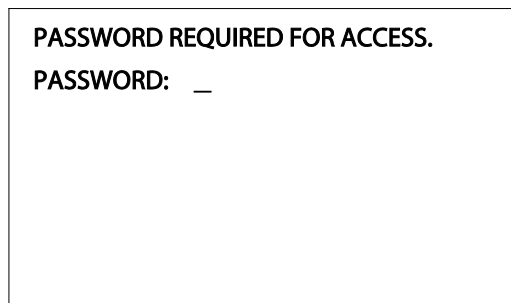





A window appears showing a list of devices. The list includes the names of all devices followed by the position number of the module to which it belongs. The device is selected using the  buttons and pressing **ENTER**.



```
SELECT A DEVICE TO CALIBRATE
-----
>SPRT 1
  TC   2
  PRTS 3
  GPIB 4
  PRNT 4
  AOUT 4
                                     ↓
```

After the device is selected, another window appears showing the parameters and functions available from the device. These depend on the device. The device calibration window might appear as follows:



```
CALIBRATE DEVICE: SPRT
-----
0 ADJ: 0.0
100 ADJ: 0.0
400 ADJ: 0.0
CAL DATE: 05-21-96
SER NUM: 123456
```

If there are no calibration commands for a particular device the window shows “NO CALIBRATION OPTIONS FOR THIS DEVICE.”

You can scroll through the calibration parameters using the   buttons. The values of parameters can be changed using the numeric keys or the   buttons as is appropriate for the parameter type. Press **ENTER** to set the parameter.

With function commands you can use the   buttons to change “NO” to “YES” and then press **ENTER** to execute the function. If **ENTER** is pressed with “NO” nothing will happen except the cursor will move down to the next line. Press **EXIT** to exit.



#### **5.4.4** *Module Information*

The **MODULE INFO** soft-key function displays information about a module. This includes the module name, model number, firmware version number, and the names of devices it contains with the class and number of channels for each device (remember a module may contain more than one independent device). First, you must select the module. A window appears showing a list of modules. Each module is followed by the module number. The module is selected using the   buttons and pressing **ENTER**.

```
SELECT A MODULE
-----
>SPRT 1 1
   TCS   2
   PRTS  3
   COMM  4
```

The information for the selected module then appears as follows:



```
SPRT MODULE, MODEL 2560
FIRMWARE VERSION: 1.10
DEVICES:
SPRT INPUT, 2 CHANNELS
```

The name of the module is given, followed by its model number. The next line shows the firmware version number for the module. Following this is a list of devices contained by the module. Each device is listed with its name, class (i.e. "INPUT", "OUTPUT", "PRINT", or "COMM"), and the number of channels it contains. If the list is too long to fit on one screen the   buttons can be used to scroll the list. Press **EXIT** or **ENTER** to exit.

## 5.5 System Menu

The SYSTEM menu provides general system functions. The soft-key functions that appear in this menu are **UNITS**, **TIME**, **PASSWORD**, **SYSTEM INFO**, and **SYSTEM RESET**.



### 5.5.1 Units

The **UNITS** soft-key is used to set the units for temperature measurements. The options are degrees Celsius (C), degrees Fahrenheit (F), or Kelvin (K). A window appears allowing you to set the units. The units are selected using the   buttons and pressing **ENTER**. Press **EXIT** to exit.

```
SELECT THE TEMPERATURE UNITS
-----
UNITS: C                               ◀▶
```

Measurements can also be displayed as resistance or voltage in ohms or volts. Use the CONVERSION options with the **EDIT PROBE** soft-key function in the **PROBE** menu to select resistance or voltage rather than temperature for a particular probe (see Section 5.2.1).

### 5.5.2 Time

The **TIME** soft-key is used to set the time-of-day clock. The time is displayed on the screen and printed with measurement data. A window appears allowing you to set the time and date. Use the numeric keys or the   buttons as appropriate for the parameter type. Press **ENTER** to set the value. Press **EXIT** to exit.



<b>SET THE TIME</b>
HOURS: 1_1
MINUTES: 14
AM/PM: AM
DAY: 1
MONTH: 1
YEAR: 99

### 5.5.3 Password

The **PASSWORD** soft-key function allows you to select menu password protection options and change the password. In order to access this function you must enter the current four-digit password. A screen appears requesting the password. The default password is "1560".

<b>PASSWORD REQUIRED FOR ACCESS.</b>
PASSWORD: _

Use the numeric keys and **ENTER** to enter the password. If the correct password is entered, the password settings window will appear allowing you to change any of the password options.

<b>SET PASSWORD OPTIONS</b>
>PROBE: OFF  
CAL DEVICE: ON
PASSWORD: 1560

The PROBE option controls access to the functions in the **PROBE** menu. If the option is ON, access to the PROBE menu requires you to enter the correct password. The default is OFF. You can change the option using the ◀▶ buttons and pressing **ENTER**.

The CAL DEVICE option controls access to the device calibration function in the MODULE menu. If the option is ON, access to the **CAL DEVICE** menu function requires you to enter the correct password. The default is ON. You can change the option using the ◀▶ buttons and pressing **ENTER**.

The PASSWORD option allows you to change the password. You can change the password by typing in a four-digit number using the numeric buttons '0' through '9' and pressing **ENTER**.

*Note*

*Be careful when changing the password. Make a note of your new password and keep it in a safe place in case you forget it.*

#### **5.5.4 System Information**

The **SYSTEM INFO** soft-key function displays system information as follows:

```
THE BLACK STACK
MODEL 1560
HART SCIENTIFIC
FIRMWARE VERSION: 1.20
MODULES:
SPRT-2560 ↓
```

The window shows the product name, model number, manufacturer, and firmware version number. It also shows a list of installed modules. The modules are listed one per line with the module name and model number. If the list is too long to fit on one screen the ◀▶ buttons can be used to scroll the list. Press **EXIT** or **ENTER** to exit.

### 5.5.5 System Reset

The SYSTEM RESET function resets operating parameters to default values. It has the following effects:

- Sets the measure mode to off.
- Sets the COUNT N number to 1.
- Sets the measure delay to 0.
- Sets the primary channel to input channel 1.
- Sets the scan channel list to include all channels.
- Sets the scan mode to primary channel.
- Sets input average to off.
- Disables routing to all output channels by setting the positive input channel number to 0, the negative input channel number to 0, and the calculation type to temperature.
- Sets printing to all printer interface devices to off.
- Clears the statistical functions.
- Sets units to C.

Reset does not affect any of the probe characterization parameters, module setup parameters, or module calibration parameters. A window will appear to warn you that parameters will be changed. Press **ENTER** to reset the parameters or press **EXIT** to cancel.

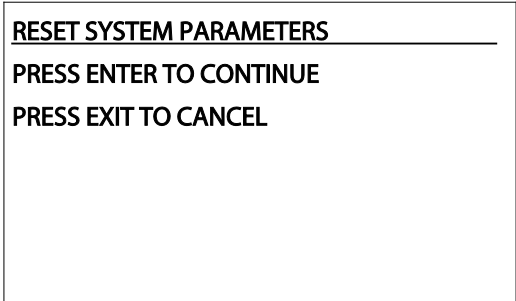

RESET SYSTEM PARAMETERS  
PRESS ENTER TO CONTINUE  
PRESS EXIT TO CANCEL





# Chapter 6

## Digital Communications Interface

### 6.1 Overview

External communications allows an external device, such as a computer, to communicate with the 1560 to obtain measurement data and control operating conditions. Communication is accomplished with various commands issued to the 1560 through any of its bi-directional communication ports. This may be through the RS-232 port, IEEE-488 port, or any other add-on module device designated as a communications class device.

### 6.2 Serial Interface

The 1560 includes one RS-232 serial port. It is located underneath the 1560. Wiring of the interface cable should be as shown in the diagram in Figure 11. The protocol for RS-232 communications is 8 data bits, 1 stop bit, and no parity.

The baud rate, duplex mode, and linefeed option are programmable. These parameters are accessed using the SET UP DEVICE soft-key in the MODULE menu. Select the SERIAL device and press ENTER. Use the **◀▶** buttons to change any of the parameters and press ENTER. BAUDRATE selects the data rate. It must match the data rate of the computer or external device. DUPLEX determines whether characters are immediately echoed back (FULL) to the transmitting device or not (HALF). LINEFEED determines whether a linefeed character is transmitted in addition to the carriage return character. All commands sent to the 1560 through the serial interface must be terminated with a carriage return or linefeed character.

**RS-232 Cable Wiring for IBM PC and Compatibles**

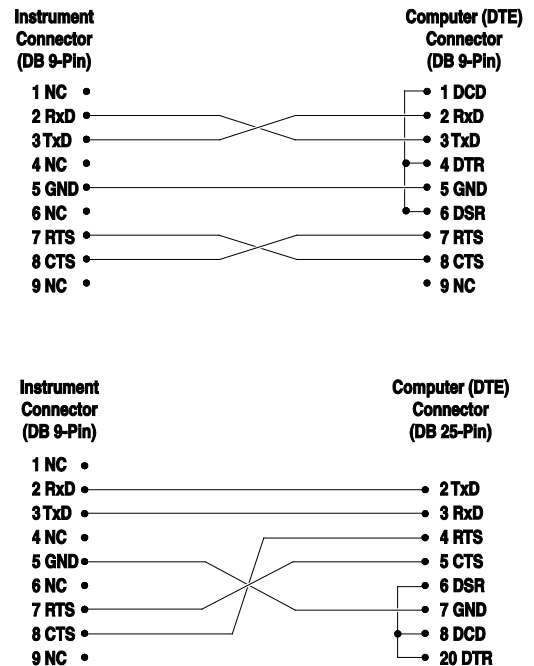

Figure 11. RS-232 Cable Wiring

## 6.3 Command Syntax

The 1560 accepts commands that set parameters execute functions or respond with requested data. These commands are in the form of strings of ASCII-encoded characters. As far as possible, the 1560 conforms to IEEE-488.2, 1992 and SCPI-1994. One notable exception is that compound commands are not allowed as explained below.

Commands consist of a command header and, if necessary, parameter data. All commands must be terminated with either a carriage return (ASCII 0D hex or 13 decimal) or newline character (ASCII 0A hex or 10 decimal).

Command headers consist of one or more mnemonics separated by colons (:). Mnemonics may use letter characters, the underscore character (`_`), and possibly numeric digits as well. There is no distinguishing between upper and lower case letters. Mnemonics often have alternate forms. Most mnemonics have a long form that is more readable and a short form consisting of three or four characters that is more efficient.

A mnemonic may end with a numeric suffix that specifies one of a set of independent function blocks such as input channel data paths. If a numeric suffix is omitted when a particular block must be specified, a suffix of one is assumed.

Query commands are commands that request data in response. Query commands have a question mark (?) immediately following the command header. Responses to query commands are generated immediately and placed in the output buffer. Responses will be lost if not read before the next command is received. The input and output buffers can each hold up to 100 characters.

Some commands require parameter data to specify values for one or more parameters. Parameter data follows the command header with a space (ASCII 20 hex or 32 decimal) between. Multiple parameters are separated by a comma (,).

Parameter data are of one of several types. Numeric data uses ASCII characters to represent numbers. Numbers may contain a sign ('+' or '-'), decimal point ('.'), and exponent ('E' or 'e') with its sign. If a fractional component is received when only an integer is required, the number is rounded to the nearest integer without any resulting error message. Some commands may accept a character mnemonic as a number. The mnemonics DEF, MIN, and MAX are often acceptable for the default, minimum, and maximum value respectively. Unit suffixes, such as V or OHM, can be appended to numeric parameters and are accepted without error but ignored.

Boolean parameters have the values of 0 or 1. The mnemonics OFF and ON are also accepted for 0 and 1 respectively.

Character data are mnemonics that represents one of several possible values. For instance, temperature units may be specified with CEL for Celsius or FAR for Fahrenheit.

String data consist of characters enclosed in double quotes. A null string consists of double quotes with no characters enclosed.

Unrecognized commands or commands with incorrect syntax or invalid parameters generate error messages in the error queue as explained in Section 6.5.10.22.

The 1560 does not allow compound commands (multiple commands per line separated with semicolons).

All commands are sequential. The execution of each command is completed before subsequent commands are processed.

## 6.4 Command Summary

An alphabetical listing of the commands implemented by the 1560 are shown in Table 5. All commands are available with the current firmware version. Some commands may not be available with previous versions. (See Section 5.5.4 to determine the version number using the **MODULE INFO** soft-key.) The section under which the command is explained is given for each command.

## 6.5 Commands

This section explains each of the commands that can be used with the 1560. The commands are arranged into the following groups:

- Measurement Data Commands
- Measurement Control Commands
- Input Channel Commands
- Probe Commands
- Output Channel Commands
- Printer Commands
- Communication Interface Commands
- Module Commands
- System Commands
- Status Commands

### 6.5.1 Measurement Data Commands

This group of commands deals with reading measurement data from the 1560. These commands are summarized in Table 9.

#### 6.5.1.1 CALCulate[n]:AVERage[n]:CLEar

This command clears the statistical functions of the specified channel. The CALCulate suffix number specifies the channel number. Its range is 1 to 96. If it is omitted it is assumed to be channel 1. The AVERage suffix number, if

**Table 5. Command Summary**

Command	Reference
*CLS	Section 6.5.10.1
*ESE < numeric_value >	Section 6.5.10.2
*ESE?	Section 6.5.10.3
*ESR?	Section 6.5.10.4
*IDN?	Section 6.5.9.1
*OPC	Section 6.5.10.5
*OPC?	Section 6.5.10.6
*OPT?	Section 6.5.9.2
*RST	Section 6.5.9.3
*SRE < numeric_value >	Section 6.5.10.7
*SRE?	Section 6.5.10.8
*STB?	Section 6.5.10.9
*TST?	Section 6.5.10.10
*WAI	Section 6.5.10.11
ABORT	Section 6.5.2.1
CALCulate[n]:AVERAge[n]:CLEar	Section 6.5.1.1
CALCulate[n]:AVERAge[n]:CLEar:ALL	Section 6.5.1.2
CALCulate[n]:AVERAge[n]:DATA?	Section 6.5.1.3
CALCulate[n]:AVERAge[n][:STATe]?	Section 6.5.1.4
CALCulate[n]:AVERAge[n]:TYPE?	Section 6.5.1.5
CALCulate[n]:CONVert:CATalog?	Section 6.5.4.1
CALCulate[n]:CONVert:COpy < channel >	Section 6.5.4.2
CALCulate[n]:CONVert:DATA?	Section 6.5.4.3
CALCulate[n]:CONVert:NAME < conversion_name >	Section 6.5.4.4
CALCulate[n]:CONVert:NAME?	Section 6.5.4.5
CALCulate[n]:CONVert:PARAmeter:CATalog?	Section 6.5.4.6
CALCulate[n]:CONVert:PARAmeter:VALue < parameter_name >, < numeric_value > [: < parameter_name >, < numeric_value > ...]	Section 6.5.4.7
CALCulate[n]:CONVert:PARAmeter:VALue? < parameter_name >	Section 6.5.4.8
CALCulate[n]:CONVert:PARAmeter:VALue? ALL	Section 6.5.4.9
CALCulate[n]:CONVert:SNUMber < serial_number >	Section 6.5.4.10
CALCulate[n]:CONVert:SNUMber?	Section 6.5.4.11
CALCulate[n]:CONVert:SRLow < sub-range_number >	Section 6.5.4.12
CALCulate[n]:CONVert:SRLow?	Section 6.5.4.13

**Table 5. Command Summary (Cont)**

Command	Reference
CALCulate[n]:CONVert:SRHigh < sub-range_number >	Section 6.5.4.14
CALCulate[n]:CONVert:SRHigh?	Section 6.5.4.15
CALCulate[n]:CONVert:TEST? < numeric_parameter >[, < numeric_parameter >]	Section 6.5.4.16
CONFigure[ < channel >]	Section 6.5.1.6
CONFigure?	Section 6.5.1.7
DATA[:DATA]:VALue? [MEM], < numeric_value >	Section 6.5.1.8
DATA:POINts?	Section 6.5.1.9
FETCh[:TEMPerature]? [ < channel >]	Section 6.5.1.10
HCOPy:ABORt	Section 6.5.6.1
HCOPy[:IMMediate] < printer_number >	Section 6.5.6.2
HCOPy:PRINter[n][:STATe] < Boolean >	Section 6.5.6.3
HCOPy:PRINter[n][:STATe]?	Section 6.5.6.4
INITiate:CONTInuous < Boolean >	Section 6.5.2.3
INITiate:CONTInuous?	Section 6.5.2.4
INITiate[:IMMediate]	Section 6.5.2.2
MEASure[:TEMPerature]? [ < channel >]	Section 6.5.1.11
OUTPut[n]:CALC < numeric_value >	Section 6.5.5.1
OUTPut[n]:CALC?	Section 6.5.5.2
OUTPut[n]:NCHannel < channel >	Section 6.5.5.3
OUTPut[n]:NCHannel?	Section 6.5.5.4
OUTPut[n]:PCHannel < channel >	Section 6.5.5.5
OUTPut[n]:PCHannel?	Section 6.5.5.6
OUTPut[n][:STATe] < Boolean >	Section 6.5.5.7
OUTPut[n][:STATe]?	Section 6.5.5.8
READ[:TEMPerature]?	Section 6.5.1.12
ROUTe:CLOSe < channel >	Section 6.5.3.1
ROUTe:CLOSe:STATe?	Section 6.5.3.2
ROUTe:PRIMary?	Section 6.5.3.3
ROUTe:SCAN:ALT	Section 6.5.3.4
ROUTe:SCAN:ALT?	Section 6.5.3.5
ROUTe:SCAN[:LIST] < channel_list >	Section 6.5.3.6
ROUTe:SCAN[:LIST]?	Section 6.5.3.7
ROUTe:SCAN:STATe < Boolean >	Section 6.5.3.8
ROUTe:SCAN:STATe?	Section 6.5.3.9
SENSe[n]:AVERAge:COUNT < numeric_value >	Section 6.5.2.5

**Table 5. Command Summary (Cont)**

Command	Reference
SENSe[n]:AVERage:COUNT?	Section 6.5.2.6
SENSe[n]:AVERage:DATA?	Section 6.5.1.13
SENSe[n]:AVERage[:STATe] < Boolean >	Section 6.5.2.7
SENSe[n]:AVERage[:STATe]?	Section 6.5.2.8
STATus:OPERation:CONDition?	Section 6.5.10.12
STATus:OPERation:ENABle < numeric_value >	Section 6.5.10.13
STATus:OPERation:ENABle?	Section 6.5.10.14
STATus:OPERation[:EVENT]?	Section 6.5.10.15
STATus:PRESet	Section 6.5.10.16
STATus:QUEStionable:CONDition?	Section 6.5.10.17
STATus:QUEStionable:ENABle < numeric_value >	Section 6.5.10.18
STATus:QUEStionable:ENABle?	Section 6.5.10.19
STATus:QUEStionable[:EVENT]?	Section 6.5.10.20
STATus:QUEue[:NEXT]?	Section 6.5.10.21
SYSTem:COMMunicate:SERial[:RECeive]:BAUD < numeric_value >	Section 6.5.7.1
SYSTem:COMMunicate:SERial[:RECeive]:BAUD?	Section 6.5.7.2
SYSTem:COMMunicate:SERial[:RECeive]:FDUPlex < Boolean >	Section 6.5.7.3
SYSTem:COMMunicate:SERial[:RECeive]:FDUPlex?	Section 6.5.7.4
SYSTem:COMMunicate:SERial[:RECeive]:LINefeed < Boolean >	Section 6.5.7.5
SYSTem:COMMunicate:SERial[:RECeive]:LINefeed?	Section 6.5.7.6
SYSTem:CONFigure:CDEVice?	Section 6.5.8.1
SYSTem:CONFigure:COMMunicate[n]:DADDRESS?	Section 6.5.8.2
SYSTem:CONFigure:COMMunicate[n]:MADDRESS?	Section 6.5.8.3
SYSTem:CONFigure:ICHannel?	Section 6.5.8.4
SYSTem:CONFigure:IDEVice?	Section 6.5.8.5
SYSTem:CONFigure:INPut[n]:DADDRESS?	Section 6.5.8.6
SYSTem:CONFigure:INPut[n]:MADDRESS?	Section 6.5.8.7
SYSTem:CONFigure:MNUMber?	Section 6.5.8.8
SYSTem:CONFigure:MODule[n]:DEVice[n]:INformation?	Section 6.5.8.9

**Table 5. Command Summary (Cont)**

Command	Reference
SYSTem:CONFigure:MODUle[n]:DNUMber?	Section 6.5.8.10
SYSTem:CONFigure:MODUle[n]:INFormation?	Section 6.5.8.11
SYSTem:CONFigure:OCHannel?	Section 6.5.8.12
SYSTem:CONFigure:ODEVice?	Section 6.5.8.13
SYSTem:CONFigure:OUTPut[n]:DADDRESS?	Section 6.5.8.14
SYSTem:CONFigure:OUTPut[n]:MADDRESS?	Section 6.5.8.15
SYSTem:CONFigure:PDEVice?	Section 6.5.8.16
SYSTem:CONFigure:PRINter[n]:DADDRESS?	Section 6.5.8.17
SYSTem:CONFigure:PRINter[n]:MADDRESS?	Section 6.5.8.18
SYSTem:DATE < year >, < month >, < day >	Section 6.5.9.4
SYSTem:DATE?	Section 6.5.9.5
SYSTem:ERRor?	Section 6.5.10.22
SYSTem:MODUle[n]:DEVice[n]:READ? < device_command >	Section 6.5.8.19
SYSTem:MODUle[n]:DEVice[n]:WRITe < device_command >[, < parameter >]	Section 6.5.8.20
SYSTem:SNUMber < serial_number >	Section 6.5.9.6
SYSTem:SNUMber?	Section 6.5.9.7
SYSTem:TIME < hour >, < minute >, < second >	Section 6.5.9.8
SYSTem:TIME?	Section 6.5.9.9
SYSTem:VERSion?	Section 6.5.9.10
TRIGger[:SEQuence]:COUNt < numeric_value >	Section 6.5.2.9
TRIGger[:SEQuence]:COUNt?	Section 6.5.2.10
TRIGger[:SEQuence]:DELay < numeric_value >	Section 6.5.2.11
TRIGger[:SEQuence]:DELay?	Section 6.5.2.12
TRIGger[:SEQuence]:TIMer < numeric_value >	Section 6.5.2.13
TRIGger[:SEQuence]:TIMer?	Section 6.5.2.14
UNIT:TEMPerature C CEL F FAR K	Section 6.5.9.11
UNIT:TEMPerature?	Section 6.5.9.12

**Table 6. Measurement Data Commands**

Command	Action
CALCulate[n]:AVERage[n]:CLEar	Clear the statistics functions for one channel
CALCulate[n]:AVERage[n]:CLEar:ALL	Clear the statistics functions for all channels
CALCulate[n]:AVERage[n]:DATA?	Return a statistical value for a channel
CALCulate[n]:AVERage[n][:STATe]?	Return the state of a statistical calculation
CALCulate[n]:AVERage[n]:TYPE?	Return the type of statistical calculation
CONFigure[ < channel >]	Select the input channel to measure
CONFigure?	Query measurement function
DATA[:DATA]:VALue? [MEM,] < numeric_value >	Return one measurement in memory
DATA:POINts?	Query the memory array size
FETCh[:TEMPerature]?	Return the most recent measurement
MEASure[:TEMPerature]? [ < channel >]	Acquire and return one new measurement
READ[:TEMPerature]?	Acquire and return one new measurement
SENSe[n]:AVERage:DATA?	Return resistance or voltage

given, is ignored as this command clears all the statistical functions for the specified channel regardless.

Example command: CALC3:AVER:CLE

#### 6.5.1.2 CALCulate[n]:AVERage[n]:CLEar:ALL

This command simultaneously clears the statistical functions for all channels. The CALCulate suffix number and AVERage suffix number, if given, are ignored as this command clears all the statistical functions for all channels regardless.

Example command: CALC:AVER:CLE:ALL

#### 6.5.1.3 CALCulate[n]:AVERage[n]:DATA?

This query command returns the value of a statistical calculation for a channel. The CALCulate suffix number specifies the input channel number. Its range is 1 to 96. If it is omitted it is assumed to be channel 1. The AVERage suffix number specifies the calculation type as shown in Table 10. If it is omitted it is assumed to be type 1 which is the average. The response is a single numeric value that is the most recent results of the specified calculation for the specified channel. The following example reads the standard deviation of measurements of input channel 3.



**Table 7. Statistical Calculation Types**

No:	Type	Keyword
1	average	AVER
2	Standard deviation	SDEV
3	minimum	MIN
4	maximum	MAX
5	spread	SPR
6	n	N

Example command: CALC3:AVER2: DATA?

Example response: 0.00017

#### 6.5.1.4 CALCulate[n]:AVERage[n][:STATe]?

This query command returns the state of the calculation. It is implemented for compatibility. It always returns 1 since the statistical calculations cannot be disabled with this instrument.

#### 6.5.1.5 CALCulate[n]:AVERage[n]:TYPE?

This query command returns the type of the calculation for the given type number. The CALCulate suffix number is optional and if given is ignored as all channels have the same statistical calculations. The AVERage suffix number specifies the type of the statistical calculation. The response corresponding to the type number is the character word shown in Table 5 under Keyword.

Example command: CALC:AVER2:TYPE?

Example response: SDEV

#### 6.5.1.6 CONFigure[ < channel >]

The CONF command is often used in multi-function instruments to set the measurement function and input channels. The 1560 has only one measurement function, temperature, but input channels can be selected using this command. It causes the following actions:

- Sets the measure mode to off (INITiate:CONTinuous OFF).
- Sets the COUNT N number to 1.
- Sets the DELAY time to 0.
- Sets the primary input channel to the specified channel.
- Sets the scan mode to primary channel.

If an input channel is specified, the primary channel is set to that channel and the scan mode is set to measure the primary channel only. If multiple channels are specified the first channel in the list is accepted as the primary channel and the others are ignored.

The < channel > parameter is enclosed in parentheses with the symbol @ following the opening parenthesis. For example, (@5) would be used to select input channel 5.

Example command: CONF (@3)

#### 6.5.1.7 CONFigure?

This query command returns the measurement type and input channel numbers. "TEMP" is returned for the measurement type showing that the measurement function of the 1560 is temperature. A list of selected channels follows. The response is in the following format:

"TEMP < channel\_list >"

The channel list is preceded with @ and enclosed in parentheses. Channel numbers are separated by commas. The returned channel list depends on the scan mode. If scanning is off, the primary channel number will be returned. If scanning is on the list of selected channels for scanning will be returned.

Example command: CONF?

Example response: "TEMP (@3)"

#### 6.5.1.8 DATA[:DATA]:VALue? [MEM,] < numeric\_value >

This command returns one measurement stored in memory at the specified location given by < numeric\_value >. The range of < numeric\_value > is 1 to 1000. (The actual storage capacity of memory may be less than 1000 depending on the number of input channels added.) Specifying the data array name, MEM, is optional. The measurement is returned with the following format:

< channel number >, < measurement value >,  
< units >, < year >, < month >, < day >, < hours >, < minutes >,  
< seconds >

Example command: DATA:VAL? 10

Example response: 3,0.0115,C,1996,3,12,11,43,22

#### 6.5.1.9 DATA:POINts? [MEM]

This query command returns the number of data points stored in memory. Specifying the data array name, MEM, is optional.

Example command: DATA:POIN?

Example response: 115

#### 6.5.1.10 *FETCh[:TEMPerature]? [< channel >]*

This query command returns the most recent measurement. If an input channel is specified the response is the most recent measurement for that channel. The < channel > number is preceded by @ and enclosed in parentheses. For example, (@5) would be used to select input channel 5. If multiple channels are specified, only the first channel in the list is accepted and the others are ignored. If no channel is specified this command returns the most recent measurement regardless of channel. Other parameters are accepted with this command for compatibility but are ignored. The FETC? command does not affect the measurement action as does the MEAS? and READ? commands explained below.

Example command: FETC? (@3)

Example response: 0.0127

#### 6.5.1.11 *MEASure[:TEMPerature]? [< channel >]*

This command allows you to select channels, acquire a new measurement, and receive the measurement data using just one command. It causes the following actions:

- Sets the measure mode to off (INITiate:CONTInuous OFF).
- Sets the COUNT N number to 1.
- Sets the DELAY time to 0.
- Sets the primary channel to the specified channel.
- Sets the scan mode to primary channel.
- Acquires one measurement (INITiate:IMMEDIATE), waiting until complete.
- Returns the value of the measurement.

If the channel number is omitted the current primary channel will be used. The < channel > number is preceded by @ and enclosed in parentheses. For example, (@5) would be used to select input channel 5.

Example command: MEAS? (@3)

Example response: 0.0127

#### 6.5.1.12 *READ[:TEMPerature]?*

This command begins a new measurement and responds with the measurement value when finished. For this instrument, it is equivalent to the MEAS? Command without a specified channel. It causes the following actions:

- Sets the measure mode to off (INITiate:CONTinuous OFF).
- Sets the COUNT N number to 1.
- Sets the DELAY time to 0.
- Sets the scan mode to primary channel.
- Acquires one measurement from the primary channel, waiting until complete.
- Returns the value of the measurement.

Example command: READ?

Example response: 0.0113

#### 6.5.1.13 *SENSe[n]:AVERage:DATA?*

This query command returns a measurement value from the input average block of a given input channel. The measurement is returned as a resistance or voltage rather than a converted temperature. The measurement value is an average of a number of previous measurements where the average number depends on the setting of the input average function (see Section 5.1.5). The input channel number is specified with the SENS suffix. If the channel number is omitted input channel 1 is assumed.

Example command: SENS3:AVER:DATA?

Example response: 100.0291

### 6.5.2 **Measurement Control Commands**

This group of commands deals with timing and action of the measurement process. These commands are summarized in Table 11.

#### 6.5.2.1 *ABORt*

This command cancels the measurement or sequence of measurements in process. If the measurement mode is continuous a new measurement will immediately be initiated. If the measurement mode is COUNT measuring will stop and the measurement mode will change to OFF.

Example command: ABOR

#### 6.5.2.2 *INITiate[:IMMediate]*

This command starts one measurement or a series of measurements if the COUNT number is greater than 1. It is equivalent to selecting COUNT for the MEASURE mode with the MEAS soft-key function in the INPUT menu. The measurement status indication on the display is updated to reflect any changes caused by the command. This command also sets the state of the INIT:CONT function described below to OFF. If measuring is already in process when this command is received no operation will occur and an "Init ignored" error (-213) will be reported.

Example command: INIT

**Table 8. Measurement Control Commands**

Command	Action
ABORt	Abort the measurement
INITiate[:IMMediate]	Start a series of COUNT N measurements
INITiate:CONTInuous < Boolean >	Set continuous measuring
INITiate:CONTInuous?	Query continuous measuring
SENSe[n]:AVERage:COUNT < numeric_value >	Set the count for input averaging
SENSe[n]:AVERage:COUNT?	Query the count for input averaging
SENSe[n]:AVERage[:STATe ] < Boolean >	Set averaging state ON or OFF
SENSe[n]:AVERage[:STATe ]?	Query averaging state
TRIGger[:SEQuence]:COUNT < numeric_value >	Set number of samples for COUNT N mode
TRIGger[:SEQuence]:COUNT?	Query number of samples for COUNT N mode
TRIGger[:SEQuence]:DELay < numeric_value >	Set measurement delay in seconds
TRIGger[:SEQuence]:DELay?	Query measurement delay
TRIGger[:SEQuence]:TIMer < numeric_value >	Set sequence timer value in seconds
TRIGger[:SEQuence]:TIMer? >	Query sequence timer value

**6.5.2.3 INITiate:CONTInuous < Boolean >**

This command starts continuous measurement if the < Boolean > parameter value is ON or 1 or stops measurement if the < Boolean > parameter value is OFF or 0. It is equivalent to selecting ON or OFF for the MEASURE parameter with the **MEAS** soft-key function in the **INPUT** menu. The measurement status indication on the display is updated to reflect any changes caused by the command. The 1560 is able to process new commands while measuring. The \*RST command sets the continuous measurement mode to OFF.

Example command: INIT:CONT ON

**6.5.2.4 INITiate:CONTInuous?**

This query command returns 1 if the measurement mode is continuous (MEASURE: ON in the MEAS soft-key function) and returns 0 if the measurement mode is OFF or COUNT.

Example command: INIT:CONT?

Example response: 1

#### 6.5.2.5 *SENSe:AVERage:COUNT* < numeric\_value >

This command sets the count for the moving average filter. It is equivalent to setting COUNT for the **AVER** function in the **INPUT** soft-key menu. The < numeric\_value > parameter must be a number between 1 and 10. The character values MIN (1), MAX (10), and DEF (4) are also accepted for the < numeric\_value > parameter. The \*RST command sets the average count to the default (4).

Example command: SENS:AVER:COUN 5

#### 6.5.2.6 *SENSe:AVERage:COUNT?*

This query command returns the count number for input averaging. The character values MIN, MAX, and DEF can be appended to the command to read the corresponding limits and default.

Example command: SENS:AVER:COUN?

Example response: 4

#### 6.5.2.7 *SENSe:AVERage[:STATe]* < Boolean >

This command disables or enables averaging. It is equivalent to setting the AVERAGE option in the **AVER** function in the **INPUT** soft-key menu. A < Boolean > parameter value of 1 or ON enables averaging and 0 or OFF disables it. The \*RST command sets averaging to OFF.

Example command: SENS:AVER:STAT ON

#### 6.5.2.8 *SENSe: AVERage[:STATe]?*

This query command returns 1 if input averaging is ON and 0 if it is OFF.

Example command: SENS:AVER:STAT?

Example response: 0

#### 6.5.2.9 *TRIGger[:SEQuence]:COUNT* < numeric\_value >

This command sets the number of measurements that are acquired when measurement is initiated with the INIT command. It is equivalent to setting the COUNT N value with the **MEAS** soft-key function in the **INPUT** menu. The < numeric\_value > parameter value has the range 1 to 32767. The command also accepts the words MIN (1), MAX (32767), and DEF (1) for the < numeric\_value > parameter. The \*RST command sets this value to 1.

Example command: TRIG:COUN 30

**6.5.2.10 TRIGger[:SEquence]:COUNt?**

This query command returns the measurement COUNT N value. The words MIN, MAX, and DEF can also be appended to the command to read the corresponding limits and default.

Example command: TRIG:COUN?

Example response: 1

**6.5.2.11 TRIGger[:SEquence]:DELay < numeric\_value >**

This command sets the minimum time period between measurements. It is equivalent to setting the DELAY value with the MEAS soft-key function in the INPUT menu. The < numeric\_value > parameter value has the range 0 to 32767. The command also accepts the words MIN (0), MAX (32767), and DEF (0) for the < numeric\_value > parameter. The \*RST command sets this value to 0.

Example command: TRIG:DEL 10

**6.5.2.12 TRIGger[:SEquence]:DELay?**

This query command returns the measurement DELAY period.

Example command: TRIG:DEL?

Example response: 0

**6.5.2.13 TRIGger[:SEquence]:TIMer < numeric\_value >**

This command sets the scan sequence timer. It is equivalent to setting the SEQ TIMER parameter with the MEAS soft-key Function in the INPUT menu. The < numeric\_value > has the range 0 to 10000. This command also accepts the words MIN (0), MAX (10000), and DEF (0) for the < numeric\_value >.

**6.5.2.14 TRIGger[:SEquence]:TIMer?**

This query command returns the value of the scan sequence timer. The words MIN, MAX, or DEF can also be appended to the command to read the corresponding limits and default.

**6.5.3 Input Channel Commands**

This group of commands deals with the selection of input channels. These commands are summarized in Table 12.

**Table 9. Input Channel Commands**

Command	Action
ROUTe:CLOSe < channel >	Select the primary channel
ROUTe:CLOSe:STATe?	Query the current channel number being measured
ROUTe:PRIMary?	Query primary channel number
ROUTe:SCAN:ALTerate < Boolean >	Set the scan/primary channel alternate mode
ROUTe:SCAN:ALTerate?	Query the alternate mode
ROUTe:SCAN[:LIST] < channel_list >	Select channels for scanning
ROUTe:SCAN[:LIST]?	Query scanning channels
ROUTe:SCAN:STATe < Boolean >	Enable or disable scanning
ROUTe:SCAN:STATe?	Query scanning

#### 6.5.3.1 ROUTe:CLOSe < channel >

This command selects the primary input channel. It is equivalent to setting the primary channel using the **PRIM CHAN** soft-key function in the **INPUT** menu. The < channel > parameter specifies the channel number. The channel number is preceded by @ and enclosed in parentheses. This command also sets the scan state to OFF (see Section 6.5.3.8) and the scanning alternate state to OFF (see Section 6.5.3.4). It does not affect the measure mode or INITiate state. The \*RST command sets the primary channel to channel 1.

Example command: ROUT:CLOS (@3)

#### 6.5.3.2 ROUTe:CLOSe:STATe?

This query command returns the number of the current input channel.

Example command: ROUT:CLOS:STAT?

Example response: 3

#### 6.5.3.3 ROUTe:PRIMary?

This query command returns the number of the primary channel.

Example command: ROUT:PRIM?

Example response: 1

#### 6.5.3.4 ROUTe:SCAN:ALternate < Boolean >

This command sets the scan alternate mode. It is equivalent to selecting between the PRIM CHAN and SCAN/PRIM options with the SCAN MODE function in the INPUT soft-key menu. A < Boolean > parameter value of 1 or ON enables scanning and selects the alternate scan mode where the primary channel is measured between each channel in the scan list. If the scan state (see Section 6.5.3.8 ) was previously off it will be set on. A value of 0 or OFF sets the scan state and scan alternate state off so that only the primary channel is measured. The \*RST command sets this to OFF.

Example command:ROUT:SCAN:ALT ON

#### 6.5.3.5 ROUTe:SCAN:ALternate?

This query command returns 1 if the alternate scan mode is ON and 0 otherwise.

Example command: ROUT:SCAN:ALT?

Example response: 0

#### 6.5.3.6 ROUTe:SCAN[:LIST] < channel\_list >

This command selects input channels for scanning. It is equivalent to selecting scan channels using the **SCAN CHAN** soft-key function in the **INPUT** menu. This command also sets the scanning state to ON (see Section 6.5.3.8 ) and the scanning alternate state to OFF (see Section 6.5.3.4 ). It does not affect the measure mode or INITiate state. The \*RST command sets the scan channel list to all channels selected.



The < channel\_list > parameter specifies a list of channels to scan. The channel list is preceded by @ and enclosed in parentheses. Channel numbers are separated by commas. A range can be specified using a colon between two channel numbers. For example, if you want to select channels 1, 3, 7, and 10 through 15 the list may appear as the (@1,3,7,10:15). If any channel number is greater than the actual number of channels it will be ignored. Channel numbers may appear in the list in any order. However, they will always be scanned from the lowest number to the highest.

Example command: ROUT:SCAN (@2,4)

#### 6.5.3.7 ROUTe:SCAN[:LIST]?

This query command returns the list of channels selected for scanning. The channel list is preceded by @ and enclosed in parentheses. Channel numbers are separated by commas. This command returns a list of channels selected for scanning regardless of whether or not scanning is enabled.

Example command: ROUT:SCAN?

Example response: (@2,3,4)

#### 6.5.3.8 ROUTe:SCAN:STATe < Boolean >

This command enables or disables input channel scanning. It is equivalent to selecting between the PRIM CHAN and SCAN options with the SCAN MODE function in the INPUT soft-key menu. A < Boolean > parameter value of 1 or ON enables scanning. This also disables the alternate scan mode (see Section 6.5.3.4 ) so that only the selected scan channels are measured. A value of 0 or OFF disables scanning so that only the primary input channel is measured. The \*RST command sets scanning to OFF.

Example command: ROUT:SCAN:STAT ON

#### 6.5.3.9 ROUTe:SCAN:STATe?

This query command returns 1 if the scan state is ON and 0 otherwise.

Example command: ROUT:SCAN:STAT?

Example response: 0

### 6.5.4 Probe Commands

This group of commands deals with temperature conversion and probe characterization. The commands are summarized in Table 13. None of the probe parameters are affected by the \*RST command.

**Table 10. Probe Command Summary**

Command	Action
CALCulate[n]:CONVert:CATalog?	Query available conversion types
CALCulate[n]:CONVert:COpy < channel >	Copy conversion parameters from another channel
CALCulate[n]:CONVert:DATA?	Query output of conversion block
CALCulate[n]:CONVert:NAME < convert_name >	Select the conversion type
CALCulate[n]:CONVert:NAME?	Query the conversion type
CALCulate[n]:CONVert:PARAmeter:CATalog?	Query a list of conversion parameters
CALCulate[n]:CONVert:PARAmeter:VALue < parameter_name>,<numeric_value > (; < parameter_name > , < numeric_value >...)	Set conversion parameter values
CALCulate[n]:CONVert:PARAmeter:VALue? < parameter_name >	Query the value of a conversion parameter
CALCulate[n]:CONVert:PARAmeter:VALue? ALL	Query the values of all conversion parameters
CALCulate[n]:CONVert:SNUMber < serial_number >	Set the probe serial number
CALCulate[n]:CONVert:SNUMber?	Query the probe serial number
CALCulate[n]:CONVert:SRLow < sub-range_number >	Select a low ITS-90 sub-range
CALCulate[n]:CONVert:SRLow?	Query the low ITS-90 sub-range
CALCulate[n]:CONVert:SRHigh < sub-range_number >	Select a high ITS-90 sub-range
CALCulate[n]:CONVert:SRHigh?	Query the high ITS-90 sub-range
CALCulate[n]:CONVert:TEST? < numeric_parameter > (< , < numeric_parameter >)	Test the conversion calculation

#### 6.5.4.1 CALCulate[n]:CONVert:CATalog?

This query command returns a list of conversion types available for the given input channel. The channel number is given by the CALC suffix n. The response list gives the names of the conversion types as strings (enclosed in double quotes) separated by commas. The available conversion types depend on the type of module to which the channel belongs. Table 14 lists the names of conversion types available with each input module type.

Example command: CAL2:CONV:CAT?

Example response:

"I90", "RES", "W", "I68", "CVD", "POLY"

**Table 11. Conversion Type Mnemonics**

Input Type	Conversion types	Mnemonic
PRT/SPRT	ITS-90 (default)	I90
	R( $\Omega$ )	RES
	W(T90)	W
	IPTS-68	I68
	CVD	CVD
	POLYNOMIAL	POLY
Thermistor	THRM-R(T) (default)	TRES
	R( $\Omega$ )	RES
	THRM-T(R)	TTEM
	POLYNOMIAL	POLY
2564 module	ITS-90	I90
	R( $\Omega$ )	RES
	W(T90)	W
	ITPS-68	I68
	CVD	CVD
	POLYNOMIAL	POLY
	THRM-R(T)	TRES
	THRM-T(R)	TTEM
Thermocouple	TC-K (default)	K
	VOLTS	VOLT
	TC-B	B
	TC-E	E
	TC-J	J
Input Type	Conversion types	Mnemonic
	TC-N	N
	TC-R	R
	TC-S	S
	TC-T	T
	TC-AU/PT	AUPT
	TABLE	TABL
	POLYNOMIAL	POLY
Others	NONE	NONE
	POLYNOMIAL	POLY

#### 6.5.4.2 *CALCulate[n]:CONVert:COpy < channel >*

This command copies the conversion type, sub-ranges (ITS-90), serial number, and characterization coefficients from another channel. The destination channel number is given by the CALC suffix n. If the channel number is omitted input channel 1 is assumed. The source channel number is given by the < channel > parameter. If the input types of the two channels are incompatible, an "Incompatible type" error ( -294) is generated. Copying parameters does not affect the parameters of the source channel. The following example copies all probe parameters from input channel 1 to input channel 2.

Example command: CALC2:CONV:COpy 1

#### 6.5.4.3 *CALCulate[n]:CONVert:DATA?*

This query command returns the most recent temperature measurement for the given input channel number. The channel number is given by the CALC suffix n.

Example command: CALC2:CONV:DATA?

Example response: 0.0113

#### 6.5.4.4 *CALCulate[n]:CONVert:NAME < conversion\_name >*

This command selects the conversion type by name for the given input channel number. The channel number is given by the CALC suffix n. The < conversion\_name > is a mnemonic indicating the conversion type. It should not be enclosed in quotes. The acceptable conversion types depend on the type of module to which the input channel belongs. Conversion types and their names are listed in Table 14. DEF can be used as the conversion name to select the default conversion type.

Example command: CALC2:CONV:NAME I90

**Table 12. Conversion Parameters**

Conversion name	Parameters
I90, range 0 (none)	RTPW
I90, low range 1	RTPW, A1, B1, C1, C2, C3, C4, C5
I90, low range 2	RTPW, A2, B2, C1, C2, C3
I90, low range 3	RTPW, A3, B3, C1
I90, low range 4	RTPW, A4, B4
I90, low range 5	RTPW, A5, B5
I90, high range 6	RTPW, A6, B6, C6, D
I90, high range 7	RTPW, A7, B7, C7
I90, high range 8	RTPW, A8, B8
I90, high range 9	RTPW, A9, B9
I90, high range 10	RTPW, A10
I90, high range 11	RTPW, A11
W	RTPW
I68	R0, ALPH, DELT, A4, C4
CVD	R0, ALPH, DELT, BETA
POLY	A0, A1, A10
TRES	B0, B1, B2, B3
TTEM	A0, A1, A2, A3
POLY	A0, A1, .A10
K	CJC, CJCT, POIN, T1, ADJ1, T2, ADJ2, T3, ADJ3
B	CJC, CJCT, POIN, T1, ADJ1, T2, ADJ2, T3, ADJ3
E	CJC, CJCT, POIN, T1, ADJ1, T2, ADJ2, T3, ADJ3
J	CJC, CJCT, POIN, T1, ADJ1, T2, ADJ2, T3, ADJ3
N	CJC, CJCT, POIN, T1, ADJ1, T2, ADJ2, T3, ADJ3
R	CJC, CJCT, POIN, T1, ADJ1, T2, ADJ2, T3, ADJ3, DC1, DC2
S	CJC, CJCT, POIN, T1, ADJ1, T2, ADJ2, T3, ADJ3, DC1, DC2
T	CJC, CJCT, POIN, T1, ADJ1, T2, ADJ2, T3, ADJ3
AUPT	CJC, CJCT, POIN, T1, ADJ1, T2, ADJ2, T3, ADJ3, DC1, DC2
TABL	CJC, CJCT, POIN, T1, V1, T2, V2, T10, V10
POLY	CJC, CJCT, C0, C1, C15
POLY	A0, A1, A10

#### 6.5.4.5 *CALCulate[n]:CONVert:NAME?*

This query command returns the name of the selected conversion type for the given input channel number. The channel number is given by the CALC suffix n. Conversion types and their names are listed in Table 14. The returned name is not enclosed in quotes.

Example command: CALC2:CONV:NAME?

Example response: I90

#### 6.5.4.6 *CALCulate[n]:CONVert:PARAmeter:CATalog?*

This query command returns the names of probe characterization parameters used with the selected conversion type for the given input channel number. The channel number is given by the CALC suffix n. The response list gives the names of the characterization parameters as strings (enclosed in double quotes) separated by commas. If no parameters are available with the selected conversion type, an empty string, "", is returned. The list of parameters depends on the selected conversion type. Characterization parameters for the various conversion types are listed in Table 3. For the ITS-90 conversion, the list also depends on the selected sub-ranges (see Section 6.5.4.12 and 6.5.4.14).

Example command: CALC2:CONV:PAR:CAT?

Example response: "A4","B4","A7","B7","C7"

#### 6.5.4.7 *CALCulate[n]:CONVert:PARAmeter:VALue < parameter\_name >, < numeric\_value >[, < parameter\_name >, < numeric\_value > . . . ]*

This command sets the values of one or more conversion parameters for the given input channel number. The channel number is given by the CALC suffix n. The < parameter\_name > is the name of a parameter (see Table 15). It should not be enclosed in quotes. If the given parameter name is not acceptable with the selected conversion type, a "Settings conflict" error (-221) is generated. The < numeric\_value > is the desired value of the parameter. DEF is also accepted to set a parameter to its default value. For the CJC parameter, possible values are 0 for internal and 1 for external. Multiple parameters can be set with one command using a comma to separate the parameter names. The order of parameters is not important but the value must always immediately follow the parameter name.

Example command: CALC2:CONV:PAR:VAL

RTPW,100.0145,A8,-3.2878E-4,B8,-1.894E-5

**6.5.4.8** *CALCulate[n]:CONVert:PARAmeter:VALue? < parameter\_name >*

This query command returns the value of the specified conversion parameter for the given input channel number. The channel number is given by the CALC suffix n. The < parameter\_name > is the name of the parameter as given in Table 15. It should not be enclosed in quotes. If the given parameter name is not acceptable with the selected conversion type, a “Settings conflict” error (–221) is generated.

Example command: CALC2:CONV:PAR:VAL? RTPW

Example response: 100.0145

**6.5.4.9** *CALCulate[n]:CONVert:PARAmeter:VALue? ALL*

This query command returns the values of all conversion parameters for the given input channel number. The channel number is given by the CALC suffix n. Returned values are preceded by the parameter name and a separating comma. Parameter names are presented as strings (enclosed in quotes). If there are no parameters for the given channel, an empty string, “”, is returned.

Example command: CALC2:CONV:PAR:VAL? ALL

Example response: “RTPW”,100.0145,”A8”,  
–3.2878E-4,”B8”, –1.894E-5

**6.5.4.10** *CALCulate[n]:CONVert:SNUMber < serial\_number >*

This command sets the probe serial number for the given input channel number. The channel number is given by the CALC suffix n. The < serial\_number > parameter is a string (enclosed in quotes) representing the serial number of the probe. It can consist of up to eight characters that include any letters, numeric digits, decimal points, and minus signs.

Example command: CALC2:CONV:SNUM “4-336C”

**6.5.4.11** *CALCulate[n]:CONVert:SNUMber?*

This query command returns the probe serial number for the given input channel number. The channel number is given by the CALC suffix n. The returned serial number is in string format (enclosed in quotes).

Example command: CALC2:CONV:SNUM?

Example response: “4-336C”

**6.5.4.12** *CALCulate[n]:CONVert:SRLOW < sub-range\_number >*

This command selects one of the ITS-90 low sub-ranges for the given input channel number. The channel number is given by the CALC suffix n. The < subrange\_number > is 0 through 5. 0 sets the sub-range to NONE. If the ITS-90 conversion is not selected for the given channel number, a “Settings conflict” error (–221) is generated.

Example command: CALC2:CONV:SRLOW 4

#### 6.5.4.13 *CALCulate[n]:CONVert:SRLow?*

This query command returns the selected ITS-90 low sub-range for the given input channel number. The channel number is given by the CALC suffix *n*. The returned sub-range is a number from 0 to 5. If the ITS-90 conversion is not selected for the given channel number, a "Settings conflict" error ( -221) is generated.

Example command: CALC2:CONV:SRLOW?

Example response: 4

#### 6.5.4.14 *CALCulate[n]:CONVert:SRHigh < sub-range\_number >*

This command selects one of the ITS-90 high sub-ranges for the given input channel number. The channel number is given by the CALC suffix *n*. The *< sub-range\_number >* is 0 or 6 through 11. 0 sets the sub-range to NONE. If the ITS-90 conversion is not selected for the given channel number, a "Setting conflict" error ( -221) is generated.

Example command: CALC2:CONV:SRH 7

#### 6.5.4.15 *CALCulate[n]:CONVert:SRHigh?*

This query command returns the selected ITS-90 low sub-range for the given input channel. The channel number is given by the CALC suffix *n*. The returned sub-range is 0 or 6 through 11. If the ITS-90 conversion is not selected for the given channel number, a "Setting conflict" error ( -221) is generated.

Example command: CALC2:CONV:SRH?

Example response: 7

#### 6.5.4.1 *CALCulate[n]:CONVert:TEST? < numeric\_value >[, < numeric\_value >]*

This query command is used to test the temperature conversion for the given input channel number. It returns the temperature corresponding to the given resistance or voltage. Temperature is calculated using the selected system temperature units. The channel number is given by the CALC suffix *n*. The resistance or voltage is specified using the first *< numeric\_value >* parameter. The second *< numeric\_value >* parameter can be used to specify a CJC temperature for thermocouple conversions. It is ignored if internal CJC is specified. If it is omitted when external CJC is specified, a value of 0 is assumed.

Example command: CALC2:CONV:TEST? 100.0145

Example response: 0.0100



### 6.5.5 Output Channel Commands

This group of commands controls the output of data to output channels. They are summarized in Table 16.

**Table 13 Output Channel Commands**

Command	Action
OUTPut[n]:CALC < numeric_value >	Select calculation type for an output channel
OUTPut[n]:CALC?	Query calculation type for an output channel
OUTPut[n]:NCHannel < channel >	Select negative input channel for an output channel
OUTPut[n]:NCHannel?	Query negative input channel for an output channel
OUTPut[n]:PCHannel < channel >	Select positive input channel for an output channel
OUTPut[n]:PCHannel?	Query positive input channel for an output channel
OUTPut[n]::STATe] < Boolean >	Enable or disable output channel
OUTPut[n]::STATe]?	Query state of output channel

#### 6.5.5.1 OUTPut[n]:CALC < numeric\_value >

This command selects the calculation type for which results are output to a given output channel. It is equivalent to setting CALCULATION with the OUTPUT CHAN soft-key function (see Section 5.3.2 ). The output channel number is given by the OUP suffix n. If it is omitted output channel 1 is assumed. The command SYST:CONF:OCH? (Section 6.5.8.12) can be used to determine the number of installed output channels. The < numeric\_value > specifies the calculation type according to Table 17. The \*RST command sets the calculation type to 0 (temperature) for all output channels.

Example command: OUTP1:CALC 0

#### 6.5.5.2 OUTPut[n]:CALC?

This query command returns the calculation type for a given output channel. The output channel number is given by the OUP suffix n. If it is omitted output channel 1 is assumed. The response is a number showing the calculation type (see Table 17).

Example command: OUTP1:CALC?

Example response:0

Table 14. Output Calculation Types

Number	Type
0	temperature
1	average
2	standard deviation
3	minimum
4	maximum
5	spread
6	n
7	input

**6.5.5.3 OUTPut[n]:NCHannel < channel >**

This command selects the input channel routed to the negative path of the output channel. It is equivalent to setting -CHANNEL with the **OUTPUT CHAN** soft-key function (see Section 5.3.2). The output channel number is given by the OUTP suffix n. If it is omitted output channel 1 is assumed. The input channel number is given by the <channel> parameter. The channel number is preceded by @ and enclosed in parentheses. For example, (@2) would be used to select input channel 2. Use (@) to specify no input channel. This command also sets the OUTPut:STATe to ON (see Section 6.5.5.7). The \*RST command sets the negative channel to none for all output channels.

Example command: OUTP1:NCH (@2)

**6.5.5.4 OUTPut[n]:NCHannel?**

This query command returns the input channel routed to the negative path of the output channel. The output channel number is given by the OUTP suffix n. If it is omitted output channel 1 is assumed. The returned channel number is preceded by @ and enclosed in parentheses. If no channel is selected (@) is returned.

Example command: OUTP1:NCH?

Example response: (@2)

#### 6.5.5.5 *OUTPut[n]:PCHannel < channel >*

This command selects the input channel routed to the positive path of the output channel. It is equivalent to setting +CHANNEL with the **OUTPUT CHAN** menu function (see Section 5.3.2). The output channel number is given by the OUP suffix n. If it is omitted output channel 1 is assumed. The input channel number is given by the < channel > parameter. The channel number is preceded by @ and enclosed in parentheses. For example, (@2) would be used to select input channel 2. Use (@) to specify no input channel. This command also sets the OUTPut:STATE to ON (see Section 6.5.5.7). The \*RST command sets the positive channel to none for all output channels.

Example command: OUP1:PCH (@1)

#### 6.5.5.6 *OUTPut[n]:PCHannel?*

This query command returns the input channel routed to the positive path of the output channel. The output channel number is given by the OUP suffix n. If it is omitted output channel 1 is assumed. The returned channel number is preceded by @ and enclosed in parentheses. If no channel is selected (@) is returned.

Example command: OUP1:PCH?

Example response: (@1)

#### 6.5.5.7 *OUTPut[n]:STATE < Boolean >*

This command enables or disables output to the given output channel. The output channel number is given by the OUP suffix n. If it is omitted output channel 1 is assumed. Giving a < Boolean > parameter value of OFF or 0 sets both +CHANNEL and -CHANNEL to none or 0. Giving a < Boolean > parameter value of ON or 1 sets the +CHANNEL to the primary input channel and -CHANNEL to none or 0. The \*RST command sets all output channels OFF.

Example command: OUP1 OFF

#### 6.5.5.8 *OUTPut[n]:STATE?*

This query command returns the state of the given output channel. The output channel number is given by the OUP suffix n. If it is omitted output channel 1 is assumed. The response is 1 if output to the channel is enabled (either +CHANNEL or -CHANNEL is set) or 0 if disabled.

Example command: OUP1?

Example response: 0

### 6.5.6 Printer Commands

This group of commands controls output to printer devices.

Table 15. Printer Commands

Command	Action
HCOPy:ABORt	Cancel printing of memory data
HCOPy:IMMediate] <printer_number>,<numeric_value>	Print data in memory to printer device
HCOPy:PRINter[n]:STATe] <Boolean>	Enable or disable data output to printer
HCOPy:PRINter[n]:STATe?]	Query printer output state

#### 6.5.6.1 HCOPy:ABORt

This command cancels the printing of memory data initiated with the HCOP:IMM command.

Example command: HCOP:ABOR

#### 6.5.6.2 HCOPy:IMMediate] < printer\_number >, < numeric\_value >

This command initiates printing of memory data to the given printer device. This is equivalent to using the **PRINT MEMORY** menu function (see Section 5.3.4). The printer device number is given by < printer\_number >. Printer device 1 is the serial port on the base. Other printer devices are assigned numbers sequentially. The command SYST:CONF:PDEV? (Section 6.5.8.16 ) can be used to determine the number of installed printer devices. The number of measurements to print is specified with < numeric\_value >. MAX can be used to print all data. If the given number is larger than the number of measurements stored in memory a "Data out of range" error ( -222) is reported. The number of available measurements can be determined using the DATA:POIN? command (Section 6.5.1.9). Printing can be canceled with the HCOPy:ABOR command (see above). Measurements are printed one measurement per line with the channel number, measurement value, unit, time, and date. Use the appropriate communication commands (Section 6.5.7) or device setup commands (Section 6.5.8.20) to configure printer port options such as baud rate or linefeed enable. The following example prints the 10 most recent measurements stored in memory to the base serial port.

Example command: HCOP 1,10

#### 6.5.6.3 HCOPy:PRINter[n]:STATe] < Boolean >

This command enables or disables output of measurement data to printer devices. This is equivalent to using the **PRINT OUTPUT** menu function (see Section 5.3.3). When printing is enabled all measurement data are printed as they are acquired. The printer device number is given by the PRIN suffix n. If it is omitted printer port 1, the base serial port, is assumed. Printer devices are assigned numbers sequentially starting with 1 for the base serial port. The command SYST:CONF:PDEV? (Section 6.5.8.16) can be used to query the number of installed printer devices. Giving a < Boolean > parameter value of ON or 1 enables printing and OFF or 0 disables printing. Measurements are printed one measurement per line with the channel number, measurement value, unit, time, and date. Use the appropriate communication commands (Section 6.5.7) or device setup commands (Section 6.5.8.20) to configure printer port options such as baud rate or linefeed enable. The \*RST command sets all printer devices OFF.

Example command: HCOP:PRIN ON

#### 6.5.6.4 *HCOPy:PRINter[n]:STATe?*

This query command returns the state of the given printer device. The printer device number is given by the PRIN suffix n. If it is omitted printer port 1, the base serial port, is assumed. The response is 1 if printing to the device is enabled or 0 if disabled.

Example command: HCOP:PRIN?

Example response: 1

### 6.5.7 **Communication Interface Commands**

This group of commands (Table 19) controls the base serial port configuration options. Configuration of add-on communication ports is done using the SYST:MOD:DEV:WRIT command as explained in Section 6.5.8.20.

#### 6.5.7.1 *SYSTem:COMMunicate:SERial[:RECeive]:BAUD <numeric\_value>*

This command sets the baud rate of the base serial port. The <numeric\_value> parameter specifies the desired baud rate. The nearest possible baud rate will be selected. The baud rate is not affected by the \*RST command.

Example command: SYST:COMM:SER:BAUD 2400

#### 6.5.7.2 *SYSTem:COMMunicate:SERial[:RECeive]:BAUD?*

This query command returns the baud rate of the base serial port.

Example command: SYST:COMM:SER:BAUD?

Example response: 2400

#### 6.5.7.3 *SYSTem:COMMunicate:SERial[:RECeive]:FDUPlex < Boolean >*

This command sets the duplex or echo mode of the base serial port. The < Boolean > parameter turns on or off full duplex. A value of 1 or ON turns full duplex on and 0 or OFF turns it off. If full duplex is ON, all characters received will be echoed back. Duplex is not affected by the \*RST command.

Example command: SYST:COMM:SER:FDUP OFF

#### 6.5.7.4 SYSTem:COMMunicate:SERial[:RECeive]:FDUP?

This query command returns the duplex or echo mode of the base serial port. This command returns 1 if full duplex is on and 0 otherwise.

**Table 16. Communication Interface Commands**

Command	Action
SYSTem:COMMunicate:SERial[:RECeive]:BAUD<numeric_value>	Set the baud rate for the base serial port
SYSTem:COMMunicate:SERial[:RECeive]:BAUD?	Query the baud rate for the base serial port
SYSTem:COMMunicate:SERial[:RECeive]:FDUPlex	Select duplex (echo) mode for the base serial port
SYSTem:COMMunicate:SERial[:RECeive]:FDUP?	Query duplex (echo) mode for the base serial port
SYSTem:COMMunicate:SERial[:RECeive]:LINefeed <Boolean>	Enable or disable linefeed for the base serial port
SYSTem:COMMunicate:SERial[:RECeive]:LINefeed ?	Query linefeed for the base serial port

Example command: SYST:COMM:SER:FDUP?

Example response: 0

#### 6.5.7.5 SYSTem:COMMunicate:SERial[:RECeive]:LINefeed <Boolean>

This command enables or disables linefeed for the base serial port. A < Boolean > value of 1 or ON turns the linefeed on and 0 or OFF turns it off. If the linefeed is ON, a linefeed character (ASCII decimal 10) will be appended to the carriage return at the end of each line during transmission. Linefeed is not affected by the \*RST command.

Example command:SYST: COMM:SER:LIN ON

#### 6.5.7.6 SYSTem:COMMunicate:SERial[:RECeive]:LINefeed?

This query command returns the state of the linefeed for the base serial port. It returns 1 if the linefeed is on and 0 otherwise.

Example command: SYST:COMM:SER:LIN?

Example response: 1

### 6.5.8 Module Commands

This group of commands (Table 20) can be used to determine the module configuration and to communicate directly with module devices.

**Table 17. Module Commands**

Command	Action
SYSTem:CONFigure:CDEvice?	Query number of communication devices
SYSTem:CONFigure:COMMunicate[n]:DADDRESS?	Query device address of communication device
SYSTem:CONFigure:COMMunicate[n]:MADDRESS?	Query module address of communication device
SYSTem:CONFigure:ICHannel?	Query number of input channels
SYSTem:CONFigure:IDEvice?	Query number of input devices
SYSTem:CONFigure:INPut[n]:DADDRESS?	Query device address of input device
SYSTem:CONFigure:INPut[n]:MADDRESS?	Query module address of input device
SYSTem:CONFigure:MNUMBER?	Query number of modules
SYSTem:CONFigure:MODule[n]:DEvice[n]:INformation?	Query device information
SYSTem:CONFigure:MODule[n]:DNUMBER?	Query number of devices in module
SYSTem:CONFigure:MODule[n]:INformation?	Query module information
SYSTem:CONFigure:OChannel?	Query number of output channels
SYSTem:CONFigure:ODEvice?	Query number of output devices
SYSTem:CONFigure:OUTPut[n]:DADDRESS?	Query device address of output device
SYSTem:CONFigure:OUTPut[n]:MADDRESS?	Query module address of output device
SYSTem:CONFigure:PDEvice?	Query number of printer devices
SYSTem:CONFigure:PRINter[n]:DADDRESS?	Query device address of printer device
SYSTem:CONFigure:PRINter[n]:MADDRESS?	Query module address of printer device
SYSTem:MODule[n]:DEvice[n]:READ?	Read data from a module device
SYSTem:MODule[n]:DEvice[n]:WRITE	Write data to a module device

**6.5.8.1 SYSTem:CONFigure:CDEvice?**

This query command returns the number of installed communication devices.

Example command: SYST:CONF:CDEV?

Example response: 3

#### **6.5.8.2 SYSTem:CONFigure:COMMunicate[n]:DADdress?**

This query command returns the device address (number of the device within its module) of a given communication device. The communication device number is given by the COMM suffix n. Communication devices are assigned numbers sequentially starting with 1 for the base serial port. The command SYST:CONF:CDEV? can be used to determine the number of installed communication devices.

Example command: SYST:CONF:COMM3:DADD?

Example response: 2

#### **6.5.8.3 SYSTem:CONFigure:COMMunicate[n]:MADdress?**

This query command returns the module number or address of the module that contains a given communication device. The communication device number is given by the COMM suffix n. Communication devices are assigned numbers sequentially starting with 1 for the base serial port. The command SYST:CONF:CDEV? can be used to query the number of installed communication devices.

Example command: SYST:CONF:COMM3:MADD?

Example response: 3

#### **6.5.8.4 SYSTem:CONFigure:ICHannel?**

This query command returns the total number of installed input channels.  
Example command: SYST:CONF:ICH? Example response: 10

#### **6.5.8.5 SYSTem:CONFigure:IDEVice?**

This query command returns the number of installed input devices.

Example command: SYST:CONF:IDEV?

Example response: 2

#### **6.5.8.6 SYSTem:CONFigure:INPut[n]:DADdress?**

This query command returns the device address (number of the device within its module) of a given input device. The input device number is given by the INP suffix n. Input devices are assigned numbers sequentially starting with 1. The command SYST:CONF:IDEV? (Section 6.5.8.5) can be used to determine the number of installed input devices.

Example command: SYST:CONF:INP2:DADD?

Example response: 1



#### 6.5.8.7 *SYSTem:CONFigure:INPut[n]:MADdress?*

This query command returns the number of the module that contains a given input device. The input device number is given by the INP suffix n. Input devices are assigned numbers sequentially starting with 1. The command SYST:CONF:IDEV? (Section 6.5.8.5) can be used to determine the number of installed input devices.

Example command: SYST:CONF:INP2:MADD?

Example response: 2

#### 6.5.8.8 *SYSTem:CONFigure:MNUMber?*

This query command returns the number of installed modules.

Example command: SYST:CONF:MNUM?

Example response: 3

#### 6.5.8.9 *SYSTem:CONFigure:MODule[n]:DEVice[n]:INFormation?*

This query command returns information about a given device. The device is specified by module number and device number. The module and device numbers are given by the MOD suffix and DEV suffix respectively. The command SYST:CONF:MNUM? (Section 6.5.8.8) can be used to query the number of installed modules and the command SYST:CONF:MOD[n]:DNUM? (Section 6.5.8.10) can be used to determine the number of devices within a module.

The format of the response is as follows:

**< name >, < class >, < channels >**

The < name > parameter is a string, enclosed in quotes, showing the name of the device. The < class > parameter is a character mnemonic (without quotes) showing the class of the module. This is either INP for input, OUTF for data output, PRIN for printer output, or COMM for communication. The < channels > parameter is a numeric value showing the number of channels in the device.

Example command: SYST:CONF:MOD1:DEV1:INF?

Example response: "SPRT",INP,2

#### 6.5.8.10 *SYSTem:CONFigure:MODule[n]:DNUMber?*

This query command returns the number of devices in a given module. The module number is given by the MOD suffix n. The command SYST:CONF:MNUM? (Section 6.5.8.8) can be used to determine the number of installed modules.

Example command: SYST:CONF:MOD3:DNUM?

Example response: 5

#### 6.5.8.11 *SYSTem:CONFigure:MODule[n]:INFormation?*

This query command returns information about a given module. The module number is given by the MOD suffix n. The command SYST:CONF:MNUM? (Section 6.5.8.8) can be used to determine the number of installed modules.

The format of the response is as follows:

**< name >, < devices >, < model number >,  
< serial\_number >, < firmware version >**

The < name > parameter is a string, enclosed in quotes, showing the name of the module. The < devices > parameter is a numeric value showing the number of devices in the module. The < model number > parameter is a character value (without quotes) showing the model number of the module. The < serial number > parameter is a character value (without quotes) showing the serial number of the module. If the serial number is not available 0 is returned. The < firmware version > is a numeric value of the form v.vv showing the firmware version number for the module.

Example command: SYST:CONF:MOD1:INF?

Example response: "SPRT",1,2560,A26123,1.12

#### 6.5.8.12 *SYSTem:CONFigure:OCHannel?*

This query command returns the total number of installed output channels.

Example command: SYST:CONF:OCH?

Example response: 1

#### 6.5.8.13 *SYSTem:CONFigure:ODEVice?*

This query command returns the number of installed output devices.

Example command: SYST:CONF:ODEV?

Example response: 1

#### 6.5.8.14 *SYSTem:CONFigure:OUTPut[n]:DADdress?*

This query command returns the device address (number of the device within its module) of a given output device. The output device number is given by the OUTP suffix n. Output devices are assigned numbers sequentially starting with 1. The command SYST:CONF:ODEV? (Section 6.5.8.13) can be used to determine the number of installed output devices.

Example command: SYST:CONF:OUTP1:DADD?

Example response: 5

#### 6.5.8.15 *SYSTem:CONFigure:OUTPut[n]:MADdress?*

This query command returns the module number or address of the module that contains a given output device. The output device number is given by the OUTP suffix n. Output devices are assigned numbers sequentially starting with 1. The command SYST:CONF:ODEV? (Section 6.5.8.13) can be used to determine the number of installed output devices.

Example command: SYST:CONF:OUTP1:MADD?

Example response: 3

**6.5.8.16**     *SYSTem:CONFigure:PDEvice?*

This query command returns the number of installed printer devices.

Example command: SYST:CONF:PDEV?

Example response: 1

**6.5.8.17**     *SYSTem:CONFigure:PRINter[n]:DADDRESS?*

This query command returns the device address (number of the device within its module) of a given printer device. The printer device number is given by the PRIN suffix n. Printer devices are assigned numbers sequentially starting with 1. The command SYST:CONF:PDEV? (Section 6.5.8.16) can be used to determine the number of installed printer devices.

Example command: SYST:CONF:PRIN1:DADD?

Example response: 4

**6.5.8.18**     *SYSTem:CONFigure: PRINter[n]:MADDRESS?*

This query command returns the module number or address of the module that contains a given printer device. The printer device number is given by the PRIN suffix n. Printer devices are assigned numbers sequentially starting with 1. The command SYST:CONF:PDEV? (Section 6.5.8.16) can be used to determine the number of installed printer devices.

Example command: SYST:CONF:PRIN1:MADD?

Example response: 3

**6.5.8.19**     *SYSTem:MODule[n]:DEVice[n]:READ? < device\_command >*

This query command is used to read configuration parameters directly from a device. The device is specified by module number and device number. The module and device numbers are given by the MOD suffix and DEV suffix respectively. The command SYST:CONF:MNUM? (Section 6.5.8.8) can be used to determine the number of installed modules and the command SYST:CONF:MOD[n]:DNUM? (Section 6.5.8.10) can be used to determine the number of devices within a module. The < device\_command > parameter is the command string (enclosed in quotes) passed to the device. Each device has a unique set of commands (refer to the operating instructions for a specific module for a list of its device commands). The response type can be either a numeric value or character data depending on the device command.

Example command: SYST:MOD2:DEV1:READ? "CURR"

Example response:10

### 6.5.8.20 *SYSTem:MODUle[n]:DEVice[n]:WRITe < device\_command >, < value >*

This command can be used to directly send a command to a device to set a configuration parameter. The device is specified by module number and device number. The module and device numbers are given by the MOD suffix and DEV suffix respectively. The command SYST:CONF:MNUM? (Section 6.5.8.8) can be used to determine the number of installed modules and the command SYST:CONF:MOD[n]:DNUM? (Section 6.5.8.10) can be used to determine the number of devices within a module. The < device\_command > is the command string (enclosed in quotes) passed to the device. Each device has a unique set of commands (refer to the operating instructions for a specific module for a list of its device commands). The < value > parameter, numeric or character data depending on the command, may be used to set a parameter. The \*RST command does not affect any device configuration parameters.

Example command: SYST:MOD2:DEV1:WRITE "CURR",10

### 6.5.9 *System Commands*

This group of commands deals with the general system configuration. The commands are summarized in Table 21.

**Table 18. System Commands**

Command	Action
*IDN?	Query instrument identification
*OPT?	Return model numbers of installed modules
*RST	System reset
SYSTem:DATE < year >, < month >, < day >	Set the date
SYSTem:DATE?	Query the date
SYSTem:SNUMber < serial_number >	Set the system serial number
SYSTem:SNUMber?	Query the system serial number
SYSTem:TIME < hour >, < minute >, < second >	Set the time
SYSTem:TIME?	Query the time
SYSTem:VERSion?	Query SCPI implementation version number
UNIT:TEMPerature < unit >	Set the temperature unit
UNIT:TEMPerature?	Query the current temperature unit setting

### 6.5.9.1 \*IDN?

This query command returns the instrument identification string that indicates the manufacturer, model number, serial number, and firmware version. The serial number can be set with the SYST:SNUM command (Section 6.5.9.6). If the serial number is not available 0 is returned. The format of the response is as follows:

**HART,1560, < serial\_number >, < v.vv >**

Example command: \*IDN?

Example response: HART,1560,641022,1.11

### 6.5.9.2 \*OPT?

This query command returns a list of installed modules. Modules are reported by position, front to back for the eight positions. The module model number is reported if a module is installed or 0 is returned otherwise. Numbers are separated by commas. For example, if the 1560 is equipped with one 2560 SPRT module in front and two 2566 Thermocouple Scanner modules, the following example would have the given response.

Example command: \*OPT?

Example response: 2560,2566,2566,0,0,0,0,0

### 6.5.9.3 \*RST

This command sets the instrument operating parameters to defined conditions. It is equivalent to using the SYSTEM RESET function in the SYSTEM soft-key menu. It has the following effects:

- Sets the measure mode to off.
- Sets the COUNT N number to 1.
- Sets the measurement delay to 0.
- Sets the primary channel to input channel 1.
- Sets the scan channel list to include all channels.
- Sets the scan mode to primary channel.
- Sets input average to off.
- Disables routing to all output channels by setting the positive input channel number to 0, the negative input channel number to 0, and the calculation type to temperature.
- Sets printing to all printer interface devices to off.
- Clears the statistical functions.
- Sets units to C.

This command does not affect probe parameters and characterization coefficients, display setup, time, password options, module device setup or calibration parameters, or communications status registers.

Example command: \*RST

#### 6.5.9.4 *SYSTem:DATE* < year >, < month >, < day >

This command sets the date. It is equivalent to setting the date using the TIME function in the SYSTEM soft-key menu. The < year > parameter is a four-digit number. The < month > parameter is a one or two-digit number from 1 to 12. The < day > parameter is a one or two-digit number from 1 to 31.

Example command: SYST:DATE 1996,5,23

#### 6.5.9.5 *SYSTem:DATE?*

This query command returns the date. The response is in the format < year >, < month >, < day >.

Example command: SYST:DATE?

Example response: 1996,5,23

#### 6.5.9.6 *SYSTem:SNUMber* < serial\_number >

This command sets the instrument's serial number. This serial number appears in the serial number field of the identification queried with the \*IDN? command (Section 6.5.9.1). The serial number may include any digits and letters from one to ten characters. The default serial number is 0. The \*RST command has no effect on the serial number.

Example command: SYST:SNUM 641022

#### 6.5.9.7 *SYSTem:SNUMber?*

This query command returns the instrument serial number. If no serial number has been set 0 is returned.

Example command: SYST:SNUM?

Example response: 641022

#### 6.5.9.8 *SYSTem:TIME* < hour >, < minute >, < second >

This command sets the time. It is equivalent to setting the time using the TIME function in the SYSTEM soft-key menu. The < hour > parameter is a one or two-digit number, from 0 to 23, for the hour in 24-hour mode, e.g. 23 for 11:00 p.m. The < minute > parameter is a one or two-digit number, from 0 to 59, for the minute. The < second > parameter is a one or two-digit number, from 0 to 60, for the second.

Example command: SYST:TIME 11,43,23

#### 6.5.9.9 *SYSTem:TIME?*

This query command returns the time. The response is in the format < hour >, < minute >, < second >.

Example command: SYST:TIME?

Example response: 11,43,23

**6.5.9.10**     *SYSTem:VERSion?*

This command returns the SCPI version number.

Example command: SYST:VERS?

Example response: 1994.0

**6.5.9.11**     *UNIT:TEMPerature <unit>*

This command sets the system temperature units. It is equivalent to setting the units using the UNITS function in the SYSTEM soft-key menu. The < unit > parameter is either C or CEL for Celsius, F or FAR for Fahrenheit, or K for Kelvin. The \*RST command sets the units to Celsius.

Example command: UNIT:TEMP C

**6.5.9.12**     *UNIT:TEMPerature?*

This query command returns the system temperature unit. The response is either CEL for Celsius, FAR for Fahrenheit, or K for Kelvin.

Example command: UNIT:TEMP?

Example response: CEL

**6.5.10 Status Commands**

This group includes commands to report the status and conditions of the instrument. The commands are summarized in Table 22. None of the status registers and queues are directly affected by the \*RST command.

**6.5.10.1**     *\*CLS*

This command clears the status registers. It clears the Event Status Register, Operation Status Event Register, Questionable Status Event Register, and system error queue. The Status Byte Register is updated to show that the Event Status Register, Operation Status Condition Register, and Questionable Status Condition Register are cleared. This command does not affect the Operation Status Condition Register, Questionable Status Condition Register, Event Status Enable Register, Operation Status Enable Register, Questionable Status Enable Register, or the output (response) queue.

**6.5.10.2**     *\*ESE < numeric\_value >*

This command sets the Event Status Enable Register. This register determines which event bits of the Event Status Register affect the ESB Event Summary-Message Bit of the Status Byte Register. If any event bit of the Event Status Register is set (1) while its corresponding mask bit of the Event Status Enable Register is set, the ESB Event Summary-Message Bit of the Status Byte Register will be set. The value of the < numeric\_value > parameter is a number from 0 to 255 that is the sum of the binary-weighted values of each mask bit. The Event Status Register is described in Section 6.5.10.4 below. The following example causes the ESB bit in the Status Byte Register to be set whenever a command error or execution error occurs.

Example command: \*ESE 48

### 6.5.10.3 \*ESE?

This query command returns the Event Status Enable Register (see 6.5.10.2 above).

Example command: \*ESE?

Example response: 48

### 6.5.10.4 \*ESR?

This query command returns the Event Status Register. It also clears the Event Status Register and the ESB bit of the Status Byte Register. The value returned indicates the condition of each of the eight bits of the register by adding the binary-weighted values of each bit. The meaning of each bit, when set (1), is as follows where 0 is the least significant and 7 is the most significant:

- 0 Operation complete (OPC). Execution of the last command is completed.
- 1 Request control (RQC). No function for this instrument.
- 2 Query error (QYE). An attempt has been made to read data when none is available or pending.
- 3 Device dependent error (DDE). A hardware error condition occurred.
- 4 Execution error (EXE). An invalid parameter for a command has been received or the command could not be executed under existing conditions.
- 5 Command error (CME). An unrecognized command or a command with improper syntax has been received.
- 6 User request (URQ). No function for this instrument.
- 7 Power on (PON). Always set after the power is switched on.

The ESB bit of the Status Byte Register (Section 6.5.10.9) is set (1) whenever any bit of the Event Status Register is set and its corresponding mask bit in the Event Status Enable Register (Section 6.5.10.3) is set. The Event Status Register is cleared when queried with the ESR? Command or when the \*CLS command is received. The response in the following example would be given after an invalid command is received by the 1560 and no other error occurred.

Example command: \*ESR?

Example response: 32



**6.5.10.5 \*OPC**

This command causes the Operation Complete (OPC) event bit in the Event Status Register to be set as soon as all pending command operations are completed. Since all commands are sequential for this instrument this command is unnecessary.

**Table 19. Status Commands**

Command	Action
*CLS	Clear status
*ESE < numeric_value >	Set Standard Event Status Enable Register
*ESE?	Query Standard Event Status Enable Register
*ESR?	Query Standard Event Status Register
*OPC	Enable Operation Complete message
*OPC?	Query Operation Complete flag
*SRE < numeric_value >	Set Service Request Enable Register
*SRE?	Query Service Request Enable Register
*STB?	Query Status Byte
*TST?	Perform self-test and return status
*WAI	Wait to continue
STATus:OPERation:CONDition?	Query Operation Status Condition Register
STATus:OPERation:ENABLE < numeric_value >	Set Operation Status Event Enable Register
STATus:OPERation:ENABLE?	Query Operation Status Event Enable Register
STATus:OPERation[:EVENT]?	Query Operation Status Event Register
STATus:PRESet	Set status registers to defaults
STATus:QUEStionable:CONDition?	Query Questionable Status Condition Register
STATus:QUEStionable:ENABLE < numeric_value >	Set Questionable Status Event Enable Register
STATus:QUEStionable:ENABLE?	Query Questionable Status Event Enable Register
STATus:QUEStionable[:EVENT]?	Query Questionable Status Event Register
STATus:QUEue[:NEXT]?	Query system error message
SYSTem:ERRor?	Query system error message

**6.5.10.6 \*OPC?**

This query command returns “1” as soon as all other pending command operations are completed. Since all commands are sequential for this instrument this command is unnecessary.

#### 6.5.10.7 \*SRE < numeric\_value >

This command sets the Service Request Enable Register. This register determines which event bits of the Status Byte Register affect the MSS Master Summary Status message bit of the Status Byte Register and generate a service request with the IEEE-488 interface. If any event bit of the Status Byte Register is set (1) while its corresponding mask bit of the Service Request Enable Register is set, the MSS Master Summary Status message bit of the Status Byte Register will be set and a service request generated. The value of the < numeric\_value > parameter is a number from 0 to 255 that is the sum of the binary-weighted values of each mask bit. The Status Byte Register is described in section 5.5.10.9 below. The following example causes the MSS bit in the Status Byte Register to be set and a service request to be generated whenever the ESB bit of the Status Byte Register is set.

Example command: \*SRE 32

#### 6.5.10.8 \*SRE?

This query command returns the Service Request Enable Register (see Section 6.5.10.7 above).

Example command: \*SRE?

Example response: 32

#### 6.5.10.9 \*STB?

This query command returns the Status Byte Register. Reading this register does not affect it or the output queue. The value returned indicates the condition of each of the eight bits of the register by adding the binary-weighted values of each bit. The meaning of each bit, when set (1), is as follows where 0 is the least significant and 7 is the most significant:

- 0 No function, always 0.
- 1 No function, always 0.
- 2 Error Bit (ERR). Indicates that an error message is in the error queue.
- 3 Questionable Status Bit (QSB). Indicates that a bit in the Questionable Status Event Register is set and its corresponding mask bit in the Questionable Status Enable Register is set. It is cleared when the Questionable Status Event Register is cleared (by reading it, Section 6.5.10.20).
- 4 Message Available (MAV). Indicates that data is present in the output queue. (Applicable only for IEEE-488 service request and serial poll.)
- 5 Event Status Bit (ESB). Indicates that a bit in the Event Status Register is set and its corresponding mask bit in the Event Status Enable Register is set. It is cleared when the Event Status Register is cleared (by reading it, Section 6.5.10.4).

- 6 Master Summary Status (MSS). Indicates that any other bit in the Status Byte Register is set and its corresponding mask bit in the Service Request Enable Register is set (see Section 6.5.10.7).
- 7 Operation Status Bit. Indicates that a bit in the Operation Status Event Register is set and its corresponding mask bit in the Operation Status Enable Register is set. It is cleared when the Operation Status Event Register is cleared (by reading it, Section 6.5.10.15).

The Status Byte Register can also be read from the IEEE-488 interface using serial poll (see Section 14.4.5). The Status Byte Register cannot be set or cleared directly but always reflects the current state of the reported conditions. The response in the following example would be given after an invalid command is received by the 1560 if the CME mask bit is set in the Event Status Enable Register and the ESB mask bit is set in the Service Request Enable Register and no other error occurred.

Example command: \*STB?

Example response: 100

#### 6.5.10.10 \*TST?

The purpose of this query command is to perform a self-test and report any errors that are found. The response is 0 if no errors are found. Currently, self-test can only be performed on power up so this command always returns 0.

#### 6.5.10.11 \*WAI

The purpose of this command is to cause a device to wait until all pending command operations (overlapped commands) are completed before executing any subsequent commands. Since all commands are sequential for this instrument this command is unnecessary.

#### 6.5.10.12 STATus:OPERation:CONDition?

This query command reads the Operation Status Condition Register. Reading this register does not affect it. The value returned indicates the condition of each of the eight bits of the register by adding the binary-weighted values of each bit. The meaning of each bit, when set (1), is as follows where 0 is the least significant and 7 is the most significant:

0-3 No function, always 0.

4 Measuring. Acquisition of a new measurement is in process.

5-15 No function, always 0.

The response in the following example would be given if the measure mode is ON or COUNT.

Example command: STAT:OPER:COND?

Example response: 16

**6.5.10.13**     **STATus:OPERation:ENABle < numeric\_value >**

This command sets the Operation Status Enable Register. This register determines which event bits of the Operation Status Event Register affect the Operation Status Bit (OSB, bit 7) of the Status Byte Register. If any bit in the Operation Status Event Register is set (1) while its corresponding mask bit in the Operation Status Enable Register is set, the Operation Status Bit in the Status Byte Register will be set. The value of the < numeric\_value > parameter is a number from 0 to 65535 that is the sum of the binary-weighted values of each mask bit. The Operation Status Event Register is described in Section 6.5.10.15. The following example causes the OSB bit in the Status Byte Register to be set when a new measurement has been acquired.

Example command: STAT:OPER:ENAB 16

**6.5.10.14**     **STATus:OPERation:ENABle?**

This query command returns the Operation Status Enable Register (see 6.5.10.13 above).

Example command: STAT:OPER:ENAB?

Example response: 16

**6.5.10.15**     **STATus:OPERation[:EVENT]?**

This query command reads the Operation Status Event Register. Bits in this register are set whenever the corresponding bit in the Operation Status Condition Register are set. The bit remains set even if the corresponding bit in the Operation Status Condition Register returns FALSE. The Operation Status Event Register is cleared when it is read. It can also be cleared with the \*CLS command (see Section 6.5.10.1).

0-3     No function, always 0.

4       Measurement complete. Acquisition of a new measurement is complete.

5-15    No function, always 0.

The response in the following example would be given if a new measurement was acquired since the last time this command was issued.

Example command: STAT:OPER?

Example response: 16

**6.5.10.16**     **STATus:PRESet**

This command sets both the Operation Status Enable Register and Questionable Status Enable Register to 0 (see Sections 6.5.10.13 and 6.5.10.18).

**6.5.10.17**     *STATus:QUEStionable:CONDition?*

This query command reads the Questionable Status Condition Register. Reading this register does not affect it. The value returned indicates the condition of each of the eight bits of the register by adding the binary-weighted values of each bit. The meaning of each bit, when set (1), is as follows where 0 is the least significant and 7 is the most significant:

- 0-3     No function, always 0.
- 4       Temperature. The last temperature measurement is out-of-range or otherwise questionable. This is reset when a new valid measurement is acquired.
- 5-15    No function, always 0.

**6.5.10.18**     *STATus:QUEStionable:ENABle < numeric\_value >*

This command sets the Questionable Status Enable Register. This register determines which event bits of the Questionable Status Event Register affect the Questionable Status Bit (QSB, bit 3) of the Status Byte Register. If any bit of the Questionable Status Event Register is set (1) while its corresponding mask bit of the Questionable Status Enable Register is set, the QSB bit in the Status Byte Register will be set. The value of the < numeric\_value > parameter is a number from 0 to 65535 that is the sum of the binary-weighted values of each mask bit. The Questionable Status Event Register is described in Section 6.5.10.20.

**6.5.10.19**     *STATus:QUEStionable:ENABle?*

This query command returns the Questionable Status Enable Register (see 6.5.10.18 above).

**6.5.10.20**     *STATus:QUEStionable[:EVENT]?*

This query command reads the Questionable Status Event Register. Reading this register clears it. The value returned indicates the condition of each of the eight bits of the register by adding the binary-weighted values of each bit. The meaning of each bit, when set (1), is as follows where 0 is the least significant and 7 is the most significant:

- 0-3     No function, always 0.
- 4       Temperature. A previous temperature measurement was out-of-range or otherwise questionable.
- 5-15    No function, always 0.

**6.5.10.21**     *STATus:QUEue[:NEXT]?*

This query command functions identically to the SYST:ERR? command (see below).

#### 6.5.10.22 *SYSTem:ERRor?*

This query command returns a system error message if any are present in the system error queue. Each error condition produces only one error message at a time. The error queue may contain up to two messages. Messages are reported in the order they occur. Reading a message from the queue removes the message so the next message can be read. If more than two errors occur before being read the second error in the queue will be "Queue overflow" and all but the first error will be discarded. Any error will also cause the Error Bit (ERR, bit 2) of the Status Byte Register (Section 6.5.10.9) to be set. This command returns error messages in the following format:

**< error\_number >," < error\_description >"**

The < error\_number > is a value between -32768 and 32767. If the error message queue contains no error messages the following message is reported:

**0, "No error"**

Following is a list of error messages that may be reported:

- 0 "No error". This message is reported when no error message is held in the error queue.
- 100 "Command error". An invalid command was received. This may be caused by any of the following conditions:
  - The command was misspelled.
  - The header separator was incorrect.
  - The command is not acceptable with this instrument or firmware version.
  - A query command was missing the question mark.
  - A required parameter was missing.
- 200 "Execution error". A valid command was received but was unable to be executed.
- 213 "Init ignored". An INIT:IMM command was received while a measurement was already in process.
- 221 "Settings conflict". A command could not be executed because of the current configuration or condition of the instrument, possibly because of incompatible probe type.
- 222 "Data out of range". A received parameter value was outside the valid range or the received data type was incorrect.
- 294 "Incompatible type". The CALCn:CONV: COPY command was received but was unable to execute because the source channel and destination channel were of incompatible types.
- 300 "Device-specific error". A hardware error occurred.

- 315“Configuration memory lost”. The start-up self-test detected that the data in non-volatile RAM was invalid or was cleared because the hardware configuration had changed.
- 330“Self-test failed”. The start-up self-test detected a hardware problem such as a module bus error.
- 350“Queue overflow”. This message is placed at the end of the buffer (in place of the last message) when an error occurred while the error queue was full.
- 360“Communication error”. Transmission of a response was unsuccessful due to output buffer overflow.
- 400“Query error”. The remote device attempted to receive data from the 1560 but no data was present or pending in the output buffer.

Errors numbered -100 to -199 also generate a command error (CME) in the Event Status Register (see Section 6.5.10.4). Errors numbered -200 to -299 also generate an execution error (EXE) in the Event Status Register. Errors numbered -300 to -399 also generate a device-dependent error (DDE) in the Event Status Register. Errors numbered -400 to -499 also generate a query error (QYE) in the Event Status Register (see Section 6.5.10.4).

## 6.6 Programming Example

Figure 12 is a listing of a sample BASIC program that can be used to operate the 1560 remotely with a computer. This program runs with QBASIC or GWBASIC on a PC-compatible computer. The program uses the COM2 RS-232 port of the computer. For wiring of the interface cable refer to Figure 11 in Section 6.2. The program requires the BAUD rate of the 1560 to be set to 2400, the DUPLEX to be HALF, and the LINEFEED to be OFF. These parameters are set using the **SET UP DEVICE** function in the **MODULE** soft-key menu (see Section 5.4.2). Select the SER device. A window appears showing the setup parameters for the serial port. Set the parameters as shown.

The program first resets all operating parameters of the 1560 to default settings. Then it programs the 1560 to measure channel 1 continuously. It will periodically check the operational status register and when it finds that a new measurement is available it will read the measurement and print it on the computer screen. To exit the program press any key on the computer keyboard.

```
SET UP DEVICE: SER
BAUDRATE: 2400
DUPLEX: HALF
LINEFEED: OFF
```

```
1 This example continualV reads temperature from the Hart 1560.
2 Connect the 1560 serial port to the COM2 port of the computer.
3 Set the BAUD rate of the 1560 to 2400.
4 Set DUPLEX to HALF.
5 Set LINEFEED to OFF.
6
8 open COM2 port, 2400 baud, no parity, 8 data bits, 1 stop bit
9 disable handshaking
10 OPEN "COM2:2400,N,8,1,CD0,DS0,CS0" FOR RANDOM AS #1
19 reset all operating parameters to defaults
20 PRINT #1, "**RST"
29 select channel 1
30 PRINT #1, "ROUT:CLOS (@1)"
39 set to measure continuousV
40 PRINT #1, "INIT:CONT ON"
49 clear status registers
50 PRINT #1, "**CLS"
100 main loop
110 K$=INKEY$: IF K$<>" " GOTO 500 'quit if arV keV pressed
120 GOSUB 1000 'read a new measurement
130 PRINT A$ 'print to the screen
140 GOTO 100
500 end program
510 CLOSE
520 END
1000 SUB: read one new measurement
1010 wait for new measurement complete
1020 CNT2 = 0 'measurement timeout counter
1030 PRINT #1, "STAT:OPER?" 'request status
1040 GOSUB 1200 'read status
1050 IF VAL(A$) AND 16 THEN 1100 'measurement complete
1060 GOSUB 1300 'wait .1 sec.
1070 CNT2 = CNT2+1
1080 IF CNT2>20 THEN 1150 ELSE 1030 'timeout after 2 sec.
1100 read new measurement
1110 PRINT #1, "FETC?" 'request measurement
1120 GOSUB 1200 'read measurement
1130 RETURN
1150 PRINT "Error: Not measuring"
1160 CLOSE: END
1200 SUB: read response
1210 CNT1 = 0 'response timeout counter
1220 IF NOT EOF(1) GOTO 1260 'response sent
1230 GOSUB 1300 'wait another .1 sec
1240 CNT1 = CNT1+1
1250 IF CNT1>20 THEN 1280 ELSE 1220 'timeout after 2 sec.
1260 LINE INPUT #1, A$ 'read response
1270 RETURN
1280 PRINT "Error: No response" 'timeout
1290 CLOSE: END
1300 SUB: wait for .1 second
1310 T=TIMER
1320 IF TIMER<T+.1 THEN 1320
1330 RETURN
```

Figure 12. Programming Example



# Chapter 7

## 2560/2567 SPRT Module

This section explains the features and operation of the optional 2560/2567 SPRT Module.

### 7.1 Description

The 2560/2567 SPRT Module is an add-on module that allows the 1560 to measure temperature with SPRT, PRT, and RTD sensors. These modules are capable of measuring temperature with very high accuracy. The Model 2560 accepts two or four-wire sensors with nominal resistance of 25  $\Omega$  or 100  $\Omega$ , while the 2567 accepts two or four-wire sensors with nominal resistance of 500  $\Omega$  or 1000  $\Omega$ . The modules use 1 mA excitation current to minimize sensor self-heating. The excitation current alternates polarity to minimize the effects of thermoelectric offsets. Two sensors can be connected to the 2560/2567 simultaneously and measured alternately.

### 7.2 Specifications

	2560	2567
Resistance range	0 to 400 $\Omega$	0 to 4 K $\Omega$
Resistance accuracy, one-year <sup>1</sup>	0 to 25 $\Omega$ : 0.0005 $\Omega$ 25 to 400 $\Omega$ : 20 ppm of reading	0 to 250 $\Omega$ : 0.00625 $\Omega$ 250 to 4K $\Omega$ : 25 ppm of reading
Resistance accuracy, short-term <sup>1,2</sup>	0 to 25 $\Omega$ : 0.00025 $\Omega$ 25 to 400 $\Omega$ : 10 ppm of reading	0 to 250 $\Omega$ : 0.00375 $\Omega$ 250 to 4K $\Omega$ : 15 ppm of reading
Temperature accuracy (typical, not including sensor uncertainty) <sup>1</sup>		
-100 °C	$\pm 0.003$ °C	$\pm 0.004$ °C
0 °C	$\pm 0.005$ °C	$\pm 0.006$ °C
100 °C	$\pm 0.007$ °C	$\pm 0.009$ °C
200 °C	$\pm 0.010$ °C	$\pm 0.012$ °C
300 °C	$\pm 0.012$ °C	$\pm 0.015$ °C
400 °C	$\pm 0.014$ °C	$\pm 0.018$ °C
500 °C	$\pm 0.017$ °C	$\pm 0.021$ °C
600 °C	$\pm 0.020$ °C	$\pm 0.025$ °C

Temperature coefficient <sup>1</sup>	0.5 ppm/ °C	2.5 ppm/ °C
Excitation current	1.0, 1.4mA; 1 Hz	
Maximum lead resistance	100 Ω	
Sample time	2 seconds	
Number of channels	2	
Recommended operating temperature range <sup>1</sup>	18 to 28 °C (64 to 82 °F)	
Absolute operating temperature range	5 to 35 °C (40 to 95 °F)	
Weight	2 lbs.	
<sup>1</sup> The accuracy specifications apply within the recommended operating temperature range. Accuracy limits are increased by a factor of the temperature coefficient outside this range. <sup>2</sup> Short-term accuracy includes nonlinearity and noise uncertainties. It does not include drift or calibration uncertainties.		

## **7.3 Operation**

Using the 2560/2567 SPRT Module with the 1560 Black Stack is very simple. The following sections explain the steps for setting up and using the 2560/2567 to measure with SPRTs. For instructions for installing the 2560/2567 SPRT Module onto the 1560 see Section 4.1.

### **7.3.1 Connecting a Probe**

The 2560/2567 SPRT Module has ten patented DWF connectors (U.S. Patent number 5,964,625) posts; five each for the two channels (see Figure 13). The red terminals connect to one side of the sensor. One sources current and the other senses the voltage. The black terminals connect to the other side of the sensor. One sources current and the other senses the voltage. The green terminal connects to ground and can be used to ground a shield wire. Two probes can be connected to the 2560/2567 at once.

To connect two-wire probes to one channel, connect one wire to both red terminals and the other wire to both black terminals. If there is a shield or guard wire connect it to the green terminal.

To connect four-wire probes to one channel, connect the wires from one common pair (wires that are shorted together at the sensor element) to the red terminals and the wires from the other pair to the black terminals. If there is a shield or guard wire connect it to the green terminal.

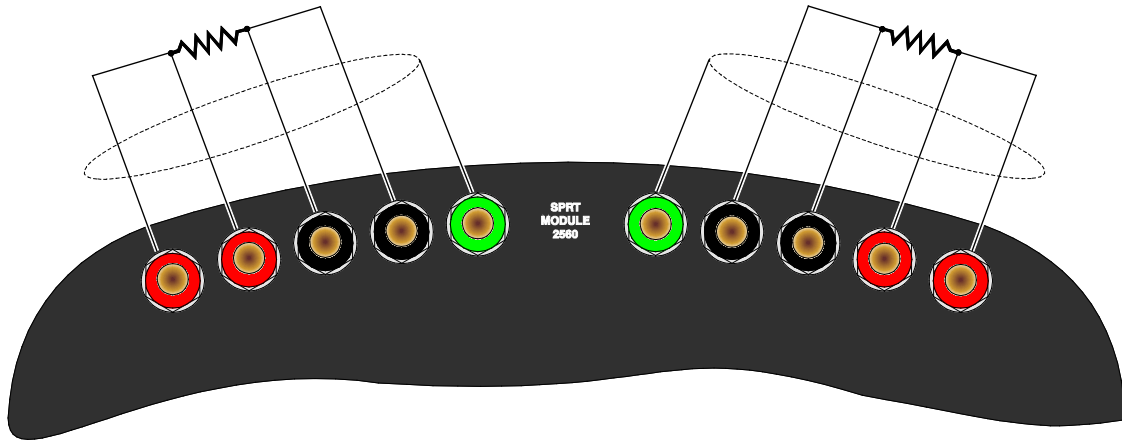

Figure 13. Sensor Wiring Diagram

### 7.3.2 Setting Coefficients

Once a PRT or SPRT probe is properly connected to the 2560/2567, the 1560 can read its resistance. To display temperature accurately, the 1560 must be programmed with the characterization coefficients for the sensor. This is done using the **EDIT PROBE** soft-key in the **PROBE** menu (see Section 5.2.1). The coefficient values are normally provided with the probe on a calibration report. Be sure to select the proper range for ITS-90 characterizations. If IEC-751 RTDs are used you may select the CVD conversion and use R0: 100, ALPHA: 0.00385, DELTA: 1.507, and BETA: 0.111.

### 7.3.3 Current

The 2560/2567 sources current to the sensor and measures the resulting voltage across the sensor to determine its resistance. The current alternates every 0.5 seconds to reduce the effects of thermoelectric offsets. The normal current is 1.0 mA (2560) or 0.1 mA (2567). The current can be changed to test self-heating effects using the **SET UP DEVICE** function in the **MODULE** menu (see Section 5.4.2). Change the **CURRENT** parameter and press **ENTER**.

The **SET UP DEVICE** function also allows access to two other parameters. **SAMP PER** selects the sample period between 2 (normal) and 10 seconds. **RES RANGE** sets the resistance range between **AUTO** ranging (normal), **LOW** range, and **HIGH** range. The purpose of these options is mainly for trouble-shooting and they should not be changed during normal operation.

### 7.3.4 Device Setup Commands

The SYST:MODn:DEVn:READ? and SYST:MODn:DEVn:WRIT commands (see Sections 6.5.8.19 and 6.5.8.20) can be used to read or set the setup parameters for the 2560/2567 SPRT Module. The device number of the SPRT Input Device is 1. The module number for the 2560/2567 module is its position in the stack. For example, if the 1560 has four add-on modules, the 2560/2567 being first, the module number for the 2560/2567 is 1. Table 23 shows the device commands used to read or set the setup parameters of the SPRT Input Device.

Table 20. SPRT Module Device Commands

Device Command	Parameter	Description
CURR	1, 1.4 (2560)	Excitation current, mA
SAMP	2, 10	Sample period, seconds
ARNG	AUTO, LOW, HIGH	Resistance range

Below are some examples of using the device commands to set the device setup parameters. For these examples it is assumed that the 2560/2567 SPRT Module is placed first in the stack. These commands can be sent through any communication interface including the IEEE-488 and RS-232 interfaces.

SYST: MOD1:DEV1:WRIT "CURR",1.4 *Set the excitation current to 1.4 mA.*

SYST:MOD1:DEV1:READ? "CURR" *Read the excitation current.*

## 7.4 Calibration

This section explains the calibration procedure for the 2560/2567 SPRT Module.

### 7.4.1 Calibration Parameters

The resistance measurement is derived from the ratio between the voltage measurements of the input resistor and reference resistor (100 Ω) using the following equation.



$$resistance = \frac{[8.3333 \cdot 10^{-4} (400\_ADJ)(ratio - 10) + 1.0]}{[(100.0 + 100\_ADJ)ratio + 0\_ADJ(1.0 - ratio)]}$$

Three adjustable calibration parameters are used for calibration:



0\_ADJ, 100\_ADJ, and 400\_ADJ. 0\_ADJ directly affects the measurement at 0 Ω. It has negligible effect at 100 Ω but significant affect at higher resistances.

100\_ADJ directly affects the measurement at 100 Ω. It has negligible effect at 0 Ω and proportionately greater effect the higher the resistance. 400\_ADJ directly affects the measurement at 400 Ω. It has negligible effect at 0 Ω and 100 Ω with greater effect the more the resistance deviates from 0 Ω or 100 Ω. Each of the parameters has a positive effect at their primary resistances: increasing the value of the parameter increases the measured resistance. The default and theoretically normal value for each is 0.

### 7.4.2 Front-panel Access

The calibration parameters 0\_ADJ, 100\_ADJ, and 400\_ADJ can be adjusted to optimize the accuracy. They can be accessed from the front panel of the 1560 using the **CAL DEVICE** soft-key function. This is found in the **MODULE** sub-menu. Pressing the **CAL DEVICE** soft-key shows a list of devices with the module position number. Use the   buttons to move the cursor to the SPRT module and press **ENTER**.

```
SELECT A DEVICE TO CALIBRATE
-----
>SPRT 1
  TCS  2
  PRTS 3
```

After the device is selected a new window appears showing the parameters and functions available from the device. New values can be entered for the parameters using the numeric buttons and pressing **ENTER**. The   buttons can be used to move between parameters.

For the 2560/2567 SPRT module the list of parameters includes 0\_ADJ, 100\_ADJ, and 400\_ADJ as described above. The list also includes the calibration date (CAL DATE) parameter, used to record the date the module was calibrated, and the (SER NUM) parameter, used to record the serial number of the module.

```
CALIBRATE DEVICE: SPRT
-----
0 ADJ: 0.0
100 ADJ: 0.0
400 ADJ: 0.0
CAL DATE: 05-21-96
SER NUM: A26123
```

### 7.4.3 Calibration Procedure (2560)

Calibration requires adjustment of the 0\_ADJ, 100\_ADJ, and 400\_ADJ parameters at three specific input resistances. If the resistances used are approximately 0  $\Omega$ , 100  $\Omega$  and 400  $\Omega$  respectively the adjustments are independent and the procedure is simple. The order in which the adjustments are performed is important. The adjustment of the 400\_ADJ parameter must be performed last as the adjustments of 0\_ADJ and 100\_ADJ affect the measurement at 400  $\Omega$  but 400\_ADJ does not affect the measurements at 0  $\Omega$  and 100  $\Omega$ . Either channel can be used for calibration. Set the conversion type to R(  $\Omega$ ) to display resistance (see Section 5.2.1.1 ). The accuracy required of the resistance standards is 1/4 of the instrument accuracy: that is  $\pm 0.00012$   $\Omega$  at 0  $\Omega$ ,  $\pm 0.0005$   $\Omega$  (5 ppm) at 100  $\Omega$ , and  $\pm 0.002$   $\Omega$  (5 ppm) at 400  $\Omega$ . The recommended procedure is as follows:

1. Connect a 0  $\Omega$  resistor to the input and measure its resistance. If a shorting wire is used, the wire should run from the inside black terminal to the inside red terminal to the outside red terminal then back across to the outside black terminal. Note the average error in the measurement. Adjust the 0\_ADJ parameter by subtracting the measured error. For example, if the input is exactly 0.0000  $\Omega$  and readout shows  $-0.0011$   $\Omega$ , 0\_ADJ should be adjusted by adding 0.0011 to it.
2. Connect a 100  $\Omega$  resistor (5 ppm accuracy) to the input and measure its resistance. Note the average error in the measurement. Adjust the 100\_ADJ parameter by subtracting the measured error. For example, if the input is exactly 100.0000  $\Omega$  and the readout shows 100.0295  $\Omega$ , 100\_ADJ should be adjusted by subtracting 0.0295 from it.
3. Connect a 400  $\Omega$  resistor (5 ppm accuracy) to the input and measure its resistance. Note the average error in the measurement. Adjust the 400\_ADJ parameter by subtracting the measured error. For example, if the input is exactly 400.0000  $\Omega$  and the readout shows 399.9913  $\Omega$ , 400\_ADJ should be adjusted by adding 0.0087 to it.
4. Record the date with the calibration date parameter.
5. Verify the accuracy at 0  $\Omega$ , 25  $\Omega$  or 50  $\Omega$ , 100  $\Omega$ , 200  $\Omega$ , and 400  $\Omega$ . Verify the accuracy of both channels with selected resistances. The accuracy must be within the short-term accuracy given in the specifications.

### 7.4.4 Calibration Procedure (2567)

The calibration procedure for the 2567 module is the same as the 2560 except the parameters 0\_ADJ, 1K\_ADJ, and 4K\_ADJ are used to calibrate the measurement at 0  $\Omega$ , 1K  $\Omega$ , and 4K  $\Omega$  respectively.

# Chapter 8

## 2561 HTPRT Module

This section explains the features and operation of the optional 2561 HTPRT Module.

### 8.1 Description

The 2561 HTPRT Module is an add-on module that allows the 1560 to measure temperature with high-temperature PRT sensors. It is capable of measuring high-temperature with very high accuracy. It accepts four-wire sensors with nominal resistances of 0.25  $\Omega$  to 5  $\Omega$ . It uses 3 or 5 mA excitation current to minimize sensor self-heating. The excitation current alternates polarity to minimize the effects of thermoelectric offsets. Two sensors can be connected to the 2561 simultaneously and measured alternately.

### 8.2 Specifications

Resistance range	0 to 25 $\Omega$
Resistance accuracy, one-year <sup>1</sup> 0 to 2 $\Omega$ 2 to 25 $\Omega$	0.0001 $\Omega$ 50 ppm of reading
Resistance accuracy, short-term <sup>1,2</sup> 0 to 2 $\Omega$ 2 to 25 $\Omega$	0.00008 $\Omega$ 40 ppm of reading
Temperature accuracy (typical, not including sensor uncertainty) <sup>1</sup> 0 $^{\circ}\text{C}$ 100 $^{\circ}\text{C}$ 400 $^{\circ}\text{C}$ 800 $^{\circ}\text{C}$ 1200 $^{\circ}\text{C}$	$\pm 0.013$ $^{\circ}\text{C}$ $\pm 0.018$ $^{\circ}\text{C}$ $\pm 0.035$ $^{\circ}\text{C}$ $\pm 0.060$ $^{\circ}\text{C}$ $\pm 0.090$ $^{\circ}\text{C}$

<b>Temperature coefficient<sup>1</sup></b>	2.5 ppm/ °C
<b>Excitation current</b>	3, 5mA; 1 Hz
<b>Maximum lead resistance</b>	10 Ω
<b>Sample time</b>	2 seconds
<b>Number of channels</b>	2
<b>Recommended operating temperature range<sup>1</sup></b>	18 to 28 °C (64 to 82 °F)
<b>Absolute operating temperature range</b>	5 to 35 °C (40 to 95 °F)
<b>Weight</b>	2 lbs.
<sup>1</sup> The accuracy specifications apply within the recommended operating temperature range. Accuracy limits are increased by a factor of the temperature coefficient outside this range. <sup>2</sup> Short-term accuracy includes nonlinearity and noise uncertainties. It does not include drift or calibration uncertainties.	

## 8.3 Operation

Using the 2561 HTPRT Module with the 1560 Black Stack is very simple. The following sections explain the steps for setting up and using the 2561 to measure with HTPRTs. For instructions for installing the 2561 HTPRT Module onto the 1560 see Section 4.1.

### 8.3.1 Connecting a Probe

The 2561 HTPRT Module has ten terminal posts, five each for the two channels (see Figure 14). The red terminals connect to one side of the sensor. One sources current and the other senses the voltage. The black terminals connect to the other side of the sensor. One sources current and the other senses the voltage. The green terminal connects to ground and can be used to ground a shield wire. Two probes can be connected to the 2561 at once.

To connect two-wire probes to one channel, connect one wire to both red terminals and the other wire to both black terminals. If there is a shield or guard wire connect it to the green terminal.

To connect four-wire probes to one channel, connect the wires from one common pair (wires that are shorted together at the sensor element) to the red terminals and the wires from the other pair to the black terminals. If there is a shield or guard wire connect it to the green terminal.



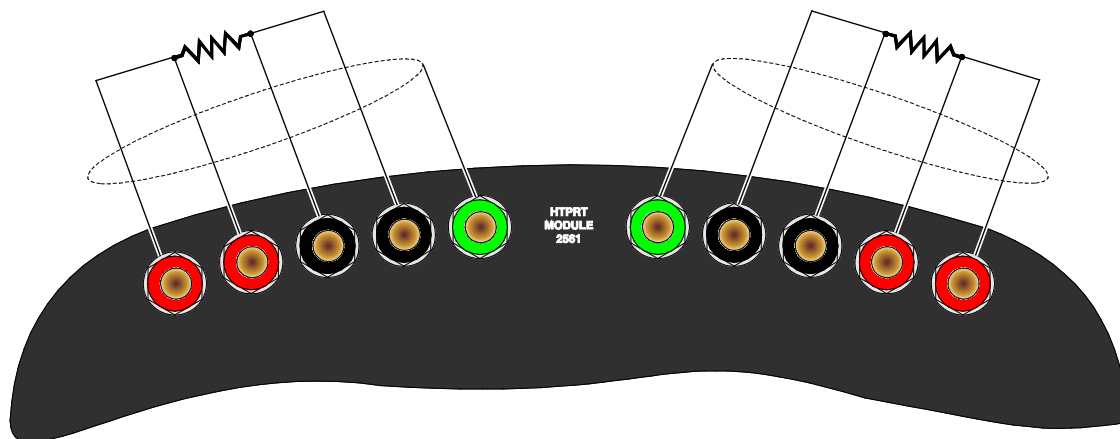

Figure 14 Sensor Wiring Diagram

### 8.3.2 Setting Coefficients

Once an HTPRT probe is properly connected to the 2561, the 1560 can read its resistance. To display temperature accurately, the 1560 must be programmed with the characterization coefficients for the sensor. This is done using the EDIT PROBE soft-key in the PROBE menu (see Section 5.2.1). The coefficient values are normally provided with the probe on a calibration report. Be sure to select the proper range for ITS-90 characterizations.

### 8.3.3 Current

The 2561 sources current to the sensor and measures the resulting voltage across the sensor to determine its resistance. The current alternates every 0.5 seconds to reduce the effects of thermoelectric offsets. The normal current is 3.0 mA. The current can be changed to 5.0 mA to test self-heating effects using the **SET UP DEVICE** function in the **MODULE** menu (see Section 5.4.2). Change the **CURRENT** parameter from 3.0 to 5.0 and press **ENTER**.

The **SET UP DEVICE** function also allows access to one other parameter. **SAMP PER** selects the sample period between 2 (normal) and 10 seconds. The purpose of this option is mainly for troubleshooting and it should not be changed during normal operation.

### 8.3.4 Device Setup Commands

The `SYST:MODn:DEVn:READ?` and `SYST:MODn:DEVn:WRIT` commands (see Sections 6.5.8.19 and 6.5.8.20) can be used to read or set the setup parameters for the 2561 HTPRT Module. The device number of the HTPRT Input Device is 1. The module number for the 2561 module is its position in the stack. For example, if the 1560 has four add-on modules, the 2561 being first, the module number for the 2561 is 1. Table 24 shows the device commands used to read or set the setup parameters of the HTPRT Input Device.

Table 21. HTPRT Module Device Commands

Device Command	Parameter	Description
CURR	3, 5	Excitation current, mA
SAMP	2, 10	Sample period, seconds

Below are some examples of using the device commands to set the device setup parameters. For these examples it is assumed that the 2561 HTPRT Module is placed first in the stack. These commands can be sent through any communication interface including the IEEE-488 and RS-232 interfaces.

*SYST: MOD1:DEV1:WRIT "CURR",5 Set the excitation current to 5.0 mA.*

*SYST:MOD1:DEV1:READ? "CURR" Read the excitation current.*

## 8.4 Calibration

This section explains the calibration procedure for the 2561 HTPRT Module.

### 8.4.1 Calibration Parameters

The resistance measurement is derived from the ratio between the voltage measurements of the input resistor and the internal reference resistor (10 Ω) using the following equation.



$$resistance = (10.0 + 10\_ADJ) ratio + 0\_ADJ(1.0 - ratio)$$

Two adjustable calibration parameters are used for calibration: *0\_ADJ* and *10\_ADJ*. *0\_ADJ* directly affects the measurement at 0 Ω. It has negligible effect at 10 Ω. *10\_ADJ* directly affects the measurement at 10 Ω. It has negligible effect at 0 Ω. Each of the parameters has a positive effect at their primary resistances: increasing the value of the parameter increases the measured resistance. The default and theoretically normal value for each is 0.

### 8.4.2 Front-panel Access

The calibration parameters *0\_ADJ*, and *10\_ADJ* can be adjusted to optimize the accuracy. They can be accessed from the front panel of the 1560 using the **CAL DEVICE** soft-key function. This is found in the **MODULE** sub-menu. Pressing the **CAL DEVICE** soft-key shows a list of devices with the module position number. Use the UD buttons to move the cursor to the HTPRT module and press **ENTER**.

SELECT A DEVICE TO CALIBRATE	
>	HPRT 1
	TCS 2
	PRTS 3

After the device is selected a new window appears showing the parameters and functions available from the device. New values can be entered for the parameters using the numeric buttons and pressing **ENTER**. The   buttons can be used to move between parameters.

```
CALIBRATE DEVICE: HPRT
0 ADJ: 0.0
10 ADJ: 0.0
CAL DATE: 05-21-96
SER NUM: A38123
```

For the 2561 HTPRT module the list of parameters includes  $0\_ADJ$  and  $10\_ADJ$  as described above. The list also includes the calibration date (CAL DATE) parameter, used to record the date the module was calibrated, and the SER NUM parameter, used to record the serial number of the module.

### 8.4.3 Calibration Procedure

Calibration requires adjustment of the  $0\_ADJ$ , and  $10\_ADJ$  parameters at two specific input resistances. If the resistances used are approximately  $0\ \Omega$  and  $10\ \Omega$  respectively the adjustments are independent and the procedure is simple. Either channel can be used for calibration. Set the conversion type to  $R(\ \Omega )$  to display resistance (see Section 5.2.1.1 ). The accuracy required of the resistance standards is 1/4 of the instrument accuracy: that is  $\pm 0.000025\ \Omega$  at  $0\ \Omega$  and  $\pm 0.00012\ \Omega$  (12 ppm) at  $10\ \Omega$ . The recommended procedure is as follows:

1. Connect a  $0\ \Omega$  resistor to the input and measure its resistance. If a shorting wire is used, the wire should run from the inside black terminal to the inside red terminal to the outside red terminal then back across to the outside black terminal. Note the average error in the measurement. Adjust the  $0\_ADJ$  parameter by subtracting the measured error. For example, if the input is exactly  $0.0\ \Omega$  and readout shows  $-0.211\text{m}\ \Omega$ ,  $0\_ADJ$  should be adjusted by adding  $0.000211$  to it.
2. Connect a  $10\ \Omega$  resistor (12 ppm accuracy) to the input and measure its resistance. Note the average error in the measurement. Adjust the  $10\_ADJ$  parameter by subtracting the measured error. For example, if the input is exactly  $10.0\ \Omega$  and the readout shows  $10.02955\ \Omega$ ,  $10\_ADJ$  should be adjusted by subtracting  $0.02955$  from it.
3. Record the date with the calibration date parameter.
4. Verify the accuracy at  $0\ \Omega$ ,  $1\ \Omega$  or  $25\ \Omega$ ,  $10\ \Omega$ , and  $25\ \Omega$ . Verify the accuracy of both channels with selected resistances. The accuracy must be within the short-term accuracy given in the specifications.



## **Chapter 9**

# **2562/2568 PRT Scanner Module**

This section explains the features and operation of the optional 2562/2568 PRT Scanner Module.

### **9.1 Description**

The 2562/2568 PRT Scanner Module is an add-on module that allows the 1560 to measure temperature with up to eight SPRT, PRT, and RTD sensors. The modules accept two-, three-, or four-wire sensors with nominal resistance of 25 and 100  $\Omega$  (2562) or 500 and 1K  $\Omega$  (2568). The excitation current alternates polarity to minimize the effects of thermoelectric offsets. Up to eight sensors can be connected to the 2562/2568 simultaneously and measured alternately.

## 9.2 Specifications

	2562	2568
Resistance range	0 to 400 $\Omega$	0 to 4 k $\Omega$
Resistance accuracy, one-year (Using four-wire connection) <sup>1, 3</sup>	0 to 25 $\Omega$ : 0.001 $\Omega$ 25 to 400 $\Omega$ : 40 ppm of reading	0 to 250 $\Omega$ : 0.01 $\Omega$ 250 to 4K $\Omega$ : 40 ppm of reading
Resistance accuracy, short-term (Using four-wire connection) <sup>1, 2, 3</sup>	0 to 25 $\Omega$ : 0.0005 $\Omega$ 25 to 400 $\Omega$ : 20 ppm of reading	0 to 250 $\Omega$ : 0.0075 $\Omega$ 250 to 4K $\Omega$ : 30 ppm of reading
Temperature accuracy, one-year (Using four-wire connection, not including probe uncertainty) <sup>1, 3</sup>		
-100 °C		$\pm 0.006$ °C
0 °C		$\pm 0.010$ °C
100 °C		$\pm 0.014$ °C
200 °C		$\pm 0.020$ °C
300 °C		$\pm 0.024$ °C
400 °C		$\pm 0.028$ °C
500 °C		$\pm 0.034$ °C
600 °C		$\pm 0.040$ °C
Temperature coefficient <sup>1</sup>	0.5 ppm/ °C	2.5 ppm/ °C
Excitation current	1.0, 1.4 mA; 1 Hz	0.1, 0.05 mA; 1 Hz
Maximum lead resistance	100 $\Omega$	
Sample time	2 seconds	
Number of channels	8	
Recommended operating temperature range <sup>1</sup>	18 to 28 °C (64 to 82 °F)	
Absolute operating temperature range	5 to 35 °C (40 to 95 °F)	
Weight	2.5 lbs. (1.1 kg)	
<p><sup>1</sup> The accuracy specifications apply within the recommended operating temperature range. Accuracy limits are increased by a factor of the temperature coefficient outside this range.</p> <p><sup>2</sup> Short-term accuracy includes nonlinearity and noise uncertainties. It does not include drift or calibration uncertainties.</p> <p><sup>3</sup> Add 0.01 <math>\Omega</math> to accuracy limits when using 3-wire sensors.</p>		

**9.3 Operation**

Using the 2562/2568 PRT Scanner Module with the 1560 Black Stack is very simple. The following sections explain the steps for setting up and using the 2562/2568 to measure with PRTs. For instructions on installing the 2562/2568 PRT Scanner Module onto the 1560 see Section 4.1.

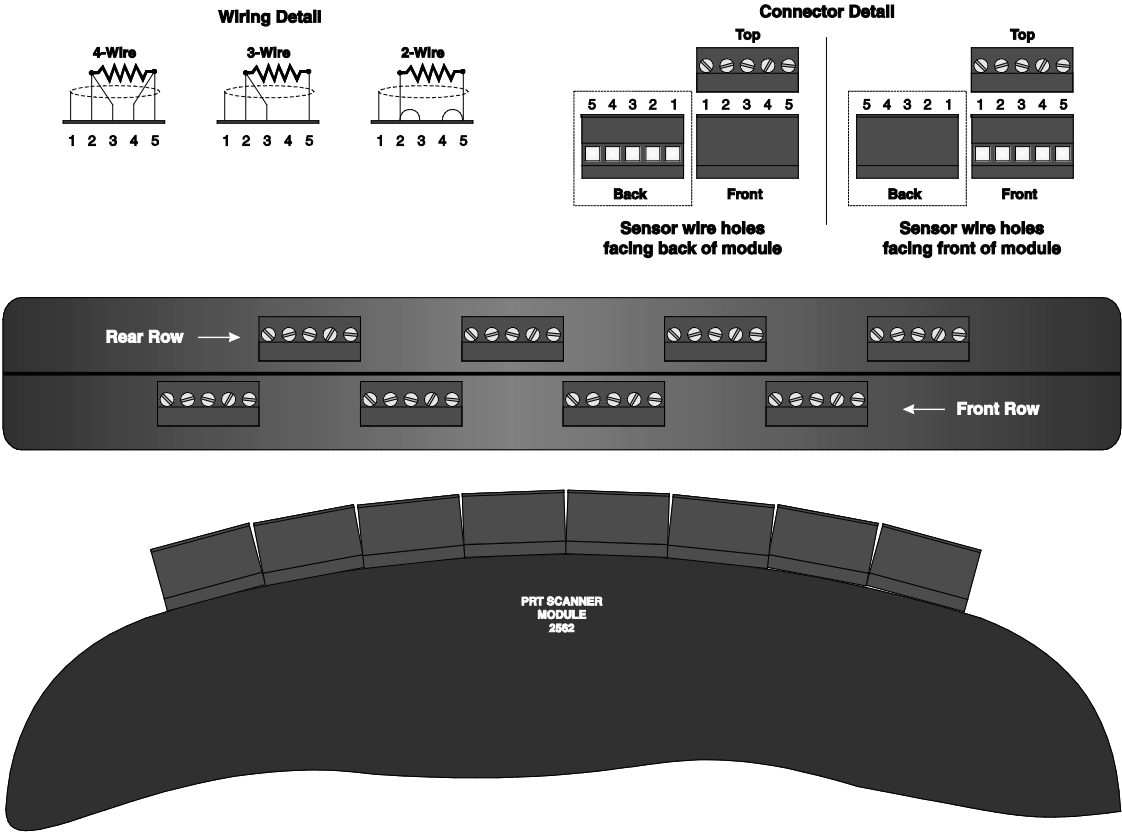





Figure 15. PRT Scanner Module Sensor Wiring Detail

**9.3.1 Wire Configuration**

The 2562/2568 PRT Scanner Module can accept sensors with two, three, or four wires but all the sensors connected to the same row must be of the same type. The connectors are arranged in two rows—front and rear. Each row can be independently configured for four-wire (or two-wire) or three-wire operation. The wiring type is selected using the **SET UP DEVICE** function in the **MODULE** soft-key menu (see Section 5.4.2). Select the PRTS device. A window appears showing the setup parameters for the 2562/2568 Module:

```

SET UP DEVICE: PRTS 3
CURRENT: 1.0
WIRES FR: 4
WIRES RR: 4
SAMP PER: 2
RES RANGE: AUTO
    
```

Select the wiring type for the front row and rear row with the WIRES FR and WIRES RR parameters respectively. Move the cursor from line to line with the   buttons. The values of parameters can be changed using the   buttons. Press **ENTER** to set the parameter. If 3 is selected for one row all the sensors connected on that row must be three-wire. If 4 is selected for one row all the sensors connected on that row must be two-wire or four-wire.

### 9.3.2 Connecting a Probe

Four-wire sensors are connected as shown in Figure 15. The shield, if used, is connected to pin 1 on the left. One pair of wires connects to pins 2 and 3. The opposite pair of wires connects to pins 4 and 5. Pins 2 and 5 source current and pins 3 and 4 sense potential. When using four-wire sensors be sure to check that the wiring configuration for that row is set to 4 as explained above!

#### *Note*

*There are two types of sensor connectors. One has the wire holes facing the front of the module and one has the wire holes facing the back of the module as shown in the connector details in Figure 15.*

Three-wire sensors are connected as shown in Figure 15. The shield, if used, is connected to pin 1 on the left. One pair of wires connects to pins 2 and 3 from the left. The opposite wire connects to pin 5. Pin 4 is left unconnected. Pins 2 and 5 source current. The potential is also sensed at pins 2 and 5 while the potential at pin 3 is used to compensate for the lead resistances of wires 2 and 5. Be sure to check that the wiring configuration for that row is set to 3 as explained previously! When using three-wire sensors the accuracy is reduced as shown in the specifications. Also, be aware that any difference between the resistances of the lead wires directly affects accuracy.

Two-wire sensors are connected as shown in Figure 15. The shield, if used, is connected to pin 1 on the left. One wire connects to both pins 2 and 3 from the left. The opposite wire connects to both pins 4 and 5. Be sure to check that the wiring configuration for that row is set to 4 as explained above! When using two-wire sensors the 2562/2568 is unable to compensate for lead resistance.

### 9.3.3 Setting Coefficients

Once a PRT or SPRT probe is properly connected to the 2562/2568, the 1560 can read out its resistance. To display temperature accurately the 1560 must be programmed with the characterization coefficients for the sensor. This is done using the **EDIT PROBE** soft-key in the **PROBE** menu (see Section 5.2.1). The coefficient values are normally provided with the probe on a calibration report. Be sure to select the proper range for ITS-90 characterizations. If IEC-751 RTDs are used you may select the CVD conversion and use R0: 100, ALPHA: 0.00385, DELTA: 1.507, and BETA: 0.111.



### 9.3.4 Current

The 2562/2568 sources current to the sensor and measures the resulting voltage across the sensor to determine its resistance. The current alternates every 0.5 seconds to reduce the effects of thermoelectric offsets. The normal current is 1.0 mA. The current can be changed to 1.4 mA to test self-heating effects using the **SET UP DEVICE** function in the **MODULE** menu (see Section 5.4.2). Change the **CURRENT** parameter from 1.0 to 1.4 and press **ENTER**.

The **SET UP DEVICE** function also allows access to two other parameters. **SAMP PER** selects the sample period between 2 (normal) and 10 seconds. **RES RANGE** sets the resistance range between **AUTO** ranging (normal), **LOW** range, and **HIGH** range. The purpose of these options is mainly for trouble-shooting and they should not need to be changed during normal operation.

### 9.3.5 Device Setup Commands

The **SYST:MODn:DEVn:READ?** and **SYST:MODn:DEVn:WRIT** commands (see Sections 6.5.8.19 and 6.5.8.20) can be used to read or set the setup parameters for the 2562/2568 PRT Scanner Module. The device number of the PRT Scanner Input Device is 1. The module number for the 2562/2568 module is its position in the stack. For example, if the 1560 has four add-on modules, the 2562/2568 being second, the module number for the 2562/2568 is 2. Table 25 shows the device commands used to read or set the setup parameters of the PRT Scanner Input Device.

Table 22. PRT Scanner Commands

Device Command	Parameter	Description
CURR	1, 1.4 (2562) 0.1, 0.05 (2568)	Excitation current, mA
WIRF	3, 4	Front-row wire configuration
WIRR	3, 4	Rear-row wire configuration
SAMP	2, 10	Sample period, seconds
ARNG	AUTO, LOW, HIGH	Resistance range

Below are some examples of using the device commands to set the device setup parameters. For these examples it is assumed that the 2562/2568 PRT Scanner Module is placed second in the stack. These commands can be sent through any communication interface including the IEEE-488 and RS-232 interfaces.

*SYST:MOD2:DEV1:WRIT "CURR",1.4 Set the excitation current to 1.4 mA.*

*SYST:MOD2:DEV1:READ? "CURR" Read the excitation current.*

*SYST:MOD2:DEV1:WRIT "WIRF",3 Set the front-row configuration to three-wire.*

## 9.4 Calibration

This section explains the calibration procedure for the 2562/2568 PRT Scanner Module.



### 9.4.1 Calibration Parameters

Three adjustable parameters are used for calibration: 0\_ADJ, 100\_ADJ, and 400\_ADJ. 0\_ADJ directly affects the measurement at 0  $\Omega$ . It has negligible effect at 100  $\Omega$  but significant affect at higher resistances. 100\_ADJ directly affects the measurement at 100  $\Omega$ . It has negligible effect at 0  $\Omega$  and proportionately greater effect the higher the resistance. 400\_ADJ directly affects the measurement at 400. It has negligible effect at 0  $\Omega$  and 100  $\Omega$  with greater effect the more the resistance deviates from 0  $\Omega$  or 100  $\Omega$ . Each of the parameters has positive effect at their primary resistances: increasing the value of the parameter increases the measured resistance. The default and theoretically normal value for each is 0.

### 9.4.2 Front-Panel Access

The calibration parameters 0\_ADJ, 100\_ADJ, and 400\_ADJ can be adjusted to optimize the accuracy. They can be accessed from the front panel of the 1560 using the **CAL DEVICE** function in the **MODULE** soft-key menu (see Section 5.4.3). Select the PRTS device. A window appears showing the calibration parameters for the device.

```
CALIBRATE DEVICE: PRTS
-----
0 ADJ: 0.0
100 ADJ: 0.0
400 ADJ: 0.0
CAL DATE: 09-21-95
SER NUM: A31123
```

For the 2562/2568 PRT Scanner module the list of parameters includes 0\_ADJ, 100\_ADJ, and 400\_ADJ as described above. The list also includes the calibration date (CAL DATE) parameter, used to record the date the module was calibrated, and the serial number (SER NUM) parameter, used to record the serial number of the module. New values can be entered for the parameters using the numeric buttons and pressing **ENTER**. The   buttons can be used to move between parameters.

### 9.4.3 Calibration Procedure (2562)

Calibration requires adjustment of the 0\_ADJ, 100\_ADJ, and 400\_ADJ parameters at three specific input resistances. If the resistances used are approximately 0  $\Omega$ , 100  $\Omega$  and 400  $\Omega$  respectively the adjustments are independent and the procedure is simple. The order in which the adjustments are performed is important. The adjustment of the 400\_ADJ parameter must be done last as the adjustments of 0\_ADJ and 100\_ADJ affect the measurement at 400  $\Omega$  but 400\_ADJ does not affect the measurements at 0  $\Omega$  or 100  $\Omega$ . Any channel can be used for calibration. Set the conversion type to R(  $\Omega$  ) to display resistance (see Section 5.2.1.1). The calibration should be performed with four-wire connection and with the wiring configuration set up for four-wire (see Section 9.3.1). The accuracy required of the resistance standards is 1/4 of the instrument accuracy; that is  $\pm 0.00025 \Omega$  at 0  $\Omega$ ,  $\pm 0.001 \Omega$  (10 ppm) at 100  $\Omega$ , and  $\pm 0.004 \Omega$  (10 ppm) at 400  $\Omega$ . The recommended procedure is as follows:

1. Connect a 0  $\Omega$  resistor to the input and measure its resistance. If a shorting wire is used the wire should run from pin 3 from the left to pin 4 to pin 5 then back across to pin 2. Note the average error in the measurement. Adjust the 0\_ADJ parameter by subtracting the measured error. For example, if the input is exactly 0.0000 and readout shows  $-0.0011$ , 0\_ADJ should be adjusted by adding 0.0011 to it.
2. Connect a 100  $\Omega$  resistor (10 ppm accuracy) to the input and measure its resistance. Note the average error in the measurement. Adjust the 100\_ADJ parameter by subtracting the measured error. For example, if the input is exactly 100.0000  $\Omega$  and the readout shows 100.0295  $\Omega$ , 100\_ADJ should be adjusted by subtracting 0.0295 from it.
3. Connect a 400  $\Omega$  resistor (10 ppm accuracy) to the input and measure its resistance. Note the average error in the measurement. Adjust the 400\_ADJ parameter by subtracting the measured error. For example, if the input is exactly 400.0000  $\Omega$  and the readout shows 399.9913  $\Omega$ , 400\_ADJ should be adjusted by adding 0.0087 to it.
4. Record the date with the calibration date parameter.
5. Verify the accuracy at 0  $\Omega$ , 25  $\Omega$  or 50  $\Omega$ , 100  $\Omega$ , 200  $\Omega$ , and 400  $\Omega$  on selected channels. Verify at least one resistance on each channel. The accuracy must be within the short-term accuracy given in the specifications.
6. Set the wiring configuration of both rows to three-wire (see Section 9.3.1). Verify the accuracy with at least one resistance on each channel. The accuracy must be within the short-term accuracy plus the additional three-wire uncertainty as given in the specifications.

### 9.4.4 Calibration Procedure (2568)

The calibration procedure for the 2568 Module is the same as the 2562 except the parameters 0\_ADJ, 1K\_ADJ, and 4K\_ADJ are used to calibrate the measurement at 0  $\Omega$ , 1K  $\Omega$ , and 4K  $\Omega$  respectively.



# Chapter 10

## 2563 Thermistor Module

This section explains the features and operation of the optional 2563 Thermistor Module.

### 10.1 Description

The 2563 Thermistor Module is an add-on module that allows the 1560 to measure temperature with thermistor sensors. It is capable of measuring temperature with very high accuracy, to 0.0013 °C. It accepts nearly every type of thermistor sensor, two or four-wire. It uses very small excitation currents to minimize sensor self-heating. The excitation current alternates polarity to minimize the effects of thermoelectric offsets. Two thermistor sensors can be connected to the 2563 simultaneously and measured alternately.

### 10.2 Specifications

<b>Resistance range</b>	0 to 1 M $\Omega$
<b>Resistance accuracy, one-year<sup>1</sup></b> 0 to 2k $\Omega$ 2k to 100k $\Omega$ 100k $\Omega$ to 1 M $\Omega$	0.1 $\Omega$ 50 ppm of reading 200 ppm of reading
<b>Resistance accuracy, short-term<sup>1,2</sup></b> 0 to 2k $\Omega$ 2k to 100k $\Omega$ 100k $\Omega$ to 1 M $\Omega$	0.08 $\Omega$ 40 ppm of reading 180 ppm of reading
<b>Temperature accuracy (with 10k <math>\Omega</math>, <math>\alpha = -0.04</math> sensor; not including sensor uncertainty)<sup>1</sup></b> 0 °C 25 °C 50 °C 75 °C 100 °C	$\pm 0.0013$ °C $\pm 0.0013$ °C $\pm 0.0013$ °C $\pm 0.0015$ °C $\pm 0.003$ °C
<b>Temperature coefficient<sup>1</sup></b>	2.5 ppm/ °C

<b>Excitation current</b>	2.0,10.0 $\mu$ A; automatically selected; 1 Hz
<b>Maximum lead resistance</b>	100 $\Omega$
<b>Sample time</b>	2 seconds
<b>Number of channels</b>	2
<b>Recommended operating temperature range<sup>1</sup></b>	18 to 28 °C (64 to 82 °F)
<b>Absolute operating temperature range</b>	5 to 35 °C (40 to 95 °F)
<b>Weight</b>	2 lbs. (0.9 kg.)
<sup>1</sup> The accuracy specifications apply within the recommended operating temperature range. Accuracy limits are increased by a factor of the temperature coefficient outside this range. <sup>2</sup> Short-term accuracy includes nonlinearity and noise uncertainties. It does not include drift or calibration uncertainties.	

## 10.3 Operation

Using the 2563 Thermistor Module with the 1560 Black Stack is very simple. The following sections explain the steps for setting up and using the 2563 to measure with thermistors. For instructions for installing the 2563 Thermistor Module onto the 1560 see Section 4.1.

### 10.3.1 Connecting a Thermistor

The 2563 Thermistor Module has ten terminal posts; five each for the two channels (see Figure 16). The red terminals connect to one side of the sensor. One sources current and the other senses the voltage. The black terminals connect to the other side of the sensor. One sources current and the other senses the voltage. The green terminal connects to ground and can be used to ground a shield wire. Two thermistors can be connected to the 2563 at once.

To connect two-wire thermistors to one channel, connect one wire to both red terminals and the other wire to both black terminals. If there is a shield or guard wire connect it to the green terminal.

To connect four-wire thermistors to one channel, connect the wires from one common pair (wires that are shorted together at the sensor element) to the red terminals and the wires from the other pair to the black terminals. If there is a shield or guard wire connect it to the green terminal.

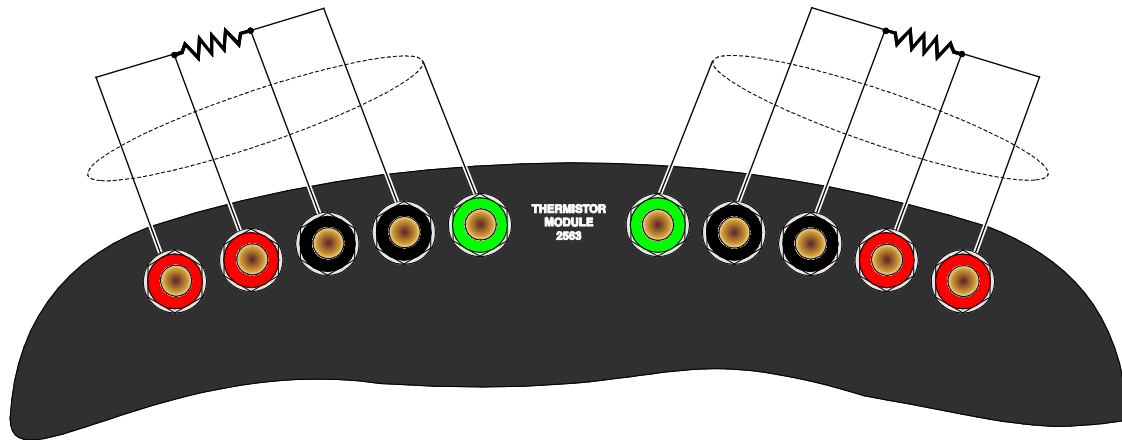

Figure 16. Sensor Wiring Diagram

### 10.3.2 Setting Coefficients

Once a thermistor is properly connected to the 2563, the 1560 can read out its resistance. To display temperature accurately, the 1560 must be programmed with the characterization coefficients for the sensor. This is done using the **EDIT PROBE** soft-key in the **PROBE** menu (see Section 5.2.1). The coefficient values are normally provided with the probe on a calibration report. Be sure to select the proper equation type, R(T) or T(R).

### 10.3.3 Current

The 2563 sources current to the sensor and measures the resulting voltage across the sensor to determine its resistance. The current alternates every 0.5 seconds to reduce the effects of thermoelectric offsets. The current automatically switches between 2  $\mu\text{A}$  and 10  $\mu\text{A}$  depending on the resistance being measured. At lower resistances (below about 50 k  $\Omega$ ) 10  $\mu\text{A}$  is used. At higher resistances 2  $\mu\text{A}$  is used. You can force the current source to use 2  $\mu\text{A}$  for low resistances, if necessary, using the **SET UP DEVICE** function in the **MODULE** menu (see Section 5.4.2). Change the **CURRENT** parameter from **AUTO** to 2.0 and press **ENTER**.

The **SET UP DEVICE** function also allows access to two other parameters. **SAMP PER** selects the sample period between 2 (normal) and 10 seconds. **RES RANGE** sets the resistance range between **AUTO** ranging (normal), **LOW** range, and **HIGH** range. The purpose of these options is mainly for trouble-shooting and they should not need to be changed during normal operation.

### 10.3.4 Device Setup Commands

The SYST:MODn:DEVn:READ? and SYST: MODn:DEVn:WRIT commands (see Sections 6.5.8.19 and 6.5.8.20) can be used to read or set the setup parameters for the 2563 Thermistor Module. The device number of the Thermistor Input Device is 1. The module number for the 2563 module is its position in the stack. For example, if the 1560 has four add-on modules, the 2563 being third, the module number for the 2563 is 3. Table 26 shows the device commands used to read or set the setup parameters of the Thermistor Input Device.

Below are some examples of using the device commands to set the device setup parameters. For these examples it is assumed that the 2563 Thermistor Input

**Table 23. Thermistor Module Device Commands**

Device Command	Parameter	Description
CURR	AUTO, 2, 10	Excitation current, $\mu$ A
SAMP	2, 10	Sample period, seconds
ARNG	AUTO, LOW, HIGH	Resistance range

Module is placed third in the stack. These commands can be sent through any communication interface including the IEEE-488 and RS-232 interfaces.

SYST:MOD2:DEV1:WRIT "CURR",2 Set the excitation current to 2  $\mu$ A.

SYST:MOD2:DEV1:READ? "CURR" Read the excitation current.

## 10.4 Calibration

This section explains the calibration procedure for the 2563 Thermistor Module.

### 10.4.1 Calibration Parameters



The resistance measurement is derived from the ratio between the voltage measurements of the input resistor and reference resistor (20 k  $\Omega$ ) using the following equation.

$$resistance = \left[ 1.111 \cdot 10^{-6} \times (100K\_ADJ)(2.0ratio - 10) + 1.0 \right] \\ \left[ (1.0 \cdot 10^4 + 10K\_ADJ)2.0ratio + 0\_ADJ(1.0 - 1.0ratio) \right]$$



Three adjustable parameters are used for calibration: *0\_ADJ*, *10K\_ADJ*, and *100K\_ADJ*. *0\_ADJ* directly affects the measurement at 0  $\Omega$ . It has negligible effect at 10 k  $\Omega$  but significant affect at higher resistances. *10K\_ADJ* directly affects the measurement at 10 k  $\Omega$ . It has negligible effect at 0  $\Omega$  and proportionately greater effect the higher the resistance. *100K\_ADJ* directly affects the measurement at 100 k  $\Omega$ . It has negligible effect at 0  $\Omega$  and 10 k  $\Omega$  with greater effect the more the resistance deviates from 0  $\Omega$  or 10 k  $\Omega$ . Each of the parameters has positive effect at their primary resistances: increasing the value of the parameter increases the measured resistance. The default and theoretically normal value for each is 0.



### 10.4.2 Front-panel Access

The calibration parameters *0\_ADJ*, *10K\_ADJ*, and *100K\_ADJ* can be adjusted to optimize the accuracy. They can be accessed from the front panel of the 1560 using the **CAL DEVICE** soft-key function. This is found in the **MODULE** sub-menu. Pressing the **CAL DEVICE** soft-key shows a list of devices with the module position number. Use the   buttons to move the cursor to the STHR module and press **ENTER**.

```
SELECT A DEVICE TO CALIBRATE
-----
>SPRT 1
  TCS  2
  STHR 3
```

After the device is selected a new window appears showing the parameters and functions available from the device. New values can be entered for the parameters using the numeric buttons and pressing **ENTER**. The   buttons can be used to move between parameters.

```
CALIBRATE DEVICE: STHR
0 ADJ: 0.0
10K ADJ: 0.0
100K ADJ: 0.0
CAL DATE: 05-21-96
SER NUM: A29123
```

For the 2563 Thermistor module the list of parameters includes *0\_ADJ*, *10K\_ADJ*, and *100K\_ADJ* as described above. The list also includes the calibration date (CAL DATE) parameter, used to record the date the module was calibrated, and the serial number parameter (SER NUM), used to record the serial number of the module.

### 10.4.3 Calibration Procedure

Calibration requires adjustment of the *0\_ADJ*, *10K\_ADJ*, and *100K\_ADJ* parameters at three specific input resistances. If the resistances used are approximately 0  $\Omega$ , 10 k  $\Omega$  and 100 k  $\Omega$  respectively the adjustments are independent and the procedure is simple. The order in which the adjustments are performed is important. The adjustment of the *100K\_ADJ* parameter must be performed last as the adjustments of *0\_ADJ* and *10K\_ADJ* affect the measurement at 100 k  $\Omega$  but *100K\_ADJ* does not affect the measurements at 0  $\Omega$  and 10 k  $\Omega$ . Either channel can be used for calibration. Set the conversion type to R(W) to display resistance (see Section 5.2.1.1 ). The accuracy required of the resistance standards is 1/4 of the instrument accuracy: that is  $\pm 0.025 \Omega$  at 0  $\Omega$ ,  $\pm 0.12 \Omega$  (12 ppm) at 10k  $\Omega$ , and  $\pm 1.2 \Omega$  (12 ppm) at 100 k  $\Omega$ . The recommended procedure is as follows:

1. Connect a 0  $\Omega$  resistor to the input and measure its resistance. If a shorting wire is used, the wire should run from the inside black terminal to the inside red terminal to the outside red terminal then back across to the outside black terminal. Note the average error in the measurement. Adjust the *0\_ADJ* parameter by subtracting the measured error. For example, if the input is exactly 0.0  $\Omega$  and readout shows -0.11 $\Omega$ , *0\_ADJ* should be adjusted by adding 0.11 to it.
2. Connect a 10 k  $\Omega$  resistor (12 ppm accuracy) to the input and measure its resistance. Note the average error in the measurement. Adjust the *10K\_ADJ* parameter by subtracting the measured error. For example, if the input is exactly 10.00000 k  $\Omega$  and the readout shows 10.00295 k  $\Omega$ , *10K\_ADJ* should be adjusted by subtracting 2.95 from it.
3. Connect a 100 k  $\Omega$  resistor (12 ppm accuracy) to the input and measure its resistance. Note the average error in the measurement. Adjust the *100K\_ADJ* parameter by subtracting the measured error. For example, if the input is exactly 100.0000 k  $\Omega$  and the readout shows 99.9913 k  $\Omega$ , *100K\_ADJ* should be adjusted by adding 8.7 to it.
4. Record the date with the calibration date parameter.
5. Verify the accuracy at 0  $\Omega$ , 4k  $\Omega$ , 10k  $\Omega$ , 40k  $\Omega$ , 100k  $\Omega$ , and 1M  $\Omega$  on both channels. Verify the accuracy of both channels with selected resistances. The accuracy must be within the short-term accuracy given in the specifications.

# Chapter 11

## 2564 Thermistor Scanner Module

This section explains the features and operation of the optional 2564 Thermistor Scanner Module.

### 11.1 Description

The 2564 Thermistor Scanner Module is an add-on module that allows the 1560 to measure temperature with up to eight thermistors. It accepts nearly every type of thermistor sensor with two, three, or four wires. It uses very small excitation currents to minimize sensor self-heating. The excitation current alternates polarity to minimize the effects of thermoelectric offsets. Up to eight sensors can be connected to the 2564 simultaneously and measured alternately.

### 11.2 Specifications

<b>Resistance range</b>	0 to 1 M $\Omega$
<b>Resistance accuracy, one-year<sup>1</sup></b> 0 to 2 k $\Omega$ 2 to 100 k $\Omega$ 100 k $\Omega$ to 1 M $\Omega$	0.2 $\Omega$ 100 ppm of reading 300 ppm of reading
<b>Resistance accuracy, short-term<sup>1, 2</sup></b> 0 to 2 k $\Omega$ 2 to 100 k $\Omega$ 100 k $\Omega$ to 1 M $\Omega$	0.15 $\Omega$ 75 ppm of reading 250 ppm of reading
<b>Temperature accuracy, one-year (with 10k <math>\Omega</math>, <math>\alpha = 0.04</math> sensor; not including sensor uncertainty)<sup>1</sup></b> 0 $^{\circ}\text{C}$ 25 $^{\circ}\text{C}$ 50 $^{\circ}\text{C}$ 75 $^{\circ}\text{C}$ 100 $^{\circ}\text{C}$	$\pm 0.0025$ $^{\circ}\text{C}$ $\pm 0.0025$ $^{\circ}\text{C}$ $\pm 0.0025$ $^{\circ}\text{C}$ $\pm 0.003$ $^{\circ}\text{C}$ $\pm 0.006$ $^{\circ}\text{C}$
<b>Temperature coefficient</b>	2.5 ppm/ $^{\circ}\text{C}$
<b>Excitation current</b>	2, 10 $\mu\text{A}$ ; automatically selected: 1 Hz
<b>Maximum lead resistance</b>	100 $\Omega$
<b>Sample time</b>	2 seconds
<b>Number of channels</b>	8
<b>Recommended operating temperature range<sup>1</sup></b>	18 to 28 $^{\circ}\text{C}$ (64 to 82 $^{\circ}\text{F}$ )
<b>Absolute operating temperature range</b>	5 to 35 $^{\circ}\text{C}$ (40 to 95 $^{\circ}\text{F}$ )
<b>Weight</b>	2.5 lbs. (1.1 kg.)
<sup>1</sup> The accuracy specifications apply within the recommended operating temperature range. Accuracy limits are increased by a factor of the temperature coefficient outside this range. <sup>2</sup> Short-term accuracy includes nonlinearity and noise uncertainties. It does not include drift or calibration uncertainties.	

## 11.3 Operation

Using the 2564 Thermistor Scanner Module with the 1560 Black Stack is very simple. The following sections explain the steps for setting up and using the 2564 to measure with thermistors. For instructions for installing the 2564 Thermistor Scanner Module onto the 1560 see Section 4.1.

### 11.3.1 Wire Configuration

The 2564 Thermistor Scanner Module can accept sensors with two, three, or four wires but all the sensors connected to the same row must be of the same type. The connectors are arranged in two rows—front and rear. Each row can be independently configured for four-wire (or two-wire) or three-wire operation. The wiring type is selected using the **SET UP DEVICE** function in the **MODULE** soft-key menu (see Section 5.4.2). Select the THRS device. A window appears showing the setup parameters for the 2564 Module:

<b>SET UP DEVICE: THRS 3</b>	
CURRENT( $\mu$ A): AUTO	◀▶
WIRES FR: 4	
WIRES RR: 4	
SAMP PER: 2	
RES RANGE: AUTO	

Select the wiring type for the front row and rear row with the WIRES FR and WIRES RR parameters respectively. Move the cursor from line to line with the **▲▼** buttons. The values of parameters can be changed using the **◀▶** buttons. Press **ENTER** to set the parameter. If 3 is selected for one row all the sensors connected on that row must be three-wire. If 4 is selected for one row all the sensors connected on that row must be two-wire or four-wire.

### 11.3.2 Connecting a Probe

Four-wire sensors are connected as shown in Figure 17. The shield, if used, is connected to pin 1 on the left. One pair of wires connects to pins 2 and 3. The opposite pair of wires connects to pins 4 and 5. Pins 2 and 5 source current and pins 3 and 4 sense potential. When using four-wire sensors be sure to check that the wiring configuration for that row is set to 4 as explained above!

#### Note

*There are two types of sensor connectors. One has the wire holes facing the front of the module and one has the wire holes facing the back of the module as shown in the connector details in Figure 17.*

Three-wire sensors are connected as shown in Figure 17. The shield, if used, is connected to pin 1 on the left. One pair of wires connects to pins 2 and 3. The opposite wire connects to pin 5. Pin 4 is left unconnected. Pins 2 and 5 source current. The potential is also sensed at pins 2 and 5 while the potential at pin 3 is used to compensate for the lead resistance of wires 2 and 5. Be sure to check that the wiring configuration for that row is set to 3 as explained above! Two-wire sensors are connected as shown in Figure 17. The shield, if used, is connected to pin 1 on the left. One wire connects both pins 2 and 3. The opposite wire connects to both pins 4 and 5. Be sure to check that the wiring configuration for that row is set to 4 as explained above! When using two-wire sensors the 2564 is unable to compensate for lead resistance.

### 11.3.3 Setting Coefficients

Once a thermistor is properly connected to the 2564, the 1560 can read out its resistance. To display temperature accurately the 1560 must be programmed with the characterization coefficients for the sensor. This is done using the

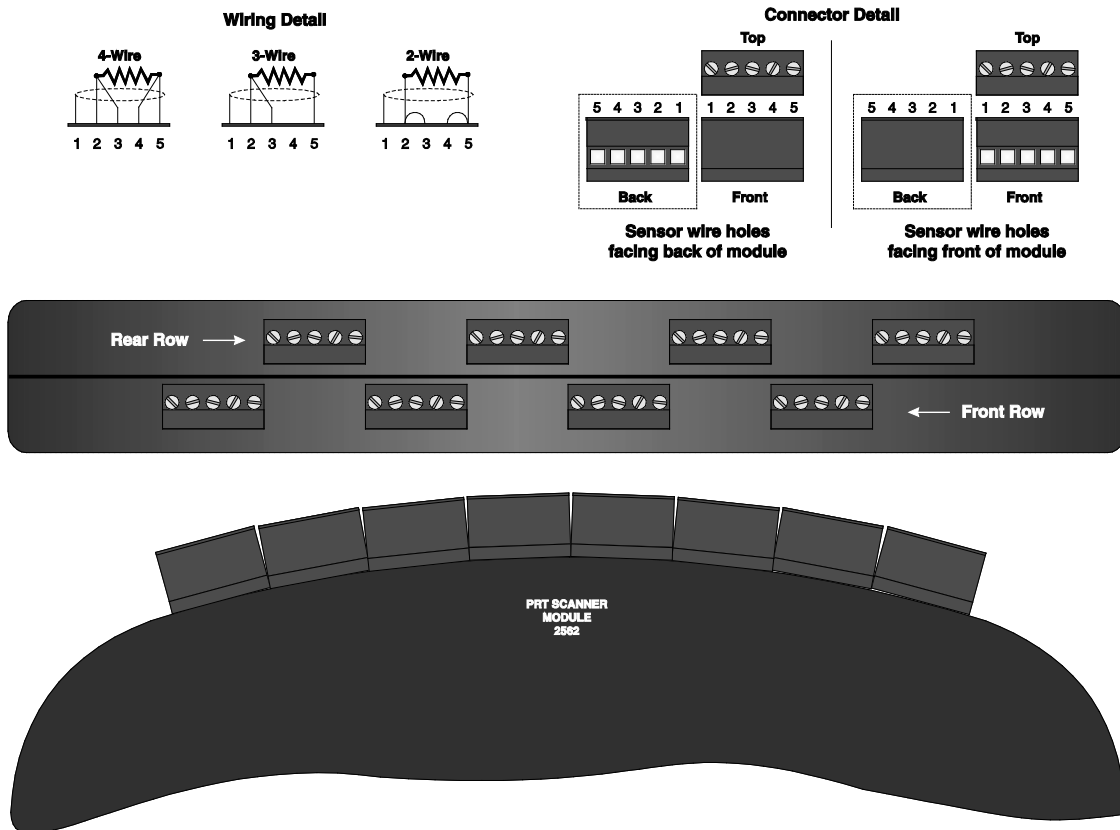

Figure 17. Thermistor Scanner Module Sensor Wiring Detail

**EDIT PROBE** soft-key in the **PROBE** menu (see Section 5.2.1). The coefficient values are normally provided with the probe on a calibration report. Be sure to select the proper equation type, R(T) or T(R).

### 11.3.4 Current

The 2564 sources current to the sensor and measures the resulting voltage across the sensor to determine its resistance. The current alternates every 0.5 seconds to reduce the effects of thermoelectric offsets. The current automatically switches between 2  $\mu$ A and 10  $\mu$ A depending on the resistance being measured. At lower resistances (below about 50 k  $\Omega$ ) 10  $\mu$ A is used. At higher resistances 2  $\mu$ A is used. You can force the current source to use 2  $\mu$ A for low resistances if necessary using the **SET UP DEVICE** function in the **MODULE** menu (see Section 5.4.2). Change the CURRENT parameter from AUTO to 2.0 and press **ENTER**.

The **SET UP DEVICE** function also allows access to two other parameters. SAMP PER selects the sample period between 2 (normal) and 10 seconds. RES RANGE sets the resistance range between AUTO ranging (normal), LOW range, and HIGH range. The purpose of these options is mainly for trouble-shooting and they should not need to be changed during normal operation.

### 11.3.5 Device Setup Commands

The SYST:MODn:DEVn:READ? and SYST: MODn:DEVn:WRIT commands (see Sections 6.5.8.19 and 6.5.8.20) can be used to read or set the setup parameters for the 2564 Thermistor Scanner Module. The device number of the Thermistor Scanner Input Device is 1. The module number for the 2564 module is its position in the stack. For example, if the 1560 has four add-on modules, the 2564 being second, the module number for the 2564 is 2. Table 27 shows the device commands used to read or set the setup parameters of the Thermistor Scanner Input Device.

Below are some examples of using the device commands to set the device setup parameters. For these examples it is assumed that the 2563 Thermistor Scanner Module is placed second in the stack. These commands can be sent through any communication interface including the IEEE-488 and RS-232 interfaces.

*SYST:MOD2:DEV1:WRIT "CURR",2 Set the excitation current to 2  $\mu$ A.*

*SYST:MOD2:DEV1:READ? "CURR" Read the excitation current.*

*SYST:MOD2:DEV1:WRIT "WIRF",4 Set the front-row configuration to four-wire.*

**Table 24. Thermistor Scanner Module Commands**

Device Command	Parameter	Description
CURR	AUTO, 2, 10	Excitation current, $\mu$ A
WIRF	3, 4	Front-row wire configuration
WIRR	3, 4	Rear-row wire configuration
SAMP	2, 10	Sample period, seconds
ARNG	AUTO, LOW, HIGH	Resistance range

## 11.4 Calibration

This section explains the calibration procedure for the 2564 Thermistor Scanner Module.

### 11.4.1 Calibration Parameters

Three adjustable parameters are used for calibration: 0\_ADJ, 10K\_ADJ, and 100K\_ADJ. 0\_ADJ directly affects the measurement at 0  $\Omega$ . It has negligible effect at 10 k  $\Omega$  but significant affect at higher resistances. 10K\_ADJ directly affects the measurement at 10 k  $\Omega$ . It has negligible effect at 0  $\Omega$  and proportionately greater effect the higher the resistance. 100K\_ADJ directly affects the measurement at 100 k  $\Omega$ . It has negligible effect at 0  $\Omega$  and 10 k  $\Omega$  with greater effect the more the resistance deviates from 0  $\Omega$  or 10 k  $\Omega$ . Each of the parameters has positive effect at their primary resistances: increasing the value of the parameter increases the measured resistance. The default and theoretically normal value for each is 0.

### 11.4.2 Front-Panel Access

The calibration parameters 0\_ADJ, 10K\_ADJ, and 100K\_ADJ can be adjusted to optimize the accuracy. They can be accessed from the front panel of the 1560 using the **CAL DEVICE** function in the **MODULE** soft-key menu (see Section 5.4.3). Select the THRS device. A window appears showing the calibration parameters for the device.

**CALIBRATE DEVICE: THRS**



0 ADJ: 0.0

10K ADJ: 0.0

100K ADJ: 0.0

CAL DATE: 09-21-95

SER NUM: A32123

For the 2564 Thermistor Scanner Module the list of parameters includes 0\_ADJ, 10K\_ADJ, and 100K\_ADJ as described above. The list also includes the calibration date (CAL DATE) parameter, used to record the date the module was calibrated, and the serial number parameter (SER NUM), used to record the serial number of the module. New values can be entered for the parameters using the numeric buttons and pressing **ENTER**. The   buttons can be used to move between parameters.

### 11.4.3 Calibration Procedure

Calibration requires adjustment of the 0\_ADJ, 10K\_ADJ, and 100\_ADJ parameters at three specific input resistances. If the resistances used are approximately 0  $\Omega$ , 10 k  $\Omega$  and 100 k  $\Omega$  respectively the adjustments are independent and the procedure is simple. The order in which the adjustments are performed is important. The adjustment of the 100K\_ADJ parameter must be done last as the adjustments of 0\_ADJ and 10K\_ADJ affect the measurement at 100 k  $\Omega$  but 100K\_ADJ does not affect the measurements at 0  $\Omega$  or 10 k  $\Omega$ . Any channel can be used for calibration. Set the conversion type to R(  $\Omega$  ) to display resistance (see Sec. 4.2.1.1). The accuracy required of the resistance standards is 1/4 of the instrument accuracy; that is 0.05  $\Omega$  at 0  $\Omega$ , 0.25  $\Omega$  (25 ppm) at 10 k  $\Omega$ , and 2.5  $\Omega$  (25 ppm) at 100 k  $\Omega$ . The recommended procedure is as follows:

1. Connect a 0  $\Omega$  resistor to the input and measure its resistance. If a shorting wire is used the wire should run from pin 3 from the left to pin 4 to pin 5 then back across to pin 2. Note the average error in the measurement. Adjust the 0\_ADJ parameter by subtracting the measured error. For example, if the input is exactly 0.0  $\Omega$  and readout shows -0.11  $\Omega$ , 0\_ADJ should be adjusted by adding 0.11 to it.
2. Connect a 10 k  $\Omega$  resistor (25 ppm accuracy) to the input and measure its resistance. Note the average error in the measurement. Adjust the 10K\_ADJ parameter by subtracting the measured error. For example, if the input is exactly 10.00000 k  $\Omega$  and the readout shows 10.00295 k  $\Omega$ , 10K\_ADJ should be adjusted by subtracting 2.95 from it.
3. Connect a 100 k  $\Omega$  resistor (25 ppm accuracy) to the input and measure its resistance. Note the average error in the measurement. Adjust the 100K\_ADJ parameter by subtracting the measured error. For example, if the input is exactly 100.0000 k  $\Omega$  and the readout shows 99.9913 k  $\Omega$ , 100K\_ADJ should be adjusted by adding 8.7 to it.
4. Record the date with the calibration date parameter.
5. Verify the accuracy at 0  $\Omega$ , 4k  $\Omega$ , 10k  $\Omega$ , 40k  $\Omega$ , 100k  $\Omega$ , and 1M  $\Omega$ . Verify at least one resistance on each channel. The accuracy must be within the short-term accuracy given in the specifications.
6. Set the wiring configuration of both rows to three-wire (see Section 11.3.1). Verify the accuracy with at least one resistance on each channel. The accuracy must be within the short-term accuracy given in the specifications.



# Chapter 12

## 2565 Precision Thermocouple Module

### Note

*An Application Note for use of Tungsten-Rhenium and other thermocouples is available at [www.flukecalibration.com](http://www.flukecalibration.com).*

This section explains the features and operation of the optional 2565 Precision Thermocouple Module.

### **12.1 Description**

The 2565 Precision Thermocouple Module is an add-on module that allows the 1560 to measure temperature with extreme accuracy using thermocouples. Two thermocouples can be connected to the 2565 simultaneously and measured alternately. The module's unique clamping receptacles accept thermocouples terminated with either bare wires or subminiature thermocouple plugs. Sensors inside the receptacles measure temperature for precise automatic cold-junction compensation. For even greater accuracy, the 2565 also allows you to use an external cold-junction reference.

## 12.2 Specifications

<b>Voltage range</b>	0 to 100 mV
<b>Voltage accuracy, one-year<sup>1</sup></b> 0 to 50 mV 50 to 100 mV	0.002 mV 40 ppm of reading
<b>Voltage accuracy, short-term<sup>1,2</sup></b> 0 to 50 mV 50 to 100 mV	0.0015 mV 30 ppm of reading
<b>Internal CJC accuracy<sup>1</sup></b>	0.05 °C (0.09 °F)
<b>Temperature accuracy, external CJC<sup>1,3</sup></b> Type E @ 800 °C Type J @ 1000 °C Type K @ 1200 °C Type N @ 1200 °C Type S @ 1400 °C Type T @ 300 °C Type Au/Pt @ 1000 °C	±0.025 °C (0.045 °F) ±0.039 °C (0.070 °F) ±0.055 °C (0.10 °F) ±0.054 °C (0.098 °F) ±0.17 °C (0.31 °F) ±0.035 °C (0.063 °F) ±0.078 °C (0.14 °F)
<b>Temperature accuracy, internal CJC<sup>1,3</sup></b> Type E @ 800 °C Type J @ 1000 °C Type K @ 1200 °C Type N @ 1200 °C Type S @ 1400 °C Type T @ 300 °C Type Au/Pt @ 1000 °C	±0.065 °C (0.12 °F) ±0.083 °C (0.15 °F) ±0.10 °C (0.18 °F) ±0.090 °C (0.16 °F) ±0.19 °C (0.35 °F) ±0.070 °C (0.13 °F) ±0.092 °C (0.17 °F)
<b>Voltage temperature coefficient<sup>1</sup></b>	5 ppm/ °C (2.8 ppm/ °F)
<b>Internal CJC temperature coefficient<sup>1</sup></b>	0.005 °C/ °C (0.005 °F/ °F)
<b>Sample time</b>	2 seconds
<b>Number of channels</b>	2
<b>Recommended operating temperature range<sup>1</sup></b>	18 to 28 °C (64 to 82 °F)
<b>Absolute operating temperature range</b>	5 to 35 °C (40 to 95 °F)
<b>Weight</b>	2.5 lbs.
<p><sup>1</sup> The accuracy specifications apply within the recommended operating temperature range. Accuracy limits are increased by a factor of the temperature coefficient outside this range.</p> <p><sup>2</sup> Short-term accuracy includes nonlinearity and noise uncertainties. It does not include long-term drift or calibration uncertainties.</p> <p><sup>3</sup> Temperature accuracies do not include sensor uncertainties. Accuracies using external CJC do not include cold-junction reference uncertainty.</p>	

### 12.2.1 Calculating Accuracy

The temperature accuracy specifications listed are derived from the voltage accuracy and CJC accuracy. The accuracy of a thermocouple readout device in terms of temperature depends on the slope of the voltage-temperature relationship (Seebeck coefficient) at the temperature of interest (which depends on the type of thermocouple and its temperature), the accuracy of the voltage measurement, the slope of the voltage-temperature relationship at the cold-junction temperature, and the accuracy of the cold-junction temperature according to the following equation:

$$u_1 = \frac{u_v}{S(t)} + \frac{S(t_{CJ})}{S(t)} U_{CJ}$$

For the 2565/2566 modules the voltage accuracy is specified. If internal CJC is used, its accuracy is also specified. If external CJC is used, it is up to the user to determine the accuracy of the cold-junction temperature. The temperature accuracies listed above for external CJC are assuming negligible cold-junction temperature error.

Here is an example of how temperature accuracy is calculated. Suppose we are measuring with a type T thermocouple at  $-20\text{ }^\circ\text{C}$  and using internal CJC. At  $-200\text{ }^\circ\text{C}$  a T thermocouple has a Seebeck coefficient of about  $0.016\text{ mV}/^\circ\text{C}$ , and at about  $25\text{ }^\circ\text{C}$  (the cold-junction temperature) the Seebeck coefficient is about  $0.041\text{ mV}/^\circ\text{C}$ . From the specifications, the voltage accuracy of the 2565 is  $0.002\text{ mV}$  (at the voltage we are measuring) and the CJC accuracy is  $0.05\text{ }^\circ\text{C}$ . Applying the above equation for this situation gives a temperature accuracy of  $0.253\text{ }^\circ\text{C}$ :

$$u_1 = \frac{0.002\text{ mV}}{0.016\frac{\text{mV}}{^\circ\text{C}}} + \frac{0.041\frac{\text{mV}}{^\circ\text{C}}}{0.016\frac{\text{mV}}{^\circ\text{C}}} 0.05^\circ\text{C} = 0.125^\circ\text{C} + 0.128^\circ\text{C} = 0.253^\circ\text{C}$$

It could be argued that the voltage errors and CJC errors are uncorrelated so the two errors should be combined using a root-sum-square calculations. However, for simplicity, in our calculations we have just added the two components. The Seebeck coefficients for various types of thermocouples at various temperatures can be found in the standard tables for thermocouples, such as NIST Mono-graph 175.

### 12.3 Operation

Using the 2565 Precision Thermocouple Module with the 1560 Black Stack is very simple. The following sections explain the steps for setting up and using the 2565 to measure with thermocouples. For instructions for installing the 2565 Precision Thermocouple Module onto the 1560 see Section 4.1.

### 12.3.1 Connecting a Thermocouple

The 2565 Precision Thermocouple Module accepts both bare wires and sub-miniature size thermocouple plugs. If a plug is used it must match the thermocouple type for the internal CJC to be accurate. For example, if you are using a type K thermocouple you must also use a type K plug.

Each receptacle has a cam lever next to it that opens and closes the receptacle as shown in Figure 18. Flipping the lever out opens the receptacle. While the receptacle is open insert the wires or plug. The positive terminal is to the left and the negative terminal is to the right. Push the lever back in to clamp the wires or plug. After attaching a thermocouple to the 2565 wait two minutes before measuring for best results. Some shift in the measurement may occur as temperature gradients settle.

The input channels are numbered from left to right as explained in Section 4.5.1 and Figure 7.

### 12.3.2 Selecting the Thermocouple Type

To display temperature accurately each channel of the 2565 must be programmed for the correct thermocouple type. This is done using the **EDIT PROBE** soft-key in the **PROBE** menu (see Section 5.2.1). For example, if you are using a type K thermocouple on Input 1 select the **EDIT PROBE** function in the **PROBE** menu, select input channel 1, and set the **CONVERSION** type to TC-K. The 1560 converts voltage to temperature according to the standard formulas given in *NIST Monograph 175* (see Section 5.2.1.10).

When calibrating thermocouples, or the 2565 module itself, it is often useful to display voltage instead of temperature. Voltage is displayed by setting the **CONVERSION** type to V (see Section 5.2.1.9).

### 12.3.3 Selecting the CJC Type

The 1560 and 2565 can operate with either internal or external cold-junction compensation (CJC). CJC is necessary because a thermocouple can only measure relative temperatures between its measuring junction and reference junction. In order to determine the absolute temperature, the temperature of the reference junction must be known. With internal CJC the temperature of the reference junction (where the thermocouple connects to the 2565) is measured automatically with an internal thermistor temperature sensor and used in the calculation of the absolute temperature of the thermocouple. This method is most convenient and is often used. However, it has limitations of accuracy. This is because it is difficult to place the sensor very close to the connectors and maintain a low thermal gradient between the sensor and connectors. With external CJC a reference junction is created externally and copper wires connect the reference junction to the 2565. The reference junction is placed in an ice bath or other temperature source that has a precisely known and stable temperature. This technique offers improved accuracy but is less convenient because of the more complicated connection scheme and the requirement of a precision temperature source.

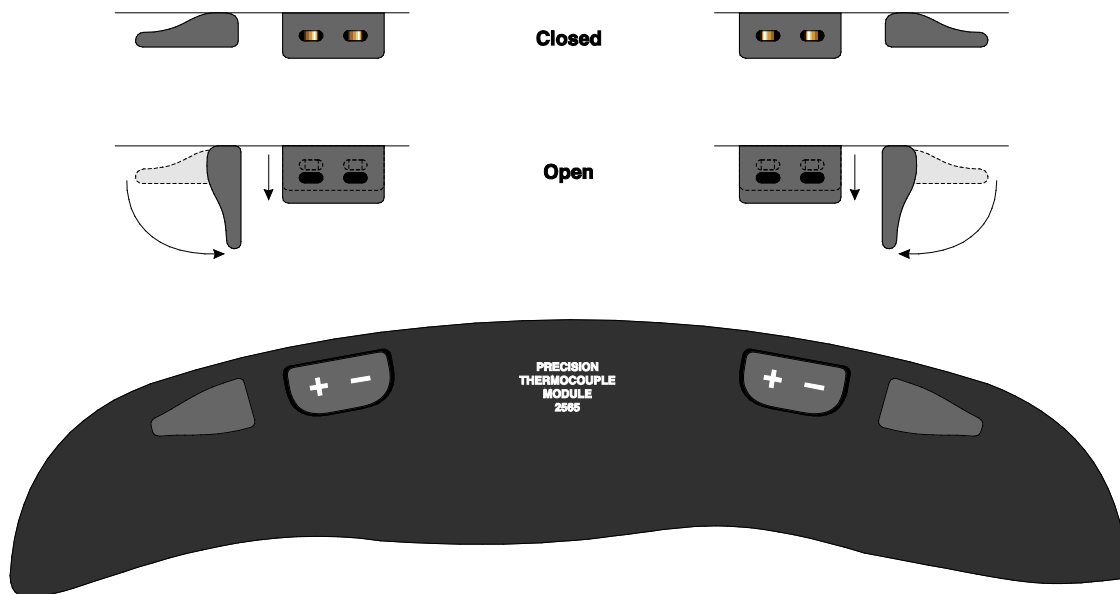

Figure 18. 2565 Module Thermocouple Receptacle Operation

The CJC type is selected using the **EDIT PROBE** function in the **PROBE** menu. Set the CJC parameter to INTERNAL (this is the default) for internal CJC. With internal CJC the CJC TEMP value is measured automatically so you do not need to enter a value. When using external CJC with an external temperature source and reference junction set CJC to EXTERNAL. You must also enter the temperature of the external reference junction for the CJC TEMP parameter. For instance, if the reference junction is placed in an ice bath set CJC TEMP to 0.0.

#### 12.3.4 Using Calibrated Thermocouples

The 1560 normally converts voltage to temperature according to the standard equations given in NIST Monograph 175. However, the actual voltage-temperature characteristics of a specific thermocouple may deviate from the standard equations. The 1560 can be programmed to adjust for this error. This requires that the thermocouple be calibrated so that its errors are known.

You can specify the adjustments in two ways. One is to specify temperature adjustments at several temperatures (see Section 5.2.1.10). For instance, if the thermocouple was calibrated and found to measure high by 0.06 °C at 500 °C you would enter -0.06 as the adjustment with 500 °C as the calibration temperature. You can specify adjustments for up to three calibration points. At temperatures between the calibration points a polynomial equation is used to estimate the required adjustment.

For types R, S, and gold-platinum thermocouples the adjustment can also be specified by coefficients of a second-order polynomial (see Section 5.2.1.10).

### 12.3.5 Suggestions for Optimum Accuracy

The sensitivity of thermocouple measurements, especially when using internal CJC, requires that the user take certain precautions to ensure accuracy.

#### 12.3.5.1 Warm-up Time

Measurements may change slightly as the 2565 module warms up after being powered on. For best accuracy allow the 2565 to warm up for one hour before making precision measurements.

#### 12.3.5.2 Ambient Environment

When using internal cold-junction compensation the connectors and internal sensors are sensitive to ambient temperature disturbances. The 2565 should be operated in a stable environment free from large and sudden ambient temperature variations. The 2565 will also be more accurate if the ambient temperature at which it is operated is close to the ambient temperature at which it was calibrated.

#### 12.3.5.3 Thermal Settling

When a thermocouple is plugged into the 2565 a certain amount of time is required before heat in the connector and receptacle becomes evenly distributed. For best results wait at least two minutes before making precision measurements.

#### 12.3.5.4 Ground Currents

The 2565 inputs are electrically isolated from all other components of the 1560 system and ground. This helps prevent ground loops that can produce noise and errors in the measurements. However, the two input channels are not isolated from each other. Errors can result if voltage potentials are imposed between the two thermocouples. Thus it is recommended that isolated thermocouple junctions be used whenever possible. If grounded thermocouples must be used then take precautions to ensure that potentials do not exist between the thermocouples.

### 12.3.6 Setup Parameters

The **SET UP DEVICE** function in the **MODULE** menu (see Section 5.4.2) allows access to two setup parameters.

GROUND allows you to internally connect the input circuit to ground by setting this option ON. This may help to reduce noise.

SAMP PER selects the sample period between 2 (normal) and 10 seconds. The purpose of this option is mainly for troubleshooting and it should not need to be accessed or changed during normal operation.

## 12.4 Calibration

This section explains the calibration procedure for the 2565 Precision Thermocouple Module.

### 12.4.1 Calibration Parameters

Eight adjustable parameters are used for calibration. They are listed in Table 28. The AMP GA parameter is set at the factory according to the type of amplifier installed. It should not need to be changed after initial calibration. If the voltage measurement is in error by a factor of nearly 2 the AMP GA parameter may be incorrect.

**Table 25. Precision Thermocouple Module calibration parameters**

Parameter	Description
AMP GA	Set to the nominal gain of the amplifier
OS 1	Adjusts the voltage accuracy of Input 1 at 0 mV OS
2	Adjusts the voltage accuracy of Input 2 at 0 mV GA
1	Adjusts the voltage accuracy of Input 1 at 100 mV
GA 2	Adjusts the voltage accuracy of Input 2 at 100 mV
CJ 1	Adjusts the internal CJC accuracy of Input 1
CJ 2	Adjusts the internal CJC accuracy of Input 2
CAL DATE	Records the date the module was calibrated

### 12.4.2 Front-Panel Access

The calibration parameters can be accessed from the front panel of the 1560 using the **CAL DEVICE** function in the **MODULE** soft-key menu (see Section 5.4.3.). Select the PTC device. A window appears showing the calibration parameters for the device.

<b>CALIBRATE DEVICE: TCS</b>	
<b>AMP GA: 1</b>	
<b>OS 1: 0.0007</b>	
<b>OS 2: 0.0005</b>	
<b>GA 1: -0.2138</b>	
<b>GA 2: -0.2134</b>	
<b>CJ 1: 0.273</b>	↓

New values can be entered for the parameters using the numeric buttons and pressing **ENTER**. The buttons can be used to move between parameters.

### 12.4.3 Calibration Procedure

Calibration is performed in two steps. First the voltage measurement is calibrated then the internal CJC is calibrated. The equipment required are a programmable voltage source, a precision voltmeter with an accuracy of 10 ppm or better, a thermocouple (preferably type E), and a temperature source between 0 and 30 °C. The combined accuracy of the reference thermocouple and temperature source must be 0.012 °C or better between the reference temperature and ambient temperature. At each step during the calibration procedure the readings should be allowed to settle for at least two minutes before recording the measurement. Also, the 2565 should be allowed to warm up for at least one hour after power up prior to calibration. The recommended procedure is as follows:

1. Connect the voltage source to Input 1, set it for 0 mV, and measure the voltage with the 1560 (using channel 1) and the voltmeter simultaneously. Adjust the OS 1 parameter by subtracting the measured error. For example, if the 1560 measures  $-0.0006$  mV, adjust the OS 1 parameter by adding 0.0006 to it. If it was previously 0.0000 it should now be 0.0006.
2. Connect the voltage source to Input 2, set it for 0 mV, and measure the voltage with the 1560 (using channel 2) and the voltmeter simultaneously. Adjust the OS 2 parameter by subtracting the measured error.
3. Connect the voltage source to Input 1, set it for 100 mV, and measure the voltage with the 1560 (using channel 1) and the voltmeter simultaneously. Adjust the GA 1 parameter by subtracting the measured error. For example, if the input is exactly 100.0000 mV and the 1560 shows 100.2953 mV, the GA 1 parameter should be adjusted by subtracting 0.2953 from it. If it was previously 0.0000 it should now be  $-0.2953$ .
4. Connect the voltage source to Input 2, set it for 100 mV, and measure the voltage with the 1560 (using channel 2) and the voltmeter simultaneously. Adjust the GA 2 parameter by subtracting the measured error.
5. Verify the voltage accuracy of both input channels at 0 and 50 mV. The accuracy must be within the short-term voltage accuracy given in the specifications.
6. Connect the calibrated thermocouple to Input 1 and insert the junction into the temperature source. Measure the temperature with the 2565 (use channel 1 and be sure to program the channel with the correct thermocouple type). Adjust the CJ 1 parameter by subtracting the measured error. For example, if the thermocouple temperature is actually  $0.0$  °C but the 1560 reads  $0.184$  °C, the CJ OS 1 parameter should be adjusted by subtracting 0.184 from it. If it was previously 0.000 it should now be  $-0.184$ .
7. Connect the calibrated thermocouple to Input 2. Measure the temperature with the 2565 (use channel 2 and be sure to program the channel with the correct thermocouple type). Adjust the CJ 2 parameter by subtracting the measured error.
8. Verify the temperature accuracy of both input channels using the calibrated thermocouple and temperature source. The accuracy should be within 75 % of the internal CJC accuracy given in the specifications.
9. Record the date with the CAL DATE parameter.



# Chapter 13

## 2566 Thermocouple Scanner Module

### Note

*An Application Note for use of Tungsten-Rhenium and other thermocouples is available at [www.flukecalibration.com](http://www.flukecalibration.com).*

This section explains the features and operation of the optional 2566 Thermocouple Scanner Module.

### 13.1 Description

The 2566 Thermocouple Scanner Module is an add-on module that allows the 1560 to measure temperature with up to 12 thermocouples simultaneously. It accepts nearly every type of thermocouple sensor. It incorporates built-in cold-junction compensation (CJC) for convenience. Alternately, external CJC can be used for greater accuracy. Up to 12 sensors can be connected to the 2566 simultaneously and measured alternately.

### 13.2 Specifications

<b>Voltage range</b>	0 to 100 mV
<b>Voltage accuracy, one-year<sup>1</sup></b> 0 to 50 mV 50 to 100 mV	0.004 mV 80 ppm of reading
<b>Voltage accuracy, short-term<sup>1,2</sup></b> 0 to 50 mV 50 to 100 mV	0.003 mV 60 ppm of reading
<b>Internal CJC accuracy<sup>1</sup></b>	0.2 °C (0.36 °F)
<b>Temperature accuracy, external CJC<sup>1,3</sup></b> Type E @ 800 °C Type J @ 1000 °C Type K @ 1200 °C Type N @ 1200 °C	±0.05 °C (0.09 °F) ±0.08 °C (0.14 °F) ±0.11 °C (0.20 °F) ±0.11 °C (0.20 °F)

Type S @ 1400 °C Type T @ 300 °C	±0.33 °C (0.60 °F) ±0.07 °C (0.13 °F)
Temperature accuracy, internal CJC <sup>1,3</sup> Type E @ 800 °C Type J @ 1000 °C Type K @ 1000 °C Type N @ 1000 °C Type S @ 1400 °C Type T @ 300 °C	±0.21 °C (0.38 °F) ±0.25 °C (0.46 °F) ±0.33 °C (0.60 °F) ±0.26 °C (0.47 °F) ±0.43 °C (0.78 °F) ±0.21 °C (0.38 °F)
Voltage temperature coefficient <sup>1</sup>	10 ppm/ °C (5.6 ppm/ °F)
Internal CJC temperature coefficient <sup>1</sup>	±0.03 °C/ °C ( ±0.03 °F/ °F)
Sample time	2 seconds
Number of channels	12
Recommended operating temperature <sup>1</sup>	18 to 28 °C (64 to 82 °F)
Absolute operating temperature range	5 to 35 °C (40 to 95 °F)
Weight	2.5 lbs.
<sup>1</sup> The accuracy specifications apply within the recommended operating temperature range. Accuracy limits are increased by a factor of the temperature coefficient outside this range. <sup>2</sup> Short-term accuracy includes nonlinearity and noise uncertainties. It does not include long-term drift or calibration uncertainties. <sup>3</sup> Temperature accuracies do not include sensor uncertainties. Accuracies using external CJC do not include reference junction temperature uncertainty.	

### 13.2.1 Calculating Accuracy

Please refer to Section 12.2.1 for a discussion on calculating temperature accuracies for thermocouple measurements.

## 13.3 Operation

Using the 2566 Thermocouple Scanner Module with the 1560 Black Stack is very simple. The following sections explain the steps for setting up and using the 2566 to measure with thermocouples. For instructions for installing the 2566 Thermocouple Scanner Module onto the 1560 see Section 4.1.

### 13.3.1 Connecting a Thermocouple

The 2566 Thermocouple Scanner Module accepts both standard and subminiature size thermocouple connectors. The connection is made with the positive terminal on the left and the negative terminal on the right. You must use a connector that matches the thermocouple type for the internal CJC to be accurate. For example, if you are using a type K thermocouple you must also use a type K connector which is made from the same type of metal. After inserting the thermocouple connector into the 2566, wait two minutes before measuring for best results.

The input channels are numbered from left to right and front to back as explained in Section 4.5.1 and Figure 7.

### 13.3.2 Selecting the Thermocouple Type

To display temperature accurately the 1560 must be programmed with the correct thermocouple type for each input channel. This is done using the **EDIT PROBE** soft-key in the **PROBE** menu (see Section 5.2.1). For example, if you are using a type **K** thermocouple on Input 3 select the **EDIT PROBE** function in the **PROBE** menu, select input channel 3, and set the **CONVERSION** type to **TC-K**. The 1560 converts voltage to temperature according to the standard formulas given in *NIST Monograph 175* (see Section 5.2.1.10).

When calibrating thermocouples or the 2566 module itself, it is often useful to display voltage instead of temperature. Voltage is displayed by setting the **CONVERSION** type to **V** (see Section 5.2.1.9).

### 13.3.3 Selecting the CJC Type

The 1560 allows for either internal or external CJC. CJC is necessary because thermocouples are only able to measure relative temperatures between the measuring junction and the reference junction. In order to determine the absolute temperature, the temperature of the reference junction must be known. With internal CJC the temperature of the reference junction, assumed to be the point where the thermocouple connects to the 2566, is measured using an internal thermistor temperature sensor. This method offers convenience and is most often used. However, it has limitations of accuracy. This is because it is difficult to place the sensor very close to the connectors and maintain a low thermal differential between the sensor and connectors. With external CJC a reference junction is created externally and copper wires connect the reference junction to the 2566. The reference junction is placed in an ice bath or other temperature source that has a precisely known and stable temperature. This technique offers improved accuracy but is less convenient because of the more complicated connection scheme and the requirement of a precision temperature source.

The 1560 allows the use of either internal or external CJC. Most applications will use internal CJC where the thermocouple probe is connected directly to the 2566. The CJC type is selected using the **EDIT PROBE** function in the **PROBE** menu. Set the CJC parameter to **INTERNAL** (this is the default). With internal CJC the CJC TEMP value is measured automatically and so you do not need to enter a value. When using external CJC with an external temperature source and reference junction set CJC to **EXTERNAL**. You must also enter the temperature of the external reference junction for the CJC TEMP parameter. For instance, if the reference junction is placed in an ice bath set CJC TEMP to 0.0.

### 13.3.4 Using Calibrated Thermocouples

The 1560 normally converts voltage to temperature according to the standard equations given in *NIST Monograph 175*. However, the actual voltage-temperature characteristics of thermocouples may deviate from the standard equations. For improved accuracy the 2566 can be programmed to make adjustments to the standard equations. This requires that the thermocouple be calibrated so that its errors are known.

You can specify the adjustments in two ways. One is to specify temperature adjustments at several temperatures (see Section 5.2.1.10). For instance, if the thermocouple was calibrated and found to measure high by 0.06 °C at 500 °C you would enter -0.06 as the adjustment with 500 °C as the calibration temperature. You can specify adjustments for up to three calibration points. At temperatures between the calibration points a polynomial equation is used to estimate the required adjustment.

For type R and S and gold-platinum thermocouples the adjustment can be specified by coefficients of a second-order polynomial (see Section 5.2.1.10).

### **13.3.5 Suggestions for Optimum Accuracy**

The sensitivity of thermocouple measurements, especially when using internal CJC, requires that the user take certain precautions to ensure accuracy as explained in the following sections.

#### **13.3.5.1 Warm-up Time**

Measurements may change slightly as the 2566 module warms up after being powered on. For best accuracy allow the 2566 to warm up for one hour before making precision measurements.

#### **13.3.5.2 Ambient Environment**

When using internal cold-junction compensation the connectors and internal sensors are sensitive to ambient temperature disturbances. The 2566 should be operated in a stable environment free from large and sudden ambient temperature variations. The 2566 will also be more accurate if the ambient temperature in which it is operated is close to the ambient temperature in which it was calibrated. Internal CJC is more accurate for the eight inputs near the center of the module. Use these channels for more precise measurements rather than the four inputs on the outside.

#### **13.3.5.3 Thermal Settling**

The process of removing and inserting thermocouple plugs into the 2566 produces temperature transients. This heat can cause a small error in the measurement for up to two to four minutes after the thermocouple is plugged in. For best results wait at least two minutes before making precision measurements.

### **13.3.6 Setup Parameters**

The SET UP DEVICE function in the MODULE menu (see Section 5.4.2) allows access to two setup parameters. SAMP PER selects the sample period between 2 (normal) and 10 seconds. POS shows the detected position of the module in the stack. The purpose of these options is mainly for troubleshooting and they should not need to be accessed or changed during normal operation.

## 13.4 Calibration

This section explains the calibration procedure for the 2566 Thermocouple Scanner Module.

### 13.4.1 Calibration Parameters

Eighteen adjustable parameters are used for calibration. They are listed in Table 29.

**Figure 26. Thermocouple Scanner Module calibration parameters**

Parameter	Description
AMP GA	Set to the nominal gain of the amplifier, type 1 or 2
OS 1	Adjusts the voltage accuracy of Inputs 1–6 at 0 mV
GA 1	Adjusts the voltage accuracy of Inputs 1–6 at 100 mV
CJ OS 1	Adjusts the internal CJC accuracy of Input 1
CJ OS 2	Adjusts the internal CJC accuracy of Input 2
CJ OS 3	Adjusts the internal CJC accuracy of Input 3
CJ OS 4	Adjusts the internal CJC accuracy of Input 4
CJ OS 5	Adjusts the internal CJC accuracy of Input 5
CJ OS 6	Adjusts the internal CJC accuracy of Input 6
OS 2	Adjusts the voltage accuracy of Inputs 7–12 at 0 mV
GA 2	Adjusts the voltage accuracy of Inputs 7–12 at 100 mV
CJ OS 7	Adjusts the voltage accuracy of Input 7
CJ OS 8	Adjusts the voltage accuracy of Input 8
CJ OS 9	Adjusts the voltage accuracy of Input 9
CJ OS 10	Adjusts the voltage accuracy of Input 10
CJ OS 11	Adjusts the voltage accuracy of Input 11
CJ OS 12	Adjusts the voltage accuracy of Input 12
CAL DATE	Records the date the module was calibrated

### 13.4.2 Front-Panel Access

The calibration parameters can be accessed from the front panel of the 1560 using the **CAL DEVICE** function in the **MODULE** soft-key menu (see Section 5.4.3). Select the TCS device. A window appears showing the calibration parameters for the device. The calibration parameters appear in two screens. The two screens appear alternately each time the device calibration window appears. The first screen contains the first nine parameters—AMP GA through CJ OS 6.

```
CALIBRATE DEVICE: TCS
AMP GA: 1
OS 1: 0.0006
GA 1: -0.257
CJ OS 1: -0.08
CJ OS 2: -0.11
CJ OS 3: -0.07 ↓
```

The second screen contains the parameters OS 2 through CJ OS 12 and also CAL DATE.

```
CALIBRATE DEVICE: TCS
OS 2: -0.0004
GA 2: -0.241
CJ OS 7: -0.05
CJ OS 8: 0.02
CJ OS 9: -0.10
CJ OS 10: -0.08 ↓
```

### 13.4.3 Calibration Procedure

Calibration is performed in two steps. The voltage measurement is calibrated first and then the internal CJC. Calibration is performed on sets of three channels at a time. The equipment required are a copper shorting plug, a programmable voltage source, a precision voltmeter with an accuracy of 20 ppm or better, a thermocouple (preferably type E) with a calibrated accuracy of 0.025 °C or better from 0 to 30 °C, and a temperature source between 0 and 30 °C with an accuracy of 0.025 °C. The AMP GA parameter is set at the factory according to the type of amplifier installed and should never be changed. At each step during the calibration procedure the readings should be allowed to settle for at least five minutes before recording the measurement. Also, the 2566 should be allowed to warm up for one hour after power up prior to calibration. The recommended procedure is as follows:

1. Connect the copper short to Input 2 (or any of inputs 1 through 6) and measure voltage. Adjust the OS 1 parameter by subtracting the measured error. For example, if the Black Stack measures  $-0.0013$  mV, adjust the OS 1 parameter by adding 0.0013 to it. This adjusts the offset for channels 1 through 6.
2. Connect the voltage source to Input 2, set it for 100 mV, and measure the voltage with the 1560 and the voltmeter simultaneously. Note the average error in the 2566 measurement. Adjust the GA 1 parameter by subtracting the measured error. For example, if the input is exactly 100.0000 mV and the 1560 shows 100.2953 mV, the GA 1 parameter should be adjusted by subtracting 0.2953 from it. This adjusts the gain for channels 1 through 6.
3. Repeat steps 1 and 2 for Input 8 (or any of inputs 7 through 12) adjusting the OS 2 and GA 2 parameters. This calibrates the voltage measurement of inputs 7 through 12.
4. Verify the voltage accuracy of each of the 12 input channels at 0 and 50 mV. The accuracy must be within the short-term voltage accuracy given in the specifications.
5. Connect the calibrated thermocouple to Input 1 and insert the measuring junction into the temperature source. Measure the temperature with the 2566 (be sure to program the 1560 with the correct thermocouple type). Note the average error in the 2566 measurement. Adjust the CJ OS 1 parameter by subtracting the measured error. For example, if the temperature measurement should be exactly  $0.0$  °C but the 1560 reads  $0.18$  °C, the CJ OS 1 parameter should be adjusted by subtracting 0.18 from it. This adjusts the CJC for Input 1.
6. Repeat step 5 for Inputs 2 through 12 adjusting CJ OS 2 through CJ OS12 respectively.
7. Verify the temperature accuracy of each of the 12 input channels using the calibrated thermocouple and temperature source. The accuracy should be within 75 % of the internal CJC accuracy given in the specifications.
8. Record the date with the CAL DATE parameter.





# Chapter 14

## **3560 Extended Communication Module**

This section explains the features and operation of the optional 3560 Extended Communication Module.

### **14.1 Description**

The 3560 is an add-on module that extends the communication capabilities of the 1560. First, it provides a GPIB (IEEE-488) interface. With this interface a system controller can remotely operate the 1560 and read measurements through an IEEE-488 bus. The Centronics printer interface allows the 1560 to connect to a printer. The 1560 can then be programmed to print out measurement data in real time. Measurements previously acquired and stored within the 1560 can also be printed. The 3560 also provides an analog output. This output sources a voltage that represents the value of measurements. The analog output can be connected to a strip-chart recorder for a graphical plot of temperature over time. Finally, the 3560 also adds a second RS-232 serial port. This can be used as a bi-directional communication interface or as a serial printer interface for the printing out of data.

### **14.2 Specifications**

See Table 30.

### **14.3 Installation**

The 3560 Extended Communication Module attaches to the back of the 1560 system as any other module. For instructions on installing modules onto the 1560 see Section 4.1. Since the 3560 Module has connectors placed on the back it must be installed as the last module in the stack.

Once the 3560 is installed onto the 1560 the 1560 will automatically recognize the Communication Module and the functions it provides. Five devices are added: the GPIB Communication Device (GPIB), Serial Communication Device (SERC), Serial Printer Device (SERP), Parallel Printer Device (PARP), and Analog Output Device (AOUT). These devices will appear labeled as indicated with the appropriate soft-key functions. The operation of each device is explained in the following sections.

## 14.4 GPIB Communication Device

The GPIB (IEEE-488) interface allows the 1560 to be connected to an IEEE-488 bus along with other instruments. A system controller can remotely control the operation of the 1560 and read measurements.

**Table 27. 3560 Specifications**

<b>GPIB (IEEE-488) interface</b>	
Capability	IEEE-488.2, 1992 SH1, complete source handshake capability AH1, complete acceptor handshake capability T6, basic talker, serial poll, no talk-only capability, unaddressed if MLA TE0, no extended-talk capability L4, basic listener, no listen-only capability, unaddressed if MTA LE0, no extended-listen capability SR1, complete serial poll capability RL0, no remote-local capability PP0, no parallel poll capability DC1, complete device clear capability DT0, no device trigger capability C0, no control capability E2, three-state drivers
<b>Parallel (Centronics) printer interface</b>	
Connector	25-pin subminiature D
<b>Serial (RS-232) interface</b>	
baud rate	1200 to 19200
Protocol	8 data bits, 1 stop bit, no parity
<b>Analog output</b>	
Number of channels	1
Connector	two-terminal screw clamp
Voltage range	-1.25 to +1.25V
Voltage resolution	0.0006V
Digital resolution	12 bits
Maximum source resistance	1 $\Omega$
Maximum output current	2 mA
Linearity	$\pm 0.0006V$
Typical accuracy <sup>†</sup>	$\pm 2\% \pm 0.02V$
Isolation	grounded
<b>Recommended operating temperature range</b>	18 to 28 °C (64 to 82 °F)
<b>Absolute operating temperature range</b>	5 to 35 °C (40 to 95 °F)
<b>Weight</b>	2.2 lbs. (1 kg.)
<sup>†</sup> Accuracy of the analog output can be significantly improved by calibration	

### 14.4.1 Capability

The 3560 GPIB interface conforms to standard IEEE-488.2, 1992. Its capabilities are identified as SH1, AH1, T6, L4, SR1, DC1, and E2. The interface has the capabilities of talk, listen, serial poll, and device clear. It has no capability for talk-only, listen-only, extended talk or listen, parallel poll, remote-local control, or trigger, nor can it act as controller. The IEEE-488 commands GET, GTL, LLO, and REN are accepted without error but ignored.

### 14.4.2 Connection

The IEEE-488 port is located on the back of the 3560 Module. Use a standard IEEE-488 cable to connect to your GPIB controller. A shielded cable should be used to prevent EM emissions.

### 14.4.3 Device Setup

The 1560 system must be set up to respond to the address the controller will use to communicate with it. The address is set using the **SET UP DEVICE** function in the **MODULE** soft-key menu (see Section 5.4.2). Select the GPIB device. A window appears showing the setup parameters for the device:

```
CALIBRATE DEVICE: TCS
OS 2: -0.0004
GA 2: -0.241
CJ OS 7: -0.05
CJ OS 8: 0.02
CJ OS 9: -0.10
CJ OS 10: -0.08 ↓
```

For the 3560 GPIB Communication Device the list of parameters includes address, line termination, and interface reset function. The default address is 22. The valid range is 1 to 30. The address will remain unchanged if an attempt is made to set the address outside this range. Use the numeric buttons to change the address, if necessary, and press **ENTER**. The new address will take effect immediately.

The **TERMINATION** parameter is used to set the line termination character for IEEE-488 communications. This should normally be set to LF which causes a linefeed character (ASCII 0A hex or 10 decimal) to be sent at the end of each line of transmission. If necessary, this can be changed to a carriage return character (ASCII 0D hexes or 13 decimal). The termination is changed using the **◀▶** buttons and pressing **ENTER**.

The **RESET** function can be used to reset the IEEE-488 interface and clear the input and output buffers. This is equivalent to executing the DCL or SDC IEEE-488 device clear commands. Use the **◀▶** buttons to change the option to YES then press **ENTER**.

#### **14.4.4 Commands**

The commands used for remote communications are explained in detail in Section 6. Commands are available to control nearly every function of the 1560. For example, the "ROUT:CLOS (@1)" command can be used to select input channel 1 for measurement. The "INIT:CONT ON" command can be used to initiate continuous measuring. The "FETC? (@1)" command can be used to read measurements from input channel 1.

#### **14.4.5 Serial Poll**

Serial poll can be used to alert the IEEE-488 controller whenever certain events occur such as completed measurement or communication error. Serial poll is enabled by setting the desired mask bits of the Service Request Enable Register (see Section 6.5.10.7). For instance, if the SRE register is set using the "\*SRE 128" command the 1560 will issue a service request whenever the Operation Status Bit (OSB) in the Status Byte Register is set (see Section 6.5.10.9). For summary bits in the Status Byte Register, such as the OSB, reporting must be enabled by setting certain mask bits in the appropriate status register. For instance, for the OSB to report a completed measurement, bit 4 of the Operation Status Enable Register must be set (see Sections 6.5.10.13 and 6.5.10.15).

When a service request is generated by the 1560 it sends the SRQ message to the IEEE-488 controller. The controller then reads the Status Byte Register from the 1560. (The meaning of each bit in the Status Byte Register is explained in Section 6.5.10.9.) Bit 6 of the status byte will be set if the 1560 caused the service request. Once the status byte is read the 1560 removes the SRQ message.

The IEEE-488 controller can use serial poll at any time to read the status byte from the 1560. Bit 6 of the status byte will be set if the 1560 is requesting service or 0 otherwise.

The Status Byte Register can also be polled using the "\*STB?" command (see Section 6.5.10.9).

#### **14.4.6 Device Clear**

The 3560 GPIB interface accepts both the DCL and SDC IEEE-488 commands to clear the device. These clear the input and output buffers.

### 14.4.7 Device Setup Commands

The SYST:MODn:DEVn:READ? and SYST: MODn:DEVn:WRIT commands (see Sections 6.5.8.19 and 6.5.8.20) can be used to read or set the setup parameters for the 3560 GPIB Communication Device. The device number of the GPIB Communication Device is 1. The module number for the 3560 module is its position in the stack. For example, if the 1560 has four add-on modules, the 3560 being the last, the module number for the 3560 is 4. Table 31 shows the device commands used to read or set the setup parameters of the GPIB Communication Device.

**Table 28. GPIB Communications Device Commands**

Device Command	Parameter	Description
LFEE	OFF or ON	linefeed
FFEE	YES	form feed

Below are some examples of using the device commands to set the device parameters. For these examples it is assumed that the 3560 Communication Module is placed fourth in the stack. These commands can be sent through any communication interface including the IEEE-488 and RS-232 interfaces.

SYST:MOD4:DEV4:WRIT "LFEE",OFF *Disable linefeed.*

SYST:MOD4:DEV4:READ? "LFEE" *Read the linefeed setting.*

SYST:MOD4:DEV4:WRIT "FFEE",YES *Send a form feed instruction.*

## 14.5 Serial Communication Device

The 3560 Extended Communication Module adds an additional RS-232 serial communications interface to the 1560 system. Connecting to the rear panel RS-232 port may be more convenient than connecting to the RS-232 port underneath the base.

### 14.5.1 Connection

The RS-232 port is located on the back of the 3560 Module. Wiring of the interface cable should be as shown in Figure 11 in Section 6.2. A shielded cable should be used to prevent EM emissions. The protocol for RS-232 communications is 8 data bits, 1 stop bit, and no parity.

### 14.5.2 Device Setup

The 3560 Serial Communication Device must be set up to use the same baud rate as the equipment with which it will be communicating. The baud rate is set using the **SET UP DEVICE** function in the **MODULE** soft-key menu (see Section 5.4.2). Select the SERC device. A window appears showing the setup parameters for the device:

```
SELECT A CHANNEL TO EDIT
-----
>SPRT 01, PROBE 566-011
  SPRT 02, PROBE 566-012
  TCS  03, PROBE 1341
  TCS  04, PROBE 1342
  TCS  05, PROBE 1343
  TCS  06, PROBE 1344      ↓
```

For the 3560 Serial Communication Device the list of parameters includes baud rate, duplex, and linefeed. Use the ◀▶ buttons to change the baud rate, if necessary, and press **ENTER**. Setting the baud rate here also sets the baud rate of the Serial Printer Device.

The DUPLEX parameter is used to set the duplex or echo mode of the RS-232 communications. Full duplex enables echo so that all characters received are echoed back to the computer. This is useful when using terminal emulation software. Half duplex disables echo. This is the usual mode when using control software on the computer. The duplex mode is changed using the ◀▶ buttons and pressing **ENTER**.

The LINEFEED parameter determines whether or not a linefeed character (ASCII 0A hex or 10 decimal) is sent at the end of each line of transmission in addition to a carriage return character (ASCII 0D hex or 13 decimal). Use the ◀▶ buttons to change the parameter then press **ENTER**.

### 14.5.3 Commands

The commands used for remote communications are explained in detail in Section 5. Commands are available to control nearly every function of the 1560. For example, the "ROUT:CLOS (@1)" command can be used to select input channel 1 for measurement. The "INIT:CONT ON" command can be used to initiate continuous measuring. The "FETC? (@1)" command can be used to read measurements from input channel 1.

### 14.5.4 Device Setup Commands

The SYST:MODn:DEVn:READ? and SYST: MODn:DEVn:WRIT commands (see Sections 6.5.8.19 and 6.5.8.20) can be used to read or set the setup parameters for the 3560 Serial Communication Device. The device number of the Serial Communication Device is 2. The module number for the 3560 module is its position in the stack. For example, if the 1560 has four add-on modules, the 3560 being the last, the module number for the 3560 is 4. Table 32 shows the device commands used to read or set the setup parameters of the Serial Communication Device.

Table 29. Serial Communication Device Commands

Device Command	Parameter	Description
BAUD	1200, 2400, 9600, 14400, or 19200	baud rate
DUPL	HALF or FULL	duplex mode
LFEE	OFF or ON	linefeed

Below are some examples of using the device commands to set the device setup parameters. For these examples it is assumed that the 3560 Communication Module is placed fourth in the stack. These commands can be sent through any communication interface including the IEEE-488 and RS-232 interfaces.

SYST:MOD4:DEV2:WRIT "BAUD",9600 Set the baud rate to 9600.

SYST:MOD4:DEV2:WRIT "DUPL",HALF Set the duplex mode to half duplex (echo off).

SYST:MOD4:DEV2:READ? "DUPL" Read the duplex mode.

SYST:MOD4:DEV2:WRIT "LFEE",OFF Disable linefeed.



## 14.6 Serial Printer Device



The RS-232 port of the 3560 can be used as either a communications interface or a printer interface. This section explains the operation of the 3560 Serial Printer Device. The Serial Printer Device can be used to print data to a printer or terminal equipped with an RS-232 serial interface. For connection of the RS-232 interface refer to Section 14.5.1 above.

### 14.6.1 Device Setup





The setup parameters for the 3560 Serial Printer Device include baud rate and linefeed. The baud rate must be set the same as the baud rate of the printer or terminal. The parameters are set using the **SET UP DEVICE** function in the **MODULE** soft-key menu (see Section 5.4.2). Select the SERP device. A window appears showing the setup parameters for the device:



```
EDIT SPRT 01
PROBE SER#: 566-011
CONVERSION: ITS-90
LO RANGE: 4
HI RANGE: 7
R[273]: 25.546738
A[4]: -1.5763669E-4
```

Use the   buttons to change the baud rate, if necessary, and press **ENTER**. Setting the baud rate here also sets the baud rate of the Serial Communication Device.

The LINEFEED parameter determines whether or not a linefeed character (ASCII 0A hex or 10 decimal) is sent at the end of each line of transmission in addition to a carriage return character (ASCII 0D hex or 13 decimal). Use the   buttons to change the parameter then press **ENTER**.

#### 14.6.2 *Printing Measurement Data*

The 1560 can be programmed to print out measurement data in real time. The printing of measurements is enabled using **the PRINT OUTPUT** function in the **OUTPUT** soft-key menu (see Section 5.3.3). A window will show a list of printer devices. Move to the SERP device using the   buttons. Change the option to ON using the   buttons. The 1560 will immediately begin printing all new measurements to the printer or terminal connected to the RS-232 port of the Communication Module.

The 1560 can also print out previously-acquired measurement data. This is done using the **PRINT MEMORY** function in the **OUTPUT** soft-key menu (see Section 5.3.4). A window will show a list of printer devices. Select the Serial Printer Device by moving to the SERP device using the   buttons and pressing **ENTER**. Now, enter the number of measurements to print using the numeric buttons and pressing **ENTER**. Press **ENTER** again to confirm. The number of measurements you specified, if available, will be retrieved from memory and printed to the printer or terminal connected to the RS-232 port of the Communication Module.

#### 14.6.3 *Device Setup Commands*

The SYST:MODn:DEVn:READ? and SYST: MODn:DEVn:WRIT commands (see Sections 6.5.8.19 and 6.5.8.20) can be used to read or set the setup parameters for the 3560 Serial Printer Device as explained in Section 14.5.4 above.



The device number of the Serial Printer Device is 3. Table 33 shows the device commands used to read or set the setup parameters of the Serial Printer Device.

**Table 30. Serial Printer Device Commands**

Device Command	Parameter	Description
BAUD	1200, 2400, 9600, 14400, or 19200	baud rate
LFEE	OFF or ON	linefeed

## 14.7 Parallel Printer Device

The Centronics parallel port of the 3560 can be used to connect the 1560 to a standard printer. The printer can be used to print out measurement data.

### 14.7.1 Connection

The parallel printer port is located on the back of the 3560 Module. Use a standard Centronics parallel printer cable to connect to your printer. A shielded cable should be used to prevent EM emissions.

### 14.7.2 Device Setup

The setup parameters for the 3560 Parallel Printer Device include linefeed and form feed. The parameters are set using the **SET UP DEVICE** function in the **MODULE** soft-key menu (see Section 5.4.2). Select the PARP device. A window appears showing the setup parameters for the Serial Printer Device:

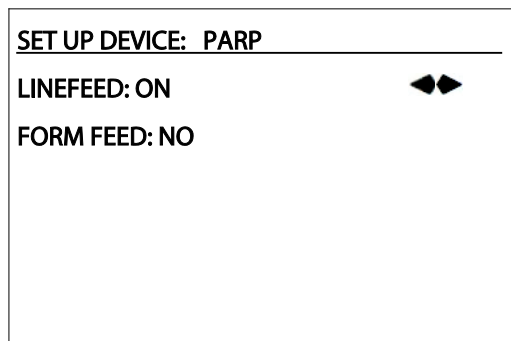

The LINEFEED parameter determines whether or not a linefeed character (ASCII 0A hex or 10 decimal) is sent at the end of each line of transmission in addition to a carriage return character (ASCII 0D hex or 13 decimal). Use the ◀▶ buttons to change the parameter then press **ENTER**.

The FORM FEED parameter can be used to eject a partially-printed page of paper. Use the ◀▶ buttons to change the parameter to YES then press **ENTER**.

### 14.7.3 Printing Measurement Data

The 1560 can be programmed to print out measurement data in real time. The printing of measurements is enabled using the **PRINT OUTPUT** function in the **OUTPUT** soft-key menu (see Section 5.3.3). A window will show a list of printer devices. Move to the PARP device using the **▲▼** buttons. Change the option to ON using the **◀▶** buttons. The 1560 will immediately begin printing all new measurements to the printer or terminal connected to the parallel printer port of the Communication Module.

The 1560 can also print previously-acquired measurement data. This is done using the **PRINT MEMORY** function in the **OUTPUT** soft-key menu (see Section 5.3.4). A window will show a list of printer devices. Select the Parallel Printer Device by moving to the PARP device using the **▲▼** buttons and pressing **ENTER**. Now, enter the number of measurements to print using the numeric buttons and pressing **ENTER**. Press **ENTER** again to confirm. The number of measurements you specified, if available, will be retrieved from memory and printed to the printer or terminal connected to the parallel printer port of the Communication Module.

### 14.7.4 Device Setup Commands

The SYST:MODn:DEVn:READ? and SYST: MODn:DEVn:WRIT commands (see Sections 6.5.8.19 and 6.5.8.20) can be used to read or set the setup parameters for the 3560 Parallel Printer Device. The device number of the Parallel Printer Device is 4. The module number for the 3560 module is its position in the stack. For example, if the 1560 has four add-on modules, the 3560 being the last, the module number for the 3560 is 4. Table 34 shows the device commands used to read or set the setup parameters of the Parallel Printer Device.

Table 31. Parallel Printer Device Commands

Device Command	Parameter	Description
LFEE	OFF or ON	linefeed
FFEE	YES	form feed

Below are some examples of using the device commands to set the device parameters. For these examples it is assumed that the 3560 Communication Module is placed fourth in the stack. These commands can be sent through any communication interface including the IEEE-488 and RS-232 interfaces.

SYST:MOD4:DEV4:WRIT "LFEE",OFF Disable linefeed.

SYST:MOD4:DEV4:READ? "LFEE" Read the linefeed setting.

SYST:MOD4:DEV4:WRIT "FFEE",YES Send a form feed instruction.

## 14.8 Analog Output Device

The analog output port of the 3560 can be used to connect the 1560 to a strip-chart recorder, temperature controller, or other device that receives a voltage-encoded temperature signal. The analog output transmits a voltage that is a function of the measured temperature. The voltage can represent the measurement on any input channel or the difference between the measurements of any two input channels. It can represent resistance, temperature, or a statistical function of temperature. The analog output has a range of  $\pm 1.25\text{V}$ . The digital-to-analog conversion has a resolution of 12 bits or  $0.0006\text{V}$ . It can be calibrated for an accuracy of better than 2 mV.

### 14.8.1 Connection

The analog output port is located on the back of the 3560 Communication Module. The terminals are labeled '+' and '-'. The '-' terminal connects to ground. The '+' terminal carries an analog signal relative to ground. Insert wires with 1/2" of insulation removed into the terminals and clamp the terminals down using a small flat-blade screwdriver.

### 14.8.2 Device Setup



The setup parameters for the 3560 Analog Output Device include center and scale. The parameters are set using the **SET UP DEVICE** function in the **MODULE** soft-key menu (see Section 5.4.2). Select the AOUT device. A window appears showing the setup parameters for the device:

<b>SET UP DEVICE: AOUT</b>
<b>CENTER: 0.0</b>
<b>SCALE: 100.0</b>

The **CENTER** parameter determines the measurement value that produces 0V. For instance, if **CENTER** is 25.0 then a reading of 25.0 °C will cause the output voltage to be 0. Use the numeric buttons to set the **CENTER** parameter then press **ENTER**.

The **SCALE** parameter determines the measurement range that produces a 1V change in the output. For instance, if **CENTER** is 25.0 and **SCALE** is 100.0 then a reading of 0 °C causes a voltage of  $-0.25\text{V}$  to be output. Use the numeric buttons to set the **SCALE** parameter then press **ENTER**.

### 14.8.3 Selecting Data

The 1560 can be programmed to send any type of measurement from any channel to the analog output. This is done using the **OUTPUT CHAN** function in the **OUTPUT** soft-key menu (see Section 5.3.2). A window will show a list of output channels. Select the AOUT channel using the   buttons and pressing **ENTER**. Select the input channel you want to output using the +CHANNEL parameter. A window appears showing a list of input channels. Move to the desired channel and press **ENTER**. If you want to output the difference between two channels select a channel for the -CHANNEL in the same way, otherwise leave it 0. Next, select the calculation type. You can select between TEMP (temperature), INPUT (i.e. resistance), or various statistical functions of temperature. The analog output will immediately begin transmitting a DC voltage representing the specified measurement. The voltage will be offset and scaled based on the CENTER and SCALE setup parameters explained above. The output will be updated every time a new measurement is completed on either of the selected input channels.

### 14.8.4 Calibration

The 3560 Analog Output Device can be calibrated to improve accuracy. The calibration parameters are accessed using the **CAL DEVICE** function in the **MODULE** soft-key menu (see Section 5.4.3). Select the AOUT device. A window appears showing the calibration parameters for the Analog Output Device:

```
CALIBRATE DEVICE: AOUT
-----
0V ADJ: 0.0
1V ADJ: 0.0
CAL DATE: 09-21-95
```

The 0V\_ADJ parameter adjusts the accuracy at 0V. As an example, if the output is +0.013V when it should be exactly 0 then 0V\_ADJ should be adjusted by subtracting 0.013 from its present value. The error at 0V can be determined by measuring a known value, such as the resistance of a short, and then setting the CENTER setup parameter to that value. Set the SCALE parameter to a large value, such as 10000, for better accuracy. The output should then be exactly 0V.

The 1V\_ADJ parameter adjusts the accuracy at 1V. As an example, if the output is +0.991V when it should be exactly 1V then 1V\_ADJ should be adjusted by adding 0.009 to its present value. The error at 1V can be determined by measuring the resistance of a short and setting the SCALE setup parameter to a large value, such as 10000, and the CENTER parameter to the opposite of that value ( -10000). The output should be exactly 1V.

The CAL DATE parameter can be used to record the date the calibration was performed.

#### 14.8.5 Device Setup Commands

The SYST:MODn:DEVn:READ? and SYST: MODn:DEVn:WRIT commands (see Sections 6.5.8.19 and 6.5.8.20) can be used to read or set the setup parameters for the 3560 Analog Output Device. The device number of the Analog Output Device is 5. The module number for the 3560 module is its position in the stack. For example, if the 1560 has four add-on modules, the 3560 being the last, the module number for the 3560 is 4. Table 35 shows the device commands used to read or set the setup parameters of the Analog Output Device.

**Table 32. Analog Output Device Commands**

Device Command	Parameter	Description
CNTR	numeric	0V center
SCAL	numeric	1V scale

Below are some examples of using the device commands to set the device parameters. For these examples it is assumed that the 3560 Communication Module is placed fourth in the stack. These commands can be sent through any communication interface including the IEEE-488 and RS-232 interfaces.

SYST:MOD4:DEV5:WRIT "CNTR",25 *Set center of range at 25 °C.*

SYST:MOD4:DEV5:READ? "CNTR" *Read center setting.*

SYST:MOD4:DEV5:WRIT "SCAL",10 *Set scale to 10 °C/V.*



# **Chapter 15**

## ***Maintenance***

- The calibration instrument has been designed with the utmost care. Ease of operation and simplicity of maintenance have been a central theme in the product development. Therefore, with proper care the instrument should require very little maintenance. Avoid operating the instrument in an oily, wet, dirty, or dusty environment.
- If the outside of the instrument becomes soiled, it may be wiped clean with a damp cloth and mild detergent. Do not use harsh chemicals on the surface which may damage the paint or the plastic of the outside shell.
- If a hazardous material is spilt on or inside the equipment, the user is responsible for taking the appropriate decontamination steps as outlined by the national safety council with respect to the material.
- If the mains supply cord becomes damaged, replace it with a cord with the appropriate gauge wire for the current of the instrument. If there are any questions, call Hart Scientific Customer Service for more information.
- Before using any cleaning or decontamination method except those recommended by Hart, users should check with Hart Scientific Customer Service to be sure that the proposed method will not damage the equipment.
- If the instrument is used in a manner not in accordance with the equipment design, the operation of the thermometer may be impaired or safety hazards may arise.





# Chapter 16

## Troubleshooting

In case you run into difficulty while operating the 1560 system, this section provides some suggestions that may help you solve the problem. Below are several situations that may arise followed by possible causes of the problem and suggested actions you might take.

### 16.1 Incorrect Temperature Reading

While attempting to measure temperature the display shows an incorrect value or no value at all (“. . . . .”).

If the temperature readings seem to be incorrect you should first check to see if the resistance, or voltage in the case of thermocouples, is being measured correctly. Set up the display to show the resistance or voltage (INPUT) for the channel (see Section 5.3.1.2). If the resistance or voltage is incorrect refer to the next subsection for troubleshooting incorrect resistance or voltage readings. If the resistance or voltage is being measured correctly but the displayed temperature value is incorrect consider the following possibilities:

- **One or more coefficients are incorrect.** This is a common mistake. While entering coefficients it is easy to miss a digit or sign. Check all the values carefully using the **EDIT PROBE** function (see Section 5.2.1) comparing them with the values on the calibration certificate for the probe. Use the **TEST CONV** function to test the coefficients (see Section 5.2.3).
- The selected conversion type is incorrect. Check to make sure the correct conversion type is selected. In the case of thermocouples, make sure you have selected the correct thermocouple type. Again, you can use the **TEST CONV** function to test the temperature conversion calculation.
- The measurement is out of range. The 1560 may not be able to calculate temperature accurately if the resistance or voltage is outside the valid range. The measured resistance or voltage may be too low or too high if the actual temperature is too low or too high or if there is a problem with the sensor (see below).

## 16.2 Incorrect Resistance or Voltage Reading

While attempting to measure resistance or voltage the display shows an incorrect value or no value at all (“. . . . .”).

Consider the following possibilities:

- **Poor or incorrect connection of the probe.** A common mistake is to connect the wires of the probe to the wrong terminals. Check the wiring carefully, especially when using a four-wire PRT (see Figure 13 or Figure 15). Make sure the lead wires are fastened down tightly.
- **Open, shorted, or damaged sensor or lead wires.** In the case of resistance sensors check the resistance across the sensor using a hand-held DMM. Also check the resistance between common pairs of leads. Check to make sure there is no conductivity between any of the leads and the probe sheath. Use a good-quality sensor to avoid errors caused by drift, hysteresis, or insulation leakage. In the case of thermocouples, use a hand-held DMM to check its voltage.
- **Improper setting for three or four-wire probe.** When using the 2562 or 2564 scanner modules you need to make sure the correct wiring type is selected (read carefully Section 9.3.1 or 11.3.1). Selecting three-wire input while using four-wire probes may cause errors of 0.01 to 0.1  $\Omega$ . Selecting four-wire input while using three-wire probes will result in erratic or out-of-range readings.
- **Electrical interference.** Intense radio-frequency radiation near the 1560 or probes can induce noise into the measurement circuits resulting in erratic readings. The 1560 is intended to operate in a laboratory environment with limited radio-frequency noise. If interference seems to be a problem you might try eliminating the source of interference or moving the 1560 to a different location. A well-grounded, shielded cable should be used for the probe leads.
- **Stem conduction error.** The problem may be that the actual temperature of the sensor is not what you expect. This is often the result of stem conduction where heat flowing through the stem of the probe to ambient affects the temperature of the probe. It is very important that immersion probes be inserted to an adequately depth into the material being measured. Measuring temperature using a surface sensor can be especially difficult as the sensor is directly exposed to ambient.

## 16.3 Communication Difficulties

You are having trouble establishing communications between the 1560 and a remote computer using either the base RS-232 port, the 3560 Module RS-232 port, or the 3560 Module IEEE-488 port.

First, test RS-232 communications using the base serial port. Connect a serial cable to a computer running terminal software such as Windows ® 3.1 Terminal or Windows ® 95 HyperTerminal. Be sure to set the baud rates of both the 1560 and the computer to the same number. Use 8 data bits, 1 stop bit, and no parity. Test transmission from the 1560 by enabling the PRINT OUTPUT function for the SER0 device. You should see measurement data appear on the computer. Test reception by sending a command to the 1560 such as "UNIT:TEMP F" or "UNIT:TEMP C". You should see the units of the measurement change accordingly. Be sure to use a space character to separate the header from the parameter in this and other commands.

Repeat the same tests with the RS-232 port on the 3560 module. Test the transmission of measurement data and the reception of commands.

Debugging IEEE-488 communications can be more difficult since it is so much more complex. The 3560 Module has a diagnostic mode that can help in troubleshooting communication problems. Issuing the command "\*DIA" to the 3560 Module RS-232 port enables the diagnostic mode. Diagnostic information will be printed from the 3560 Module RS-232 port and can be viewed on your computer. You will be able to see how commands are received at the IEEE-488 port and monitor the value of the IEEE-488 status byte register (see Section 6.5.10.9). If the IEEE-488 port does not seem to be receiving any data check that the GPIB addresses are correct (see Section 14.4.3). Also check the cable. If commands are being received but your computer is not receiving any data from the 1560 in response to the command check that the termination character is set correctly (also Section 14.4.3). Setup your software so that it does not require the EOI message.

## **16.4 Blank Screen**

The screen lights up when the 1560 is switched on but the screen appears blank. This problem can be caused by improper adjustment of the contrast. After the power is switched on allow the 1560 at least one minute to complete its self-test and power on sequence. Then, try to adjust the contrast using the contrast buttons.

## **16.5 Error Message at Power Up**

The 1560 reports an error during the power up self-test.

On power up the 1560 performs a series of self-tests to check the operation of all its components and each of the modules. The results of the self-tests are reported on the screen. Normally, all tests will report "OK." A failure of one or more component will cause error messages to be reported. A bus error, a module error, a failure to recognize a module, or a "BATTERY BACKED RAM" error is often caused by a module being improperly attached in which case the base will not be able to properly communicate with that module and those behind it. Try reattaching the module while ensuring that the bus connectors are all fully inserted. If this does not solve the problem it may be caused by a damaged module or the failure of a component within the module such as the fuse. This and other types of component failures generally require a qualified factory technician to replace the faulty component. Contact a Hart Scientific Authorized Service Center for assistance (see Section 1.3).

## **16.6 CE Comments**

### **16.6.1 EMC Directive**

Hart Scientific's equipment has been tested to meet the European Electromagnetic Compatibility Directive (EMC Directive, 2004/108/EC). The Declaration of Conformity for your instrument lists the specific standards to which the unit was tested.

The instrument was designed specifically as a test and measuring device. Compliance to the EMC directive is through EN 61326-1:2006 Electrical equipment for measurement, control and laboratory use - EMC requirements

As noted in the EN 61326-1, the instrument can have varying configurations. The instrument was tested in a typical configuration with shielded RS-232 cables.

#### **16.6.1.1 Immunity Testing**

The instrument was tested to the requirements for industrial locations. This allows the instrument to be used in all types of locations from the laboratory to the factory floor. Criterion A, B, or C was used for Radiated RF (IEC 61000-4-3) depending on the module configuration. Criterion A or B was used for Conducted RF (IEC 61000-4-6) depending on the module configuration. Therefore, the operation of the instrument may be affected by excessive electromagnetic interference and the instrument may not perform within the normal specification limits in such an environment.

Criterion A or C was used for Electrostatic Discharge (ESD, IEC 61000-4-2) depending on the module configuration. Criterion A or B was used for Electric Fast Transit (EFT, Burst, IEC 61000-4-4) depending on the module configuration. If the instrument is subjected to ESD conditions at industrial levels, the instrument may require the user to cycle the power to return to normal operation.

#### **16.6.1.2 Emission Testing**

The instrument fulfills the limit requirements for Class A equipment but does not fulfill the limit requirements for Class B equipment. The instrument was not designed to be used in domestic establishments.

### **16.6.2 Low Voltage Directive (Safety)**

In order to comply with the European Low Voltage Directive (73/23/EEC), Hart Scientific equipment has been designed to meet the IEC 1010-1 (EN 61010-1) and the IEC 1010-2-010 (EN 61010-2-010) standards.