

CHEMISTRY PUMPING UNIT SERIES

PC 510 select
PC 511 select
PC 520 select
PC 610 select
PC 611 select
PC 620 select



Instructions for use



Original instructions**Keep for future use!**

This document may only be used and distributed in its complete and original form. It is the user's responsibility to ensure the validity of this document with respect to the product.

Manufacturer:

VACUUBRAND GMBH + CO KG

Alfred-Zippe-Str. 4

97877 Wertheim

GERMANY

Head office: +49 9342 808-0

Sales: +49 9342 808-5550

Service: +49 9342 808-5660

Fax: +49 9342 808-5555

E-mail: info@vacuubrand.com

Web: www.vacuubrand.com

*Thank you for purchasing this product from **VACUUBRAND GMBH + CO KG**. You have chosen a state-of-the-art, high-quality product.*

TABLE OF CONTENTS

1	About this manual	6
1.1	User information	6
1.2	Instruction manual layout	7
1.3	Presentation conventions.....	8
1.4	Symbols and pictograms	9
1.5	Action instructions	10
1.6	Abbreviations	11
1.7	Explanation of terms.....	12
2	Safety instructions	14
2.1	Use	14
2.1.1	Proper use.....	14
2.1.2	Improper use	15
2.1.3	Foreseeable misuse.....	15
2.2	Responsibilities	16
2.3	Target group description	17
2.4	General safety information.....	18
2.5	Protective clothing.....	18
2.6	Safety measures	18
2.7	Laboratory and work materials.....	19
2.8	Possible sources of danger	20
2.9	Motor protection	22
2.10	ATEX device category	23
2.11	Disposal	24
2.12	ATEX device category	24
3	Product description	26
3.1	Basic configuration of pumping unit series.....	26
3.2	Chemistry pumping unit series	28
3.3	Condensers and coolers	29
3.3.1	Separator/condenser at inlet	29
3.3.2	Condenser at outlet.....	29
3.4	Application example	30
4	Installation and connection	32
4.1	Transport	32
4.2	Installation.....	33
4.3	Connection (supply connections)	35

4.3.1	Vacuum connection (IN).....	35
4.3.2	Exhaust connection (OUT)	37
4.3.3	Coolant connection on the condenser.....	38
4.3.4	Venting connection	39
4.3.5	Gas ballast (GB)	41
4.4	Electrical connection	42
5	Operation	45
5.1	Switching on.....	45
5.2	Operation with controller	46
5.2.1	Operator interface.....	46
5.2.2	User interface PC 520 or PC 620.....	47
5.2.3	Operation.....	50
5.2.4	Operation with gas ballast.....	51
5.3	Switching off (decommissioning).....	53
5.4	Storage.....	54
6	Troubleshooting	55
6.1	Technical assistance	55
6.2	Error – cause – corrective measure	55
7	Cleaning and maintenance	58
7.1	Information on service activities.....	59
7.2	Cleaning.....	61
7.2.1	Housing surface.....	61
7.2.2	Emptying the glass flask	62
7.2.3	Cleaning or replacing PTFE molded hoses.....	62
7.3	Vacuum pump maintenance	63
7.3.1	Maintenance items	63
7.3.2	Changing the membranes and valves.....	65
7.3.3	Replacing a device fuse.....	76
8	Annex	78
8.1	Technical data.....	78
8.2	Wetted materials.....	81
8.3	Rating plate	82
8.4	Order data.....	83
8.5	Service information.....	85
8.6	EU declaration of conformity	86
8.7	UKCA conformity declaration	87

1 About this manual

This User manual is part of the product you have purchased.

This instruction manual is valid for all pumping unit models, together with the instruction manual of the **VACUU SELECT** controller, and is intended specifically for operators.

1.1 User information

Safety

Instruction manual
and safety

- Read the User manual carefully before using the product.
- Store the User manual in a place where it is accessible and close at hand at all times.
- Correct use of the product is essential for safe operation. Above all else, please follow the safety instructions!
- In addition to the information in this User manual, please also observe the applicable national regulations on accident prevention and occupational safety.

General

General information

- When passing this product on to third parties, please also include the User manual.
- All figures and drawings are examples and are solely intended for the purpose of better understanding.
- We reserve the right to make technical changes in the course of continuous product improvement.
- In the interest of readability, the Pumping unit is equally used in place of the product name Chemistry pumping unit PC 5xx select.

Copyright

Copyright® and
copyright law

The content of this User manual is protected by copyright law. Copies for internal purposes are permitted, e.g. for trainings. © **VACUUBRAND GMBH + CO KG**

Contact

Please contact us

- In case of an incomplete User manual, you can request a replacement from us. Alternatively, our download portal is available to you: www.vacuubrand.com
- Call us or write to us if you have any other questions about the product, need additional information or want to give us feedback on the product.
- When you contact our service department, please have the serial number and product type on hand --> see the nameplate on the product.

1.2 Instruction manual layout

Manual organization

The instruction manual for the pumping unit, the controller and available accessories is organized in a modular format; this means that the instructions are divided into individual, separate instruction brochures.

Instruction modules

Pumping unit series and modular instruction manuals

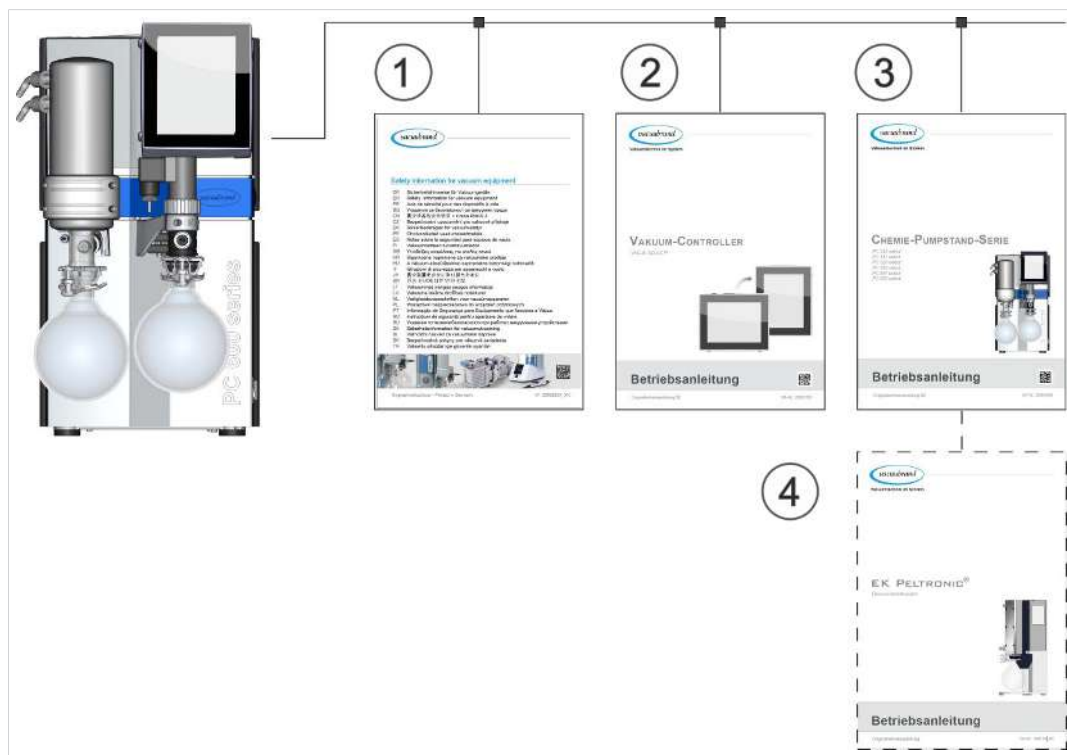

Meaning

- 1** Safety instructions for vacuums
- 2** Instruction manual: Vacuum controller – Control and operation
- 3** Instruction manual: Pumping unit – Connection, operation, maintenance, mechanical system

4 Optional instruction manual: Accessories

1.3 Presentation conventions

Warning messages

Presentation of warning messages

	DANGER
	<p>Warning of imminent danger.</p> <p>Failure to observe this warning may result in imminent danger to life or severe injury.</p> <ul style="list-style-type: none"> ➤ Please follow the instructions for prevention!

	WARNING
	<p>Warning of a potentially dangerous situation.</p> <p>Failure to observe this warning may result in danger to life or serious injury.</p> <ul style="list-style-type: none"> ➤ Please follow the instructions for prevention!

	CAUTION
	<p>Indicates a potentially dangerous situation.</p> <p>Failure to observe this caution may result in minor injuries or material damage.</p> <ul style="list-style-type: none"> ➤ Please follow the instructions for prevention!

NOTICE	
<p>Reference to a potentially harmful situation.</p> <p>Failure to observe this note may result in material damage.</p>	

Additional information

Presentation of information and tips

	<p>General information about:</p> <ul style="list-style-type: none"> ⇒ Tips and tricks ⇒ Helpful functions or activities
---	---

1.4 Symbols and pictograms

This instruction manual uses symbols and pictograms. These safety symbols and pictograms indicate specific dangers or requirements when handling the product. Warning signs with safety symbols on the product provide a visualization of the potential hazard.









Safety symbols

Explanation of safety symbols

	General danger sign.		Warning of electrical voltage.
	Warning of hot surface.		Electrostatically sensitive components ESD.
	General mandatory action sign.		Disconnect power plug from electrical outlet.

Other symbols and pictograms

Additional symbols

	Positive example – Right! Result – o.k.		Negative example – Wrong!
	Reference to content in this User manual.		Reference to content in supplementary documents.
	Ensure sufficient air circulation.		
	Electrical and electronic equipment and batteries must not be disposed of in household waste at the end of their service life.		
	Inlet current arrow – vacuum connection		
	Outlet current arrow – exhaust gas		

1.5 Action instructions

Action instructions (simple)

- Action instructions
- ⇒ You are requested to take action.
 - Result of the action

Action instructions (multiple steps)

1. First action step
 2. Next action step
- Result of the action

Action instructions that require several steps must be followed in the order they are described.

Action instructions (image description)

-> Example
Principle presentation
Operating steps
presented in images

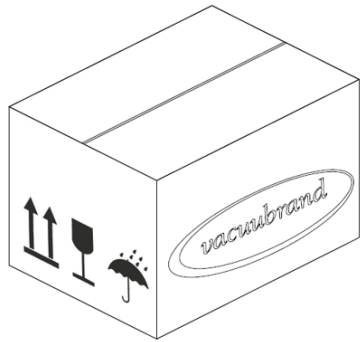
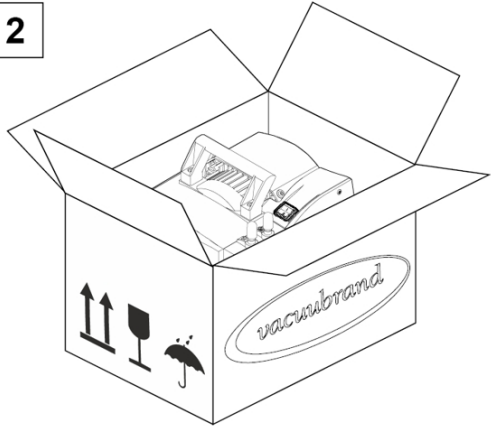
<div data-bbox="438 963 502 1025" style="border: 1px solid black; padding: 2px; width: 30px; margin: 0 auto;">1</div> 	<div data-bbox="981 963 1045 1025" style="border: 1px solid black; padding: 2px; width: 30px; margin: 0 auto;">2</div> 
<p>1. First action step.</p>	<p>2. Next action step.</p> <ul style="list-style-type: none"> <input checked="" type="checkbox"/> Interim result or result of the action

1.6 Abbreviations

Abbreviations used

>/	No greater than
abs.	Absolute
AK	Separator flask
ATM	Atmospheric pressure (bar graph, program)
di	Diameter
DN	Diameter nominal
EK	Emission condenser
EKP	Peltronic emission condenser or Peltronic EK
EX ¹	Outlet (exhaust, exit), exhaust gas connection
	ATEX device marking
FPM	Fluoropolymer rubber
Gas type ind.	Gas type independent
GB	Gas ballast
If necessary	If necessary
Size	Size
IK	Immission condenser
IN ¹	Inlet, vacuum connection
KF	Small flange
Max.	Maximum value
Min.	Minimum value
w/o EK	Without emission condenser
PA	Polyamide
PBT	Polybutylene terephthalate
PC ...	Chemistry pumping unit with type code
PE	Polyethylene
RMA No.	Return authorization number
so-called	so-called
SW	Wrench size (tool)
TE	Dry ice condenser
resp.	Responsible person(s)
e.g.	For example

¹ Labeling on vacuum pump or component, see also product specific abbreviations under:
→ **Chemistry pumping unit series on page 28**

1.7 Explanation of terms

Product-specific terms

Separator flask	Glass flask/separator installed at the inlet or outlet.
Emission condenser²	Cooling condenser with receiving flask installed at the outlet (pressure side).
Fine vacuum	Pressure measurement range in the vacuum technology, from: 1 mbar–0.001 mbar (0.75 Torr–0.00075 Torr)
Rough vacuum	Pressure measurement range in the vacuum technology, from: Atmospheric pressure–1 mbar (atmospheric pressure–0.75 Torr)
Immission condenser²	Cooling condenser with receiving flask installed at the inlet (vacuum side).
PC 5xx select PC 6xx select	Vacuum pumping unit with valves for manual and/or electronic vacuum regulation with VACUU·SELECT controller and VACUU·SELECT sensor.
PC 510 / PC 610	Electronically regulated operation of a process with a vacuum pump. 1x vacuum connection: = 1x electronic valve
PC 511 / PC 611	Electronically regulated operation of a process with a vacuum pump. 2x vacuum connection: = 1x manual flow control valve = 1x electronic valve
PC 520 / PC 620	Electronically regulated operation of a process with a vacuum pump. 2x vacuum connection: = 1x electronic valve – Process A = 1x electronic valve – Process B
Peltronic	Electronic cooler with Peltier elements installed at the outlet (pressure side); condenses solvent vapors without external cooling medium.
Dry ice condenser²	Cooling condenser with receiving flask and dry ice as cooling medium installed at the outlet (pressure side).
VACUU·BUS	VACUUBRAND bus system for the communication of peripheral devices with VACUU BUS-capable measuring equipment and controllers.
VACUU·BUS address	Address that enables a clear assignment of the VACUU BUS client in the bus system, e.g. for the connection of several sensors of the same measurement range.

² Only suitable for the condensation of vapors.

VACUU BUS client	Peripheral device or components with VACUU BUS connection, which is integrated in the bus system, e.g. sensors, valves, level indicators, etc.
VACUU BUS plug	4-pin round plug for the VACUUBRAND bus system.
VACUU BUS configuration	Using a measuring device or controller to assign a new VACUU BUS address to a VACUU BUS component.
VACUU-SELECT	Vacuum controller, controller with touchscreen; consisting of control unit and vacuum sensor.
VACUU-SELECT sensor	Vacuum sensor with integrated venting valve.
VARIO drive	Speed control for vacuum pumps; the motor only runs as fast as needed.

2 Safety instructions

The information in this chapter must be observed by all persons who work with the device described here.

The safety instructions are valid for all life stages of the product.

2.1 Use

The device may only be used in perfect technical condition.

2.1.1 Proper use

Proper use A chemistry pumping unit of the PC 5xx/6xx select product series is a vacuum system consisting of a vacuum pump, controller, vacuum sensor and separator for generating and regulating a rough vacuum in installations designed for this purpose.

A type PC 520 select or PC 620 select chemistry pumping unit is also designed for the simultaneous operation of two applications with electronic regulation.

Attached coolers (emission condenser, immission condenser, dry ice cooler, Peltronic emission condenser), including separator and flask, are exclusively designed for condensing vapors.

Application example: Evacuating distillation instruments, rotary evaporation, facilities with VACUU LAN network, vacuum drying.

The vacuum system should only be used in a dry, non-explosive environment.

Proper use also includes:

- following the instructions in the document *Safety instructions for vacuums*,
- observing the instruction manual,
- observing the instruction manual of connected components,
- complying with inspection and maintenance intervals and having this carried out only by qualified personnel.
- using only approved accessories or replacement parts.

Any other use or use beyond this is considered improper.

2.1.2 Improper use

Improper use Improper use or any use that does not correspond with the technical data can lead to personal or material damage.

Improper use is considered:

- use that contradicts the proper use,
- operation in unauthorized ambient and operating conditions,
- operation with obvious faults, damages or defective safety equipment,
- unauthorized extensions and modifications, especially when these compromise safety,
- use in an incomplete state,
- operation with sharp-edged objects,
- pulling connectors on the cable out of the socket,
- vacuuming, pumping and condensing solid materials or liquids.

2.1.3 Foreseeable misuse

Misuse In addition to improper use, there are other types of use that are forbidden when handling the device.

Forbidden types of use are primarily:

- use on people or animals,
- setup and operation in a potentially explosive environment,
- use in mining or underground,
- using the product to generate pressure,
- fully exposing vacuum equipment to the vacuum,
- submerging vacuum equipment in liquids, exposing to spray water or steam spraying,
- pumping oxidizing and pyrophoric materials, liquids or solids,
- pumping media that is hot, unstable, potentially explosive or explosive,
- pumping materials that can react explosively under impact and/or increased temperature without air supply.

The user must prevent the penetration of foreign bodies, hot gases and flames.

2.2 Responsibilities

Follow the instructions for all actions as they are specified in this instruction manual.

Responsibilities of the operator

Operator responsibilities

The operator defines the responsibilities and ensures that only trained or qualified personnel work on the vacuum system. This applies in particular to connection, assembly work, maintenance tasks and fault elimination.

Users in the competency areas listed in the → **Target group description on page 17** must have the corresponding qualification for the listed activities. Only qualified electricians are permitted to carry out special work on electrical equipment.

Personnel responsibilities

Personnel responsibilities

For activities that require protective clothing, the personal protection equipment specified by the operator must be worn.

When the vacuum system is not in proper operating condition, it must be secured against accidental restart.

- ⇒ Always work with safety in mind.
- ⇒ Follow the operator's instructions and the national regulations on accident prevention and occupational safety.



Personal conduct can contribute to the prevention of occupational accidents.

2.3 Target group description

Target groups The instruction manual must be read and observed by every person entrusted with one of the following activities.

Personnel qualification

Qualification description

Operator	Laboratory personnel, e.g. chemists, physicists, lab technicians
Qualified employee	Person with professional qualification for maintenance and/or repair in the field of: mechanical systems, electrical systems or laboratory equipment. The assigned work can be assessed and potential dangers detected.
Responsible specialist	Qualified employee with additional field, department or division responsibility who is assigned by the operator.

Responsibility matrix

Who-does-what matrix

Task	Operator	Qualified employee	Responsible specialist
Installation	x	x	x
Initial operation	x	x	x
Network integration			x
Operation	x	x	x
Fault reporting	x	x	x
Fault elimination	(x)	x	x
Device fuse replacement		x	x
Maintenance		x	x
Repair ³		x	x
Repair order			x
Cleaning, simple	x	x	x
Emptying separator	x	x	x
Decommissioning	x	x	x
Decontamination ⁴		x	x

³ See also homepage: VACUUBRAND > Support > [Repair instructions](#)

⁴ Or have decontamination carried out by a qualified service provider.

2.4 General safety information

Quality standards
and safety

Products of **VACUUBRAND GMBH + CO KG** are subject to high quality control requirements in terms of safety and operation. Each product is put through an extensive test program before delivery.

Follow the instructions for all actions as they are specified in this instruction manual.

2.5 Protective clothing

Special protective clothing is not required for operation of the vacuum pump. Follow the operator's instructions for your workplace.

For cleaning, maintenance and repair work, we recommend wearing fully adequate protective gloves, clothing and glasses.

- ⇒ Wear your personal protection equipment when handling chemicals.

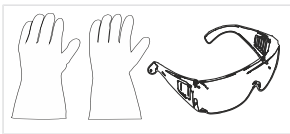

2.6 Safety measures

Manufacturer mea-
sures

Products of **VACUUBRAND GMBH + CO KG** are subject to high quality control requirements in terms of safety and operation. Each product is put through an extensive test program before delivery.

Operator measures

Operator measures

- ⇒ Use your vacuum only when you have understood the instruction manual and the operation.
- ⇒ Replace defective components immediately, e.g. broken power cables, defective hoses or flasks.
- ⇒ Use only original accessories and components that are designed for the vacuum technology, e.g. vacuum hose, separator, vacuum valve, etc.
- ⇒ When handling contaminated parts, follow the relevant regulations and protection measures; this also applies to sending parts in for repair.
- ⇒ For repairs, send us the carefully filled out and signed **Clearance Certificate** **before** you send your product in for repair. Hazardous materials must be able to be excluded for all repair shipments to our service department.

2.7 Laboratory and work materials



DANGER

Hazardous materials leak at the outlet.

When operating the vacuum, hazardous, toxic substances can leak into the ambient air at the outlet.

- Please observe the safety regulations for handling hazardous materials and media.
- Remember that adhesive process media can present a danger to humans and the environment.
- Install and use suitable separators, filters or extraction equipment.

Dangers posed by different substances

Pumping different substances

Pumping different substances or media can trigger a reaction between materials.

Work materials that leak into the vacuum pump with the gas flow can damage the vacuum pump. Hazardous substances can form deposits in the vacuum pump.

Possible protective measures

Protective measures, depending on the application

- ⇒ Rinse the vacuum pump with inert gas or air before you change the pumping medium.
- ⇒ Use inert gas to dilute critical mixtures.
- ⇒ Prevent the release of hazardous, toxic, explosive, corrosive, health-damaging or environmentally harmful fluids, gases or vapors, e.g. by using suitable laboratory equipment with an extraction system and ventilation control.
- ⇒ Protect the inside of the vacuum pump from deposits or humidity, e.g. by using a gas ballast feed system.
- ⇒ Observe the interactions and possible chemical reactions of the pumped media.
- ⇒ Check the compatibility of the pumped substances with the medium-affected materials of the pumping unit.
- ⇒ Contact us if you have concerns about using your vacuum pump with special work materials or media.

Preventing foreign bodies inside the pump

Observing the vacuum pump design

Particles, liquids and dust are not permitted inside the vacuum pump.

- ⇒ Do not pump any substances that can form deposits inside the vacuum pump.
- ⇒ Install suitable separators and/or filters in front of the inlet. Suitable filters are chemical resistant, clog-free and ensure a constant flow rate.
- ⇒ Replace porous vacuum hoses promptly.

2.8 Possible sources of danger

Considering mechanical stability

Observing mechanical stability

Due to the high compression ratio of the pumps, a higher pressure can build up at the outlet than the mechanical stability of the system allows.

- ⇒ Always ensure that the exhaust line is open and free of pressure. To guarantee an unobstructed emission of gases, the outlet must remain unblocked.
- ⇒ Prevent uncontrolled excess pressure, e.g. due to shut-off or blocked piping system, condensate or clogged exhaust line.
- ⇒ At the gas connections, the connections for inlet (IN) and outlet (EX) must never be confused.
- ⇒ Observe the max. pressure at the inlet and outlet of the pump as well as the max. permissible differential pressure between inlet and outlet, in accordance with the *technical data*.
- ⇒ The system to be evacuated and all hose connections must be mechanically stable.
- ⇒ Attach the coolant hoses to the hose nozzles so that they do not come loose unintentionally.

Preventing condensate return flow

Preventing backlog in the exhaust line

Condensate can damage the pump head. Condensate must never flow back through the hose line into the outlet and into the pump head. Liquid is not allowed to collect in the exhaust line.

- ⇒ Prevent condensate return flow by using a separator. Condensate is not allowed to enter the inner housing through the hose lines.

- ⇒ If possible, lay the exhaust hose so that it is descending from the outlet; i.e. running downward, so that no backlog can form.
- ⇒ Incorrect measurement due to blocked vacuum line, e.g. condensate in the vacuum line can distort the measurements of the vacuum sensor.
- ⇒ Prevent excess pressure in the suction hose (>/ 1060 mbar [>/ 795 Torr]).

Dangers during ventilation

Looking out for dangers during ventilation

Depending on the process, a potentially explosive mixture can form in installations or other dangerous situations can occur.

Dangers due to residual energy

Possible residual energies

After the vacuum pump has been switched off and disconnected from the power network, dangers may still be present due to residual energies:

- Thermal energy: Motor waste heat, hot surface, compression heat.
- Electrical energy: Installed condensers have a discharge time of up to 3 minutes.

Please note the following before performing actions:

- ⇒ Allow the vacuum pump to cool down.
- ⇒ Wait until the condenser have discharged.

Dangers due to hot surfaces or overheating

Surface temperatures

The surface of vacuum pumps can reach temperatures greater than 70 °C during operation, especially when vacuuming heated media.

- ⇒ Avoid direct contact with the surface or wear heat-resistant safety gloves if contact cannot be excluded.
- ⇒ Provide contact protection if the surface temperature should be elevated on a regular basis.
- ⇒ Allow the vacuum pump to cool down before performing maintenance tasks.

Overheating

The vacuum pump can become damaged due to overheating. Potential causes are insufficient air supply to the cooling fan and/or non-compliance with minimum distances.

- ⇒ When setting up the device, observe a minimum distance of 5 cm between the cooling fan and adjacent parts (e.g. housing, walls, etc.).
- ⇒ Always ensure that there is sufficient air supply; if necessary, provide an external forced ventilation system.
- ⇒ Place the device on a stable surface. A soft surface, e.g. foam as sound absorber, can impair and block the supply of air.
- ⇒ Clean dirty ventilation slots.
- ⇒ Remove the cover hood used as transport protection before you put the device into operation.
- ⇒ Avoid applying too much heat due to hot process gases.
- ⇒ Observe the maximum permissible media temperature according to the *technical data*.

Ensure that signs are readable

Labels and signs

Make sure that instructions and signs attached to the device remain in a readable condition:

- ⇒ Labels for connections
- ⇒ Warning and information signs
- ⇒ Motor data and type plates

2.9 Motor protection

	CAUTION
	<p>Limited winding protection with supply voltages less than 115 V AC.</p> <p>With supply voltages less than 115 V AC, the self-locking mechanism of the winding protection can be limited. After cooling, this can cause the pump to start automatically.</p> <p>➤ When overheating, switch the pump off to avoid an automatic restart.</p>

Overheating protection, blockage protection

The pump motor has a self-locking thermal winding mechanism to protect it against overload. If the temperature is excessive or the motor is blocked, the vacuum pump switches off.

Restart procedure

If the vacuum pump switches off due to these safety measures, the fault must be reset manually: Disconnect the pumping unit from the power supply -> Eliminate the cause of the error -> Restart the pumping unit after a wait time of approx. 5 minutes.

2.10 ATEX device category

Installation and explosive environment

Installation and operation in areas where an explosive atmosphere can occur in dangerous quantities is not permitted.

The user is responsible for assessing the hazards for the device, so that any protection measures can be implemented for the installation and safe operation.

The ATEX certification applies only for the inner area in contact with media of the of the vacuum pump, not for the surrounding area.

ATEX device marking

ATEX device category



Vacuums labeled with the marking  are certified in accordance with the ATEX marking on the type plate.

Operation is only permitted in technically sound condition.

The product is designed for a low degree of mechanical danger and must be installed so that it cannot be mechanically damaged from the outside.

ATEX device category and peripheral devices

The ATEX device category of the of the vacuum pump depends on the connected components and the periphery. Components and peripheral devices must have the same or higher ATEX classification.

Preventing sources of ignition

The use of ventilation valves is only permitted if it is ensured that this normally does not produce explosive mixtures in the interior of the of the vacuum pump or that in all probability explosive mixtures are only briefly or rarely produced.

⇒ If necessary, ventilate with inert gas.

Information about the ATEX device category can be found online: [ATEX information](#)

Explanation of usage conditions X
Type plate example



Restrictions on operating conditions

Meaning for devices marked with **X**:

- The devices have a low mechanical protection and must be installed so that they cannot be mechanically damaged from the outside; e.g., installing pumping units with impact protection, attaching shatter protection for glass flasks, etc.
- The devices are designed for an ambient and media temperature of +10 °C to – +40 °C during operation. These ambient and media temperatures must never be exceeded. When conveying/measuring non-explosive gases, extended gas suction temperatures apply, see chapter: Technical data, media temperature (gas).

2.11 Disposal

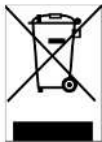

NOTICE

Improper disposal of electronic components can result in damage to the environment.

Electronic equipment contains hazardous materials that can damage the environment or human health. Discarded electronic equipment also contains valuable raw materials, which can be recovered if properly disposed of for recycling.

End users are required by law to bring waste electrical and electronic equipment to an approved collection site.

- ⇒ Please properly dispose of electrical waste and electronic components at the end of their service life.
- ⇒ Observe the national regulations on disposal and environmental protection.

2.12 ATEX device category

Installation and explosive environment

Installation and operation in areas where an explosive atmosphere can occur in dangerous quantities is not permitted.

The user is responsible for assessing the hazards for the device, so that any protection measures can be implemented for the installation and safe operation.

The ATEX certification applies only for the inner area in contact with media of the of the vacuum pump, not for the surrounding area.

ATEX device marking

ATEX device category



Vacuums labeled with the marking  are certified in accordance with the ATEX marking on the type plate.

Operation is only permitted in technically sound condition.

The product is designed for a low degree of mechanical danger and must be installed so that it cannot be mechanically damaged from the outside.

ATEX device category
and peripheral de-
vices

The ATEX device category of the of the vacuum pump depends on the connected components and the periphery. Components and peripheral devices must have the same or higher ATEX classification.

Preventing sources
of ignition

The use of ventilation valves is only permitted if it is ensured that this normally does not produce explosive mixtures in the interior of the of the vacuum pump or that in all probability explosive mixtures are only briefly or rarely produced.

⇒ If necessary, ventilate with inert gas.

Information about the ATEX device category can be found online:
[ATEX information](#)

Restrictions on operating conditions

Explanation of usage
conditions X
Type plate example

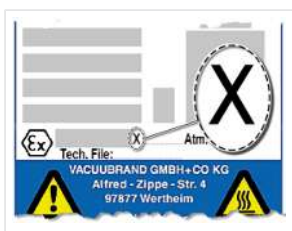

Meaning for devices marked with **X**:

- The devices have a low mechanical protection and must be installed so that they cannot be mechanically damaged from the outside; e.g., installing pumping units with impact protection, attaching shatter protection for glass flasks, etc.
- The devices are designed for an ambient and media temperature of +10 °C to – +40 °C during operation. These ambient and media temperatures must never be exceeded. When conveying/measuring non-explosive gases, extended gas suction temperatures apply, see chapter: Technical data, media temperature (gas).

3 Product description

Pumping units of the PC 5xx/6xx select series essentially consist of membrane pump, regulated by Electromagnetic and/or manual inlet valves, a VACUU·SELECT® vacuum controller as well as a cooler with a separator. Coolers are available in different designs. The coolers differ in how they function.

3.1 Basic configuration of pumping unit series

View and basic configuration
PC 5xx/6xx select

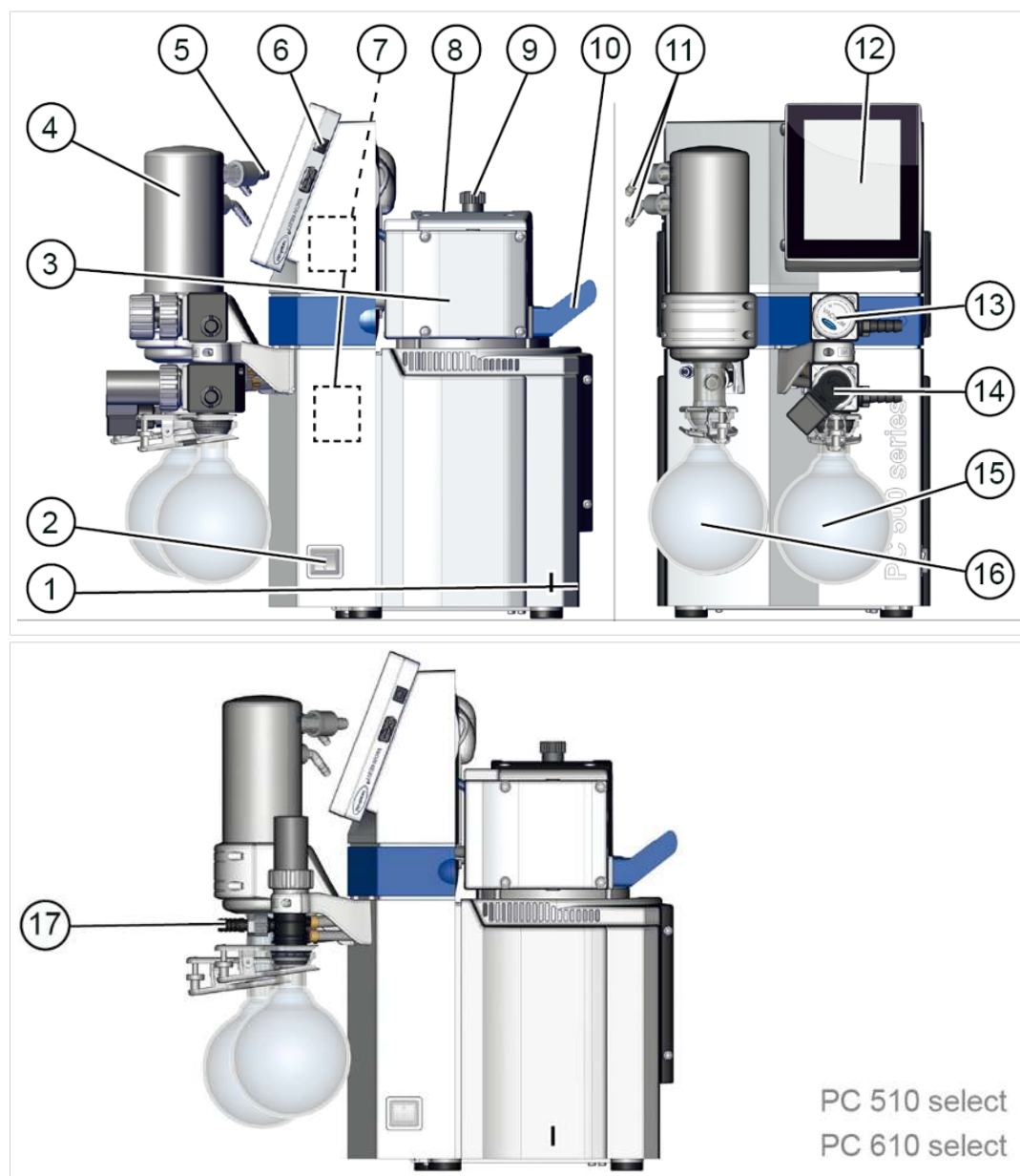

Meaning

- 1 Power connection, device fuse, VACUU BUS, Ethernet
- 2 On/Off switch (rocker switch) pumping unit
- 3 Chemical membrane pump

- 4** Emission condenser EK
- 5** Outlet – Exhaust connection
- 6** On/Off button VACUU·SELECT® Controller
- 7** VACUU·SELECT® Sensor(s), installed in pumping unit housing
- 8** Nameplate
- 9** Gas ballast valve
- 10** Handle
- 11** Coolant connections
- 12** VACUU·SELECT® control unit, removable
- 13** Inlet – Vacuum connection (valve block), with manual flow control valve
- 14** Inlet – Vacuum connection (valve block), with electronically-controlled valve
- 15** Separator flask AK, round flask at inlet
- 16** Round flask at outlet
- 17** Only version: PC 510 or PC 610: Inlet – Vacuum connection (distributor head), with electronically-controlled valve

3.2 Chemistry pumping unit series

Overview of chemistry pumping unit models



Meaning

Chemistry pumping unit	Pump head	Steps	Valve manual	Valve electric
a PC 510 select	2	2		1x
b PC 610 select	4	3		1x
c PC 511 select	2	2	1x	1x
d PC 611 select	4	3	1x	1x
e PC 520 select	2	2		2x
f PC 620 select	4	3		2x

Product-specific abbreviations

Product-specific abbreviations

AK	Separator flask, installed at inlet or outlet
EK	Emission condenser, installed at outlet
PC	Chemistry pumping unit with type code

3.3 Condensers and coolers

3.3.1 Separator/condenser at inlet

Connection on separator flask

Connections on AK

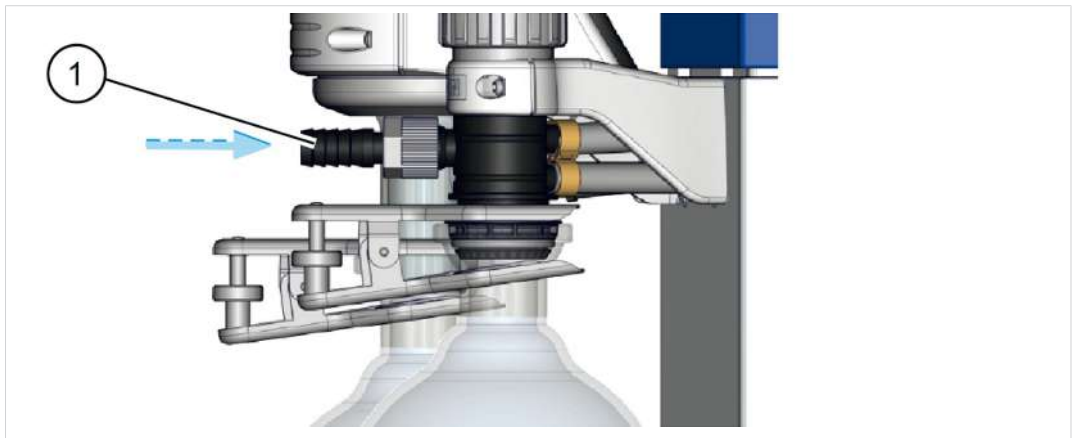

Meaning

1	Vacuum inlet connection IN
----------	----------------------------

3.3.2 Condenser at outlet

Connection and coolant on emission condenser

Connections on EK



Meaning

1	Outlet connection coolant EX
2	Inlet connection coolant IN, e.g. water
3	Outlet connection EX

3.4 Application example

Local area vacuum network

-> Example
Local area vacuum
network

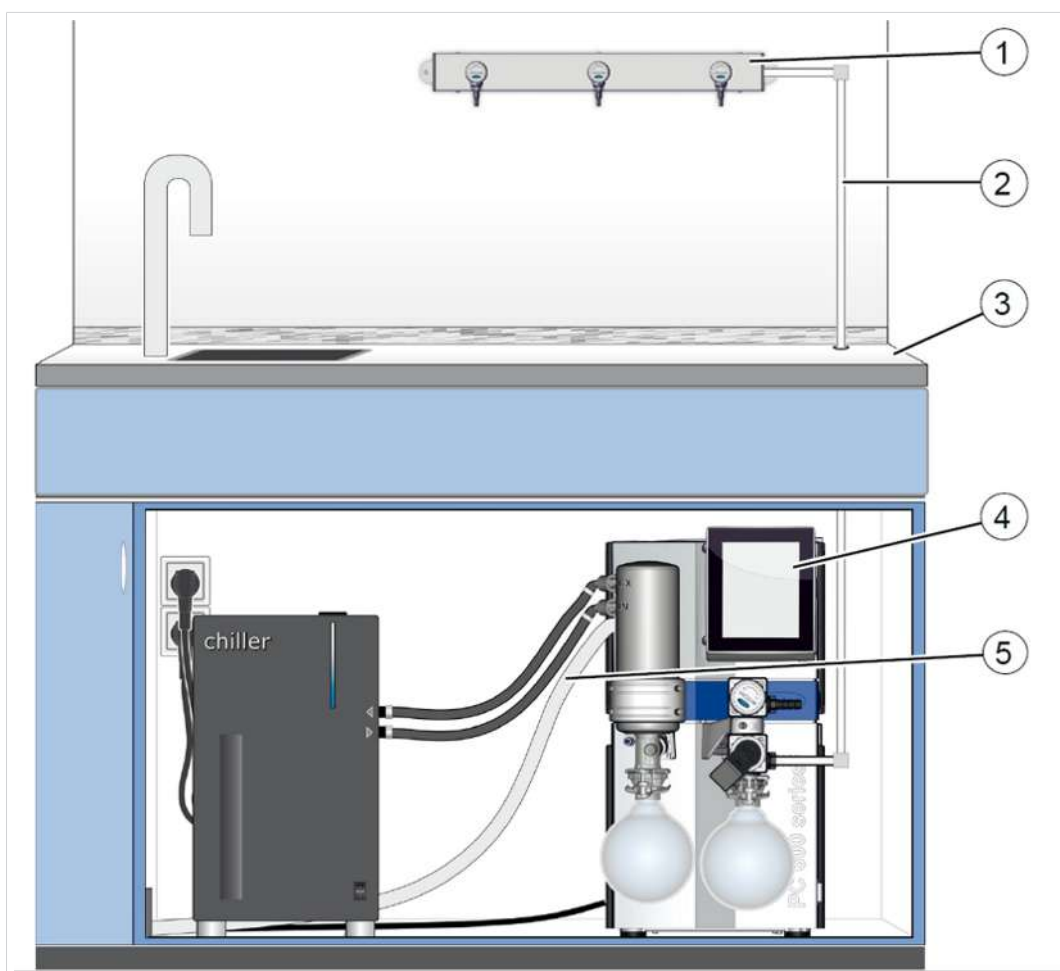

Description

- 1 Process example: VACUU-LAN®, local area vacuum network with three valve modules
- 2 Vacuum hose (permanently installed PTFE hose lines)
- 3 Lab furniture
- 4 **PC 611 select** vacuum pumping unit
- 5 Exhaust gas hose (diverted into a fume hood)

Drying

-> Example Drying

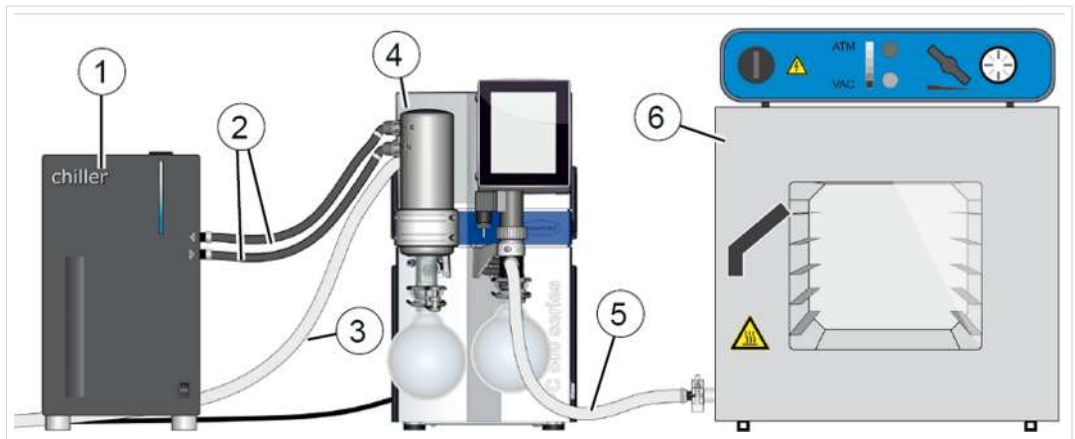

Description

- 1 Chiller
- 2 Coolant hoses
- 3 Exhaust gas hose (diverted into a fume hood)
- 4 **PC 510 select** vacuum pumping unit
- 5 Vacuum hose
- 6 Example of use: drying cabinet

Control of two applications in parallel

-> Example Vacuum control of 2 processes

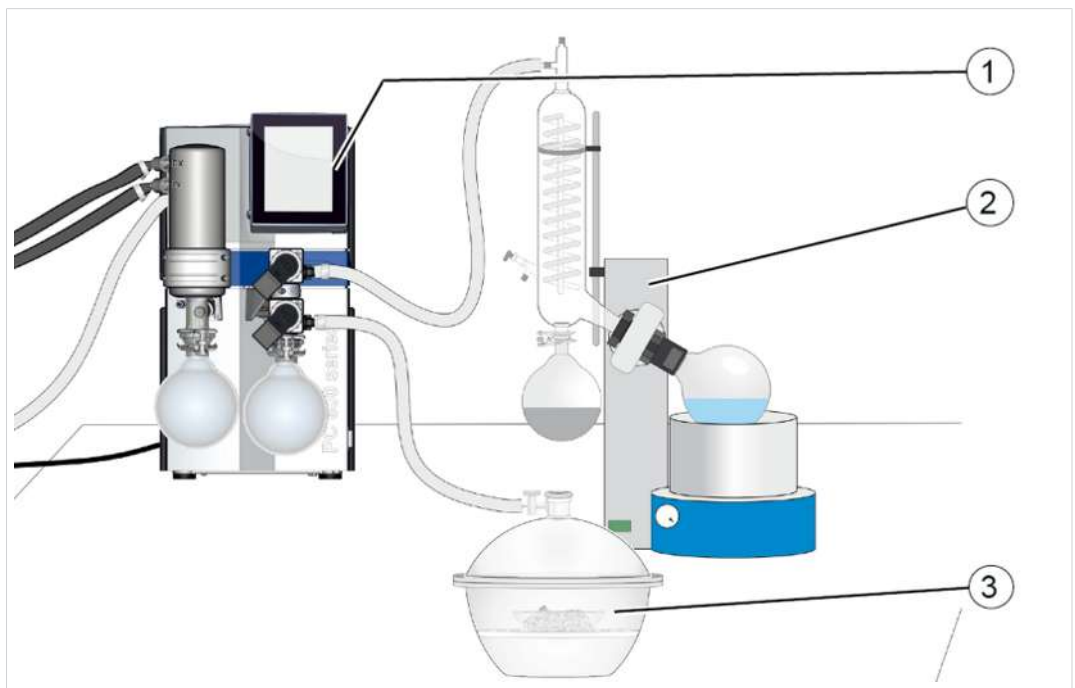

Description

- 1 **PC 620 select** vacuum pumping unit
- 2 Process B: Rotary evaporation
- 3 Process A: drying with desiccator

4 Installation and connection

4.1 Transport

Products from **VACUUBRAND** are packaged in stable, recyclable packaging.



The original packaging is customized to your product for safe transport.

⇒ If possible, keep the original packaging, e.g. for sending in for repairs.

Incoming goods

- ⇒ Check the delivery immediately after receipt for any transport damage and for completeness.
- ⇒ Promptly report transport damage to the supplier in writing.

Unpacking

-> Example
Pumping unit in original packaging

Glass flask in enclosed box

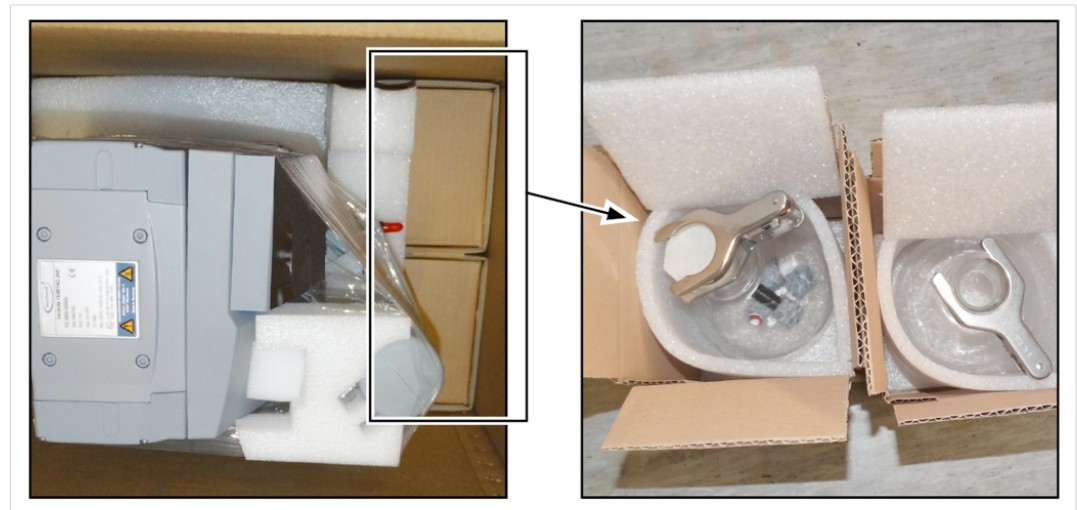

1. Remove the connections from the glass flask, such as hose nozzles and screw fasteners.
2. Compare the scope of delivery with the delivery notice.

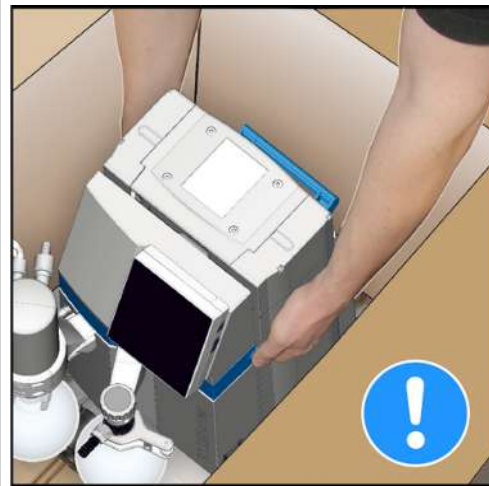

Please note that the pumping unit can weigh more than 20 kg.

Lift the device out of the packaging using the recessed grips on the sides.

Never use attachment parts such as brackets or glass flasks to aid in lifting.

Use only the recessed grips on the sides and/or the handle to transport it to the installation location.

4.2 Installation

NOTICE

Condensate can damage the electronics.

A large difference in temperature between the storage location and the installation site can lead to the formation of condensate.

⇒ After receipt or storage, allow your vacuum to acclimatize for at least 3–4 hours before putting it into operation.

Checking the installation conditions

Calibrating the installation conditions

- The device is acclimatized.
- The ambient conditions are met and lie within the limitations of use.
- The pump must be installed on a stable and secure floor, with no other mechanical contact apart from the pump feet.

Installing the vacuum pump

-> Example
Sketch of minimum
distances in labora-
tory furniture

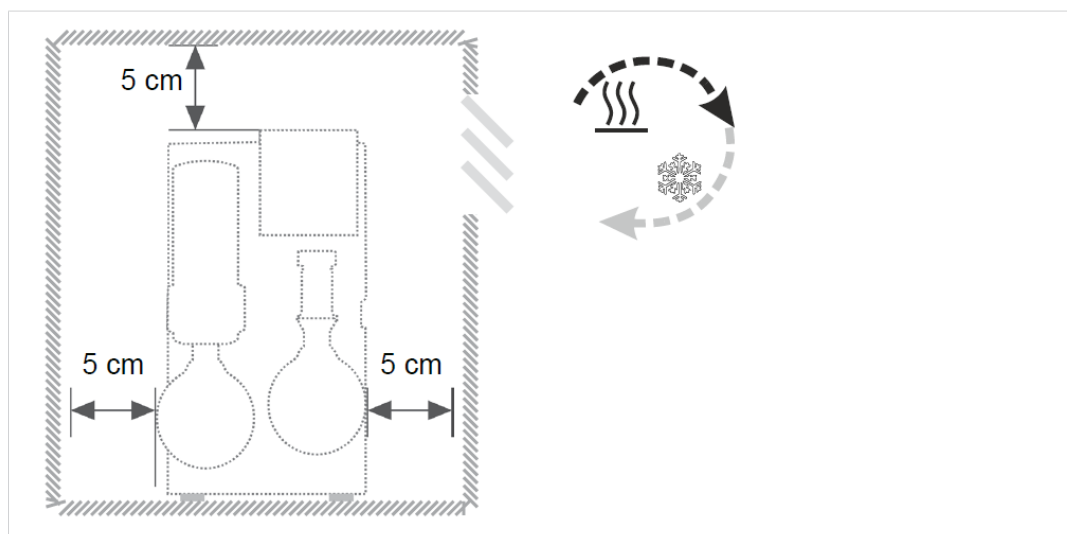

- ⇒ Place the vacuum pump on a stable, vibration-free, level surface.
- ⇒ When installing laboratory furniture, maintain the minimum distance of 5 cm (2 in.) to adjacent objects or surfaces.
- ⇒ Avoid heat accumulation and ensure sufficient air circulation, especially in closed housings.

Observing the limitations of use

Ambient conditions

Ambient conditions		(US)
Ambient temperature	10–40 °C	50–104°F
Installation height, max.	2000 m above sea level	6562 ft above sea level
Humidity	30–85 %, non-condensing	
Degree of contamination	2	
Impact energy	5 J	
Protection class (IEC 60529)	IP 20	
Protection class (UL 50E)	Type 1	
Avoid condensate or contamination from dust, liquids and corrosive gases.		

- ⇒ Note the indicated IP protection rating. The IP protection is only guaranteed if the device properly installed and connected.
- ⇒ When connecting the device, always take note of the specifications from the type plate and in the chapter technical data.

4.3 Connection (supply connections)

On the pumping unit, supply connections are provided for vacuum and exhaust, and optionally for gas ballast, ventilation and coolant. Set up the connection for your pumping unit as described in the following examples. Also attach the provided screw fasteners and glass flasks to the condensers.

4.3.1 Vacuum connection (IN)



CAUTION

Flexible vacuum hoses can contract during evacuation.

Non-fixed, connected components may cause injury or do damage due to the jerky movement (shrinking) of the flexible vacuum hose. The vacuum hose can come loose.

- Fasten the vacuum hose to the connections.
- Fasten connected components.
- Measure the flexible vacuum hose so that the maximum shrinkage, i.e. the contraction, is taken into account.

NOTICE

Foreign bodies in the suction line can damage the vacuum pump.

- ⇒ Prevent particles, liquids or contaminants from being vacuumed or from being able to flow back.

Connecting the vacuum hose

-> Example
Vacuum connection
at inlet IN

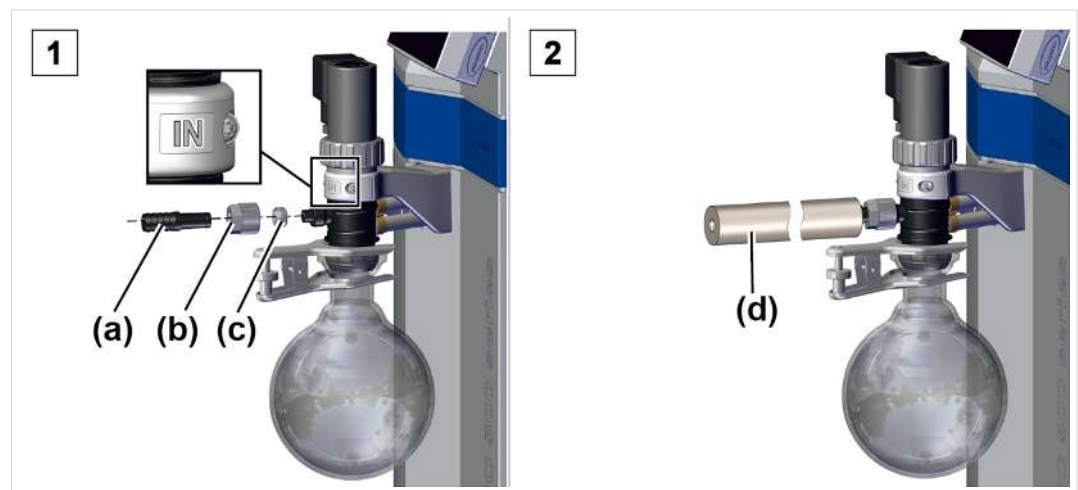

1. Join the sealing ring **(a)**, the cap nut **(b)** and hose nozzle **(c)** as pictured.
2. Slide the vacuum hose **(d)** from the apparatus onto the hose nozzle and fasten the vacuum hose, e.g. with a hose clamp.



You will achieve the optimal vacuum for your application if you observe the following points:

- ⇒ Connect the shortest possible vacuum line with the maximum possible cross-section.
- ⇒ Use a vacuum hose with sufficient stability that is designed for the vacuum range used.
- ⇒ Connect hose lines so they are gas tight.

Connect vacuum hose PC 520 (620)

-> Example
Vacuum connection
for two processes
A / B

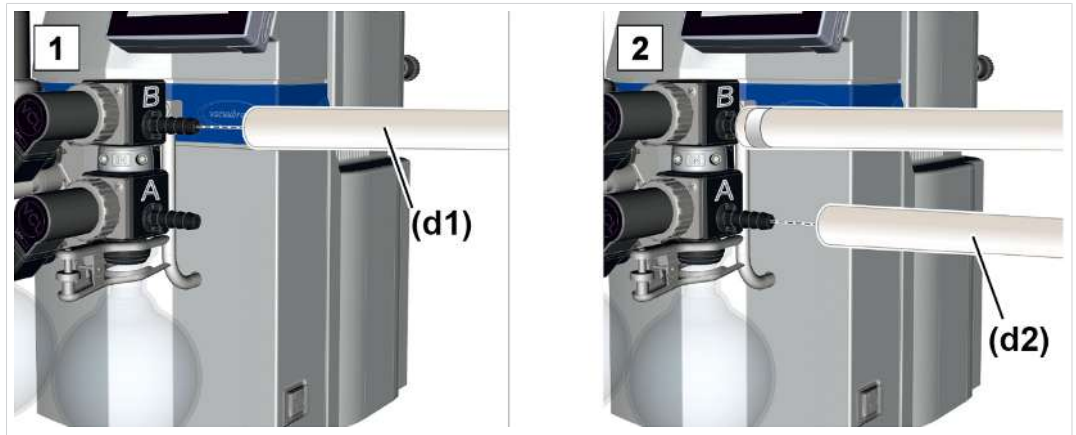

1. Push the first vacuum hose **(d1)** for *process B* onto the hose nozzle of valve B and secure the vacuum hose.
2. Push the second vacuum hose **(d2)** for *process A* onto the hose nozzle of valve A and secure the vacuum hose.

4.3.2 Exhaust connection (OUT)



WARNING

Risk of bursting due to excess pressure in the exhaust line.

Unacceptably high pressure in the exhaust line may cause the vacuum pump to burst or damage seals.

- The exhaust line (outlet, gas outlet) must always be open and free of pressure.
- Always lay the exhaust hose so that it is descending, or take measures to prevent condensate return flow into the vacuum pump.
- Observe the maximum allowable pressures and pressure differentials.

Connecting the exhaust hose

-> Example
Exhaust connection
at outlet EX

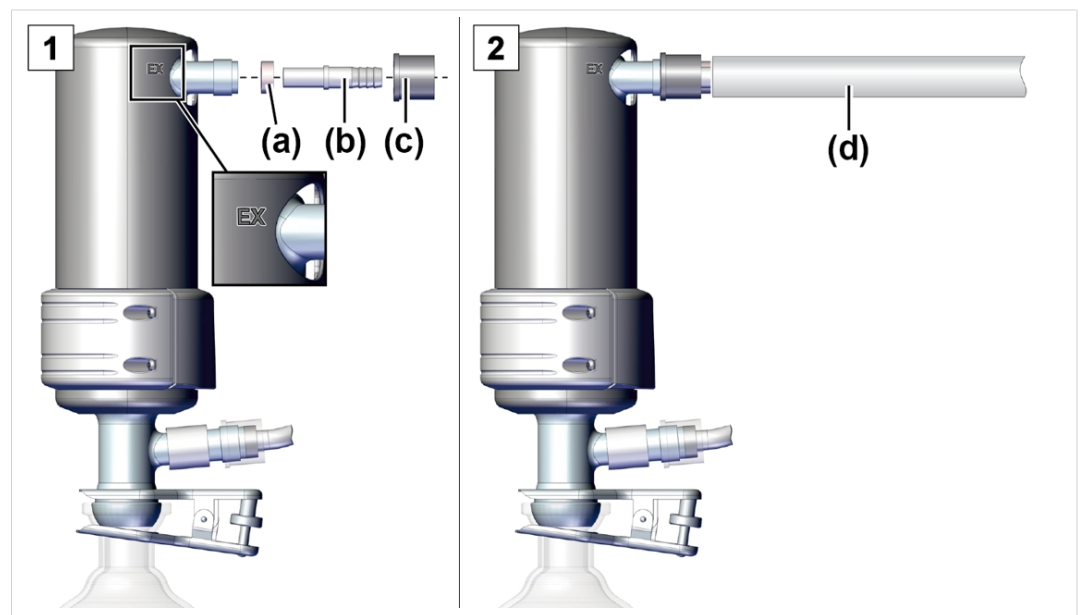

1. Join the rubber sealing ring **(a)**, the hose nozzle **(b)** and the cap nut **(c)** as pictured and screw this onto the connection.
2. Slide the exhaust hose **(d)** onto the hose nozzle and, if necessary, route the hose to a fume hood. If necessary, fasten the exhaust hose, e.g. with a hose clamp.

4.3.3 Coolant connection on the condenser

Coolant connection
Inflow and outflow

An emission condenser EK has one connection for coolants. Water or liquid in the circuit of a recirculating chiller, for example, is suitable for cooling.

- In a closed, internal coolant circuit, the pressure should be limited to 3 bar (44 psi).
- A cooling water valve may only be installed in the inflow, the coolant outflow must be open and free of pressure.

Connecting coolant

-> Example
Coolant connection
on EK

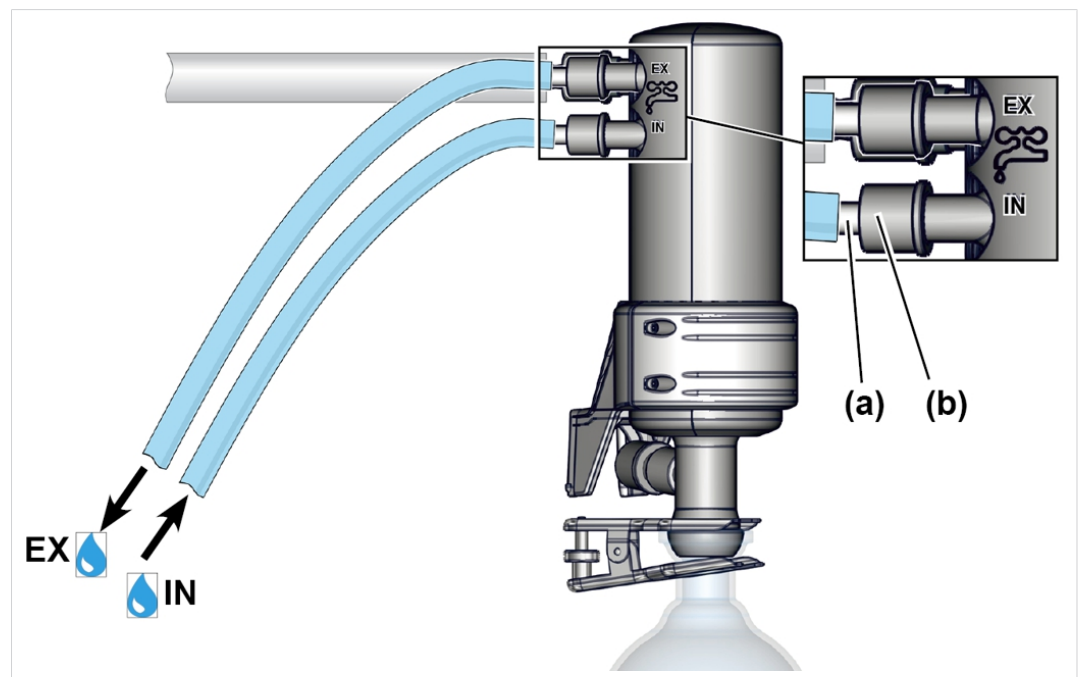

1. Fasten both hose nozzles **(a)** with the union nut **(b)** to the condenser as pictured.
2. Attach the hoses for the coolant according to the illustration on the condenser:
IN = Inflow
EX = Outflow
3. Fasten the hoses, e.g. with hose clamps.

4.3.4 Venting connection



DANGER

Explosion risk due to air ventilation.

Depending on the process, a potentially explosive mixture can form during ventilation, or other dangerous situations can occur.

- Never ventilate processes with air in which a potentially explosive mixture can form.
- When flammable substances are present, use only inert gas for ventilation, e.g. nitrogen (max. 1.2 bar/900 Torr abs.).

Vent with ambient air⁵

Position of venting connection

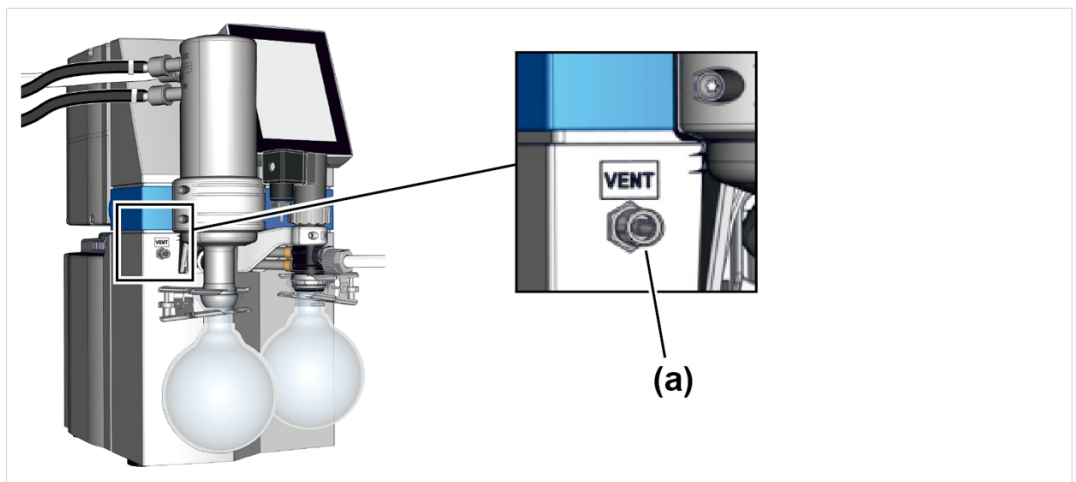

Nothing must be connected to venting valve **(a)** for venting with ambient air.

⁵ Only applicable to sensors with an integrated venting valve.

Vent with inert gas – connect venting valve⁶

Required connection material: Hose for inert gas connection (Ø 4 mm), e.g., silicone tube 4/6 mm.

Venting valve inert
gas connection

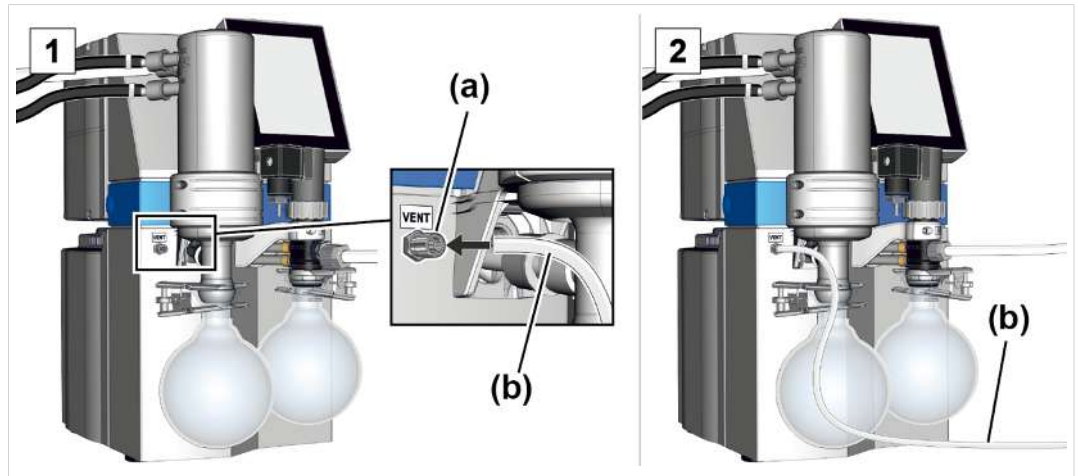

1. Insert hose **(b)** into VENT connection **(a)** and secure the hose with the union nut.
2. Connect hose **(b)** to inert gas (max. 1.2 bar/900 Torr, abs.).

⁶ Avoid overpressure.

4.3.5 Gas ballast (GB)

Use ambient air as gas ballast



DANGER

Explosion risk due to air as gas ballast.

By using air as a gas ballast, a small amount of oxygen enters the inside of the vacuum pump. Depending on the process, a potentially explosive mixture can form due to oxygen in the air, or other dangerous situations can occur.

- In the presence of flammable substances and for processes in which a potentially explosive mixture can occur, use only inert gas as a gas ballast, e.g. nitrogen (max. 1.2 bar/900 Torr abs.).

Gas ballast valve position

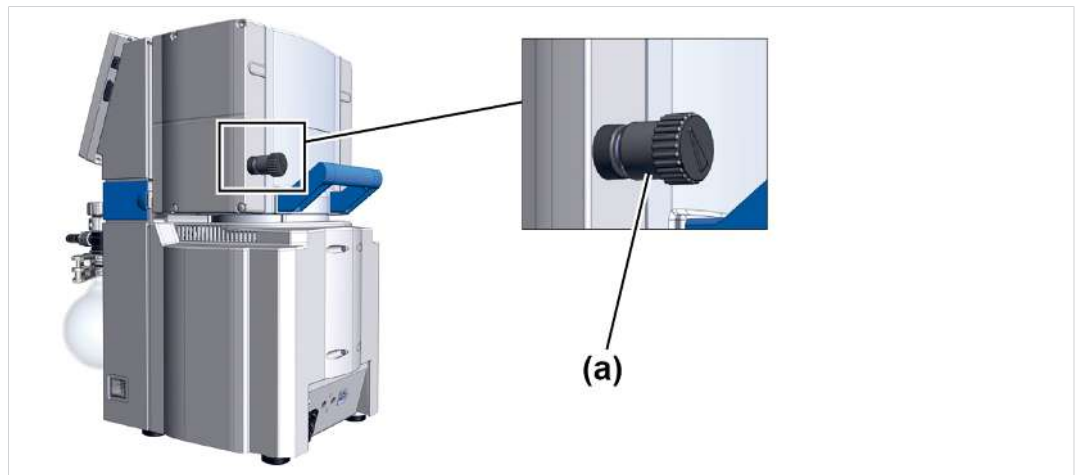

If ambient air is to be used as gas ballast, nothing needs to be connected at the pumping unit; gas ballast valve **(a)**; see also chapter: → **Operation with gas ballast on page 51**

Use of inert gas as gas ballast – OPTION

Prepare the inert gas connection (GB)

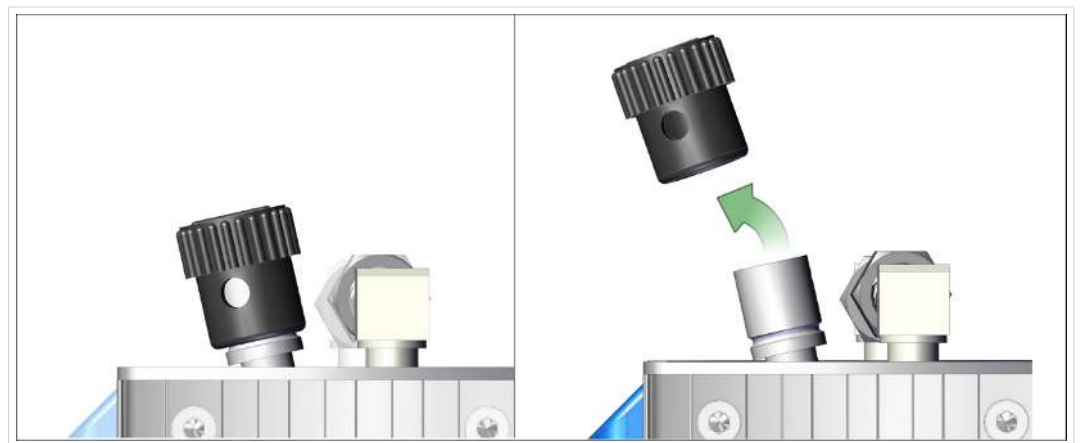

- ⇒ Remove the black gas ballast cap and connect a gas ballast adapter in its place.



On request, we can send you connection options and adapters for hose nozzles or small flanges.

4.4 Electrical connection

Connecting the pumping unit to the electrical system

-> Example
Electrical connection
of the pumping unit

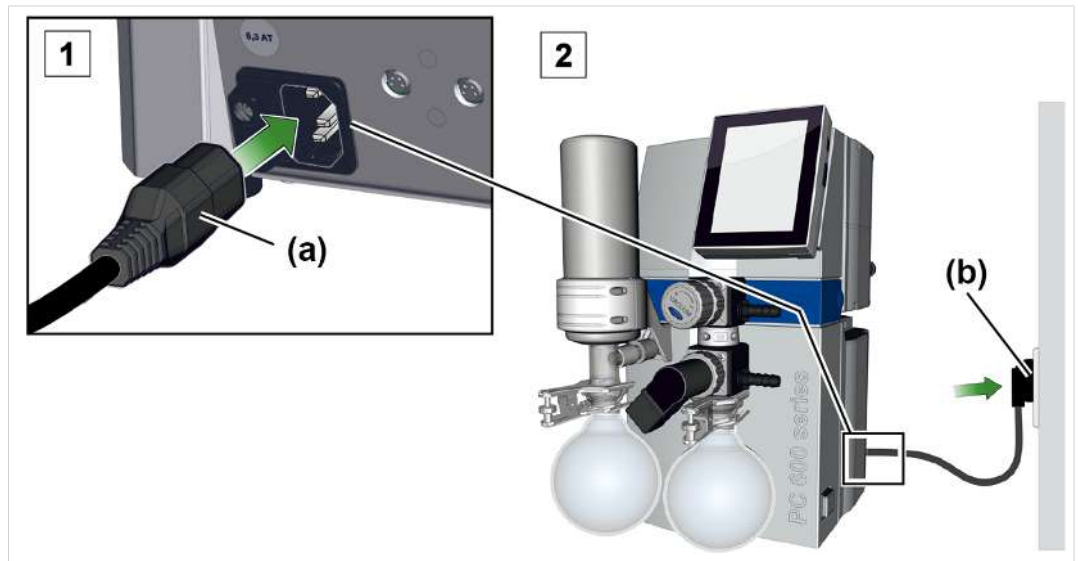

1. Plug the socket **(a)** of the power cable into the power connection of the vacuum pump.
2. Connect the power plug **(b)** to the power outlet.

Pumping unit connected to the electrical system.

NOTICE! Lay the power cable so that it cannot be damaged by sharp edges, chemicals or hot surfaces.

Power connections with country code

-> Example
Power plug types

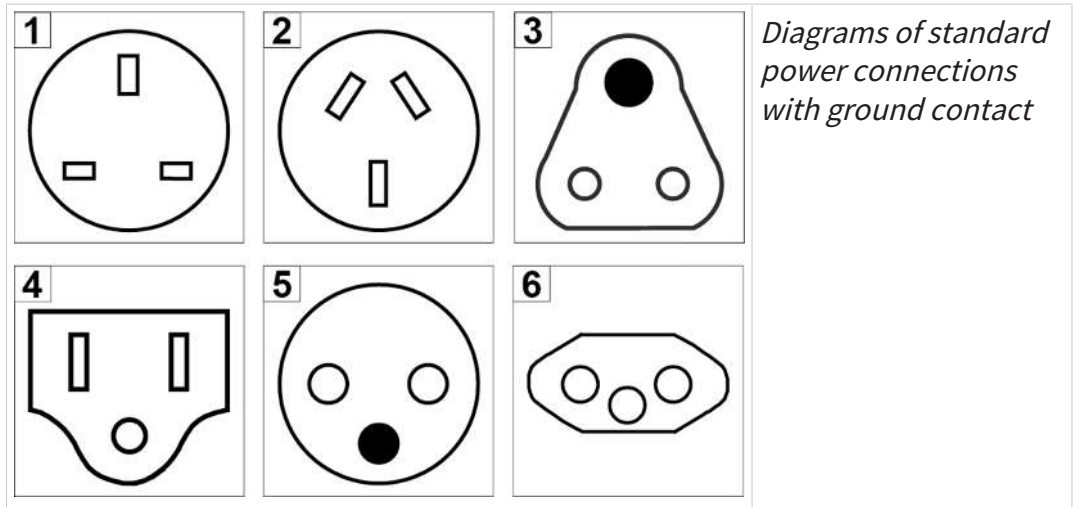

Diagrams of standard power connections with ground contact

1 UK

2 CN

3 IND

4 US

5 CEE

6 CH

The vacuum pump is delivered ready for use with the matching power plug.

NOTICE!

- ⇒ Use the power plug that matches your power connection.
- ⇒ Do not use multiple-socket power strips as a power connection.
- ⇒ The power plug also works as a circuit breaker. Set up the device so that the plug can be easily disconnected from it.

Connection options for vacuum accessories

The VACUU BUS interface functions as the power supply and control line for vacuum accessories.

1. Connect your accessories to your controller via the VACUU·BUS cable.
2. If necessary, increase the range and the number of connections with a suitable Y-adapter and extension cable.

-> Example
Schematic drawing
of controller with
connected valve and
sensors

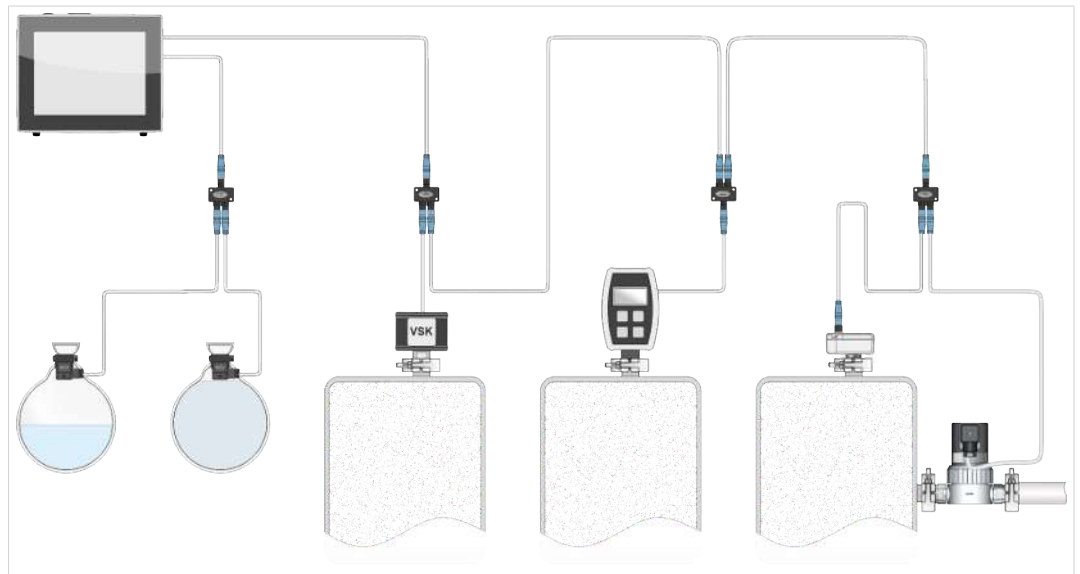

Accessories -> see chapter Ordering information

5 Operation

Before putting into operation, make sure that the activities described in the chapter **Installation and power connection** have been carried out properly.

With the exception of the chapter Switching on and off, this instruction manual contains descriptions about the mechanics of a PC 5xx/6xx select series pumping unit.

The operation of an installed vacuum regulator ⁷ and its functions are described in the instruction manual of a **VACUU·SELECT**.

5.1 Switching on

Switching on the pumping unit

Switching on

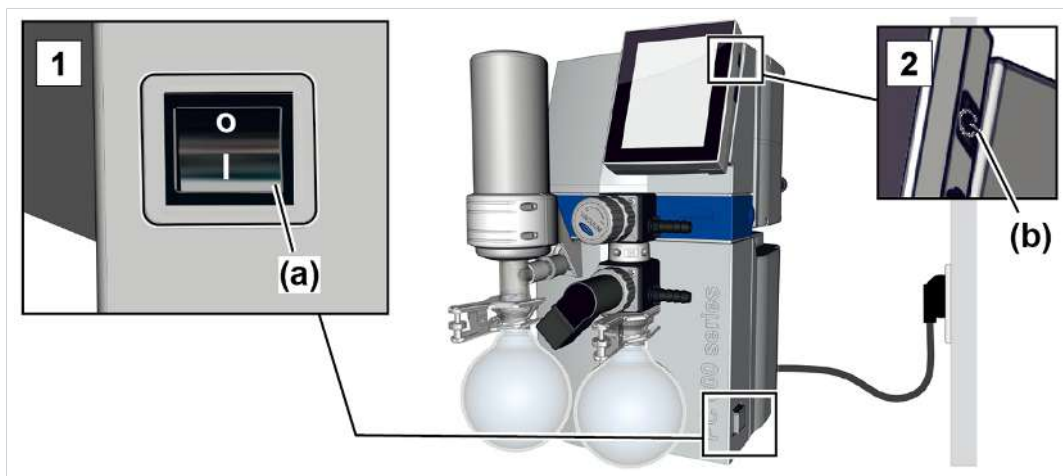

1. Switch on the rocker switch **(a)** – switch position **I**.
2. Press the ON/OFF button **(b)** on the controller.
 - ☑ Display with start screen.
 - ☑ After approx. 30 seconds, the process display appears with the control elements in the display of the controller.

⁷ WEB: [VACUUBRAND/Produkte/Messgeräte und Controller/Vakuum regeln](http://VACUUBRAND/Produkte/Messgeräte_und_Controller/Vakuum_regeln)

5.2 Operation with controller

5.2.1 Operator interface

Operator interface

VACUU-SELECT® with process display



Process display



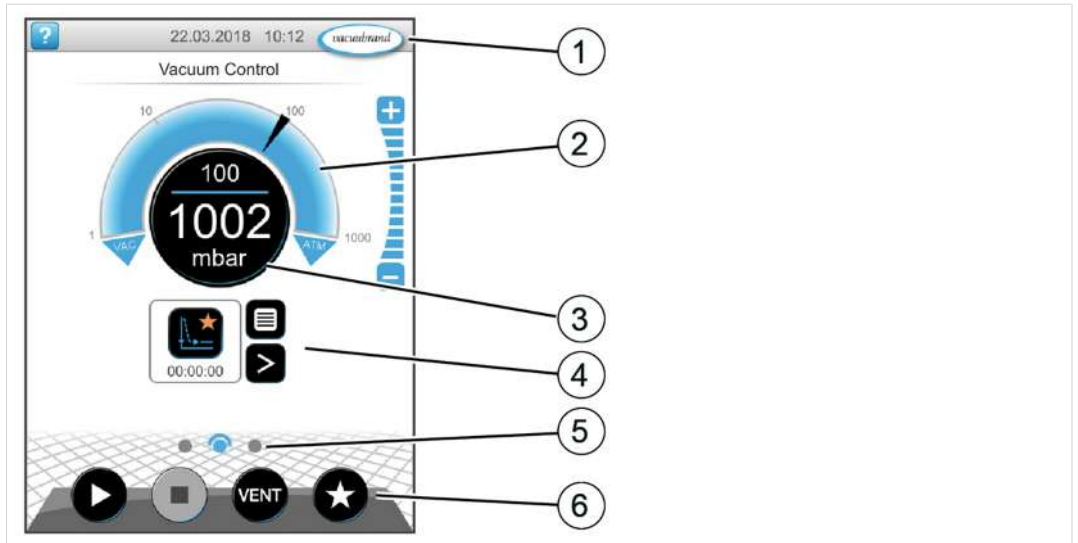





Pressure display for a process



- 1 Status bar
- 2 Analog pressure display – pressure curve
- 3 Digital pressure display – pressure value (target value, actual value, pressure unit)
- 4 Process display with context functions
- 5 Screen navigation
- 6 Controls for the controller

Controls

Controls
Vacuum controller

Button	Function
 	Start Start an application – only in the process display
 	Stop Stop an application – always possible.
	VENT⁸ – Ventilate system (Option) Button press < 2 Sec. = briefly ventilate, regulation continues.
 	Button press > 2 Sec. = ventilate to atmospheric pressure, vacuum pump is stopped. Button press during ventilation = ventilation is stopped.
 	Favorites Call up Favorites menu.



Apart from switching between two process displays, the operation of the vacuum controller is the same for all pumping units of the PC 5xx/PC6xx series.

5.2.2 User interface PC 520 or PC 620

Special feature

Two pressure curves are displayed in the process screen; pressure curves **A** and **B**, corresponding to labeling of valves A and B. This enables control of two different applications. The processes will run essentially independently of each other. Operating elements and settings are always active for the selected process.

User interface

VACUU-SELECT® with
two process screens



8 The VENT button is only shown if a ventilation valve is connected or activated.

Process screen

Pressure display for two electronically controlled processes **A** and **B**

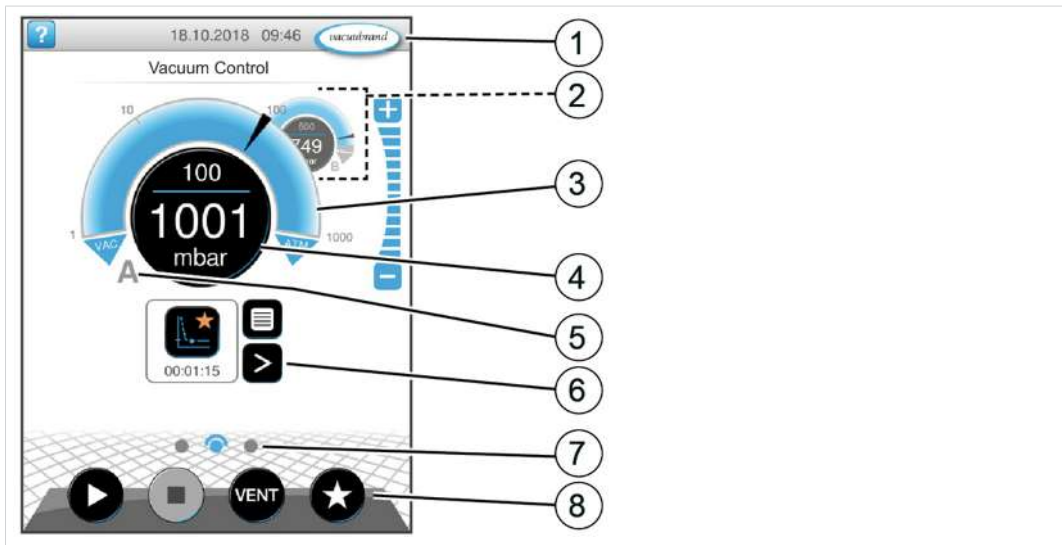

- 1 Status bar
- 2 Process screen B – in the background
- 3 Analogue pressure display – pressure curve
- 4 Digital pressure display – pressure value (target value, actual value, pressure unit)
- 5 Process screen A – in the foreground
- 6 Process screen with context features
- 7 Screen navigation
- 8 Operating elements for control

Assignment of the process screen

-> Example Assignment of process screen and valves (view of details)

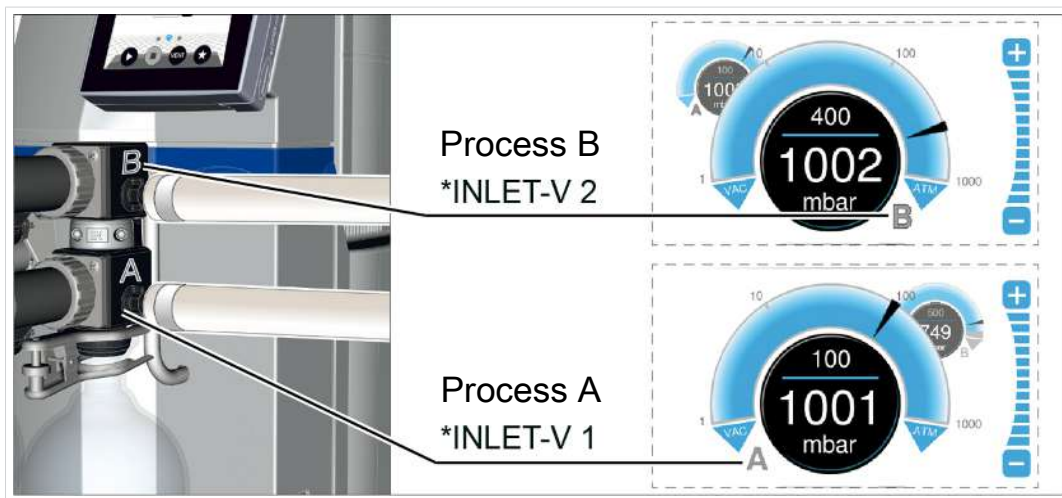

To avoid operating errors or simultaneous operation of two processes, the process screen can be switched; see:
 → **Switch the process screen from A to B on page 49** and
 → **Switch the process screen from B to A on page 50.**

Assignment VACUU·BUS addresses

VACUU·BUS addresses for processes A and B

Component	VACUU·BUS name	Address no.	
		Process A	Process B
In-line solenoid valve	INLET-V	1, 3	2, 4
Venting valve	VENT-V	1, 3	2, 4
Vacuum sensor, capacitive	VS-C	1, 3	2, 4
Pirani vacuum sensor	VS-P	1, 3	2, 4
Reference sensor	VS-REF	1, 3	2, 4



In the event of an error, only the process assigned to that component is stopped, e.g., error on VS-C 1 vacuum sensor -> Process A stops -> Error message process screen A.
All other VACUU·BUS components are global and are used by both processes, e.g., WATER-V coolant valve.

Switch the process screen from A to B

-> Example Switch from process A to process B

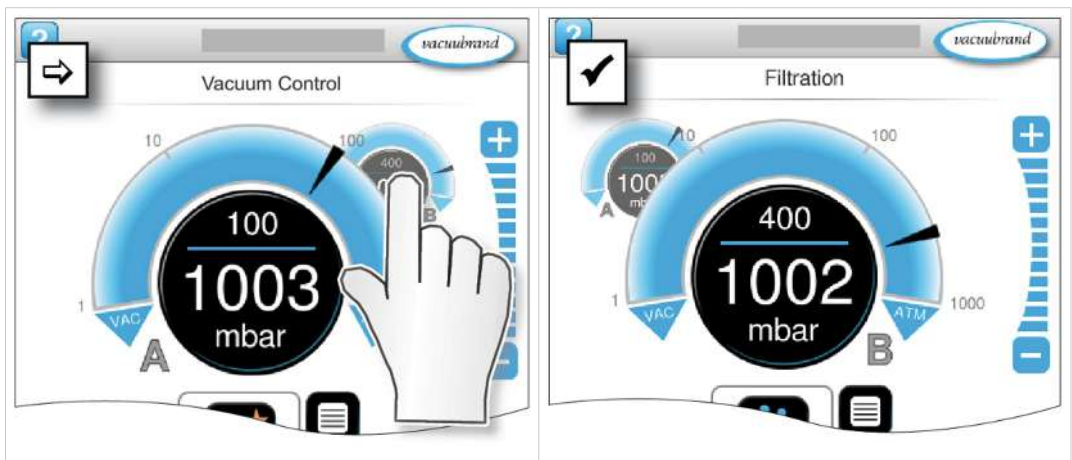

- ⇒ Tap on rear pressure curve.
 - Process B in front.
 - Operation process B enabled.
 - Operation process A locked.

Switch the process screen from B to A

-> Example
Switch from
process B to
process A

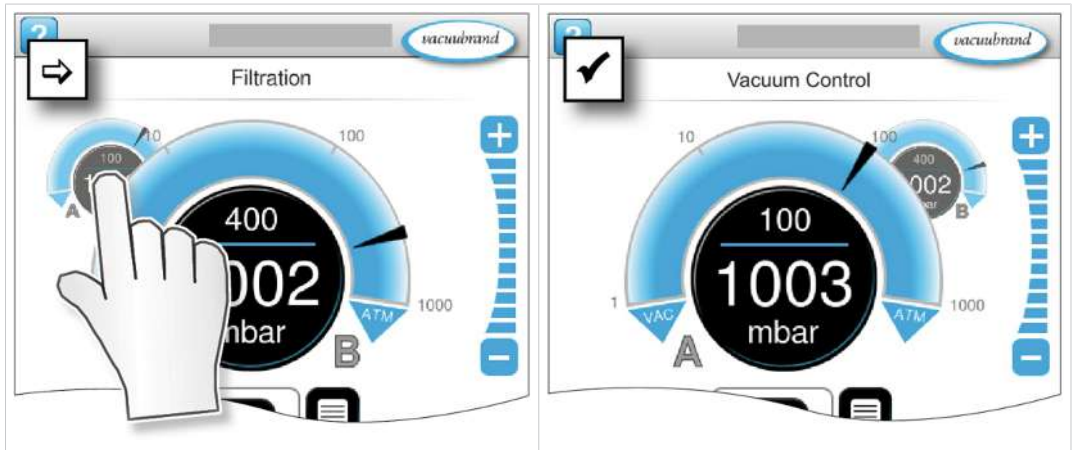

- ⇒ Tap on rear pressure curve.
 - Process A in front.
 - Operation process A enabled.
 - Operation process B locked.

5.2.3 Operation

Starting the vacuum controller

Start

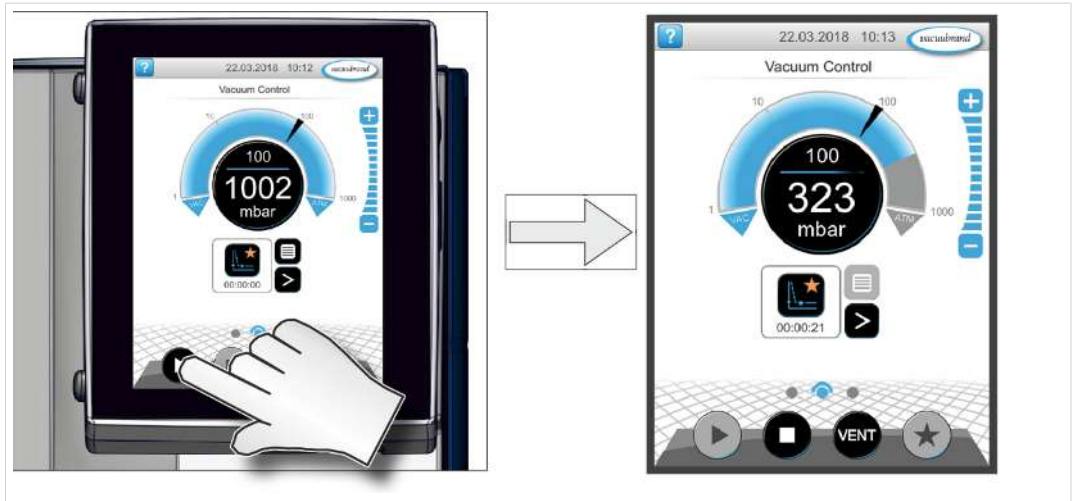
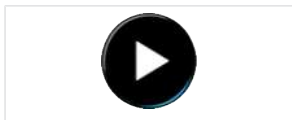

Stopping the vacuum controller

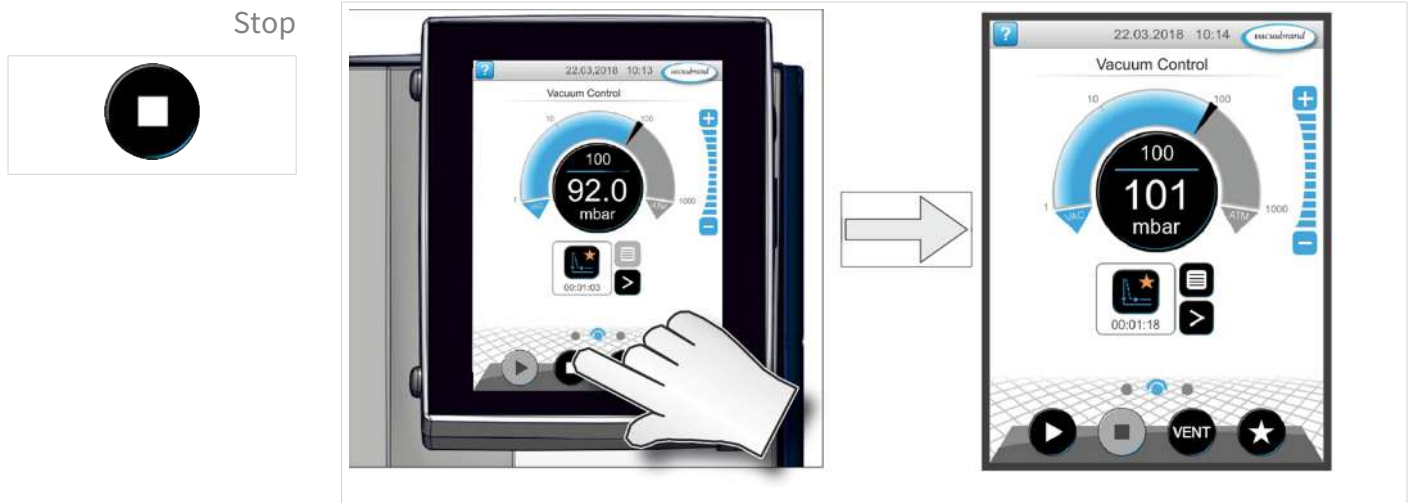

Ventilating



5.2.4 Operation with gas ballast

Meaning

The supply from the gas ballast (= gas addition) ensures that vapors are not condensed in the vacuum pump; instead, they are emitted out of the pump. This allows greater amounts of condensable vapors to be pumped, which extends the service life. The end vacuum with gas ballast is slightly higher.

Opening/closing the gas ballast valve

Operating
the gas ballast valve

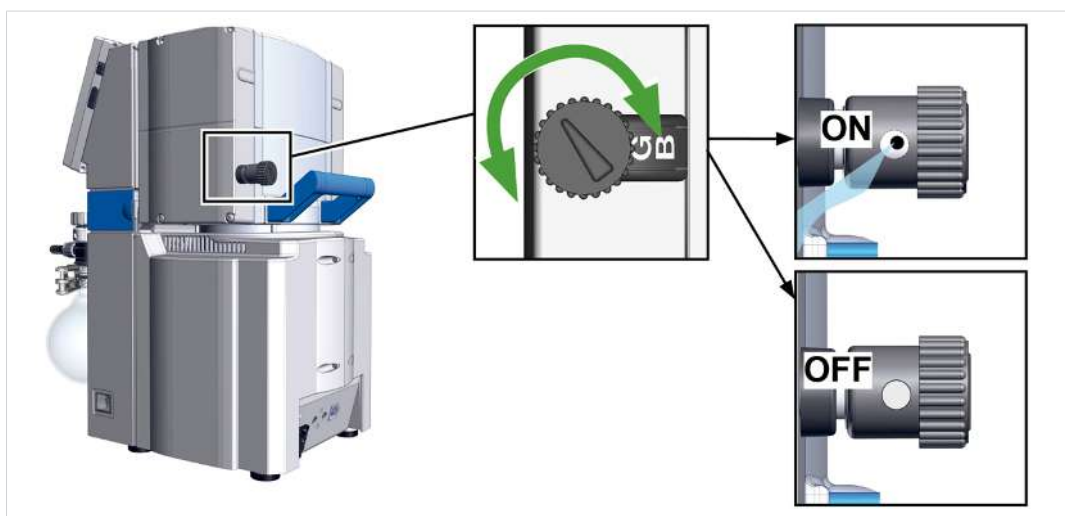

- ⇒ Turn the black gas ballast cap in any direction to open or close the gas ballast valve.
- ⇒ If possible, only evacuate the condensable vapors, e.g. water vapor, solvents, etc., when the vacuum pump is at operating temperature and the gas ballast valve is open.
- ⇒ Connect inert gas as the gas ballast to prevent and exclude the formation of potentially explosive mixtures during operation.
- ⇒ Comply with the max. permitted pressure of 1.2 bar/900 Torr abs. at the gas ballast connection.



If the gas volume in the vacuum pump is low, a gas ballast can be eliminated in these cases to increase the solvent recovery rate.

5.3 Switching off (decommissioning)

Switching off the pumping unit

Switching off, e.g. taking the pumping unit out of operation

1. Stop the process and allow the pumping unit to continue running for approx. 30 minutes with open gas ballast or open inlet (IN).
 - Condensate and residual media are rinsed out of the vacuum pump.

NOTICE! Avoid deposits and rinse the condensate out of the pump.

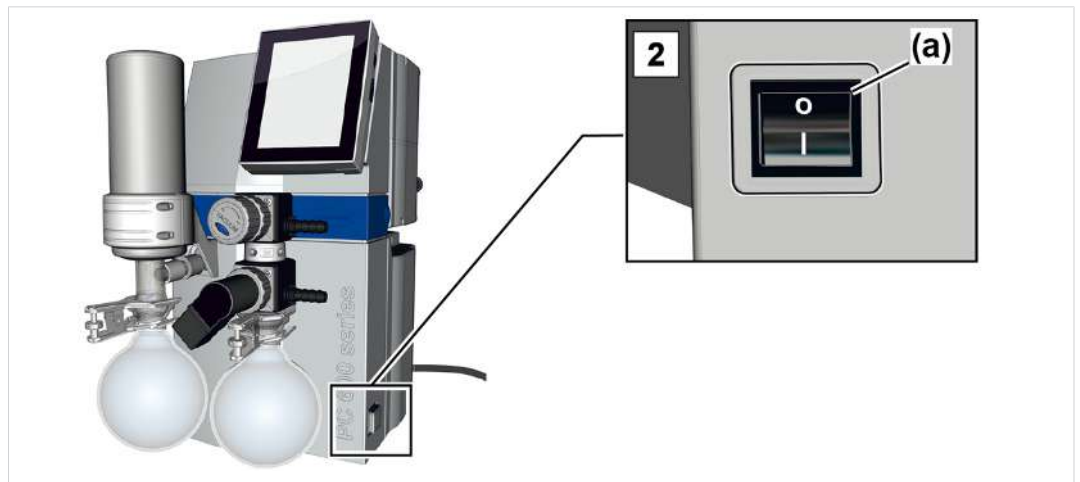

2. Switch off the rocker switch **(a)** – switch position 0.
 - Pumping unit switched off.
3. Disconnect the power plug.
4. Disconnect the pumping unit from the equipment.
5. Empty the glass flasks.
6. Check the pumping unit for any damage and soiling.

5.4 Storage

Storing the pumping unit

1. Clean the The pumping unit if it is dirty.
2. Recommendation: Carry out preventative maintenance before you put The pumping unit into storage. Especially if it has been in operation for more than 15,000 hours.
3. Seal off the suction and exhaust line, e.g. with the transport caps.
4. Pack up The pumping unit so that it is protected from dust; possibly include a drying agent.
5. Store The pumping unit in a cool and dry location.

NOTICE! If for operational reasons damaged parts are stored, these should be clearly marked as non-operational.

6 Troubleshooting

6.1 Technical assistance

To find and eliminate errors, use the table → **Error – cause – corrective measure on page 55.**

For technical assistance or in case of faults, please contact our **Service** department.



The device should only be operated in perfect technical condition.

- ⇒ Adhere to the recommended maintenance intervals to ensure a properly functioning system.
- ⇒ Send defective devices to our Service department or your specialist retailer for repairs.



6.2 Error – cause – corrective measure

Error	Cause	Corrective measure	Personnel
Measurements deviate from the reference standard	Sensor dirty. Humidity in sensor. Sensor defective. Sensor not measuring correctly.	Clean sensor measuring chamber. Allow sensor measuring chamber to dry, e.g. by draining. Calibrate sensor with reference measuring device. Replace defective components.	Qualified employee
Sensor does not transmit measurement	No voltage applied. VACUU BUS plug connection or cable defective or not inserted.	Check the VACUU BUS plug connection and cable to the controller.	Operator
Sensor does not transmit measurement	Sensor defective.	Replace defective components.	Qualified employee
Ventilation valve does not switch	No voltage applied. VACUU BUS plug connection or cable defective or not inserted. Ventilation valve dirty.	Check the VACUU BUS plug connection and cable to the controller. Clean the ventilation valve.	Operator

Error	Cause	Corrective measure	Personnel
Ventilation valve does not switch	Ventilation valve sensor defective.	Use another external ventilation valve if necessary. Replace defective components.	Qualified employee
Vacuum pump does not start	Pumping unit switched off. Power plug not connected properly or pulled out. VACUU BUS plug connection or cable defective or not inserted. Excess pressure in the exhaust line.	Switch on Pumping unit. Check the power connection and cable. Check the VACUU BUS plug connection and cable to the controller. Open the exhaust line. Ensure that nothing is blocking the line.	Operator
Vacuum pump stopped Vacuum pump does not start	Motor overloaded. Motor overheating. Thermal protection activated.	Check coolant connection. Ensure coolant supply. Allow the motor to cool down. Manually reset fault: -> Disconnect the pumping unit from the power -> Eliminate the error cause -> Restart the pumping unit	Qualified employee
No suction capacity or very little	Leak in the suction line or on the apparatus. Condensate collection bottle not installed correctly. Condensate in the vacuum pump. Open gas ballast Gas ballast cap porous or no longer present.	Check suction line and apparatus for any leaks. Check condensate collection bottle and install correctly. Check apparatus for leaks. Let the vacuum pump run for a few minutes with open suction intake port. Close gas ballast	Operator

Error	Cause	Corrective measure	Personnel
		Check the gas ballast cap. Replace defective components.	
No suction capacity or very little	Deposits in the vacuum pump. Membrane or valves defective. High amount of vapor build up in process.	Clean and test pump heads. Replace the membrane and valves. Check process parameters.	Qualified employee
No suction capacity or very little	Vacuum line too long.	Use vacuum lines with a larger cross-section.	Resp. specialist
Display off	Pumping unit switched off. Power plug not connected properly or pulled out. VACUU BUS plug connection or cable defective or not inserted. Controller switched off or defective.	Switch on Pumping unit. Check the power connection and cable. Check the VACUU BUS plug connection and cable to the controller. Replace defective components.	Operator
Condenser (cooler) defective	Mechanically damaged.	Send in.	Resp. specialist
Loud operating noises	No hose installed.	Check hose and install correctly.	Operator
Loud operating noises	Exhaust line open. Glass flask on EK missing. Membrane torn or membrane spring washer loose. Ball bearings defective.	Check exhaust line connections. Connect exhaust line to a suction or extraction system. Install glass flask Service vacuum pump and replace defective parts, or send device in for repair.	Qualified employee

7 Cleaning and maintenance

	WARNING
	Danger due to electrical voltage. <ul style="list-style-type: none">➤ Switch off the device before cleaning or maintenance.➤ Disconnect the power plug from the power outlet.
	Danger due to contaminated components. <p>When pumping dangerous media, hazardous materials can adhere to interior pump components.</p> <p>If this case applies to you:</p> <ul style="list-style-type: none">⇒ Wear your personal protective equipment, e.g. safety gloves, eye protection and, if required, a respirator.⇒ Decontaminate the vacuum pump before you open it. If required, have the vacuum pump decontaminated by an external service provider.⇒ Take safety precautions when handling hazardous materials, in accordance with your operating instructions.

NOTICE

Carrying out work in an improper manner may cause damage.

- ⇒ Have Maintenance tasks carried out by a qualified specialist or at least a trained person.
- ⇒ Before carrying out the first Maintenance, please read through all action instructions to obtain an overview of the service activities required.

7.1 Information on service activities

Recommended maintenance interval ⁹

Maintenance intervals

Maintenance intervals	As required	15,000 h
Replace membranes		x
Replace valves		x
Replace O-rings		x
Clean or replace PTFE molded hose	x	
Replace pressure release valve on EC	x	
Clean pumping unit	x	

Recommended auxiliary equipment

->Example Recommended auxiliary equipment for cleaning and maintenance



Meaning

No.	Auxiliary equipment
1	Mat for round flasks
2	Protective gloves
3	Chemical resistant container and funnel

⁹ Recommended maintenance interval according to hours of operation and under normal operating conditions; depending on the setting and field of application, we recommend carrying out cleaning and maintenance as needed.

Tools needed for maintenance

-> Example Tools



Meaning

No.	Tool	Size
1	Seal set Seal set PC 5xx #20696869 <i>or</i> Seal set PC 6xx #20696870	
2	Membrane wrench #20636554	SW66
3	Flat-nose pliers Closing hose clamps	
4	Flat-head screwdriver Opening hose clamps	Size 1
5	Hexagon socket wrench Screw fasteners for head cover Screw fasteners for EKP bracket	Size 5 Size 4
6	Torx screwdriver Screw fasteners for EK counterholder Screw fasteners for housing cover Fastening, loosening clamping brackets Screw fastener for gas ballast	TX10 TX20 TX20 TX20
7	Torque wrench, adjustable 2 –12 Nm	

7.2 Cleaning

This chapter does not describe how to decontaminate the product. Simple cleaning and care measures are described here.

⇒ Before cleaning, switch off the pumping unit.

	CAUTION
Risk of burning due to hot surfaces	
An elevated exhaust gas temperature can lead to hot surfaces on the instrument and on attached components, such as glass flasks. The temperatures that are produced during operation may cause burns.	
<ul style="list-style-type: none">➤ Use protection against accidental contact, especially when the exhaust temperature is persistently high.➤ Allow the instrument to cool before you empty the glass flask or begin performing maintenance tasks.➤ For tasks that must be performed during operation, use your personal protection equipment, e.g., heat-resistant safety gloves.	

7.2.1 Housing surface

Cleaning the surface



Clean soiled surfaces with a clean, slightly damp cloth. We recommend water or a mild soap solution to moisten the cloth.

7.2.2 Emptying the glass flask

Removing and emptying the glass flask

-> Example
Emptying the glass
flask

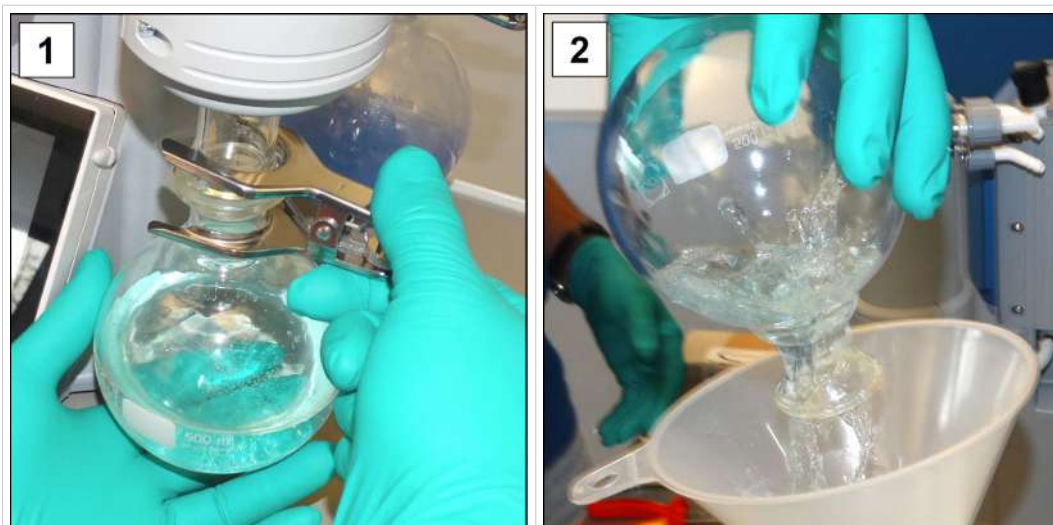

1. Open the joint clamp and remove the glass flask.
2. Empty the glass flask into a suitable container, e.g. a chemical-resistant canister.
3. Reattach the glass flask (separator) to the condenser with the joint clamp.



Depending on the application, the collected liquid can either be recycled or properly disposed of.

7.2.3 Cleaning or replacing PTFE molded hoses

Maintenance provides an opportunity to check the components of the pumping unit, including the hosing.

- ⇒ Clean the inside of highly soiled molded hoses, e.g. with a pipe cleaner or similar.
- ⇒ Replace cracked or defective molded hoses.

7.3 Vacuum pump maintenance

7.3.1 Maintenance items

Positions to be maintained

-> Example
Pump head maintenance

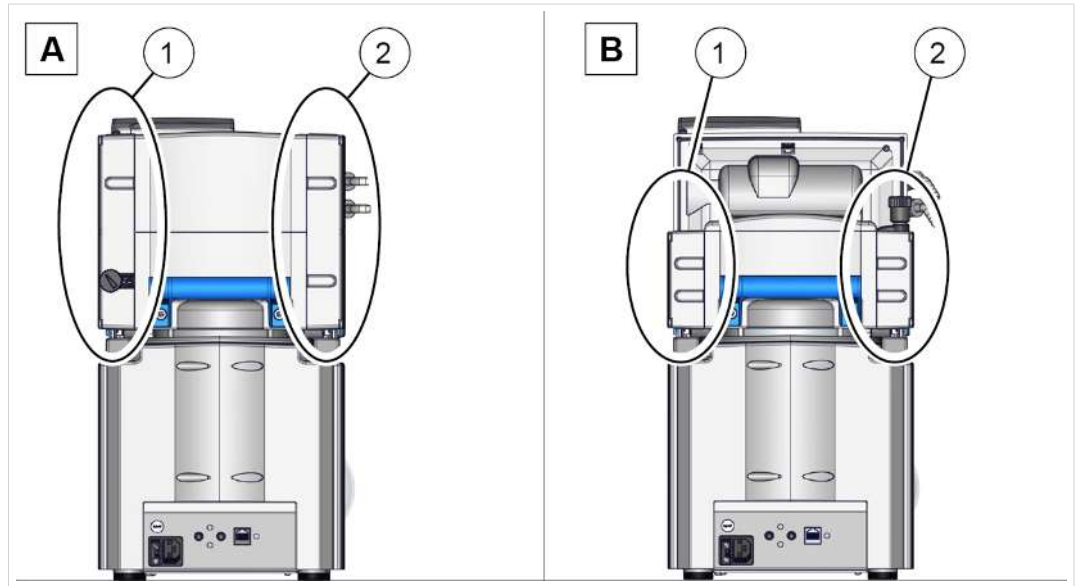

Description

Maintenance items

- 1 Pump heads, power supply side
- 2 Pump heads EK side

- ⇒ Carry out maintenance on pump heads in succession.
- ⇒ Always completely change membranes and valves on the pump heads, as described in the illustration for pump head **(1A)**.



Simple maintenance due to divided work steps.

- ⇒ First replace the membranes on one pump head pair.
- ⇒ Change the inlet/outlet valves next.
- ⇒ Then perform these tasks on the next pump head.

Exploded-view drawing of pump head (example)

-> Example
Exploded-view drawing of pump head

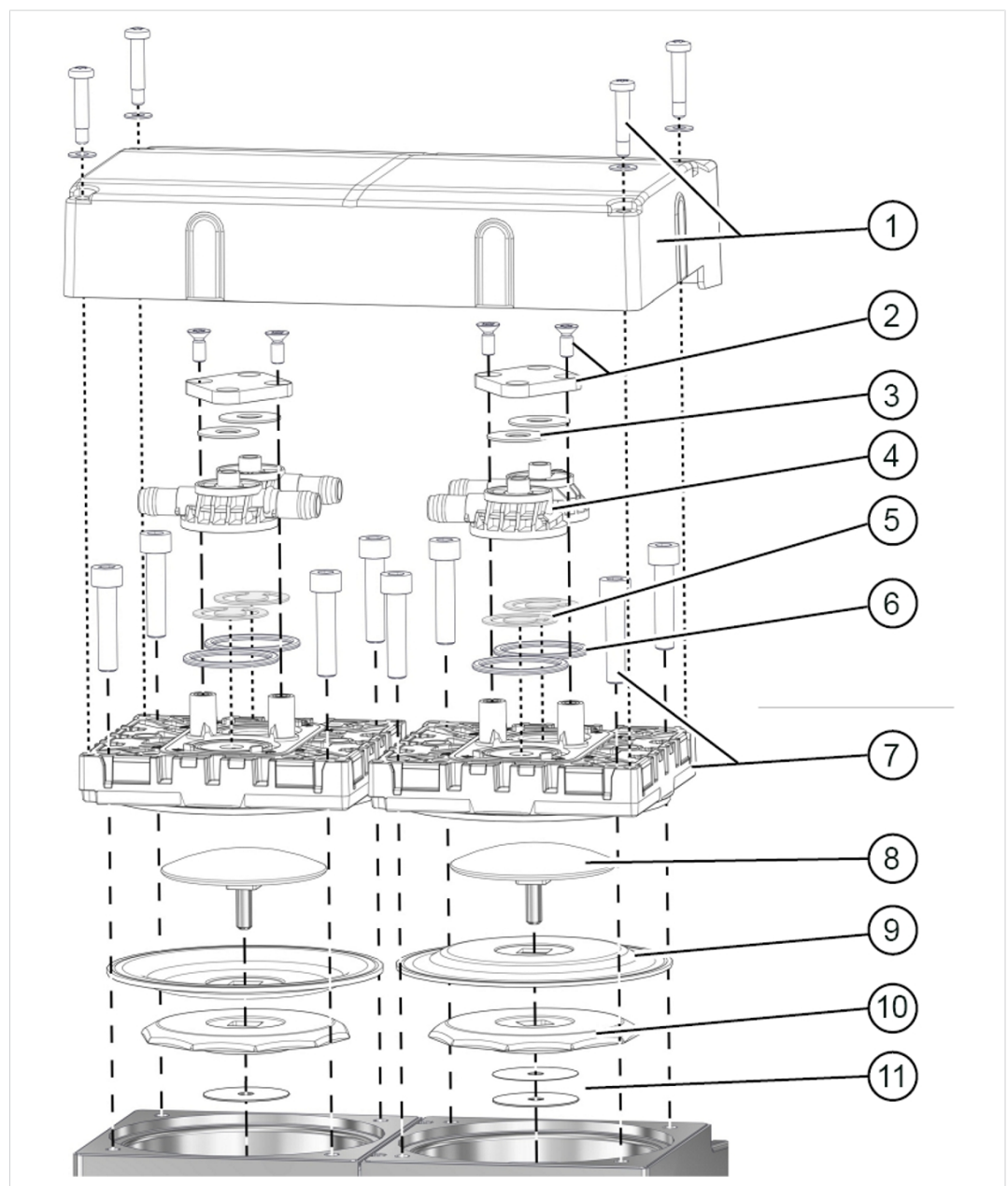

Meaning

Valve maintenance

- 1 Head cover + screw fasteners
- 2 Clamping bracket + screw fasteners
- 3 Cup springs
- 4 Valve clusters
- 5 Valves
- 6 O-rings size 26 x 2

Membrane maintenance

- 7 Head cover + screw fasteners
- 8 Membrane spring washer with square head screw

Membrane maintenance

- 9 Membrane
- 10 Membrane support disc
- 11 Spacers, max. 4 pieces per pump head

7.3.2 Changing the membranes and valves

Preparation

-> Example
Preparing for maintenance



<p>1. Switch off the pumping unit and disconnect the power plug.</p>	<p>2. Remove the glass flask and connected hoses.</p>

-> Example
Disassembling the EK (optional)

<p>3. Undo the screws from the counterholder; Torx screwdriver TX10.</p>	<p>4. Remove the counterholder and set it aside together with the screws.</p>

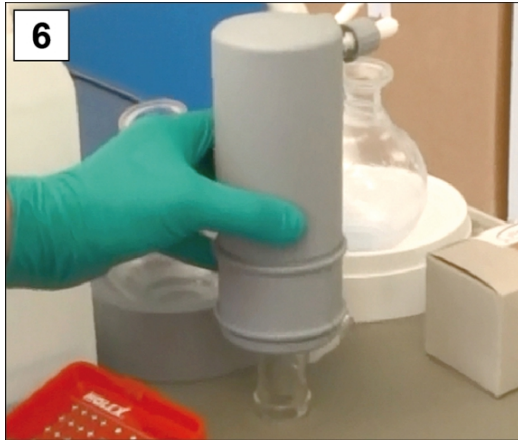
	
<p>5. Unscrew the cap nut, pull off the molded hose and remove the cooler.</p>	<p>6. Put the cooler down safely so that no liquid can leak out.</p>
<ul style="list-style-type: none">■ Here you can check the pressure release valve of the EK and replace it in case of damage.	

Dismantling device and housing parts

-> Example
Dismantling housing
parts, left side



1. Undo the screw fasteners from the head cover; Torx screwdriver TX20.



2. Remove the head cover and set it aside.



3. Open the hose clamps of the outer hoses. Flat-head screwdriver size 1.

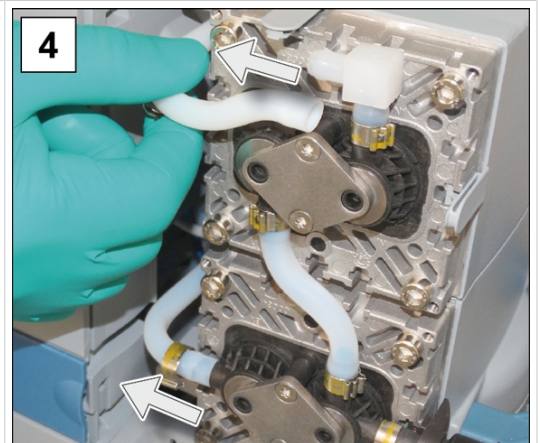

4. Pull the molded hoses off.

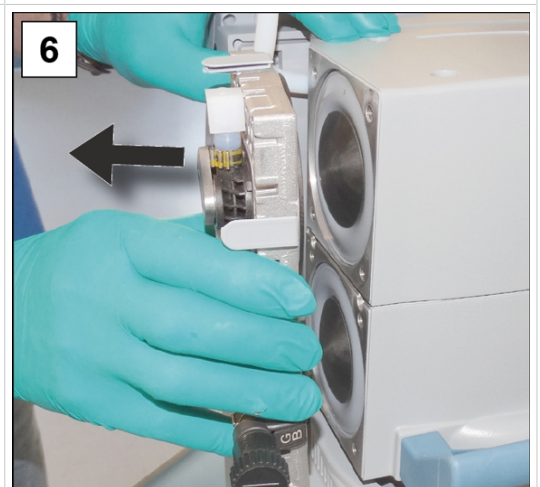

5. Unscrew the hexagon socket screws from the head covers. Hexagon socket wrench size 5.

6. Set the screw fasteners aside and take off the pump head pair.

Replacing membranes

-> Example
Membrane replacement



1. Gently press against one of the membrane spring washers.

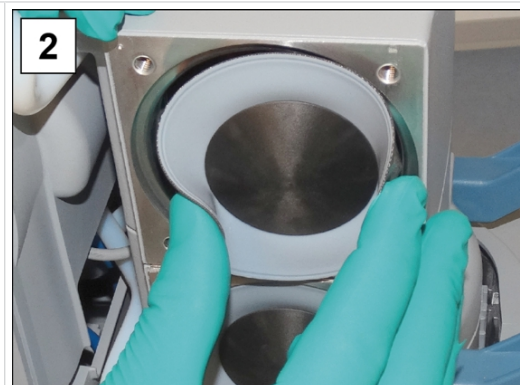

2. Fold the membrane forward on the sides.

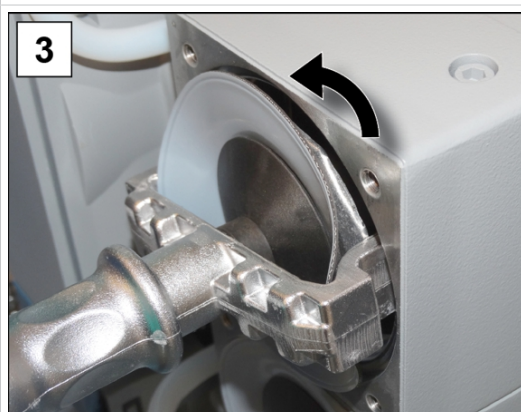

3. Carefully position the membrane wrench onto the membrane support disc and unscrew the assembly with the membrane wrench fixed in place.

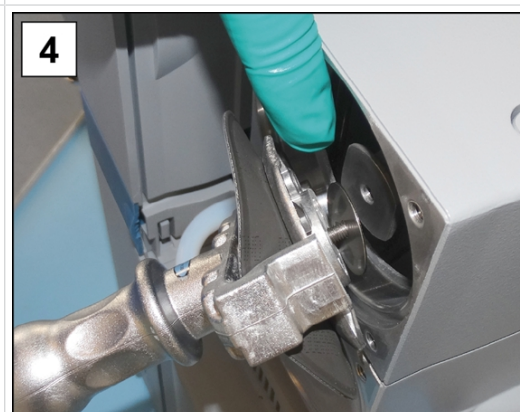

4. Lift the membrane with all its parts out of the vacuum pump. If spacers are stuck to the connecting rod, carefully remove these.

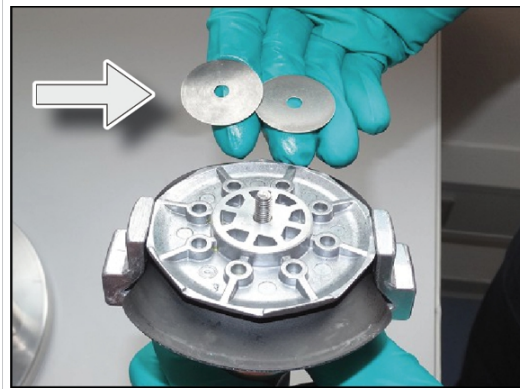

- Do not let any spacers fall into the aluminum housing.
- Make sure there are no spacers stuck to the connecting rod.
- Keep the spacers for later use. It is imperative that these are re-installed in the same quantity.

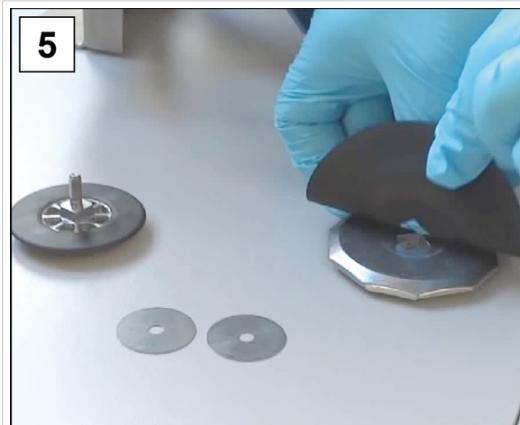

5. Pull the membrane spring washer out and remove the used membrane.

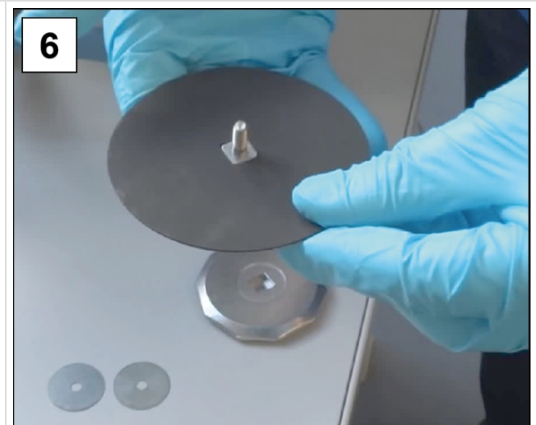

6. Place the new membrane onto the square bolt of the membrane spring washer.

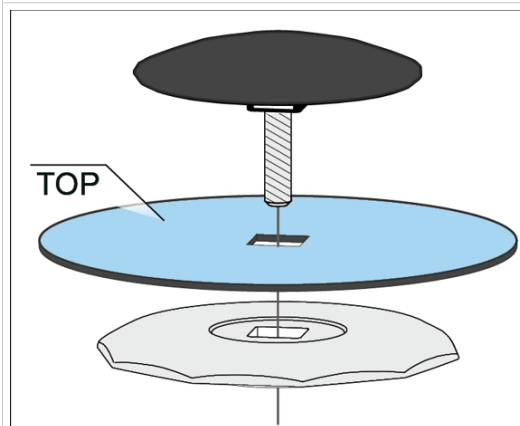

- Make sure that you install the membrane correctly, with the coated, light side on top.
- Ensure that it is correctly positioned on the square bolt.



7. Place all spacers onto the threaded bolt.



8. Attach the membrane assembly in the membrane wrench.



9. Hold onto the spacers and carefully place all components into the threaded hole of the connecting rod.



10. Tighten the assembly by hand at first using the membrane wrench.



11

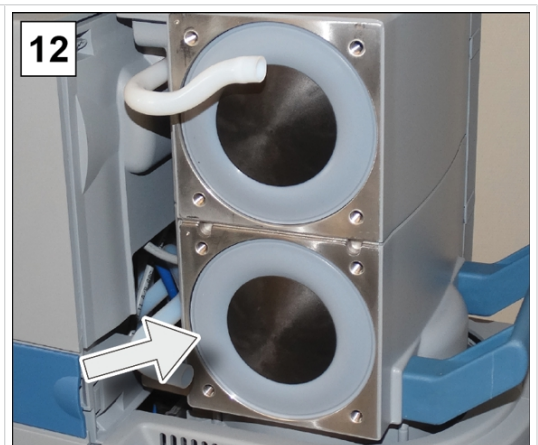

12

11. Then place a torque wrench with a hexagon socket bit onto the membrane wrench and tighten the assembly to 6 Nm.

12. Repeat the steps for changing the second membrane.

Replacing valves

-> Example
Valve change

Fig. 2-4 optional description, only applies to pump head with gas ballast GB

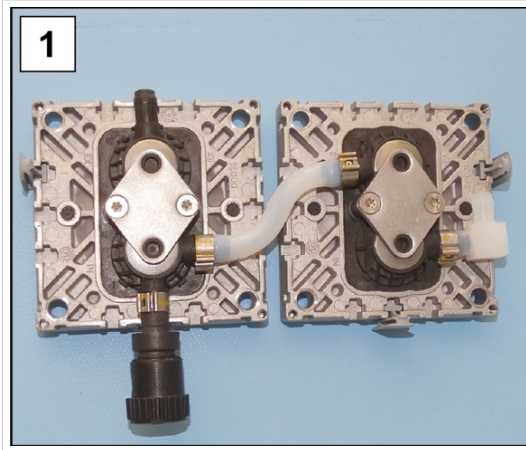
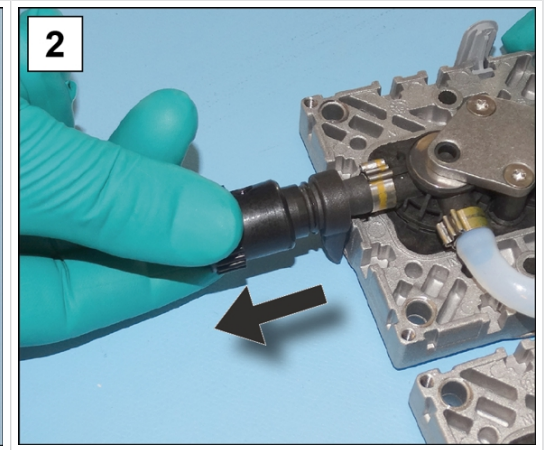
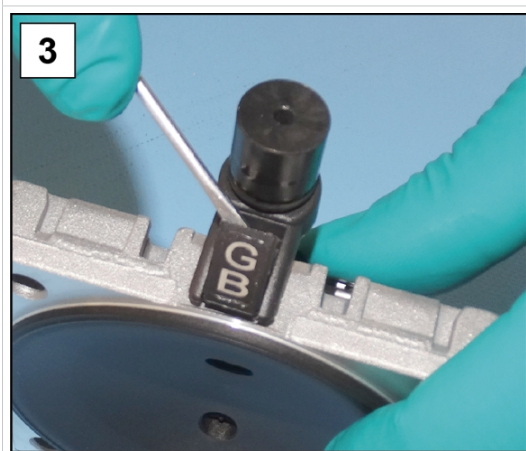
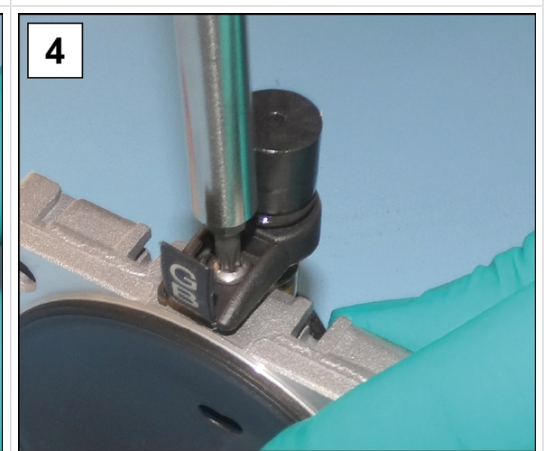
	
<p>1. Take the pump head pair that was set aside.</p>	<p>2. Pull off the gas ballast cap.</p>
	
<p>3. Carefully pry open the cover.</p>	<p>4. Undo the screw fastener; Torx screwdriver TX20.</p>

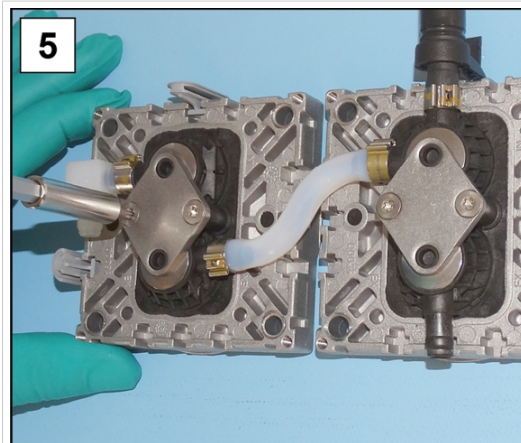

5. Undo the Torx screws on the clamping brackets; Torx screwdriver TX20.

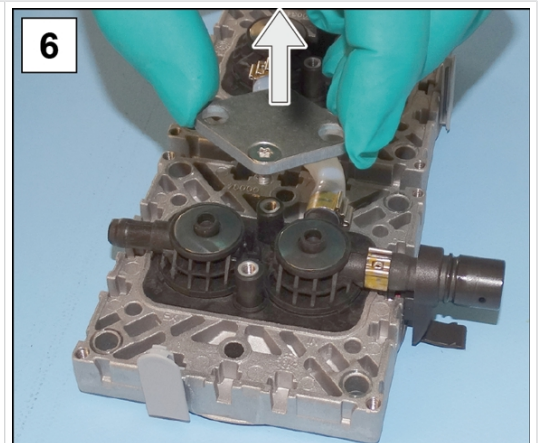

6. Remove the clamping brackets from the valve clusters.

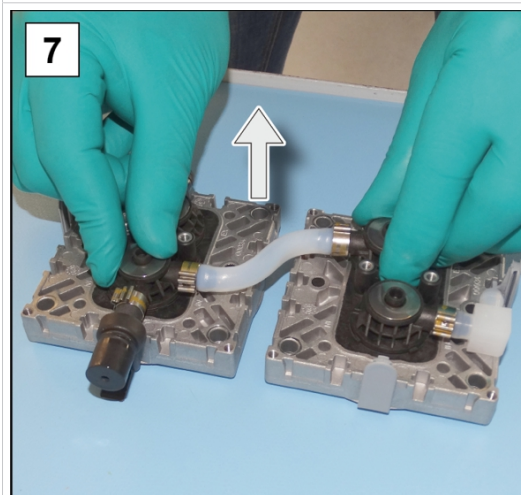

7. Remove the valve clusters with the cup springs.



Top view: Components valve clusters, valves and pump head pair.

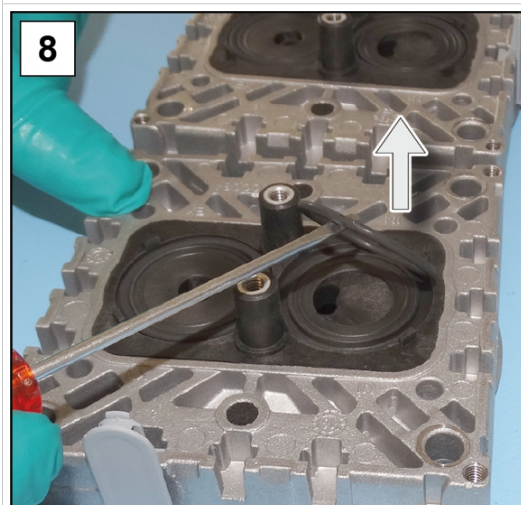

8. Carefully remove the used O-rings and valves.

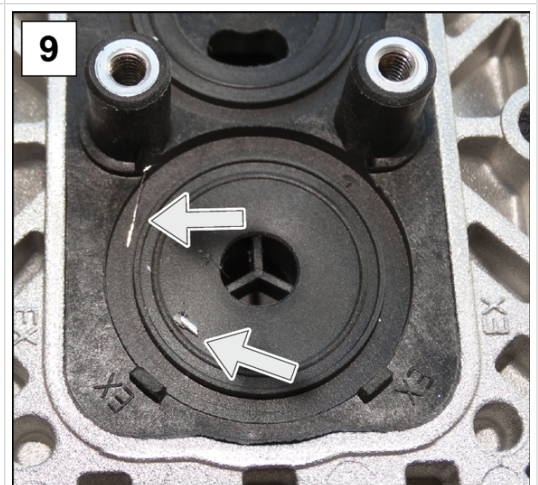

9. Check the surfaces for soiling.

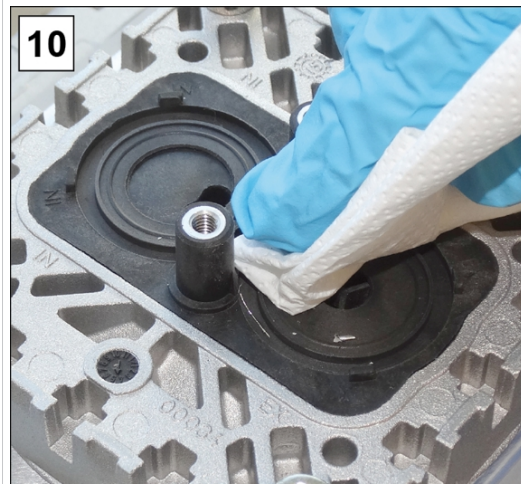

10. Carefully clean dirty surfaces.

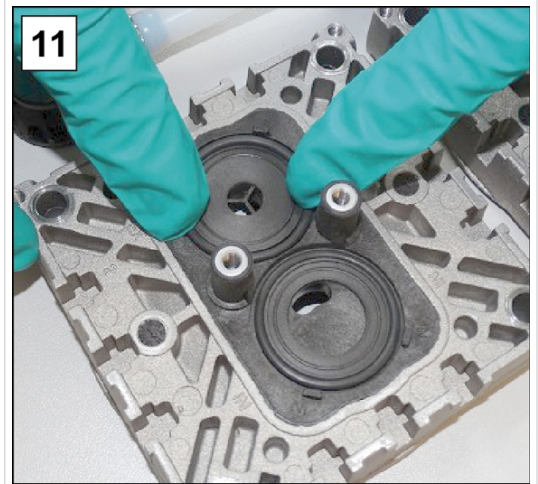

11. Insert new sealing rings into the notches.

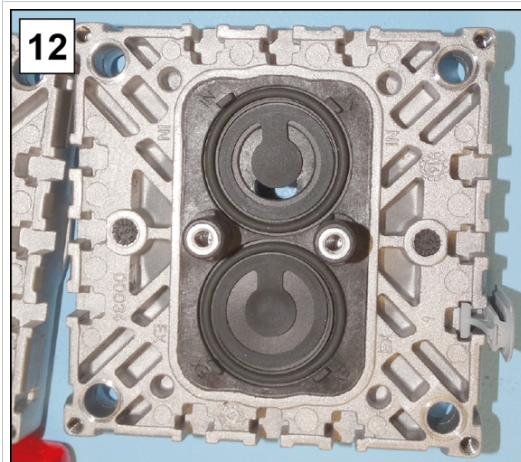

12. Apply the new valves and align them.

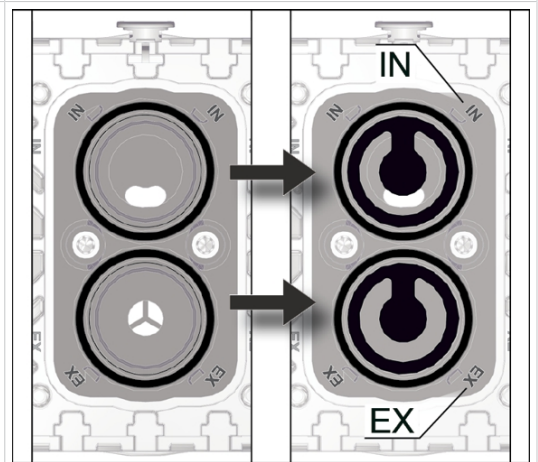

Top view detail: Correct positioning of the valves.

IN = Inlet (Inlet)

EX = Exhaust (Outlet)

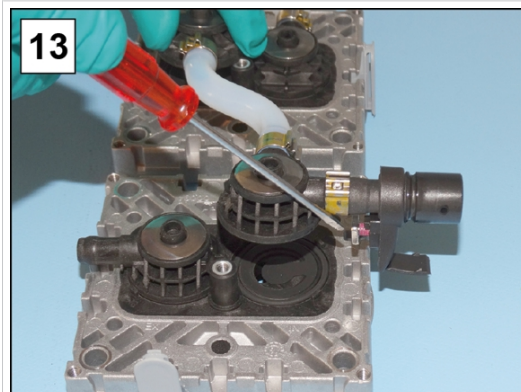

13. Place both valve clusters with the cup springs onto the pump heads.

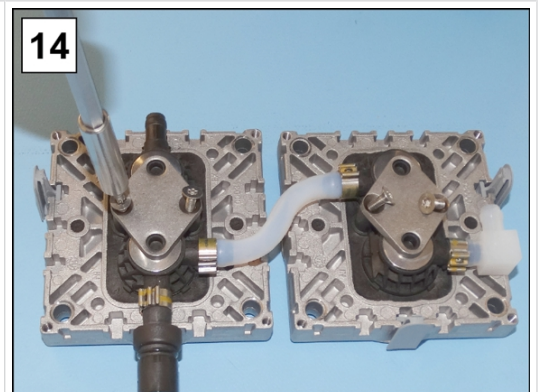

14. Place the clamping brackets on the valve clusters and tighten the screw fasteners by hand.

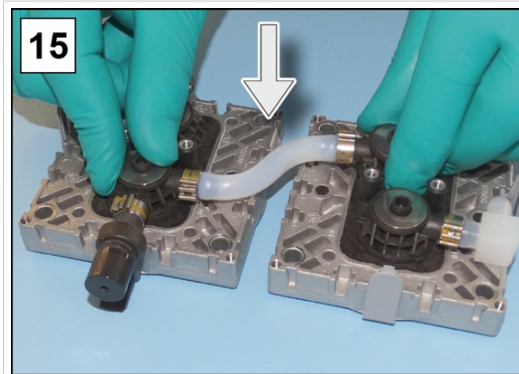

15. Place both valve clusters with the plate washers onto the pump heads.

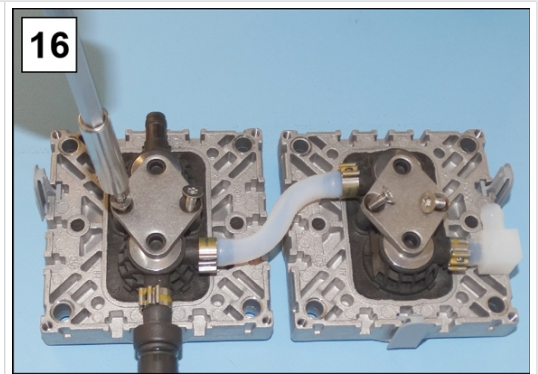

16. Place the clamping brackets on the valve clusters and tighten the screw fasteners by hand.

Assembling device and housing parts

Before you put the pumping unit back into operation, all device and housing parts that were removed must first be re-attached.

-> Example
Assembling device
and housing parts



1. Carefully press the membranes centrally and flush into the housing opening.



2. Hold the pump head pair on the vacuum pump and tighten the screw fasteners; hexagon socket wrench size 5.

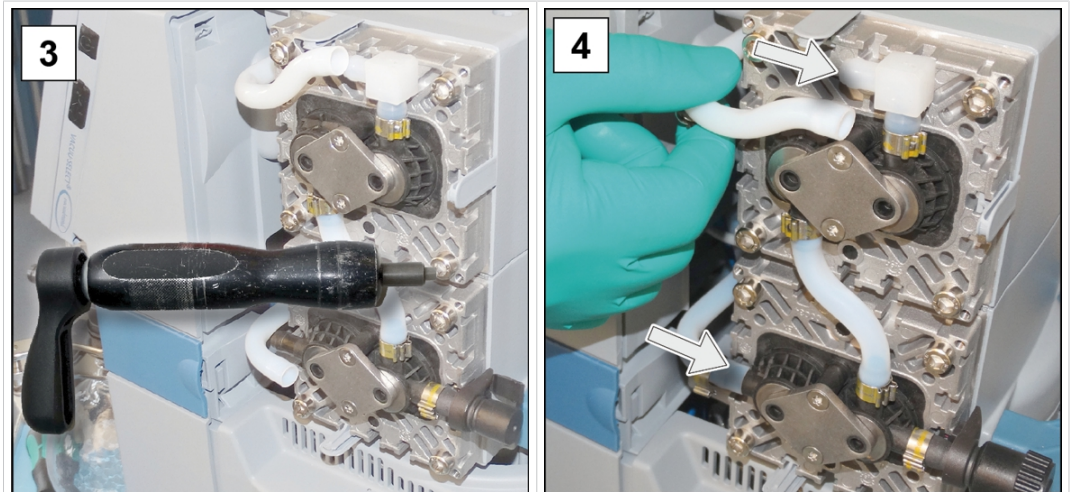

3. Tighten the screw fasteners crosswise to 12 Nm with a torque wrench.

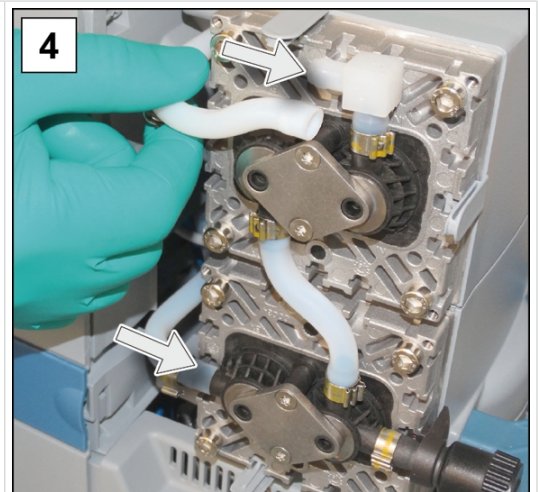

4. Slide the molded hoses back onto the connections.

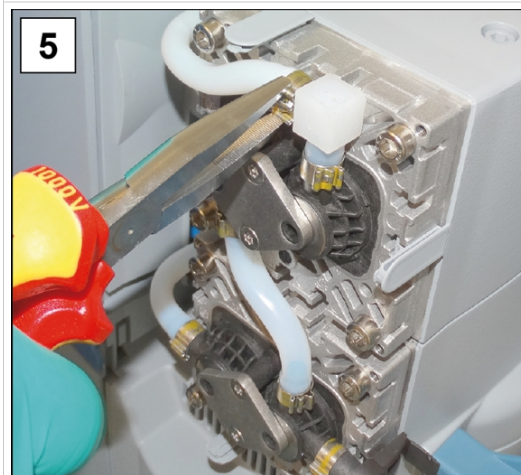

5. Close the hose clamps on the hose nozzles, e.g. with flat nose pliers.

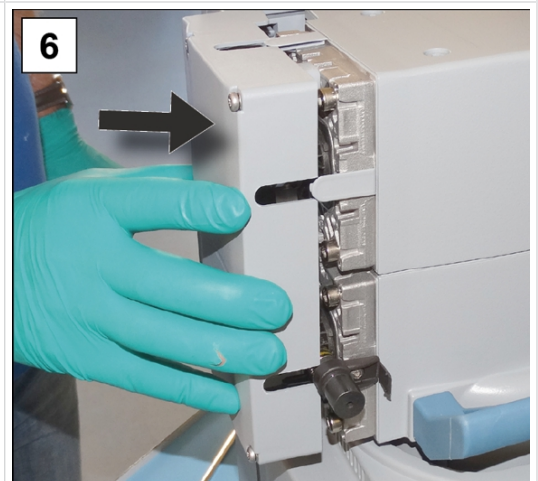

6. Put on the head cover so that it fits.

Fig. 8 optional description, only applies to pump head with gas ballast GB

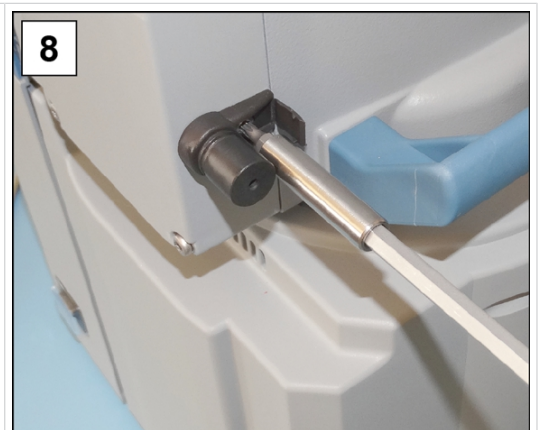

- | | |
|--|---|
| 7. Tighten the screw fasteners of the head cover; Torx screwdriver TX20. | 8. Tighten the screw fastener and close the cover; Torx screwdriver TX20. |
|--|---|

Changing the membranes and valves of the next pump head

- ⇒ Turn the pumping unit to the other side.
- ⇒ Repeat the steps of the previous description for changing the membrane and valve.

If the maintenance work is fully completed:



- ⇒ Connect the hosing for operation.
- ⇒ Connect the pumping unit to the power supply.
 - Pumping unit ready for restart.
 - Without reconnection -> Pumping unit prepared for storage.

7.3.3 Replacing a device fuse

At the power connection, on the back side of the pumping unit, there are 2 device fuses, type: 6.3 AT 5x20.

Changing a device fuse

-> Example
Checking and replacing a device fuse

	
1. Disconnect the power plug.	2. Carefully pull out the fuse holder.

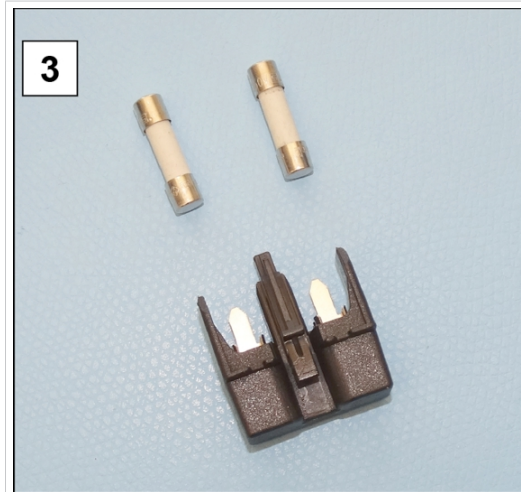

3. Replace defective fuses.

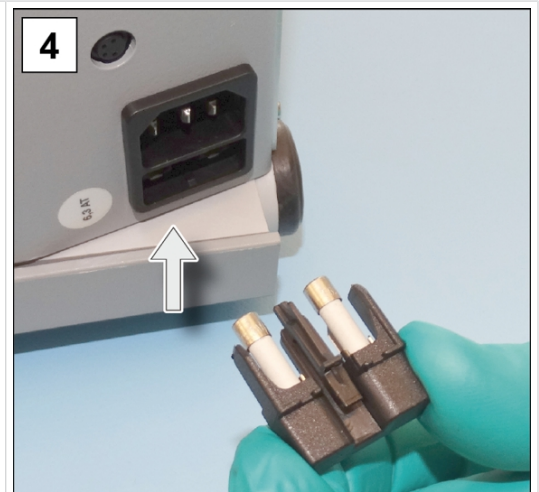

4. Slide the fuse holder back onto the fuse socket.

8 Annex

8.1 Technical data

Product designation
Product names

Chemistry pumping unit series

PC 510 select	PC 610 select
PC 511 select	PC 611 select
PC 520 select	PC 620 select

Technical data

Technical data

Ambient conditions

		(US)
Ambient temperature	10–40 °C	50–104 °F
Installation height, max.	2000 m above sea level	6562 ft above sea level
Humidity	30–85 %, non-condensing	
Degree of contamination	2	
Impact energy	5 J	
Protection class (IEC 60529)	IP 20	
Protection class (UL 50E)	Type 1	
Avoid condensate or contamination from dust, liquids and corrosive gases.		

Operating conditions

		(US)
Operating temperature	10–40 °C	50–104 °F
Storage/transport temperature	-10–60 °C	14–140 °F
Maximum permissible media temperature (gas) of non-explosive atmospheres:		
short-term	80 °C	176 °F
Continuous operation	40 °C	104 °F
ATEX conformity	II 3/- G Ex h IIC T3 Gc X Internal Atm. Only Tech. File: VAC-EX02	
Maximum permissible media temperature (gas) of  atmospheres:		
short-term	40 °C	104 °F
Continuous operation	40 °C	104 °F

Connections

Vacuum, inlet IN	Hose nozzle DN 8/10
Gas ballast GB	Gas ballast valve, manual
Inert gas adapter – OPTION	Small flange GB NT KF DN 16

	Hose nozzle GB NT DN 6-10		
Venting valve (venting with inert gas) – OPTION	Silicone rubber hose 3-6		
Coolant EK	2x hose nozzles DN 6-8		
Exhaust gas, outlet EX	Hose nozzle DN 8/10		
Cold connector	+ power connection CEE, CH, CN, UK, IN, US		
Plug-in connector	VACUU·BUS®		
Electrical data	(US)		
Nominal voltage	230 VAC ±10 %	100-115 VAC ±10 %	120 VAC ±10 %
Nominal frequency	50/60 Hz	50/60 Hz	60 Hz
Rated speed	1500/ 1800 min ⁻¹	1500/ 1800 rpm	1800 rpm
Nominal current PC5xx	1,8 A	3.4 A	2.9 A
Nominal power PC5xx	0,18 kW	0.24 hp	0.24 hp
Nominal current PC6xx	3,0 A	5.7 A	4.0 A
Nominal power PC6xx	0,25 kW	0.34 hp	0.34 hp
Overvoltage category	II		
Interface	VACUU·BUS®		
Power cord	2 m		
Device fuse 2x	6,3 AT 5x20		
Vacuum data	(US)		
Inlet pressure / outlet pressure / differential pressure, absolute	1.1 bar	825 Torr	
Pressure at gas connections, absolute max.	1.2 bar	900 Torr	
Sensor	integrated	integrated	
Measurement principle	Ceramic membrane (aluminum oxide), capacitive, gas-type independent, absolute pressure		
Measurement accuracy	±1 mbar/hPa/Torr, ±1 digit (after adjustment, constant temperature)		
Upper measurement limit	1080 mbar	810 Torr	
Lower measurement limit	0.1 mbar	0.1 Torr	
Temperature drift	< 0.15 mbar/K	0.11 Torr/K	
PC 510/511/520			

Pumping speed, max.	2.0 m ³ /h	1.2 cfm
End vacuum, absolute	7 mbar	5 Torr
End vacuum with GB, absolute	12 mbar	9 Torr
Number of cylinders/steps	2/2	
PC 610/611/620		
Pumping speed, max.	3.4 m ³ /h	2.2 cfm
End vacuum, absolute	1.5 mbar	1.1 Torr
End vacuum with GB, absolute	3 mbar	2.2 Torr
Number of cylinders/steps	4/3	
Weights* and dimensions (l x w x h)		(US)
PC 510 select	418 mm x 272 mm x 457 mm	16.5 in x 10.7 in x 18.0 in
Weight*	17,9 kg	39.5 lb
PC 511 select	435 mm x 272 mm x 457 mm	17.1 in x 10.7 in x 18.0 in
Weight*	18,1 kg	39.9 lb
PC 520 select	435 mm x 272 mm x 457 mm	17.1 in x 10.7 in x 18.0 in
Weight*	18,4 kg	40.6 lb
PC 610 select	419 mm x 243 mm x 457 mm	16.5 in x 9.6 in x 18.0 in
Weight*	20,4 kg	45 lb
PC 611 select	435 mm x 243 mm x 457 mm	17.1 in x 9.6 in x 18.0 in
Weight*	20,6 kg	45.4 lb
PC 620 select	435 mm x 243 mm x 457 mm	17.1 in x 9.6 in x 18.0 in
Weight*	20,6 kg	45.4 lb
* without cable		
Other information		
Sensor type	VACUU·SELECT Sensor	
Controller	VACUU·SELECT	
Volume of separator flask	500 ml each	
Sound pressure level	45 dBA	

8.2 Wetted materials

Wetted materials

Component	Wetted materials
Pump	
Head cover	ETFE carbon fiber reinforced
Diaphragm clamping disc	ETFE carbon fiber reinforced
Diaphragms	PTFE
Valves	FFKM
O-rings	FKM
Valve terminal	ECTFE, carbon fiber reinforced
Gas ballast pipe	Carbon fiber reinforced PTFE
Elbow (at valve terminal)	ETFE/ECTFE
Pumping unit	
Inlet	PBT or PP
Outlet	PET
Distributor head (inlet PC 510/610)	PPS glass fiber reinforced
Valve block (inlet PC 511/520/611/620)	PP
Flow control diaphragm (PC 511/611)	PTFE
Housing (solenoid valve)	PVDF / PE / PPS
Valve plate (solenoid valve)	Fluoroelastomer
O-ring on separator	Fluoroelastomer
Pressure relief valve at the vapor condenser	Silicone rubber, PTFE film
Vapor condenser	Borosilicate glass
Round bottom flask	Borosilicate glass
Hoses	PTFE
Hose fitting	ETFE, ECTFE
O-ring on separator	Fluoroelastomer
Peltronic vapor condenser	ETFE, ECTFE, PP, PA
Silencer OPTION	PBT, PVF, rubber
VACUU-SELECT Sensor	
Vacuum sensor	Aluminum oxide ceramic, gold-coated
Measuring chamber	PPS
Small flange OPTION	PP
Seal on sensor	Chemical-resistant fluoroelastomer
Hose nozzle	PP

Seal on ventilation valve

FFKM

8.3 Rating plate

Specifications from
the type plate



- ⇒ In case of error, take note of the type and serial number from the type plate.
- ⇒ When contacting our service department, provide the type and serial number from the type plate. This way we can provide you with targeted support and consultation for your product.

Pumping unit type plate, general

-> Example
Type plate details

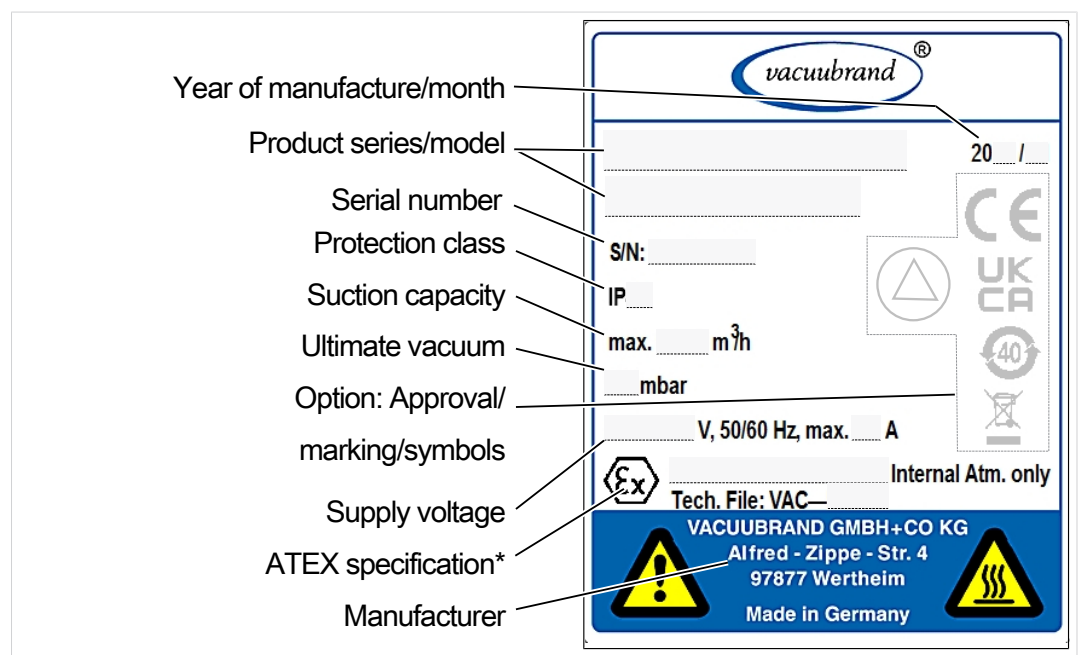

* Specification of the documentation, group and category, marking G (gas), ignition protection type, explosion group, temperature class (see also: Approval ATEX device category).

8.4 Order data

Ordering information
for pumping units

Chemistry pumping unit series	*Order no.
PC 510 select	2073315x
PC 511 select	2073325x
PC 520 select	2073335x
PC 610 select	2073715x
PC 611 select	2073725x
PC 620 select	2073735x

** Order no. depends on power cord CEE, CH, UK, US, CN, IN*

Order data acces-
sories

Accessories	Order No.
Vacuum hose DN 6 mm (l = 1000 mm)	20686000
Vacuum hose DN 8 mm (l = 1000 mm)	20686001
Coolant valve VKW-B	20674220
Ventilation valve VBM-B	20674217
Level sensor	20699908
VACUU·SELECT Sensor	20612881
VSK 3000	20640530
DAkKS calibration with first delivery	20900214
DAkKS recalibration	20900215

Order data replace-
ment parts

Replacement parts	Order No.
Hose nozzle 6 curved	20639948
Hose nozzle DN 6/10	20636635
Small flange KF DN 16	20635008
Extension cable VACUU·BUS, 0.5 m	20612875
Extension cable VACUU·BUS, 2 m	20612552
Extension cable VACUU·BUS, 10 m	22618493
Spherical joint clamp VA KS35/25	20637627
Glass flask/round flask 500 ml	20638497
PA knurled nut M14x1 (union nut)	20637657
PA clamping ring D10 (seal)	20637658
Emissions condenser EK, complete	On request
Dry ice condenser TE	On request
Immissions condenser IK	On request
Peltronic emissions condenser EKP	20636298

Anti-rotation protection D17x17.5		20635113
Gas ballast cap		20639223
Power cable	CEE	20612058
	CH	20676021
	CN	20635997
	IN	20635365
	UK	20612065
	CEE	20612058



⇒ VACUUBRAND > Support > Repair instructions > [Chemistry pumping units](#).

Supply sources

International agents
and dealers

Purchase original accessories and original replacement parts from a branch office of VACUUBRAND GMBH + CO KG or from your local dealer.



- ⇒ Information about the complete range of products can be found in the current product catalog.
- ⇒ Your local dealer or VACUUBRAND [sales office](#) is available for orders, questions about vacuum regulation and the ideal accessories.

8.5 Service information

Use the comprehensive range of services of **VACUUBRAND GMBH + CO KG**.

Detailed overview of services

Range of services

- Product consultation and practical solutions,
- Quick delivery of replacement parts and accessories,
- Professional maintenance,
- Prompt repair process,
- On-site service (on request),
- Calibration (DAkkS accreditation),
- With clearance certificate: Returns, disposal.

Additional information can be found on our website: www.vacuubrand.com.

Service procedure

Follow the description at: VACUUBRAND > Support > [Service](#)



Reduce downtimes, speed up processing. When contacting our service department, please have the required information and documents ready.

- ⇒ Your order can be assigned quickly and easily.
- ⇒ Risks can be excluded.
- ⇒ A short description, photos or diagnostics data help to narrow down the error.

8.6 EU declaration of conformity

EG-Konformitätserklärung für Maschinen EC Declaration of Conformity of the Machinery Déclaration CE de conformité des machines



Hersteller / Manufacturer / Fabricant:

VACUUBRAND GMBH + CO KG · Alfred-Zippe-Str. 4 · 97877 Wertheim · Germany

Hiermit erklärt der Hersteller, dass das Gerät konform ist mit den Bestimmungen der Richtlinien:

Hereby the manufacturer declares that the device is in conformity with the directives:

Par la présente, le fabricant déclare, que le dispositif est conforme aux directives:

- 2006/42/EG
- 2014/30/EU (nur / only / seulement VACUU-SELECT)
- 2014/34/EU
- 2011/65/EU, 2015/863

Chemie-Pumpstand / Chemistry pumping unit / Groupe de pompage « chimie »:

Typ / Type / Type: **PC 510 select / PC 511 select / PC 520 select / PC 610 select / PC 611 select / PC 620 select**

Artikelnummer / Order number / Numéro d'article: **20733150, 20733151, 20733152, 20733156, 20733157 / 20733250, 20733251, 20733252, 20733256, 20733257 / 20733350, 20733351, 20733352, 20733356, 20733357 / 20737150, 20737151, 20737152, 20737156, 20737157 / 20737250, 20737251, 20737252, 20737256, 20737257 / 20737350, 20737351, 20737352, 20737356, 20737357**

Seriennummer / Serial number / Numéro de série: Siehe Typenschild / See rating plate / Voir plaque signalétique

Angewandte harmonisierte Normen / Harmonized standards applied / Normes harmonisées utilisées:

DIN EN ISO 12100:2011, DIN EN 1012-2:2011, DIN EN 61010-1:2020,

IEC 61010-1:2010 + COR:2011 + A1:2016, modifiziert / modified / modifié + A1:2016/COR1:2019

DIN EN 61326-1:2013 (nur / only / seulement VACUU-SELECT)

DIN EN 1127-1:2019; DIN EN ISO 80079-36:2016

DIN EN IEC 63000:2019

Bevollmächtigter für die Zusammenstellung der technischen Unterlagen / Person authorised to compile the technical file / Personne autorisée à constituer le dossier technique:

Dr. Constantin Schöler · VACUUBRAND GMBH + CO KG · Germany

Ort, Datum / place, date / lieu, date: Wertheim, 07.12.2022

(Dr. Constantin Schöler)

Geschäftsführer / Managing Director / Gérant

ppa. (Jens Kaibel)

Technischer Leiter / Technical Director /
Directeur technique

VACUUBRAND GMBH + CO KG

Alfred-Zippe-Str. 4
97877 Wertheim

Tel.: +49 9342 808-0

Fax: +49 9342 808-5555

E-Mail: info@vacuubrand.com

Web: www.vacuubrand.com

VACUUBRAND®

8.7 UKCA conformity declaration

Declaration of Conformity



Manufacturer:

VACUUBRAND GMBH + CO KG · Alfred-Zippe-Str. 4 · 97877 Wertheim · Germany

Hereby the manufacturer declares that the device is in conformity with the directives:

- Supply of Machinery (Safety) Regulations 2008
(S.I. 2008 No. 1597, as amended by S.I. 2019 No. 696)
- Electromagnetic Compatibility Regulations 2016 (only VACUU-SELECT)
(S.I. 2016 No. 1091, as amended by S.I. 2019 No. 696)
- The Equipment and Protective Systems Intended for Use in Potentially Explosive Atmospheres Regulations 2016 (S.I. 2016 No. 1107, as amended by S.I. 2019 No. 696)
- The Restriction of the Use of Certain Hazardous Substances in Electrical and Electronic Equipment Regulations 2012 (S.I. 2012 No. 3032)

Chemistry pumping unit:

Type: **PC 510 select, PC 511 select, PC 520 select, PC 610 select, PC 611 select, PC 620 select**

Order number: **20733150, 20733151, 20733152, 20733156, 20733157 / 20733250, 20733251, 20733252, 20733256, 20733257 / 20733350, 20733351, 20733352, 20733356, 20733357 / 20737150, 20737151, 20737152, 20737156, 20737157 / 20737250, 20737251, 20737252, 20737256, 20737257 / 20737350, 20737351, 20737352, 20737356, 20737357**

Serial number: See rating plate

Designated standards applied:

EN ISO 12100:2010, EN 1012-2:1996+A1:2009, EN 61010-1:2010+A1:2019, EN 61010-1:2010/A1:2019/AC:2019-04
EN 61326-1:2013 (only VACUU-SELECT)
EN 1127-1:2019, EN ISO 80079-36:2016
EN IEC 63000:2018

Person authorised to compile the technical file:

Dr. Constantin Schöler · VACUUBRAND GMBH + CO KG · Germany

Place, date: Wertheim, 07.12.2022

(Dr. Constantin Schöler)
Managing Director

ppa.
(Jens Kaibel)

Technical Director

VACUUBRAND GMBH + CO KG

Alfred-Zippe-Str. 4
97877 Wertheim

Tel.: +49 9342 808-0

Fax: +49 9342 808-5555

E-Mail: info@vacuubrand.com

Web: www.vacuubrand.com

VACUUBRAND®

Keyword Index

A

Abbreviations used	11
Action instructions (image description)	10
Additional symbols	9
Ambient conditions	34
Assembling device and housing parts	74
ATEX device category	23, 25
ATEX device category and peripheral devices	23, 25

C

Changing a device fuse	76
Checking a device fuse	76
Cleaning, general	61
Connecting the exhaust hose	37
Connecting the outlet	37
Controls for vacuum controller	47
Coolant connection	38
Copyright	6

D

Dismantling housing parts	67
Disposal	24

E

Emission condenser	29
Error – cause – corrective measure .	57
Example of use: 2 applications in parallel	31
Example of use: drying	31
Example of use: local area vacuum network	30
Explanation of safety symbols	9
Explanation of usage/operating conditions X	24, 25
Exploded-view drawing of pump heads	64

F

Fine vacuum	12
from process A to process B	49
from process B to process A	50

I

Improper use	15
--------------------	----

Installing the vacuum pump	34
Instruction modules	7

L

Labels and signs	22
Looking out for dangers during ventilation	21

M

Maintenance interval	59
Measuring chamber	81
Membrane replacement	68
Misuse	15
Modular instruction manuals	7

O

Observe stability	20
Operator interface	46
Operator responsibilities	16
Operator safety measures	18
Overheating protection, blockage protection	22
Overview of chemistry pumping unit models	28

P

PC 510 select	28
PC 511 select	28
PC 520 select	28
PC 610 select	28
PC 611 select	28
PC 620 select	28
Personnel responsibilities	16
Possible residual energies	21
Preparing for maintenance	65
Presentation conventions	8
Presentation of action instructions .	10
Pressure display	46, 48
Preventing backlog in the exhaust line	20
Preventing overheating	21
Preventing sources of ignition ..	23, 25
Process display	46
Process screen	48
Product designation	78
Product-specific abbreviations	29
Product-specific terms	12

Proper use.....	14
Pump head maintenance.....	63

Q

Qualification description	17
Quality standards and safety.....	18

R

Recommended auxiliary equipment for cleaning and maintenance	59
Replacing membranes	68
Restart procedure	23
Rough vacuum.....	12

S

Safety instructions	14
Separator flask	29
Separator flask connections.....	29
Surface temperatures	21
Switching on	45
Switching on the pumping unit	45

T

Target groups	17
Technical data	78

V

Vacuum connection at inlet.....	35
Valve replacement.....	71
Vent inert gas.....	40
Vent with ambient air.....	39

W

Warning messages	8
Wetted materials	81
Who-does-what matrix	17

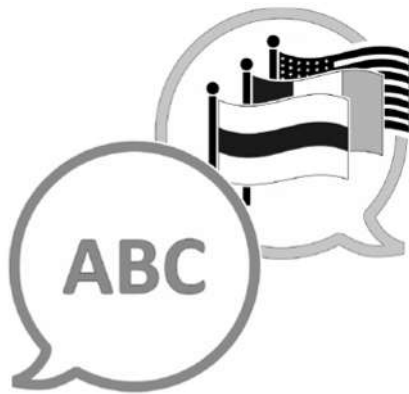

[VACUUBRAND > Support > Manuals](#)

Manufacturer:

VACUUBRAND GMBH + CO KG

Alfred-Zippe-Str. 4

97877 Wertheim

GERMANY

Head office: +49 9342 808-0

Sales: +49 9342 808-5550

Service: +49 9342 808-5660

Fax: +49 9342 808-5555

E-mail: info@vacuubrand.com

Web: www.vacuubrand.com