

■ MEGOHMMETER

6501
6503



ENGLISH

User Manual

 **AEMC**[®]
INSTRUMENTS
CHAUVIN ARNOUX GROUP

Statement of Compliance

Chauvin Arnoux®, Inc. d.b.a. AEMC® Instruments certifies that this instrument has been calibrated using standards and instruments traceable to international standards.

We guarantee that at the time of shipping your instrument has met its published specifications.

An NIST traceable certificate may be requested at the time of purchase, or obtained by returning the instrument to our repair and calibration facility, for a nominal charge.

The recommended calibration interval for this instrument is 12 months and begins on the date of receipt by the customer. For recalibration, please use our calibration services. Refer to our repair and calibration section at www.aemc.com.

Serial #: _____

Catalog #: 2126.51/2126.52

Model #: 6501/6503

Please fill in the appropriate date as indicated:

Date Received: _____

Date Calibration Due: _____



Chauvin Arnoux®, Inc.
d.b.a AEMC® Instruments
www.aemc.com

Table of Contents

1. INTRODUCTION	3
1.1 International Electrical Symbols.....	4
1.2 Definition of Measurement Categories.....	4
1.3 Receiving Your Shipment.....	5
1.4 Ordering Information	5
1.4.1 Accessories and Replacement Parts	5
2. PRODUCT FEATURES	6
2.1 Description	6
2.2 Features.....	6
2.3 Model 6501 Control Features	8
2.4 Model 6503 Control Features	9
3. SPECIFICATIONS	10
4. OPERATION.....	12
4.1 Auto-ranging	12
4.2 Safety Check - Voltage Test.....	12
4.3 Insulation Resistance Testing (M Ω Range).....	12
4.3.1 Test Voltage.....	13
4.3.2 Spot Testing.....	13
4.3.3 Ratio Testing.....	14
4.4 Successful Insulation Resistance Testing	14
4.5 Utilization of the Guard Terminal (Model 6503)	15
4.6 Insulation Measurement - Connections	17
4.7 Insulation Resistance on Motors.....	21

5. MAINTENANCE	24
5.1 Warning	24
5.2 Cleaning	24
5.3 Fuse Replacement.....	25
Repair and Calibration.....	26
Technical and Sales Assistance	26
Limited Warranty	27
Warranty Repairs.....	27





INTRODUCTION



These safety warnings are provided to ensure the safety of personnel and proper operation of the instrument.

- Read the instruction manual completely and follow all safety information before operating this instrument.
- Safety is the responsibility of the operator!
- Tests are to be carried out only on dead circuits! Check for live circuits before making resistance measurements (safety check).
- These megohmmeters are rated for 600V CAT II or 300V CAT III - Pollution Degree 2.
- The Megohmmeter Models 6501/6503 are sources of high voltage, as is the sample connected to them. All persons performing or assisting in the tests must employ all safety precautions to prevent electrical shock to themselves and to others.
- AEMC® Instruments considers the use of rubber gloves to be an excellent safety practice even if the equipment is properly operated and correctly grounded.
- When testing capacitance samples, make sure that they have been properly discharged and that they are safe to touch. Dielectric insulation samples should be short-circuited for at least five times the amount of time they were energized.
- Use the leads supplied with the megohmmeter. If defective or used, replace before testing.

1.1 International Electrical Symbols

	This symbol signifies that the instrument is protected by double or reinforced insulation.
	This symbol on the instrument indicates a WARNING and that the operator must refer to the user manual for instructions before operating the instrument. In this manual, the symbol preceding instructions indicates that if the instructions are not followed, bodily injury, installation/sample and product damage may result.
	Risk of electric shock. The voltage at the parts marked with this symbol may be dangerous.
	In conformity with WEEE 2002/96/EC

1.2 Definition of Measurement Categories

- CAT IV:** For measurements performed at the primary electrical supply (<1000V) such as on primary overcurrent protection devices, ripple control units, or meters.
- CAT III:** For measurements performed in the building installation at the distribution level such as on hardwired equipment in fixed installation and circuit breakers.
- CAT II:** For measurements performed on circuits directly connected to the electrical distribution system. Examples are measurements on household appliances or portable tools.

1.3 Receiving Your Shipment

Upon receiving your shipment, make sure that the contents are consistent with the packing list. Notify your distributor of any missing items. If the equipment appears to be damaged, file a claim immediately with the carrier and notify your distributor at once, giving a detailed description of any damage. Save the damaged packing container to substantiate your claim. Do not use an instrument that appears to be damaged.

1.4 Ordering Information

Megohmmeter Model 6501 **Cat. #2126.51**
Includes a soft carrying case, two color-coded leads, two insulated alligator clips, test probe and user manual.

Megohmmeter Model 6503 **Cat. #2126.52**
Includes a soft carrying case, three color-coded leads, three insulated alligator clips, test probe and user manual.

1.4.1 Accessories and Replacement Parts

Replacement soft carrying case.....	Cat. #2126.71
Safety alligator clip - red	Cat. #2140.52
Safety alligator clip - black	Cat. #2140.53
Safety alligator clip - blue	Cat. #2140.54
Replacement Fuse - 0.2A, 600V HPC	Cat. #2970.95
Black test probe	Cat. #5000.30
Red test probe.....	Cat. #5000.31
Lead - set of 2, color-coded (red/black)	Cat. #5000.78
Lead - set of 3, color-coded (red/black/blue)	Cat. #5000.93

PRODUCT FEATURES

2.1 Description

The AEMC® Models 6501 and 6503 are compact, self-contained hand-cranked megohmmeters. They are practical and dependable instruments designed for a broad range of plant and field service applications, such as acceptance testing and preventive maintenance of wiring, cables, switchgear, and motors. The easy hand-cranked operation provides a steady rectified DC voltage output across the entire range for consistently reliable readings.

These megohmmeters incorporate a built-in generator and a constant DC voltage circuit to provide a stable output and give direct insulation resistance reading.

The Models 6501/6503 have a unique auto-ranging feature which expands the scale by x10 and almost doubles the scale length. When the pointer reaches near the end of scale, the auto-ranging feature activates, returning the pointer to the beginning of the scale with the x10 red LED indicator on.

Insulation resistance is indicated with a rugged taut-band meter movement on a logarithmic scale. The indicator scale is easy to read.

2.2 Features

- Measures insulation at 500V, resistance and continuity (Model 6501)
- Three test voltages: 250V, 500V, 1000V (Model 6503)

- Test voltage constant across the entire measurement range
- Autoranging M Ω , k Ω and Ω ranges (Model 6501)
- Autoranging M Ω ranges (Model 6503)
- Designed for harsh environments: offshore, mining, heavy-duty field, industrial, and military use
- Compact, self-contained package; folding crank
- Large direct reading scale
- 600V test voltage range (safety check)

2.3 Model 6501 Control Features

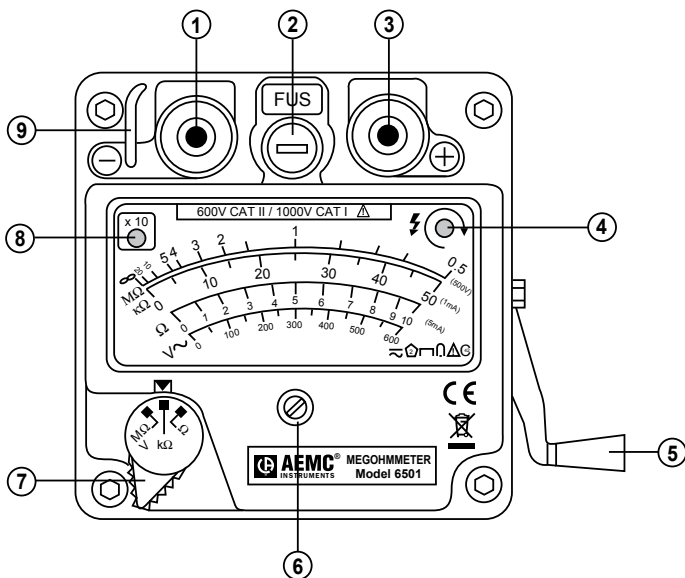

Figure 2-1

1. Line (-) terminal Black
2. Fuse 0.2A
3. Earth (+) terminal Red
4. Amber LED illuminates when proper crank speed is attained, indicating presence of selected output
5. Foldaway handle
6. Mechanical zero adjustment screw
7. Range switch - safety test first on MΩ/V range to 600VAC
8. Autoranging: Red LED illuminates when reading needs to be multiplied x10 to obtain the true value (MΩ, kΩ, Ω ranges)
9. Security finger rest isolates users hand from terminals while giving a firm grip during an operation

2.4 Model 6503 Control Features

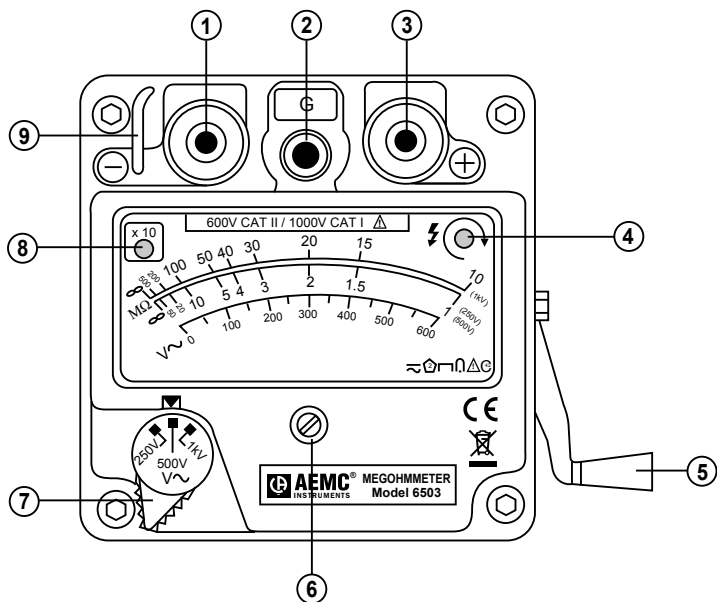

Figure 2-2

1. Line (-) terminal - Black
2. Guard terminal - Blue
3. Earth (+) terminal - Red
4. Green LED illuminates when proper crank speed is attained, indicating presence of selected test voltage
5. Foldaway handle
6. Mechanical zero adjustment screw
7. Range switch - Safety test first on 600V/V~ range to 600VAC
8. Autoranging: Red LED illuminates when reading needs to be multiplied x10 to obtain the true value (MΩ range)
9. Security finger rest isolates users hand from terminals while giving a firm grip during an operation

SPECIFICATIONS

MODELS	6501	6503
ELECTRICAL		
Insulation Tests		
Test Voltage 250V 500V 1000V	– 0.5 to 5.5M Ω ; 5.5 to 200M Ω –	1 to 11M Ω ; 11 to 500M Ω 1 to 11M Ω ; 11 to 500M Ω 10 to 110M Ω ; 110 to 500M Ω
Short Circuit Current	5mA (max)	
Accuracy	2.5% of Scale Length	
Resistance Tests		
Measurement Range (Auto-Ranging)	0 to 45k Ω ; 45 to 500k Ω	–
DC Test Current	1 mA constant, 500V max	–
Accuracy	2.5% of Scale Length	–
Automatic Discharge	5s/ μ F	8s/ μ F
Continuity Tests		
Test Voltage	5mA constant, 10V max	–
Measurement Range (Auto-Ranging)	0 to 9 Ω ; 10 to 100 Ω	–
Accuracy	2.5% of Scale Length	–
Fuse Protection	0.2A, 600V HPC 6x32mm	–
Voltage Tests/Safety Check		
Voltage Range	0 to 600Vac	
Frequency	45 to 450Hz	
Accuracy	3% of Scale	
Input Impedance	100k Ω (approx)	

MODELS	6501	6503
Scale	Direct reading on all ranges; 3" (76mm), black on white	
Test Voltage Indicator	Amber LED indicates proper test voltage and crank speed NOTE: If the LED is not ON during testing, the reading is not valid	Green LED indicates proper test voltage and crank speed NOTE: If the LED is not ON during testing, the reading is not valid
Auto-Range Indicator	Red LED indicates Auto-Range; multiply M Ω , k Ω & Ω readings x 10	Red LED indicates Auto-Range; multiply M Ω readings x 10
Power Source	Hand-cranked, heavy duty brushless alternator and solid state rectification and amplification for stable voltage; test voltage reached at 140rpm (approx)	
Meter Movement	Rugged taut band suspension	
MECHANICAL		
Dimensions	4.7 x 4.4 x 5.3" (120 x 111 x 135mm) with lid	
Weight	2.5 lbs (1.1kg)	
Terminals	" + " Line (red); " - " earth (black); accepts standard 4mm safety plugs	
ENVIRONMENTAL		
Temperature Reference Operating Range Storage Range	68 to 79°F (20 to 26°C), 30 to 50% RH 14 to 113°F (-10 to 45°C), 0 to 75% RH -4 to 176°F (-20 to 80°C), 0 to 90% RH	
SAFETY		
Sealed	IP54 with lid, IP52 without lid	
Rating	EN 61010-1, 600V CAT II; 300V CAT III; Pollution Degree 2	
Double Insulation	Yes	
CE Mark	Yes	

**Specifications are subject to change without notice*

OPERATION

4.1 Auto-ranging

How it works: When the pointer reaches approximately 90% of the full scale length, the auto-range is triggered, the red auto-range (x10) LED lights up. The pointer goes back to the beginning of the scale and resumes its travel. The readings should be multiplied by 10 when the x10 LED is on.

4.2 Safety Check - Voltage Test

Before measuring insulation resistance, confirm that the sample is fully discharged (particularly in dielectric and capacitance samples) and that the sample is not connected to an energized circuit.

To perform the voltage test, set the range selection to V M Ω (Model 6501) or 500V M Ω (Model 6503), connect and read on the red voltage scale (600VAC max). **DO NOT CRANK.** If measuring on a DC circuit, the pointer will deflect but the measurement may be inaccurate.

4.3 Insulation Resistance Testing (M Ω Range)

After checking for a live circuit (see safety check), select the test voltage and connect the megohmmeter. Several connection examples are illustrated further. Crank the handle until the Amber LED (Model 6501) or Green LED (Model 6503) on the upper right-hand side lights, ensuring that the selected test voltage has been reached.

4.3.1 Test Voltage

No published standard tells which voltage to choose for any given winding. However, published recommendations could be summarized as follows:

Rated Voltage of Motor	Test Voltage
Below 115	250V
115	250 or 500V
230	500V
460	500 or 1000V

4.3.2 Spot Testing

As a general rule in spot testing, test voltage should be applied until no variation in reading is noted for 15 seconds or applied for a fixed 60 seconds. On capacitance circuits, cranking for up to a minute or more may be necessary to fully charge the sample. What minimum value should be measured? The IEEE standard N° 43-2000 states that it is impossible to specify the value of insulation resistance at which a winding will fail electrically, but on motors, minimum readings generally stated are:

<u>Rated Voltage</u>	<u>R minimum</u>
250 or less	2 M Ω
460	2 M Ω

There is no fixed figure for determining what is good and bad in resistance readings, but a good guide would be 1M Ω for every one hundred applied operating volts, as a minimum figure. This applies to motors and transformers. When the insulation resistance gets this low, an electrical break-down can be expected at any time and rewinding or replacing should be considered.

It is not unusual for a winding to be 10 to 100 times the recommended minimum value (IEEE standard 43-2000: *Recommended Practice for Testing Insulation Resistance of Rotating Machinery*), but this varies with temperature and humidity.

4.3.3 Ratio Testing

In time resistance reading (Dielectric Absorption Ratio), readings are taken at 30 seconds and 60 seconds to obtain the dielectric absorption ratio.

$$\frac{\text{Insulation resistance @ 60s}}{\text{Insulation resistance @ 30s}} = \text{Dielectric Absorption ratio (DAR)}$$

This test is useful to increase the accuracy of spot testing. In general, a ratio of 1.25:2 or better should be required. A ratio below this indicates that repair is probably needed.

Remember that a DC insulation test may be used for acceptance testing, but is more commonly used to check the gradual deterioration of equipment over its life. Consult your equipment manufacturer for specific test or test voltage if not known.

Insulation resistance decreases with moisture, temperature and age and should be recorded over time at a given temperature and corrected.

4.4 Successful Insulation Resistance Testing

- Check with the equipment manufacturer for factory insulation resistance readings.
- Do not rely on insulation resistance testing alone as proof of winding conditions.
- Do not expect the same value for all parts of all machines.
- Observe consistent test time duration, recognizing that total current through insulation under test will vary with time.
- Correct all readings properly to a standard reference temperature (see IEEE std #43-2000, *Temperature Correction Curve*).
- Know what you are testing. Isolate the piece of equipment from other circuitry.
- Watch trends rather than relying on single “spot” readings.

4.5 Utilization of the Guard Terminal (Model 6503)

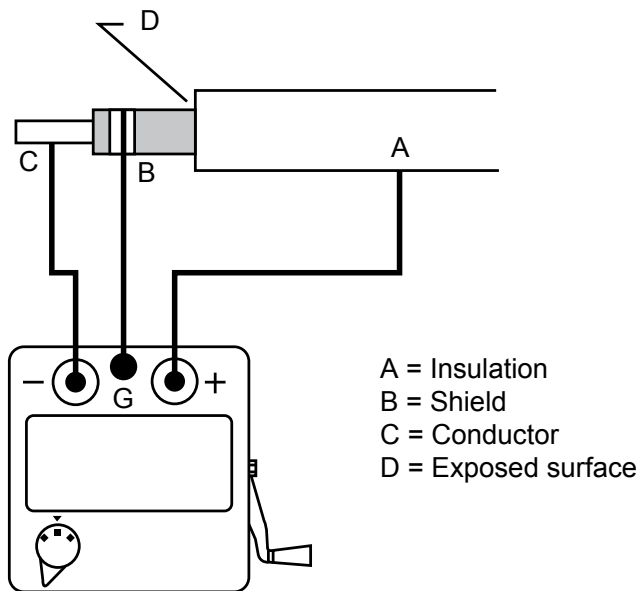

Figure 4-1

Guard terminals are useful when measuring high resistance values and for stabilizing readings.

When testing the insulation at the end of a cable, it is necessary to eliminate the error from surface leakage which occurs, particularly at high resistance values. The purpose of the guard terminal is to provide a third terminal within the path of the surface leakage "D". Connect the instrument as shown in Figure 4-1.

If there is no shield at "B", use a copper wire wound several times around the exposed surface "B". (Note: If a shield is not available and you do not make up a shield around "B" and connect to the guard terminal (-), the measurement will be erroneous and lead to confusion as to the cable's state.)

If the guard terminal is not connected at “B”, the instrument measures the current “I” flowing through the insulation and a surface leakage current “i1”. See Figure 4-2.

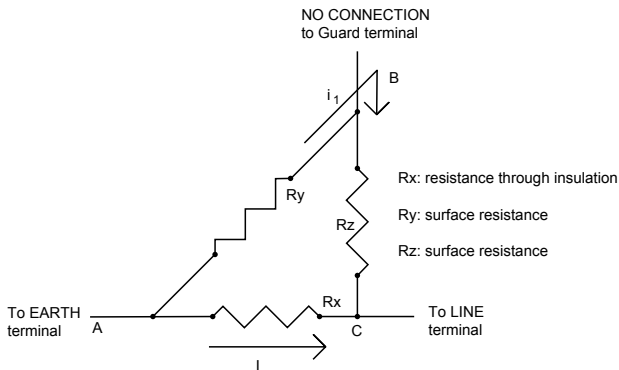

Figure 4-2

When the guard terminal is connected at “B”, the instrument measures the current “I” and not the surface leakage current “i1”, which is not included in the measurement. See Figure 4-3. This type of measurement will give the true value of the resistance “Rx”, providing the “Ry” and “Rz” are not too low.

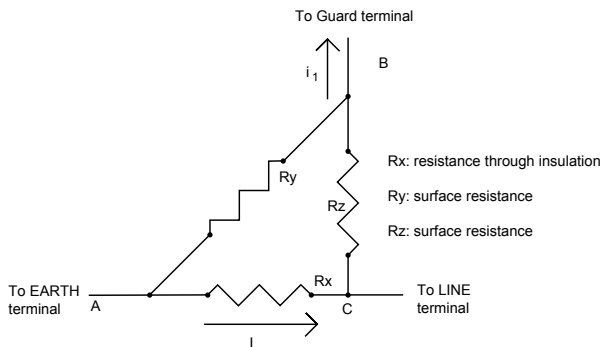

Figure 4-3

4.6 Insulation Measurement - Connections

Figure 4-4 shows the connections to measure the insulation of one conductor to the other conductors. The cable should be disconnected at both ends to avoid leakage through switchboards and panels. For the Model 6503, the connection to the guard terminal is used to eliminate the effects of surface leakage across exposed insulation at one end of the cable. Refer to the section on Utilization of the Guard Terminal (§ 4.5).

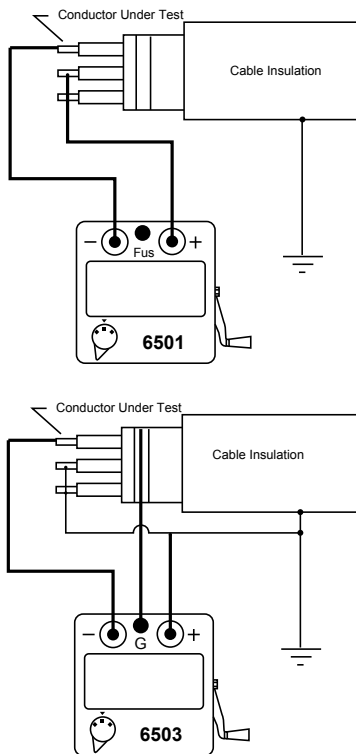

Figure 4-4

Figure 4-5 shows the connections for testing insulation from a supply conductor to ground (motor frame).

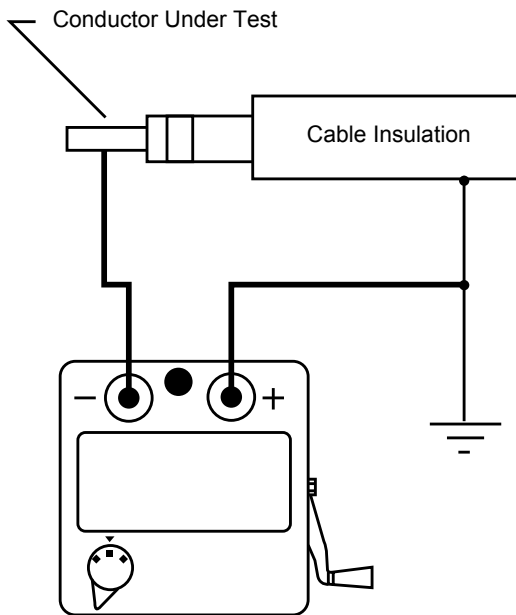

Figure 4-5

Figure 4-6 shows the connections to a transformer (lighting or distribution). Make sure that the switches and/or circuit breakers on both sides are open. Check the high voltage winding to ground, low voltage to ground, and the resistance between them with no winding ground.

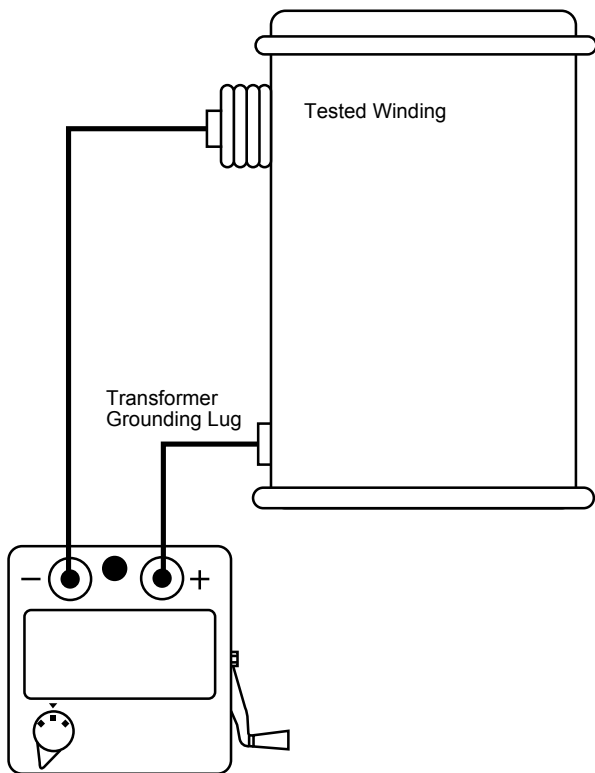

Figure 4-6

Figure 4-7 shows the connections for measuring the insulation of a three-phase line to ground by connecting the jumpers between phases. This gives a reading of all conductors at once. If a load such as a motor, heater, etc., is attached to the other end of the line, it will read the load resistance to ground at the same time. By removing the jumpers, readings can be made between the individual conductors and ground.

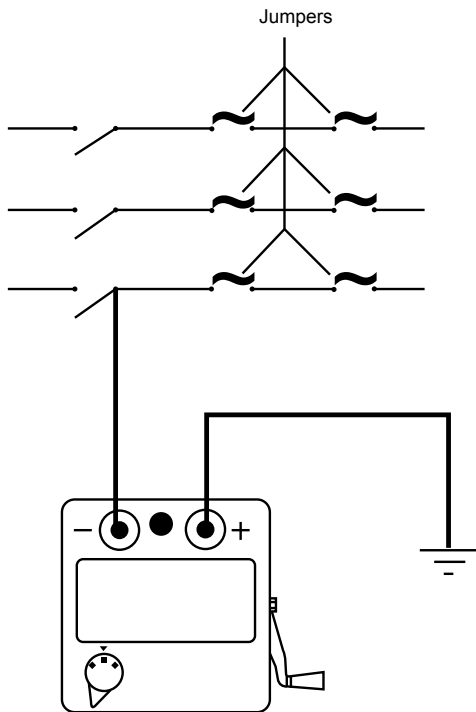

Figure 4-7

4.7 Insulation Resistance on Motors

Figure 4-8 shows reading the resistance to ground of a three-phase motor winding. Since the three-phase motors are internally connected, it is only necessary to connect one lead to the motor lead and the other lead to the motor frame as shown.

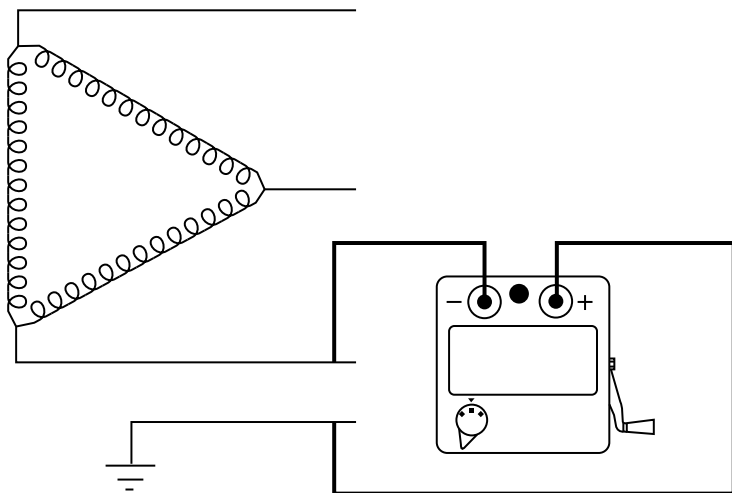

Figure 4-8

Figure 4-9 shows the windings of a three-phase motor separated. Sometimes this can be done at the lead terminals while other times the end bells must be removed to get at the lead wires of the coils. By connecting the megohmmeter as shown, the phase insulation resistance value can now be determined. Read between phases "A" and "B", then "B" and "C", then "C" and "A".

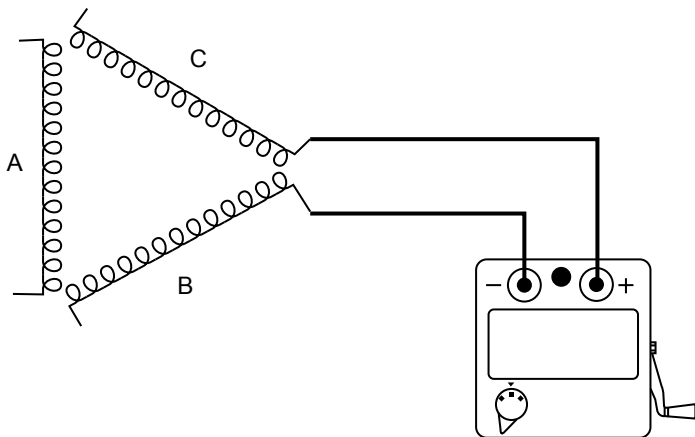

Figure 4-9

Figure 4-10 shows connections for testing insulation from a supply conductor in a switchbox to ground (motor frame). An identical test may be carried out from the motor starter.

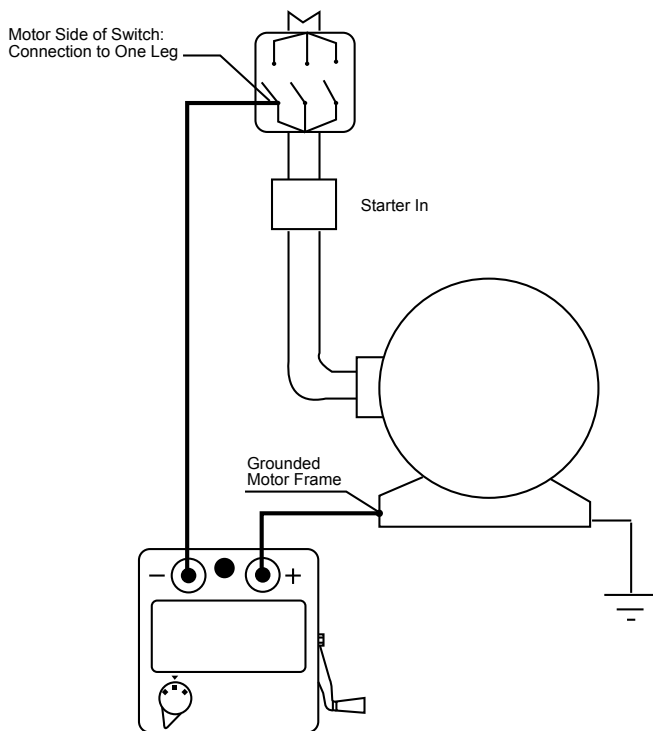

Figure 4-10

MAINTENANCE

5.1 Warning

- For maintenance use only original factory replacement parts.
- To avoid electrical shock, do not attempt to perform any servicing unless you are qualified to do so.
- Do not perform any service while the Megohmmeter Model 6501/6503 is on any circuit.
- To avoid electrical shock and/or damage to the instrument, do not let water or other foreign agents into the electronic module.



Warning: If the crank speed LED is not ON during testing, the reading is not valid.

5.2 Cleaning

The megohmmeter may be gently cleaned with a soft cloth, soap and water. Dry immediately after cleaning. Avoid water penetration into the electronic module.

Make sure the megohmmeter and all leads are dry before further use.

5.3 Fuse Replacement



WARNING: For your safety, fold the crank and disconnect all of the leads from the meter.

- With a flat screwdriver or a coin, push and turn the fuse holder a quarter turn counter-clockwise.
- Replace the fuse with an identical one - 0.2A, 600V HPC 6x32mm

Repair and Calibration

To ensure that your instrument meets factory specifications, we recommend that it be scheduled back to our factory Service Center at one-year intervals for recalibration, or as required by other standards or internal procedures.

For instrument repair and calibration:

You must contact our Service Center for a Customer Service Authorization Number (CSA#). This will ensure that when your instrument arrives, it will be tracked and processed promptly. Please write the CSA# on the outside of the shipping container. If the instrument is returned for calibration, we need to know if you want a standard calibration, or a calibration traceable to N.I.S.T. (Includes calibration certificate plus recorded calibration data).

Ship To: Chauvin Arnoux®, Inc. d.b.a. AEMC® Instruments
15 Faraday Drive
Dover, NH 03820 USA
Phone: (800) 945-2362 (Ext. 360)
(603) 749-6434 (Ext. 360)
Fax: (603) 742-2346 or (603) 749-6309
E-mail: repair@aemc.com

(Or contact your authorized distributor)

Costs for repair, standard calibration, and calibration traceable to N.I.S.T. are available.

NOTE: You must obtain a CSA# before returning any instrument.

Technical and Sales Assistance

If you are experiencing any technical problems, or require any assistance with the proper operation or application of your instrument, please call, mail, fax or e-mail our technical support team:

Chauvin Arnoux®, Inc. d.b.a. AEMC® Instruments
200 Foxborough Boulevard
Foxborough, MA 02035 USA
Phone: (800) 343-1391
(508) 698-2115
Fax: (508) 698-2118
E-mail: techsupport@aemc.com
www.aemc.com

NOTE: Do not ship Instruments to our Foxborough, MA address.

Limited Warranty

The Models 6501 and 6503 are warranted to the owner for a period of two years from the date of original purchase against defects in manufacture. This limited warranty is given by AEMC® Instruments, not by the distributor from whom it was purchased. This warranty is void if the unit has been tampered with, abused or if the defect is related to service not performed by AEMC® Instruments.

For full and detailed warranty coverage, please read the Warranty Coverage Information, which is attached to the Warranty Registration Card (if enclosed) or is available at www.aemc.com. Please keep the Warranty Coverage Information with your records.

What AEMC® Instruments will do:

If a malfunction occurs within the warranty period, you may return the instrument to us for repair, provided we have your warranty registration information on file or a proof of purchase. AEMC® Instruments will, at its option, repair or replace the faulty material.

REGISTER ONLINE AT: www.aemc.com

Warranty Repairs

What you must do to return an Instrument for Warranty Repair:

First, request a Customer Service Authorization Number (CSA#) by phone or by fax from our Service Department (see address below), then return the instrument along with the signed CSA Form. Please write the CSA# on the outside of the shipping container. Return the instrument, postage or shipment pre-paid to:

Ship To: Chauvin Arnoux®, Inc. d.b.a. AEMC® Instruments
15 Faraday Drive • Dover, NH 03820 USA
Phone: (800) 945-2362 (Ext. 360)
(603) 749-6434 (Ext. 360)
Fax: (603) 742-2346 or (603) 749-6309
E-mail: repair@aemc.com

Caution: To protect yourself against in-transit loss, we recommend you insure your returned material.

NOTE: You must obtain a CSA# before returning any instrument.



10/19

99-MAN 100328 v9

Chauvin Arnoux®, Inc. d.b.a. **AEMC®** Instruments
15 Faraday Drive • Dover, NH 03820 USA
Phone: (603) 749-6434 • Fax: (603) 742-2346
www.aemc.com