

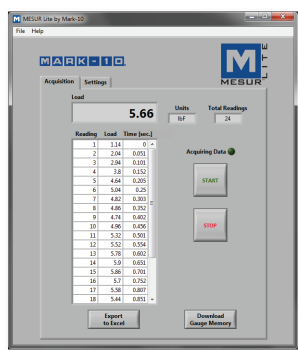

The 3i digital force / torque indicator is designed to work with a wide range of Mark-10 remote force and torque sensors (see page 3). With exclusive Plug & Test™ technology, all calibration and configuration data is saved within the sensor's smart connector, not the indicator, allowing for true interchangeability. In addition, all sensors are fully compatible with other Mark-10 indicators.

The 3i shares its menu structure and most specifications with Series 3 digital force gauges. The sampling rate is 2,000 Hz, producing accurate results under a wide range of test conditions. A backlit graphic LCD displays large characters, and a menu is available to access the gauges' features and configurable parameters. The display also features an analog load bar for graphical representation of applied load, as well as set point indicators for pass-fail testing. USB output is provided for data collection purposes.

The gauges include MESUR™ Lite data acquisition software. MESUR™ Lite tabulates continuous or single point data. One-click export to Excel allows for further data manipulation.



MESUR™ Lite data acquisition software is included with the 3i



3i is shown mounted to an optional AC1008 tabletop stand with Series R03 force sensor

Features

- Interchangeable force and torque sensors through Plug & Test™ technology
- High-speed 2,000 Hz sampling rate
- USB data output of continuous or individual data points
- Ultra-compact size
- Large backlit graphic display
- Programmable set points with pass/fail indicators
- Live load bar graph with set point markers
- Peak readings and set points always displayed
- Configurable audio alarms and key tones
- 4 selectable units of measurement
- MESUR™ Lite data collection software included

Display Indicators



Focus on Engineering: Plug & Test™ Technology

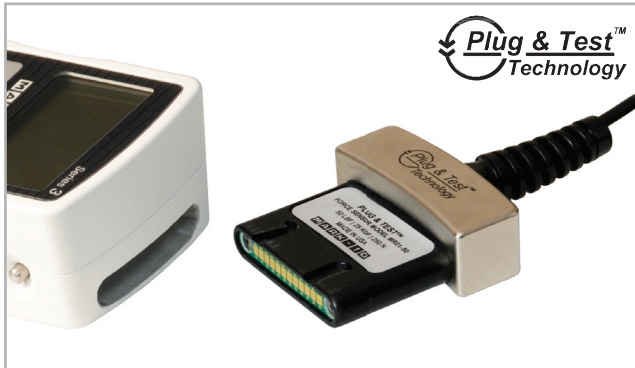

^ Unique Plug & Test™ technology allows for interchangeable sensors to be used with a Mark-10 model 7i, 5i, or 3i indicator. All calibration and configuration data is saved in the smart connector.

^ The Plug & Test™ connector locks into the receptacle in the indicator when fully inserted. Dual buttons on the indicator housing release the connector for easy removal. Gold plated spring contacts ensure long lasting and reliable connection.

Specifications

Accuracy:	±0.2% of full scale + sensor
Sampling Rate:	2,000 Hz
Power:	AC or rechargeable battery. Multi-step low battery indicator is displayed, gauge shuts off automatically when power is too low.
Battery life:	Backlight on: up to 7 hours of continuous use Backlight off: up to 24 hours of continuous use
USB Output:	Configurable to 115,200 baud.
Weight:	0.7 lb [0.3 kg]
Included items:	Carrying case, universal voltage AC adapter, battery, quick-start guide, USB cable, resource CD (USB driver, MESUR™ Lite software, MESUR™gauge DEMO software, and user's guide), and certificate of conformance.
Environmental requirements:	40 - 100°F, max. 96% humidity, non-condensating
Warranty:	3 years (see individual statement for further details)

Dimensions in [mm]

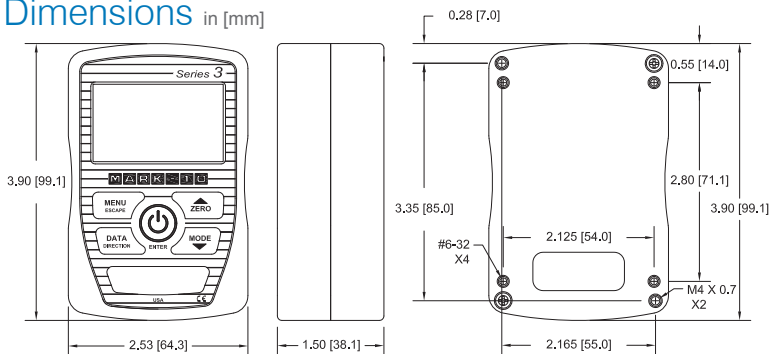

Ordering Information

Model	Description
M3I	Advanced Force / Torque Indicator, 110V
M3IE	Advanced Force / Torque Indicator, 220V, European Plug
M3IU	Advanced Force / Torque Indicator, 220V, UK Plug
M3IA	Advanced Force / Torque Indicator, 220V, Australian Plug
AC1008	Tabletop mounting kit

Models 7i, 5i, and 3i force / torque indicators are designed for use with Mark-10's Plug & Test™ remote force and torque sensors. All calibration and configuration data is saved within the sensors' smart connectors - not the indicator - allowing for true interchangeability. Each sensor series is available in a range of capacities, from 0.25 to 10,000 lbf (1 N to 50 kN) full scale and from 10 ozFin to 5,000 lbFin (7 Ncm to 550 Nm) full scale. Refer to individual sensor data sheets for further details.

Series R50

Universal torque sensors, fixed chuck

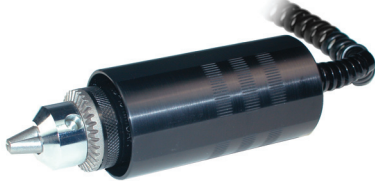

Series R51

Universal torque sensors, interchangeable attachments

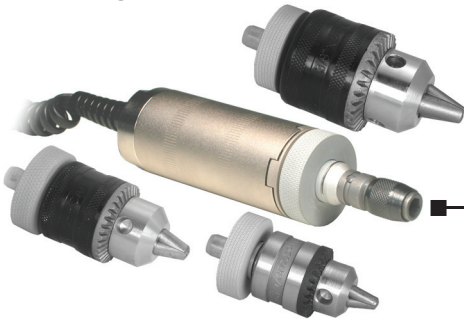

Series R55

Torque sensors



Series R52

Static torque sensors

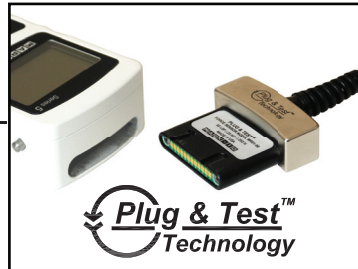
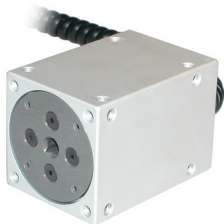

Series R01

Tension / compression sensors

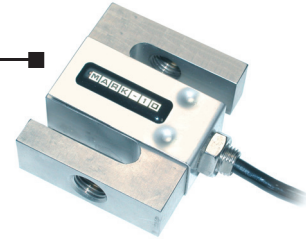

Series R03

Inline tension / compression sensors



Series R04

Miniature tension / compression sensors



Series R02

Compact compression sensors

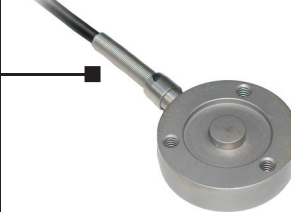

Series R05

Ergonomics testing push / pull sensors



Model 7i

Professional Indicator



Model 5i

Advanced Indicator



Model 3i

Basic Indicator



Series R53

Closure torque sensors

