

Keysight 34941A-34942A RF Multiplexer Modules

Notices

Copyright Notice

© Keysight Technologies 2008-2022

No part of this manual may be reproduced in any form or by any means (including electronic storage and retrieval or translation into a foreign language) without prior agreement and written consent from Keysight Technologies as governed by United States and international copyright laws.

Trademarks

Microsoft® and Windows® are U.S. registered trademarks of Microsoft Corporation.

Manual Part Number

34980-90041

Edition

Edition 4, Aug 2022

Printed in:

Printed in Malaysia

Published by:

Keysight Technologies
Bayan Lepas Free Industrial Zone,
11900 Penang, Malaysia

Technology Licenses

The hardware and/or software described in this document are furnished under a license and may be used or copied only in accordance with the terms of such license.

Declaration of Conformity

Declarations of Conformity for this product and for other Keysight products may be downloaded from the Web. Go to <http://www.keysight.com/go/conformity>. You can then search by product number to find the latest Declaration of Conformity.

U.S. Government Rights

The Software is “commercial computer software,” as defined by Federal Acquisition Regulation (“FAR”) 2.101. Pursuant to FAR 12.212 and 27.405-3 and Department of Defense FAR Supplement (“DFARS”) 227.7202, the U.S. government acquires commercial computer software under the same terms by which the software is customarily provided to the public. Accordingly, Keysight provides the Software to U.S. government customers under its standard commercial license, which is embodied in its End User License Agreement (EULA), a copy of which can be found at <http://www.keysight.com/find/sweula>. The license set forth in the EULA represents the exclusive authority by which the U.S. government may use, modify, distribute, or disclose the Software. The EULA and the license set forth therein, does not require or permit, among other things, that Keysight: (1) Furnish technical information related to commercial computer software or commercial computer software documentation that is not customarily provided to the public; or (2) Relinquish to, or otherwise provide, the government rights in excess of these rights customarily provided to the public to use, modify, reproduce, release, perform, display, or disclose commercial computer software or commercial computer software documentation. No additional government requirements beyond those set forth in the EULA shall apply, except to the extent that those terms, rights, or licenses are explicitly required from all providers of commercial computer software pursuant to the FAR and the DFARS and are set forth specifically in writing elsewhere in the EULA. Keysight shall be under no obligation to update, revise or otherwise modify the Software. With respect to any technical data as defined by FAR 2.101, pursuant to FAR 12.211 and 27.404.2 and DFARS 227.7102, the U.S. government acquires no greater than Limited Rights as defined in FAR 27.401 or DFAR 227.7103-5 (c), as applicable in any technical data.

Warranty

THE MATERIAL CONTAINED IN THIS DOCUMENT IS PROVIDED “AS IS,” AND IS SUBJECT TO BEING CHANGED, WITHOUT NOTICE, IN FUTURE EDITIONS. FURTHER, TO THE MAXIMUM EXTENT PERMITTED BY APPLICABLE LAW, KEYSIGHT DISCLAIMS ALL WARRANTIES, EITHER EXPRESS OR IMPLIED, WITH REGARD TO THIS MANUAL AND ANY INFORMATION CONTAINED HEREIN, INCLUDING BUT NOT LIMITED TO THE IMPLIED WARRANTIES OF MERCHANTABILITY AND FITNESS FOR A PARTICULAR PURPOSE. KEYSIGHT SHALL NOT BE LIABLE FOR ERRORS OR FOR INCIDENTAL OR CONSEQUENTIAL DAMAGES IN CONNECTION WITH THE FURNISHING, USE, OR PERFORMANCE OF THIS DOCUMENT OR OF ANY INFORMATION CONTAINED HEREIN. SHOULD KEYSIGHT AND THE USER HAVE A SEPARATE WRITTEN AGREEMENT WITH WARRANTY TERMS COVERING THE MATERIAL IN THIS DOCUMENT THAT CONFLICT WITH THESE TERMS, THE WARRANTY TERMS IN THE SEPARATE AGREEMENT SHALL CONTROL.

Safety Information

CAUTION















A CAUTION notice denotes a hazard. It calls attention to an operating procedure, practice, or the like that, if not correctly performed or adhered to, could result in damage to the product or loss of important data. Do not proceed beyond a CAUTION notice until the indicated conditions are fully understood and met.

WARNING

A WARNING notice denotes a hazard. It calls attention to an operating procedure, practice, or the like that, if not correctly performed or adhered to, could result in personal injury or death. Do not proceed beyond a WARNING notice until the indicated conditions are fully understood and met.

Safety Symbols

The following symbols or markings that may be on or with the instrument and in the documentation indicate precautions which must be taken to maintain safe operation of the instrument.

	Alternating current (AC)		Frame or chassis (ground) terminal
	Standby supply. Unit is not completely disconnected from ac mains when switch is off		Caution, risk of electric shock
	Caution, risk of danger (refer to this manual for specific Warning or Caution information)		Direct current (DC)
	Off (mains supply)		On (mains supply)
	Three phase alternating current		Presence of a laser device
	Protective earth (ground) terminal		Equipment protected throughout by double insulation or reinforced insulation
	Caution, hot surface		Product is sensitive to electrostatic discharge

Additional Safety Notices

The following general safety precautions must be observed during all phases of operation of this instrument. Failure to comply with these precautions or with specific warnings or instructions elsewhere in this manual violates safety standards of design, manufacture, and intended use of the instrument. Keysight Technologies assumes no liability of the customer's failure to comply with the requirements.

WARNING

Refer to the 34980A User's Guide before using the equipment. The 34980A User's Guide contains additional important information about the modules.

WARNING

GENERAL

If this product is not used as specified in the operating instructions, the protection provided by the equipment could be impaired. This product must be used in a normal condition (in which all means for protection are intact) only. Any external connections must be made prior to applying power.

WARNING

DO NOT REMOVE THE INSTRUMENT COVER

No operator serviceable parts inside. Do not install substitute parts or perform any unauthorized modifications to the instrument. Return the instrument to Keysight for service and repair to ensure the safety features are maintained in operational condition. Instruments that appear damaged or defective should be made inoperative and secured against unintended operation until they can be repaired.

WARNING**GROUND THE INSTRUMENT**

This is a Safety Protection Class I Product (provided with a protective earthing ground incorporated in the power cord). The mains plug shall only be inserted in a socket outlet provided with a protective earth contact. Any interruption of the protective conductor inside or outside of the product is likely to make the product dangerous. Intentional interruption is prohibited. The mains wiring and connectors shall be compatible with the connector used in the premise electrical system. Inadequate earth grounding can damage the instrument. Always use the three-prong AC power cord supplied with the instrument.

Connect the AC power cord as follow:

- Ensure that the power cord is not damaged.
 - Install the signal generator so that one of the following items is readily identifiable and easily reached by the operator: AC power cord, alternative switch or circuit breaker.
 - Insert the mains plug into a socket outlet provided with a protective earth grounding.
-

WARNING**IN CASE OF DAMAGE**

Do not use the instrument if it is damaged. Before you use the instrument inspect all connections. Pay particular attention to the insulation surrounding connectors and / or cable assembly insulation. NEVER use a cable showing any signs of damage. Faulty cables can cause electrical shock and /or fire hazards and could lead to personal injury or death.

WARNING

Refer to the User Guides of the 34980A and relevant modules before using the equipment.

WARNING

The detachable power cord is the instrument disconnecting device. It disconnects the mains circuits from the mains supply before other parts of the instrument. The front panel switch is only a standby switch and is not a LINE switch (disconnecting device). The instrument power cord does not disconnect or de-energize external circuits connected to the analog bus, terminal blocks or modules.

WARNING

Safety of any system incorporating the equipment is the responsibility of the assembler of the system.

WARNING

Keysight Customers utilizing the Open Platform Test Systems are classified as follows and require the user to have the appropriate skillset:

Operator: Interacts with the test system in a production environment, selection of test sequences, defining variables, running tests (test results, test statistics, control of marking devices)

Supervisor: Includes access to maintenance functions and utility sequences (control of hardline system functions, access to test area)

Developer: Full access

WARNING

Dangerous voltage levels capable of causing death, may be present on a channel. Use extreme caution when handling and testing and adjusting this instrument. Any voltages greater than 30 Vrms, 42.4 Vpeak and 60 Vdc are considered hazardous (IEC 61010-1).

WARNING

Removal of the instrument's cover is to be conducted by qualified personnel only. Only qualified, trained personnel who are aware of the hazards involved should remove instrument covers. Prevent operators from accessing any external circuits, test fixtures, cables or wherever hazardous voltages may be present. Failure to recognize and observe normal safety precautions could result in personal injury or death.

WARNING

ENVIRONMENTAL HEALTH & SAFETY: When any channel is connected to a hazardous voltage source, the instrument and the device under test should be supervised, following local EHS practices to restrict access.







Environmental Conditions

Keysight 34980A is designed for indoor use in an installation category II and low condensation environment. Table below shows the general environmental conditions for this instrument. Refer to the product data sheet at <https://literature.cdn.keysight.com/litweb/pdf/5989-1437EN.pdf> for more information on the instrument general specifications.

General specifications	Requirement
Temperature	Operating condition: 0°C to 55°C Storage condition: -40°C to 70°C
Humidity	Maximum Relative Humidity (non-condensing): 80% RH up to 40°C, decreases linearly to 37% RH at 55°C ^[a]
Altitude	Up to 2,000 m
Pollution degree	1 or 2

[a] From 40°C to 55°C, the maximum % Relative Humidity follows the line of constant dew point.

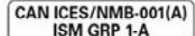
Regulatory Markings

	<p>The CE mark is a registered trademark of the European Community. This CE mark shows that the product complies with all the relevant European Legal Directives.</p>		<p>The UK conformity mark is a UK government owned mark. Products showing this mark comply with all applicable UK regulations.</p>	<p>CAN ICES/NMB-001(A)</p> <p>This indicates that this ISM device complies with the Canadian ICES-001. Interference-Causing Equipment Standard for industrial, scientific and medical (ISM) equipment. Matériel industriel, scientifique et médical (ISM)</p>	 <p>The Keysight email address is required by EU directives applicable to our product.</p> <p>ISM 1-A</p> <p>This is a symbol of an Industrial Scientific and Medical Group 1 Class A product. (CISPR 11, Clause 5)</p>
	<p>The CE mark is a registered trademark of the European Community. This CE mark shows that the product complies with all the relevant European Legal Directives.</p> <p>ICES/NMB-001 indicates that this ISM device complies with the Canadian ICES-001.</p> <p>Cet appareil ISM est conforme à la norme NMB-001 du Canada.</p> <p>ISM GRP:1 Class A indicates that this is an Industrial Scientific and Medical Group 1 Class A product.</p>		<p>This symbol is a South Korean Class A EMC Declaration. This is a Class A instrument suitable for professional use and in electromagnetic environment outside of the home.</p>	 <p>This is a combined marking to indicate product compliance with the Industry Canadian Interference-Causing Equipment Standard (ICES/NMB-001). This is also a symbol of an Industrial Scientific and Medical Group 1 Class A product (CISPR 11, Clause 5).</p>	 <p>The RCM mark is a registered trademark of the Australian Communications and Media Authority.</p>



This symbol indicates the time period during which no hazardous or toxic substance elements are expected to leak or deteriorate during normal use. Forty years is the expected useful life of the product.



This instrument complies with the WEEE Directive (2002/96/EC) marking requirement. This affixed product label indicates that you must not discard this electrical or electronic product in domestic household waste.



Universal recycling symbol.

IP x y

This mark indicates product has been designed to meet the requirements of "IP x y", where "x" is the solid particle protection and "y" is the liquid ingress protection.

Waste Electrical and Electronic Equipment (WEEE) Directive 2002/96/EC

The crossed out wheeled bin symbol indicates that separate collection for waste electric and electronic equipment (WEEE) is required, as obligated by the EU DIRECTIVE and other National legislation.

Please refer to [keysight.com/go/takeback](https://www.keysight.com/go/takeback) to understand your Trade in options with Keysight in addition to product takeback instructions.



Sales and Technical Support

To contact Keysight for sales and technical support, refer to the support links on the following Keysight websites:

- www.keysight.com/find/xxxx
(product-specific information and support, software and documentation updates)
- www.keysight.com/find/assist
(worldwide contact information for repair and service)

THIS PAGE HAS BEEN INTENTIONALLY LEFT BLANK.

Table of Contents

Safety Symbols	3
Additional Safety Notices	4
Environmental Conditions	8
Regulatory Markings	9
Waste Electrical and Electronic Equipment (WEEE) Directive 2002/96/EC	11
Sales and Technical Support	11
RF Multiplexer Switch Modules	15
Operating Considerations	16
34941A and 34942A SCPI Programming Examples	18
34941A and 34942A Simplified Schematic	20

THIS PAGE HAS BEEN INTENTIONALLY LEFT BLANK.

RF Multiplexer Switch Modules

This User's Guide covers the following two plug-in modules for the Keysight 34980A Multifunction Switch/Measure Unit:

34941A	Quad 1x4 50 Ω 3GHz RF multiplexer
34942A	Quad 1x4 75 Ω 1.5GHz RF multiplexer

These modules provide high density radio frequency (RF) signal switching, with four independent 1x4 multiplexer banks in each module.

Both modules contain four banks of latching switches. Each bank consists of three Form C relays (see the simplified schematic on [page 20](#)). To create a larger switching configuration, you can connect the banks in this module *and* connect to banks in *other* RF MUX modules. For example, you can create up to 1x97 RF MUX in a single 34980A mainframe.

The important differences between the two RF MUX modules lie in their characteristic impedance and their use of connectors (external cables are *not* provided with the module):

- The 34941A – the 50- Ω version – uses SMA connectors.

When installing SMA cables on the 34941A module, it is recommend that you tighten them to 0.8 - 1.1 Nm (7-10 in-lbs) of torque.

CAUTION

SMA connectors are easily damaged, especially when tightening a neighboring connector with a wrench. To help prevent damage and contamination, do not remove a connector's protective cap until immediately prior to installing a cable on that connector.

- The 34942A – the 75- Ω variation – uses Mini SMB connectors.

NOTE

For the 34942A, it is recommended that you use gold-plated straight plug connectors (75 Ω Miniature SMB). Because of the space constraints between connectors on this module, right-angle plugs and SMB adapters are not recommended.

Operating Considerations

Electrical Considerations

See the *Introduction to the Plug In Modules* chapter of the 34980A Mainframe User's Guide for detailed environmental operating conditions for the 34980A mainframe and its installed modules. That guidance sets maximum per channel current and power ratings at rated voltage for pollution degree 1 (dry) and pollution degree 2 (possible condensation) conditions, for each of the GP modules.

Signal Connections

The RF MUX modules do not connect to the analog buses. Instead, all signal connections are made through the visible connectors via external cables. Each visible connector on an RF MUX module is labeled with a number (11 through 44), that represents a channel you can close programmatically from the front panel or with using the Web Browser Interface. When you close a channel on the RF MUX modules you automatically close all relays that create a direct path to the Common of a bank.

Channel Relay Operation

With RF MUX switches, you cannot open switches programmatically. You can only close a channel. When you close one channel, another channel automatically opens. Therefore, only one channel relay in each bank is closed at any time.

Electrical Isolation

You can configure each bank on the RF MUX modules to be either isolated or chassis-grounded. The modules come with chassis-grounded metal shoulder washers installed on all connectors in each bank of relays. If you want to isolate a bank from the other banks and from chassis-ground, you must remove the five metal washers in that bank and replace them with the provided plastic shoulder washers.

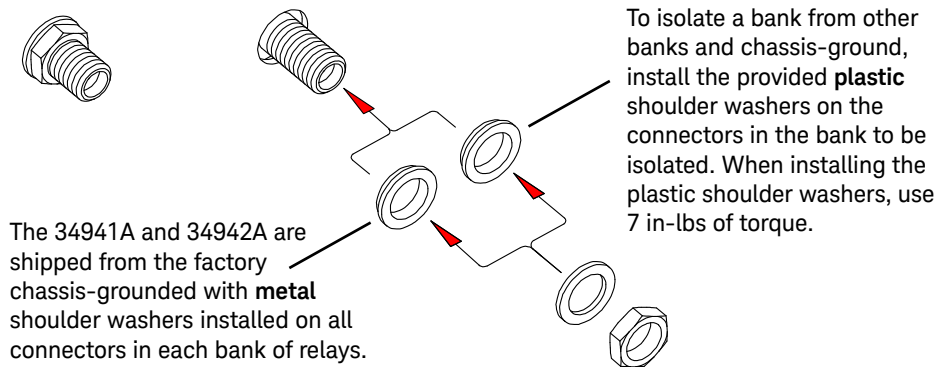

34941A and 34942A SCPI Programming Examples

The programming examples below provide you with SCPI command examples to use for actions specific to the RF MUX switch modules.

The slot and channel addressing scheme used in these examples follow the form **sccc** where **s** is the mainframe slot number (1 through 8) and **ccc** is the channel number. For information on specific configurations, refer to the simplified schematic on [page 20](#).

For complete information on the SCPI commands used to program the 34980A, refer to the *Keysight 34980A Programmer's Reference* which can be downloaded from www.keysight.com/find/34980A.

Example: Closing channels You can only *close* channels on the RF MUX modules. When you close a channel, any already-closed channels open automatically. The relays switch in sequence to avoid momentary connection of the wrong input to the multiplexer output. The following command closes channel 03 on Bank 1 of an RF MUX module in slot 5.

```
ROUTe:CLOSe (@5103)
```

Example: Querying channels for open or close state The following commands returns the close or open state of channel 33 of a module in slot 5.

```
ROUT:CLOSe? (@5033)
```

```
ROUT:OPEN? (@5033)
```

Example: Querying the system for module identify The following command returns the identify of the module installed in slot 7.

```
SYSTem:CTYPe? 7
```

Example: Reading the cycle count for a relay On these modules, each bank consists of two *leaf* relays and one *tree* relay (see the simplified schematic on [page 20](#)). The module stores the cycle count for each of the three relays on all four banks. The cycle count is the greater of the three values on the specified bank (i.e., reflecting the cycle count for the entire bank). Therefore, the count for Channels 101, 102, 103, and 104 will *always* be equal. The following statement reads back the number of completed cycles for the channels 101 and 202 on a module installed in slot 6.

```
DIAGnostic:RELAy:CYCLes? (@6101,6202)
```

Example: Clearing the cycle count for a relay The following command resets the cycle count on the channels 103 and 201 for a module in slot 1.

Note that clearing the cycle count on a specific channel will clear the count on *all* three relays in the corresponding bank.

DIAGnostic:RELAY:CYCLes:CLEar (@1103,1201)

Example: Resetting module to power-on state The following command resets a module in slot 4 to its power-on state.

SYSTem:CPON 4

34941A and 34942A Simplified Schematic

Both the 34941A and 34942A modules are configured alike. Each contains four banks of latching switches. Each bank consists of three Form C relays.

The front panel of the two RF MUX modules are similar with channel labels in the same positions, the unique product number on the left, and the product description on the right.

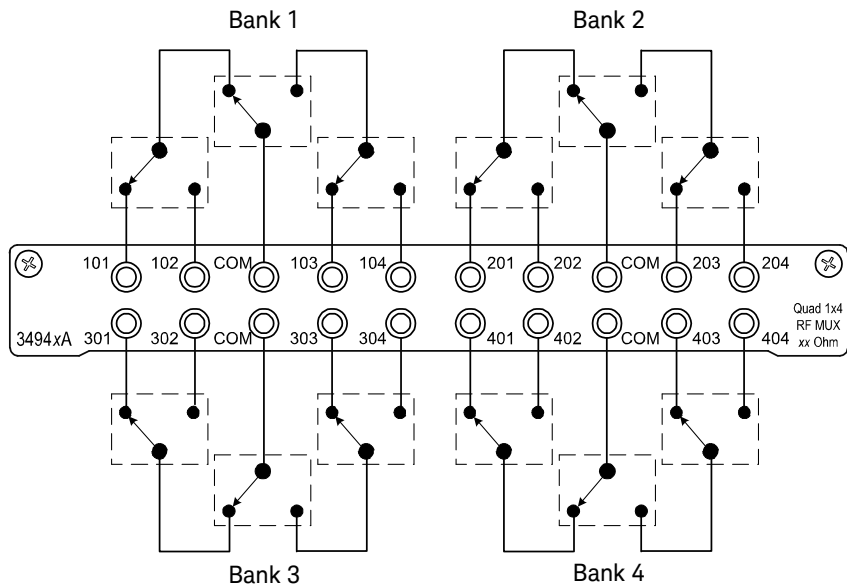

Index

C

channel relays, 16
connectors, 15

D

description, 15

E

electrical isolation, 17

G

grounding, 17

M

mini SMB connectors, 15
module descriptions, 15
module impedance
 34941A, 15
 34942A, 15

P

programming examples, 18

R

relay operation, 16

S

safety notices, 4
simplified schematics, 20
SMA connectors, 15

THIS PAGE HAS BEEN INTENTIONALLY LEFT BLANK.



This information is subject to change without notice. Always refer to the Keysight website for the latest revision.

© Keysight Technologies 2008-2022
Edition 4, Aug 2022

Printed in Malaysia



34980-90041

www.keysight.com