

ESPEC

Bench-Top Type Temperature (& Humidity) Chamber

SH-221 • 241 • 261 • 641 • 661
SU-221 • 241 • 261 • 641 • 661



Compact design for personal use Ready to network with your computer.

Introducing a new lineup of our Bench-top Type Temperature (& Humidity) Chamber Series.

Our latest models achieve superb performance in a compact size,
and attains temperatures as low as $-20^{\circ}\text{C}/-40^{\circ}\text{C}/-60^{\circ}\text{C}$, with capacity of 20L or 60L.

They provide high performance and quality features with new capabilities for integration
with our information network system, <E-PILOT 21>.

It is useful for centralized control and data processing, as well as operating chamber control
and specimen measurement at the same time. All brought to you by ESPEC.





Viewing window and stand are optional



SU 60L model

- **Small size & light weight**

Chamber size is a compact 440W × 560H × 695Dmm (excluding protrusion), while its weight is only 66kg. Ensured the inside test area dimension at 300W × 300H × 250Dmm. (SU-221•241 100VAC model) .

- **Compact design with high performance ——— SH-661**

The new model SH-661 achieves -60 to +150°C/ 30 to 95%rh in a compact design, and shows outstanding performance than any other previous bench-top models.

- **Select your optimum chamber from a full variation**

The series provide six variations in temperature (& humidity) range of -20°C/-40°C/-60°C to +150°C (and 30 to 95%rh), and two capacities of 20L or 60L, with a total of 10 models altogether. A wide temperature (& humidity) range is offered in a bench-top model, enabling you to choose the right chamber.



SH-661

User-friendly

- **Newly developed refrigeration system that saves energy consumption up to 55%**

Our exclusive refrigerator capacity variable control system saves up to 55% energy consumption compared to our previous model.

- **Optional stand for space-saving layout**

For use in limited space, we provide an exclusive stand with casters for stacking up to three chambers.

*Be sure to secure the stand onto the floor with earthquake resistant fittings for your safety when using stand.

- **Recycling**

Molded resin and metal parts which can be recycled are clearly marked to make recyclable materials easier to identify during disassembly.

- **Ozone layer protection**

The HFC refrigerant used is completely safe for the ozone layer.



Cable port flug (Material marked)

User-friendly



- **Cable ports for running in wires**

Each one 25mm diameter cable port is standard equipped on both sides of the chamber for wiring to the specimen. We also provide 50mm, 100mm diameter port and flat type cable port.

- **Cartridge tank for easy water supply**

Once water is supplied into the tank, continuous operation is maintained for three days. Maintenance can be done easily from the front side. Additional water tank connection is available for further extended operation. (SH model)

- **Right-opening door (optional)**

You may want to change the direction of opening the door to fit the installation space.

- **Viewing window for observation (optional)**

A large window provides a clear view of your specimen during testing.
(215W × 215Hmm for 20L model,
215W × 315Hmm for 60L model)

*The basic specification of the chamber will be modified.



Water supply tank



Right-opening door



Viewing window: 20L model

- **Flexible Computer Interface**

Communication port RS-485 is equipped as standard. You can select RS-232C, GP-IB, and E-BUS communication port as option.

Control operation

● Easy operation with 9 keys

Temperature & humidity setting, timer setting, and upper/lower temperature & humidity limit alarm setting can be done with simple key operation.

● Programming operation of up to 9 steps

In addition to constant setting, programming instrumentation is equipped to allow programmable operation to a maximum of 9 steps per pattern and the rise and fall gradient of temperature (& humidity) to be set to meet the application requirements for temperature characteristic testing and temperature (& humidity) cycle testing. Maximum 99-time repeat function and operational setting function after program execution are just two of the various functions offered.



Description of program function

Program function	Pattern
Step program	
Temperature gradient program	
Termination program	

*1 Sets a program repetition frequency between a range of 1 and 99.

*2 Selects HOLD, CONST or OFF when a program is over.

Network

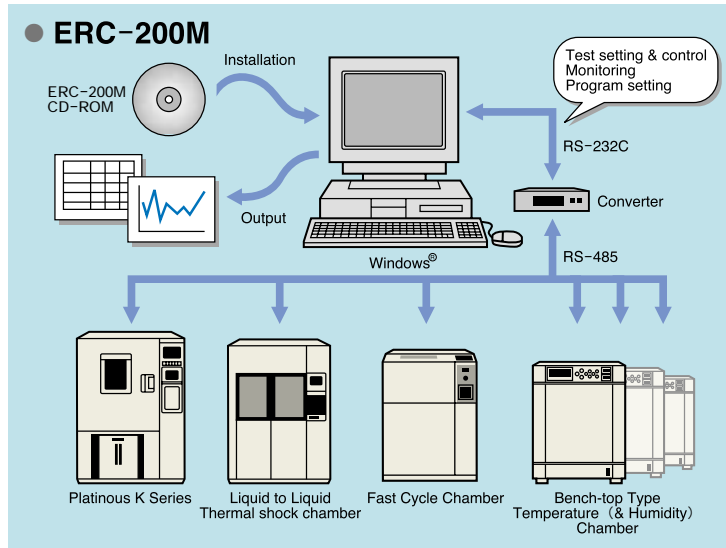

● Communication Network of Environmental Test Chambers

Bench-top type temperature & humidity chamber incorporates the communication port RS-485 as standard to cope with the [E-PILOT 21], which is a newly developed centralized control system. [E-PILOT 21] not only serves as a system for centralized control of environmental chambers, but also establishes an open network including specimen measurement function and remote chamber main-tenance function.

E-PILOT «ERC-100S»

The high-level of functions offered by ERC-200M is included in a non-networked package, meant for a single chamber to be interfaced with your personal computer. The RS-232C communications port option is required, but the software is free.

●For one-to-one users

If you are not ready to establish a network of test chambers, this software would be an ideal trial of the capabilities of our ERC-200M package.

●Freeware

ERC-100S can be downloaded from our website for free at www.espec.co.jp/english.

E-PILOT «ERC-200M»

Control, monitoring, programming, and datalogging for up to 16 ESPEC chambers can be performed through a single PC. RS-485 from ESPEC chambers connect via a serial bus converter to RS-232C on the PC.

●Remote operation

Have full control of test chambers while sitting in your office.

●Potential savings

Because the ERC-200M allows program operations to be run directly from the PC, test chambers with less-expensive single-setting controllers can be used.

●E-BUS version available

For existing units with E-BUS system, ERC-100M is available.

* The series of application softwares and network systems are provided on a separate basis from the chamber.

E-PILOT «ERC-300M»

Set up an Intranet Web-PILOT site to allow monitoring of up to 16 chambers through one PC (possible with E-BUS communications system). Monitor the settings and operation of your chambers from any PC on the Intranet. Web-based method allows display of chamber information across many computer platform types.

E-PILOT «Lab-VIEW»

For use in applications where LabVIEW software is needed to integrate ESPEC chambers with other equipment such as power supplies or measurement equipment. Optional GP-IB (IEEE-488) communications interface is required.

●Driver software to connect test chambers are provided for free

Lab VIEW drivers are available to give the basic building blocks for addressing ESPEC equipment. Drivers required for connecting ESPEC products to a personal computer is provided for free. For further information, please contact your nearby ESPEC sales office.

CMS-J30

This is a fully customizable system that provides centralized control, centralized monitoring, remote operation and specimen data management of ESPEC products (up to 32 units of which 16 are dedicated to centralized monitoring) by the use of a PC. (E-BUS compatible)

* Please contact us for further information.

Model	SH-221	SH-241	SH-261	SH-641	SH-661	
Power supply	100VAC 1φ 50/60Hz 115VAC 1φ 60Hz 220VAC 1φ 50/60Hz 230VAC 1φ 50Hz			100VAC 1φ 50/60Hz 200VAC 1φ 50/60Hz 220VAC 1φ 50/60Hz 230VAC 1φ 50Hz		
Maximum current *1	100V	12.5A	13.5A	18.0A		
	115V	12.0A	13.0A	—		
	200V	—			10.0A	
	220V	7.0A	7.5A	9.0A		
	230V	6.5A	7.0A	8.5A		
Temperature and humidity control system	Balanced Temperature & Humidity Control system (BTHC system)					
Operable ambient temperature range	+5 to +35°C (+41 to +95°F)					
Noise	At 1m from front of chamber, 1.2m from floor: 55dB (depending on environment)					
Performance *2	Temperature range *3	-20 to +150°C (-4 to +302°F)	-40 to +150°C (-40 to +302°F)	-60 to +150°C (-76 to +302°F)	-40 to +150°C (-40 to +302°F)	-60 to +150°C (-76 to +302°F)
	Humidity range *3	30 to 95%rh (Refer to diagram of temperature & humidity control range)				
	Temperature fluctuation *3	±0.3°C (-20 to +100°C) [±0.54°F (-4 to +212°F)] ±0.5°C (+100.1 to +150°C) [±0.9°F (+212.1 to +302°F)]	±0.3°C (-40 to +100°C) [±0.54°F (-40 to +212°F)] ±0.5°C (+100.1 to +150°C) [±0.9°F (+212.1 to +302°F)]	±0.3°C (-60 to +100°C) [±0.54°F (-76 to +212°F)] ±0.5°C (+100.1 to +150°C) [±0.9°F (+212.1 to +302°F)]	±0.3°C (-40 to +100°C) [±0.54°F (-40 to +212°F)] ±0.5°C (+100.1 to +150°C) [±0.9°F (+212.1 to +302°F)]	±0.3°C (-60 to +100°C) [±0.54°F (-76 to +212°F)] ±0.5°C (+100.1 to +150°C) [±0.9°F (+212.1 to +302°F)]
	Humidity fluctuation *3	±3.0%rh				
	Temperature uniformity *3	±0.5°C (-20 to +100°C) [±0.9°F (-4 to +212°F)] ±0.8°C (+100.1 to +150°C) [±1.44°F (+212.1 to +302°F)]	±0.5°C (-40 to +100°C) [±0.9°F (-40 to +212°F)] ±0.8°C (+100.1 to +150°C) [±1.44°F (+212.1 to +302°F)]	±0.5°C (-60 to +100°C) [±0.9°F (-76 to +212°F)] ±0.8°C (+100.1 to +150°C) [±1.44°F (+212.1 to +302°F)]	±0.5°C (-40 to +100°C) [±0.9°F (-40 to +212°F)] ±0.8°C (+100.1 to +150°C) [±1.44°F (+212.1 to +302°F)]	±0.5°C (-60 to +100°C) [±0.9°F (-76 to +212°F)] ±0.8°C (+100.1 to +150°C) [±1.44°F (+212.1 to +302°F)]
	Humidity uniformity *3	±3.0%rh				
	Temperature heat-up rate	-20 to +150°C within 55 min	-40 to +150°C within 60 min	-60 to +150°C within 70 min	-40 to +150°C within 70 min	-60 to +150°C within 80 min
	Temperature pull-down rate	+20 to -20°C within 20min	+20 to -40°C within 50min	+20 to -60°C within 70min	+20 to -40°C within 60min	+20 to -60°C within 90min
	Lowest attainable temperature	-20°C (-4°F)	-40°C (-40°F)	-60°C (-76°F)	-40°C (-40°F)	-60°C (-76°F)
	Construction	Exterior material	Cold rolled and rust-proof steel plate, Melamine finish			
Interior material		18-8 Cr-Ni stainless steel plate (SUS 304)				
Insulation		Rigid polyurethane foam, Glass wool				
Door		one-panel door (right handle, left hinge)				
Instrumentation panel		Temperature & humidity indicator controller, Overheat protector, Overcool protector				
Heater		Nichrome-stripped wire heater 400W			600W	
Humidifier		18-12-2.5 Cr-Ni-Mo stainless steel sheathed heater 250W				
Refrigeration system		Mechanical single-stage refrigerator system			Mechanical cascade condenser refrigeration system	
Cooler		Plate fin cooler				
Refrigerator		Compressor: Air-cooled hermetically sealed compressor, Condenser: Air-cooled condenser, Expansion mechanism: Capillary tube				
Refrigerator capacity	400W			400W+400W		
Refrigerant	R404A			R404A, R23		
Fittings	Connecting terminal for temp & humid recorder terminal, Specimen power supply control terminal, External alarm terminal, External output terminal, Cable ports, Power cord/ plug, Drain pipe, Water supply tank, Quick on/ off plug for water drainage, Water level sensor for water supply tank/ drain socket for tank					
Dimensions	Inside dimensions (W×H×D mm/ in)	300×300×250/ 12×12×10 (excluding protrusions)			400×400×400/ 16×16×16 (excluding protrusions)	
	Outside dimensions (W×H×D mm/ in)	440×630×695/ 17.6×25.2×27.8 (730/ 28.7D when including protrusions)			440×630×785/ 17.6×25.2×31.4 (825/ 33D when including protrusions)	
Capacity (L)	22.5			64		
Weight (kg)	71 (76 for 115, 220, 230V)			100		

*1 At +23°C ambient temperature, value at stable voltage application. For SH-641/ 661, make sure to check the capability of your power equipment in advance.

*2 At +23°C ambient temperature, value at stable voltage application with no specimen. Lowest attainable temperature value at ambient of up to +30°C.

*3 In accordance with Standard for Performance of Humidity Chamber (JTM-K01-1998) of standard of Japan Testing Machinery Association.

Model	SU-221	SU-241	SU-261	SU-641	SU-661	
Power supply	100VAC 1φ 50/60Hz 115VAC 1φ 60Hz 220VAC 1φ 50/60Hz 230VAC 1φ 50Hz			100VAC 1φ 50/60Hz 200VAC 1φ 50/60Hz 220VAC 1φ 50/60Hz 230VAC 1φ 50Hz		
Maximum current *1	100V	10.0A	13.5A	18.0A		
	115V	9.5A	13.0A	—		
	200V	—			10.0A	
	220V	6.0A	7.5A	9.0A		
	230V	5.5A	7.0A	8.5A		
Temperature control system	Balanced Temperature control system (BTC system)					
Operable ambient temperature range	+5 to +35°C (+41 to +95°F)					
Noise	At 1m from front of chamber, 1.2m from floor: 55dB (depending on environment)					
Performance *2	Temperature range *3	−20 to +150°C (−4 to +302°F)	−40 to +150°C (−40 to +302°F)	−60 to +150°C (−76 to +302°F)	−40 to +150°C (−40 to +302°F)	−60 to +150°C (−76 to +302°F)
	Temperature fluctuation *3	±0.3°C (−20 to +100°C) [±0.54°F (−4 to +212°F)] ±0.5°C (+100.1 to +150°C) [±0.9°F (+212.1 to +302°F)]	±0.3°C (−40 to +100°C) [±0.54°F (−40 to +212°F)] ±0.5°C (+100.1 to +150°C) [±0.9°F (+212.1 to +302°F)]	±0.3°C (−60 to +100°C) [±0.54°F (−76 to +212°F)] ±0.5°C (+100.1 to +150°C) [±0.9°F (+212.1 to +302°F)]	±0.3°C (−40 to +100°C) [±0.54°F (−40 to +212°F)] ±0.5°C (+100.1 to +150°C) [±0.9°F (+212.1 to +302°F)]	±0.3°C (−60 to +100°C) [±0.54°F (−76 to +212°F)] ±0.5°C (+100.1 to +150°C) [±0.9°F (+212.1 to +302°F)]
	Temperature uniformity *3	±0.5°C (−20 to +100°C) [±0.9°F (−4 to +212°F)] ±0.8°C (+100.1 to +150°C) [±1.44°F (+212.1 to +302°F)]	±0.5°C (−40 to +100°C) [±0.9°F (−40 to +212°F)] ±0.8°C (+100.1 to +150°C) [±1.44°F (+212.1 to +302°F)]	±0.5°C (−60 to +100°C) [±0.9°F (−76 to +212°F)] ±0.8°C (+100.1 to +150°C) [±1.44°F (+212.1 to +302°F)]	±0.5°C (−40 to +100°C) [±0.9°F (−40 to +212°F)] ±0.8°C (+100.1 to +150°C) [±1.44°F (+212.1 to +302°F)]	±0.5°C (−60 to +100°C) [±0.9°F (−76 to +212°F)] ±0.8°C (+100.1 to +150°C) [±1.44°F (+212.1 to +302°F)]
	Temperature heat-up rate	−20 to +150°C within 55 min	−40 to +150°C within 60 min	−60 to +150°C within 70 min	−40 to +150°C within 70 min	−60 to +150°C within 80 min
	Temperature pull-down rate	+20 to −20°C within 20min	+20 to −40°C within 50min	+20 to −60°C within 70min	+20 to −40°C within 60min	+20 to −60°C within 90min
	Lowest attainable temperature	−20°C (−4°F)	−40°C (−40°F)	−60°C (−76°F)	−40°C (−40°F)	−60°C (−76°F)
	Exterior material	Cold rolled and rust-proof steel plate, Melamine finish				
Interior material	18-8 Cr-Ni stainless steel plate (SUS 304)					
Insulation	Rigid polyurethane foam, Glass wool					
Door	one-panel door (right handle, left hinge)					
Instrumentation panel	Temperature indicator controller, Overheat protector, Overcool protector					
Heater	400W			600W		
Refrigeration system	Mechanical single-stage refrigerator system			Mechanical cascade condenser refrigeration system		
Cooler	Plate fin cooler					
Refrigerator	Compressor: Air-cooled hermetically sealed compressor, Condenser: Air-cooled condenser, Expansion mechanism: Capillary tube					
Refrigerator capacity	400W			400W+400W		
Refrigerant	R404A			R404A, R23		
Fittings	Connecting terminal for temp recorder terminal, Specimen power supply control terminal External alarm terminal, External output terminal, Cable ports, Power cord/ plug, Drain pipe					
Dimensions	Inside dimensions (W×H×D mm/ in)	300×300×250/ 12×12×10 (excluding protrusions)			400×400×400/ 16×16×16 (excluding protrusions)	
	Outside dimensions (W×H×D mm/ in)	440×560×695/ 17.6×25.2×27.8 (730/ 28.7D when including protrusions)		440×560×785/ 17.6×22.4×31.4 (825/ 33D when including protrusions)	540×660×890/ 21.6×26.4×35.6 (930/ 37.2D when including protrusions)	
Capacity (L)	22.5			64		
Weight (kg)	66 (71 for 115, 220, 230V)			95		

*1 At +23°C ambient temperature, value at stable voltage application. For SH-641/ 661, make sure to check the capability of your power equipment in advance.

*2 At +23°C ambient temperature, value at stable voltage application with no specimen. Lowest attainable temperature value at ambient of up to +30°C.

*3 In accordance with Standard for Performance of Humidity Chamber (JTM-K01-1998) of standard of Japan Testing Machinery Association.

TEMPERATURE & HUMIDITY CONTROL RANGE (SH type only)

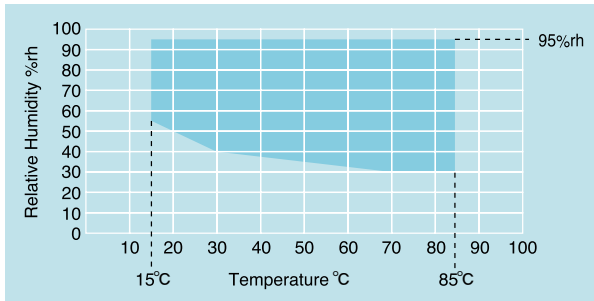

※At +23°C ambient temperature.

MODEL

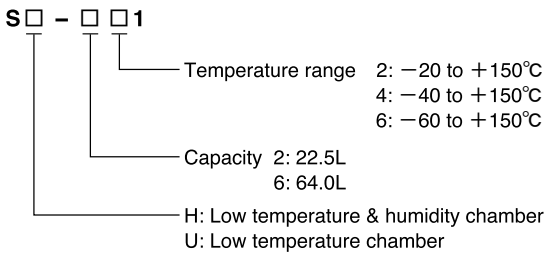

TEMPERATURE (& HUMIDITY) PROGRAM INDICATOR CONTROLLER

Model	ES-102
Operation mode	Program operation, Constant operation
Display	7-segment LED display
Setting	Mechanical key input
Program capacity	9 steps/ 1 pattern (1 to 99 repetitions)
Setting and indication ranges	Temp : -25 to +155°C (SH-221, SU-221) :-45 to +155°C (SH-241·641, SU-241·641) :-65 to +155°C (SH-261·661, SU-261·661) Humid : 0 to 100 %rh (SH only) Tim : 0 to 99 hours 59 minutes, 100 to 999 hours
Setting and indication resolution	Temp : 0.1°C Humid : 1%rh (SH only) Time : 1 minute (in one hour unit for over 100 hours)
Indication accuracy *	Temp : 0.5°C (Typ.) Humid : ±2%rh (Typ.) (SH only) Time : within 30 sec. per month
Input	Thermocouple type T (Copper/ Copper-Nickel)
Control	PID control
Communication function	RS-485
Auxiliary functions	Input burn-out detection function Upper and lower temperature (& humidity) limit alarm function Self-diagnostic function (watchdog timer) Alarm indication function Power failure protection function Timer function (automatic start/stop) Refrigerator capacity automatic control function
Battery	Lithium battery, 1

* At +23°C ±5°C ambient temperature

SAFETY DEVICES

- Leakage breaker for power supply
- Thermal fuse
- Boil dry protector (SH only)
- Short circuit protection fuse for control circuit
- Overheat protector
- Overcool protector
- Air circulator temperature switch
- Specimen power supply control terminals
- Refrigerator overload relay
- Inside chamber door switch
- Upper and lower temperature & humidity limit alarms (built inside temperature & humidity controller)
- Burn-out detection function (built inside temperature & humidity controller)
- Watchdog timer (built inside temperature & humidity controller)
- Refrigerator automatic delay circuit (built inside temperature & humidity controller)

SHELVES

- Load capacity (uniformly distributed load)
 - SH/ SU-221, 241, 261 500g
 - SH/ SU-641, 661 5kg
- Number of shelves
 - SH/ SU-221, 241, 261 5 (Shelf pitch 35mm)
 - SH/ SU-641, 661 5 (Shelf pitch 50mm)

ACCESSORIES

- Shelf 1
- Connector
 - 2P for connecting terminal for temp & humid recorder 2 (1 for SU)
 - 6P for connecting signal terminal 1
- Rubber plug for cable port 2
- Glass tube fuse 1
- Adaptor for socket 1 (100VAC, 115V AC only) (for SH/ SU-221, 241, 261)
- Wet-bulb wick 1 box (SH only)
- Humidifying tray drain hose 2m 1 (SH only)
- Water level sensor tank drain hose 0.3m 1 (SH only)
- Instruction manual 1
- Warranty 1



DANGER

- Do not use specimens which are explosive or inflammable, or which contain such substances. To do so could be hazardous, as this may lead to fire or explosion.
- Do not place corrosive materials in the chamber. If corrosive substances or humidifying water is used, the life of the unit may be significantly shortened.
- Do not place life forms or substances that exceed allowable heat generation.



CAUTION

- Be sure to read the instruction manual before operation.

DIMENSIONS

unit : mm (inch)

● SH-221·241

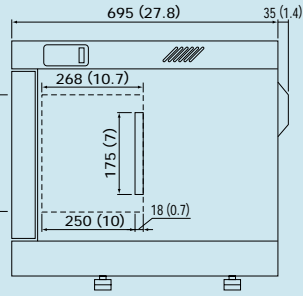
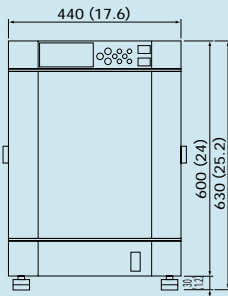
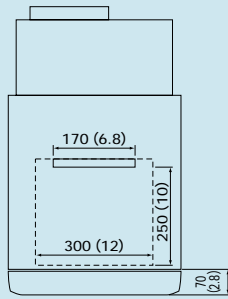

● SH-261

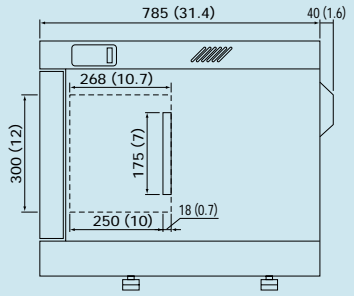
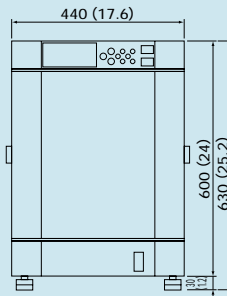
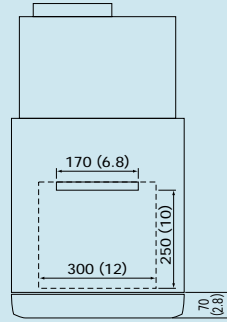

● SH-641·661

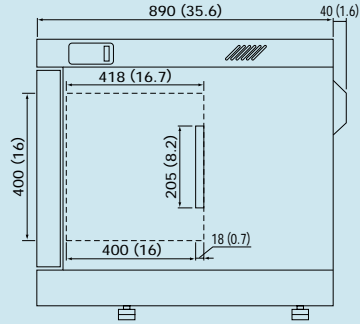
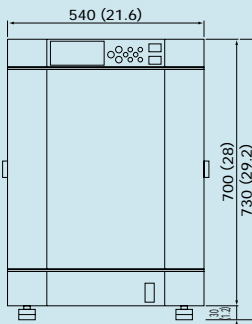
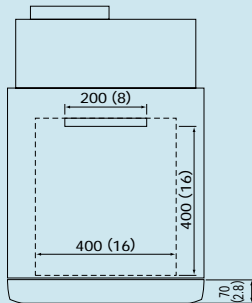

OPTIONS

Communication functions

Computer interface

- GP-IB
- RS-232C
- E-BUS

*Select one other than standard RS-485.

Communication cable

- RS-485 5, 10m
- GP-IB 2, 4m
- RS-232C 1.5, 3, 5, 10m
1.5, 3, 5, 10m for extension
- E-BUS 5, 10m

Temperature recorder

- SRJ25
- -100 to +200°C
 - 100mm
 - Portable type
 - 6 dots
 - (Thermocouple type T)
(Copper/ Copper-Nickel)
 - Digital
 - Free power supply
(100VAC to 240VAC)

Temperature & humidity recorder

- SRJ14 -100 to +150°C/
0 to 100%rh (for SH)
- SRJ12 -50 to +150°C/
0 to 100%rh (for SH)
- 100mm
 - Portable type
 - 6 dots
 - (Temperature: 5 dots
thermocouple type T
(Copper/ Copper-Nickel)
Humidity: 1 dot
DC1 to 5V)
 - Digital
 - Free power supply
(100VAC to 240VAC)



Wet-bulb temperature detecting terminal

Detects wet-bulb temperature inside the chamber. Equal electromotive force as Thermocouple type T (Copper/ Copper-Nickel).

Equipped with connector.

*Not available for SU

Thermocouple

Measures the temperature of specimens

- T (Copper/ Copper-Nickel)
- 2, 4, 6m

Viewing window

A window is installed on chamber door.

SH-221•241•261 W215×H215mm

SU-221•241•261 W215×H215mm

SH-641•661 W215×H315mm

SU-641•661 W215×H315mm

*The basic specification of the chamber will be modified.



Inner door

A glass door is provided inside the chamber door for observation.

* A wiper is equipped for the SH model.



SU model

Right-opening door

Door can be exchanged to a right hinged door.

*Not available with inner glass door option.



Cable port

Additional cable ports are provided on the wall of chamber.

- 25, 50, 100mm diameter
- Flat cable port

*One silicon sponge rubber port plug is equipped per one cable port.

* Basic specification of the chamber may not be effective when equipped with a cable port.



25mm diameter type 50, 100mm diameter type



flat type

Cable port rubber plug

The additional silicon sponge rubber port plug .

OPTIONS

Auxiliary water tank circuit

Automatic water supply circuit is equipped to replenish the standard tank from the auxiliary water tank.

- Supply water quality
pure water
(electrical conductivity 0.1~10 μ S/cm)
- Water supply pressure
4.9~19.6KPa (Gauge)

Auxiliary water tank

Auxiliary tanks are provided to replenish water to the standard tank.

Tray for auxiliary water tank

Protects water from leaking while supplying water from the auxiliary water tank.

Drain tank

Storage tank for drain water with a full indication buzzer.

Stand

This stand enhances mobility of the chamber and ease the work to load/unload the specimen. Stand for stacking two or three chambers save installation space.

* Be sure to secure the stand onto the floor with earthquake resistant fittings for your safety especially when using stand for two/ three chambers.



*Stand for three chambers is designated only for SH-221, 241, SU-221, 241.

Shelf

Auxiliary shelves on request.

SH/ SU-221•241•261

- Effective size 200W×150Dmm
- Load capacity
(uniformly distributed load) 500g

SH/ SU-641•661

- Effective size 300W×300Dmm
- Load capacity
(uniformly distributed load) 5kg

Specimen basket

- Size 206W×40H×156D mm
- Material 18-8 Cr-Ni stainless steel,
5 mesh metal basket



ESPEC CORP. <http://www.espec.co.jp/english>

Head Office

3-5-6, Tenjinbashi, Kita-ku, Osaka 530-8550, Japan

Tel: 81-6-6358-4741 Fax: 81-6-6358-5500

Europe Office

Tel: 49-6196-77-99980 Fax: 49-6196-77-99985

ESPEC NORTH AMERICA, INC.

Tel: 1-616-896-6100 Fax: 1-616-896-6150

ESPEC EVALUATION & TEST SYSTEMS, INC.

Tel: 1-408-433-2295 Fax: 1-408-433-2296

ESPEC ENVIRONMENTAL EQUIPMENT (SHANGHAI) CO., LTD.

Head Office

Tel: 86-21-58303322 Fax: 86-21-58661781

BEIJING Rep. Office

Tel: 86-10-64627025 Fax: 86-10-64627036

GUANGZHOU Rep. Office

Tel: 86-20-83317826 Fax: 86-20-83317825

SHENZHEN Rep. Office

Tel: 86-755-83674422 Fax: 86-755-83674228

SUZHOU Rep. Office

Tel: 86-512-68664007 Fax: 86-512-68601994

ESPEC (MALAYSIA) SDN. BHD.

Tel: 60-3-89451377 Fax: 60-3-89451287



JIS Q 9001:2000
Registration Number
JSAQ 004



JAB Certificate Number
R001



RE 009



ISO 14001 (JIS Q 14001)

Environmental Management System Assessed and Registered

ESPEC GROUP

ESPEC CORP.

ESPEC ENGINEERING CORP.

ESPEC KANSAI CORP.

ESPEC ENVIRONMENTAL TEST

TECHNOLOGY CENTER CORP.

ESPEC BUSINESS CREATE CORP.



051

ISO 9001/JIS Q 9001

Quality Management System Assessed
and Registered

ESPEC CORP. has been assessed by and registered in the Quality Management System based on the International Standard ISO 9001:2000 (JIS Q 9001:2000) through the Japanese Standards Association (JSA).

- Specifications are subject to change without notice due to design improvements.
- Windows[®] is a trademark or registered trademark of Microsoft Corporation in the U.S.A. and other countries. Other corporate names and trade names mentioned in this catalog are trademarks or registered trademarks.
- Printed on recycled paper.